



PRODUCT TECHNICAL DATASHEET

HST4(-R) Expansion anchor

Steel-to-concrete

Update: Feb-26



HST4(-R)

HST4(-R) low strength concrete

Page no:03

Page no:16

HST4 (-R) Wedge expansion anchor

High-performance expansion anchor

Anchor version



HST4(-R)
(M8-M20)



HST4(-R) DN
(M10-M12)



HST4(-R) BW
(M8 - M16)

Link to Instructions for use and Hilti Webpage

The instructions for use can be viewed using the link in the Instructions for Use table or through the QR code/link provided in the Hilti webpage table.

Instructions for use (IFU)

Anchor size	M8	M10	M12	M16	M20
HST4	IFU HST4-M8	IFU HST4- M10	IFU HST4- M12	IFU HST4- M16	IFU HST4- M20
HST4-R	IFU HST4-R M8	IFU HST4-R M10	IFU HST4-R M12	IFU HST4-R M16	IFU HST4-R M20
Filling set	Filling Set				

Link to Hilti Webpage

HST4	HST4-R	HST4 DN	HST4-R DN	HST4 BW	HST4-R BW



PRODUCT TECHNICAL DATASHEET



HST4(-R) Expansion anchor

Steel-to-concrete





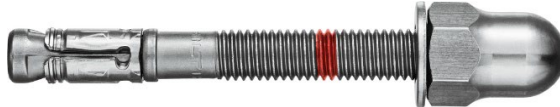



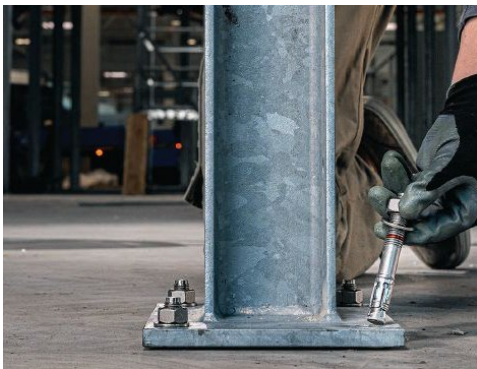



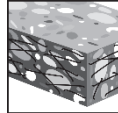
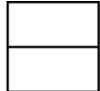
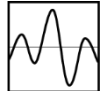

HST4 (-R) Wedge expansion anchor

High-performance expansion anchor

Anchor version	Benefits
 <p>HST4(-R) (M8-M20)</p>	<ul style="list-style-type: none"> - High capacity anchor with ability to be used in reduced member thickness, small spacing and edge distances - Suitable for uncracked and cracked concrete C12/16 to C90/105 - Tested and approved for structural seismic design with ETA C1/C2 assessment
 <p>HST4(-R) DN (M10-M12)</p>	<ul style="list-style-type: none"> - Longer embedment depth options to gain higher resistance, closer distance to the edge or smaller spacing - Full design flexibility with variable embedment depth and edge & spacing - Faster and reliable installation thanks to approved non-cleaning and adaptive torquing tool
 <p>HST4(-R) BW (M8 - M16)</p>	<ul style="list-style-type: none"> - Dome-nut variant available for more aesthetic application finish - Product length identification mark facilitates quality control and inspection

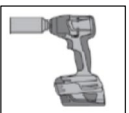
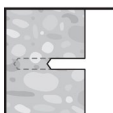

Base material	Load conditions
 <p>Concrete (uncracked)</p>  <p>Concrete (cracked)</p>  <p>Steel fiber reinforced concrete (SFRC)</p>	 <p>Static/ quasi-static</p>  <p>Seismic C1/C2</p>  <p>Shock BZS-CH</p>  <p>Fire resistance</p>

Drilling, cleaning, setting	Other information
 <p>Hammer drilled holes (with no cleaning)</p>  <p>Diamond drilled holes</p>  <p>Hollow drill-bit drilling</p>  <p>Impact wrench with adaptive torque module</p>	 <p>Variable embedment depth</p>  <p>ETA Working life 100/120 years¹⁾</p>  <p>PROFIS Engineering software</p>  <p>Steel to concrete Handbook</p>

¹⁾ 100 and 120 years approved only for HST4-R anchor



Linked Approvals/Certificates

Approvals/certificates

Approval no	Application / loading condition	Authority / Laboratory	Date of issue	Date of expiry
<u>ETA-21/0878</u>	Static and quasi-static / Seismic / Fire (50 years HST4 and 100 years HST4-R)	CSTB, Marne-la-Vallée	09-10-2025	-
<u>ETA-25/1042</u>	Static and quasi-static / Seismic / Fire (HST4-R 120 years)	CSTB, Marne-la-Vallée	01-12-2025	-
<u>UES-ER-815</u>	Static and quasi-static	IAPMO UES, USA	09-09-2025	31-08-2026
<u>GS 6.1/22-065-3-r1</u> (HST4-R)	Fire data ZTV-ING Tunnel	MFPA, Leipzig	30-11-2023	-
<u>BZS D 24-602</u> (HST4-R)	Shock approval	FOCP, Spiez	25-08-2024	31-12-2033

Fastener special dimensions

Anchor size			M8	M10	M12	M16	M20
Maximum length of anchor	L	[mm]	115	180	260	260	260
Outer diameter of washer	$d_w \geq$	[mm]	16	20	24	30	37
Outer diameter of big washer version (BW)	$d_w \geq$	[mm]	24	30	37	50	-

HST4(-R) (M8-M16)

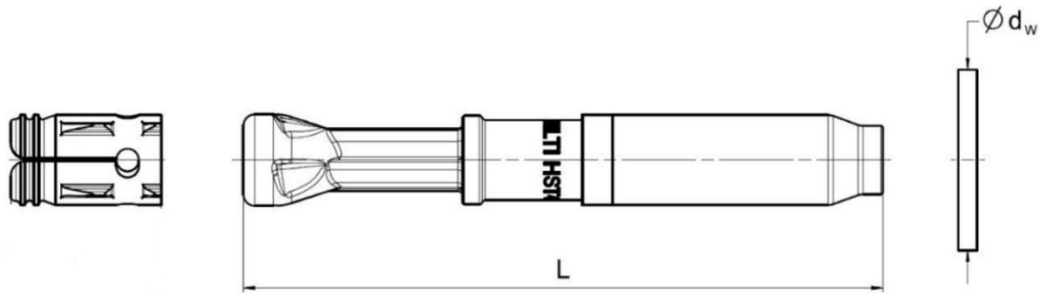

HST4(-R) M20

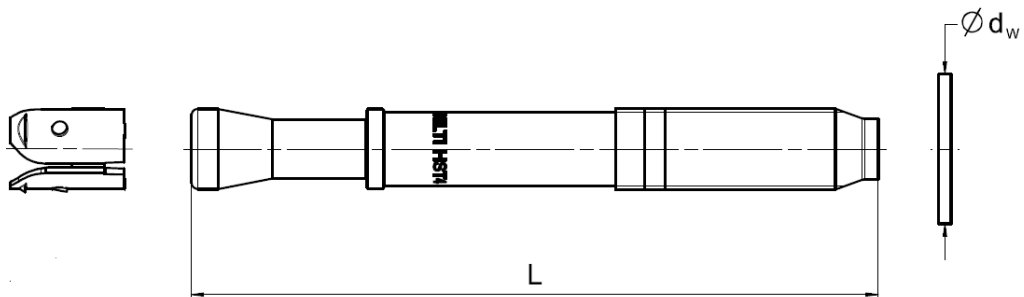

Dimensions of the Dome nut

Anchor size		M10	M12	
Length of dome nut thread	$L_{\text{thread,min}}$	[mm]	16,8	17,8
Length of dome nut	$L_{\text{DN,min}}$	[mm]	21,9	24,0

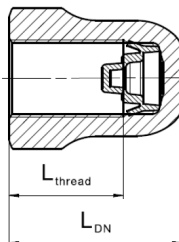

Hilti filling set with Injection mortar Hilti HIT-HY...

Dimensions filling washer

Anchor size			M8	M10	M12	M16	M20
Diameter	d_{vs}	[mm]	38	42	44	52	60
Height filling washer	h_{vs}	[mm]	5	5	5	6	6
Height filling washer and spherical washer	h_{fs}	[mm]	8	9	10	11	13

Sealing washer

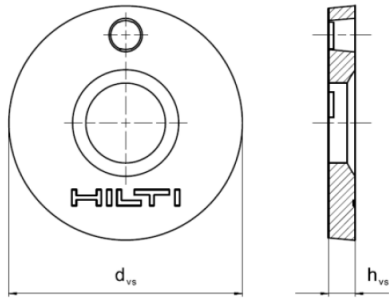

Spherical washer

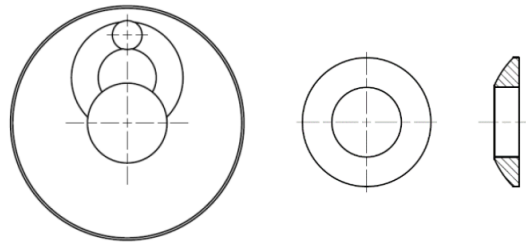

Filling Set

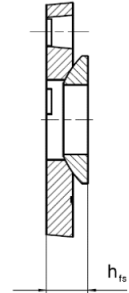

Static and quasi-static loading based on ETA-21/0878. Design according to EN 1992-4

All data in this section applies to:

- Correct setting (see setting instruction)
- Single anchor
- Concrete C20/25 with and without steel fibers (SFRC)
- No edge distance and spacing influence (see table with characteristic distances)
- Characteristic spacing and edge distance for splitting failure only applies for uncracked concrete.
- For cracked concrete only the characteristic spacing and edge distance for concrete cone failure are decisive
- Minimum base material thickness (see setting detail table)
- Data given below are for 50 Years Working Life
- Embedment depth, as specified in the table of this section
- Anchor material, as specified in the tables of this section
- Drilling method, as specified in the tables of this section
- Recommended loads: With overall partial safety factor for action $\gamma = 1,4$.

Note: Embedment depths $h_{ef} < 40$ mm are applicable only for fastening of redundant non-structural systems as addressed in EN 1992-4, Clause 7.3 and CEN/TR 17079. For other types of fastenings please increase the embedment depth.

For specific design cases refer to [PROFIS Engineering](#)

Design resistance (Hammer-drilled holes, hammer-drilled holes with Hilti hollow drill bit for HST4 and HST4-R & diamond-cored holes only for HST4-R)

Anchor size		M8			M10			M12			M16			M20		
Effective anchorage depth	h_{ef} [mm]	30 ¹⁾	47	90	30 ¹⁾	60	100	40	70	125	65	85	160	101	120	180
Uncracked concrete																
Tension	$\frac{HST4}{HST4-R}$ N_{Rd} [kN]	5,4	10,6	12,7	5,8	16,4	20,0	9,6	22,2	28,0	19,8	29,7	36,7	33,3	33,3	33,3
		5,4	10,6	12,7	6,2	17,6	21,3	9,6	22,2	30,7	19,8	29,7	40,0	33,3	33,3	33,3
Shear	$\frac{HST4}{HST4-R}$ V_{Rd} [kN]	11,0	13,0	13,0	10,8	19,8	19,8	23,9	29,9	29,9	50,3	50,3	50,3	67,1	67,1	67,1
		11,0	13,9	13,9	11,6	22,0	22,0	23,9	33,0	33,0	57,9	57,9	57,9	77,8	77,8	77,8
Cracked concrete																
Tension	$\frac{HST4}{HST4-R}$ N_{Rd} [kN]	3,8	7,4	8,0	4,4	12,3	12,7	6,7	15,5	18,7	13,9	20,8	25,3	23,3	23,3	23,3
		3,8	7,3	7,3	4,4	12,3	13,3	6,7	15,5	18,7	13,9	20,8	26,6	23,3	23,3	23,3
Shear	$\frac{HST4}{HST4-R}$ V_{Rd} [kN]	7,7	13,0	13,0	8,1	19,8	19,8	16,8	29,9	29,9	41,7	50,3	50,3	67,1	67,1	67,1
		7,7	13,9	13,9	8,1	22,0	22,0	16,8	33,0	33,0	41,7	57,9	57,9	74,6	77,8	77,8

Recommended loads (Hammer-drilled holes, hammer-drilled holes with Hilti hollow drill bit for HST4 and HST4-R & diamond-cored holes only for HST4-R)

Anchor size		M8			M10			M12			M16			M20		
Effective anchorage depth	h_{ef} [mm]	30 ¹⁾	47	90	30 ¹⁾	60	100	40	70	125	65	85	160	101	120	180
Uncracked concrete																
Tension	$\frac{HST4}{HST4-R}$ N_{rec} [kN]	¹⁾	7,5	9,0	¹⁾	11,7	14,3	6,8	15,8	20,0	14,2	21,2	26,2	23,8	23,8	23,8
		¹⁾	7,5	9,0	¹⁾	12,6	15,2	6,8	15,8	21,9	14,2	21,2	28,6	23,8	23,8	23,8
Shear	$\frac{HST4}{HST4-R}$ V_{rec} [kN]	¹⁾	9,3	9,3	¹⁾	14,2	14,2	17,1	21,4	21,4	35,9	35,9	35,9	47,9	47,9	47,9
		¹⁾	9,9	9,9	¹⁾	15,7	15,7	17,1	23,6	23,6	41,4	41,4	41,4	55,5	55,5	55,5
Cracked concrete																
Tension	$\frac{HST4}{HST4-R}$ N_{rec} [kN]	¹⁾	5,3	5,7	¹⁾	8,8	9,0	4,8	11,1	13,3	9,9	14,9	18,1	16,7	16,7	16,7
		¹⁾	5,2	5,2	¹⁾	8,8	9,5	4,8	11,1	13,3	9,9	14,9	19,0	16,7	16,7	16,7
Shear	$\frac{HST4}{HST4-R}$ V_{rec} [kN]	¹⁾	9,3	9,3	¹⁾	14,2	14,2	12,0	21,4	21,4	29,8	35,9	35,9	47,9	47,9	47,9
		¹⁾	9,9	9,9	¹⁾	15,7	15,7	12,0	23,6	23,6	29,8	41,4	41,4	53,3	55,5	55,5

¹⁾ Please refer "Requirements for redundant fastening" section

Design resistance (Diamond-cored holes only for HST4)

Anchor size			M8			M10			M12			M16			M20			
Effective anchorage depth	h_{ef}	[mm]	30 ¹⁾	47	90	30 ¹⁾	60	100	40	70	125	65	85	160	101	120	180	
Uncracked concrete																		
Tension	HST4	N_{Rd}	[kN]	5,4	8,2	8,8	5,4	15,2	20,0	8,3	19,2	20,0	17,2	25,7	30,7	33,3	33,3	33,3
Shear	HST4	V_{Rd}	[kN]	11,0	13,0	13,0	10,8	19,8	19,8	23,9	29,9	29,9	50,3	50,3	50,3	67,1	67,1	67,1
Cracked concrete																		
Tension	HST4	N_{Rd}	[kN]	3,8	5,2	5,7	4,1	11,3	11,3	6,7	14,7	14,7	12,0	18,0	25,3	23,3	23,3	23,3
Shear	HST4	V_{Rd}	[kN]	7,7	13,0	13,0	8,1	19,8	19,8	16,8	29,9	29,9	41,7	50,3	50,3	67,1	67,1	67,1

Recommended loads (Diamond-cored holes only for HST4)

Anchor size			M8			M10			M12			M16			M20			
Effective anchorage depth	h_{ef}	[mm]	30 ¹⁾	47	90	30 ¹⁾	60	100	40	70	125	65	85	160	101	120	180	
Uncracked concrete																		
Tension	HST4	N_{rec}	[kN]	¹⁾	5,9	6,3	¹⁾	10,9	14,3	5,9	13,7	14,3	12,3	18,4	21,9	23,8	23,8	23,8
Shear	HST4	V_{rec}	[kN]	¹⁾	9,3	9,3	¹⁾	14,2	14,2	17,1	21,4	21,4	35,9	35,9	35,9	47,9	47,9	47,9
Cracked concrete																		
Tension	HST4	N_{rec}	[kN]	¹⁾	3,7	4,1	¹⁾	8,1	8,1	4,8	10,5	10,5	8,6	12,9	18,1	16,7	16,7	16,7
Shear	HST4	V_{rec}	[kN]	¹⁾	9,3	9,3	¹⁾	14,2	14,2	12,0	21,4	21,4	29,8	35,9	35,9	47,9	47,9	47,9

¹⁾ Please refer "Requirements for redundant fastening" section

Requirements for redundant fastening

The definition of redundant fastening is given in EN 1992-4 and CEN/TR 17079. In Absence of a definition by a Member State the following parameters must be considered.

Minimum number of fixing points	Minimum number of anchors per fixing point	Maximum design load of action F_{sd} per fixing point
3	1	2 kN
4	1	3 kN

The value for maximum design load of actions per fastening point F_{sd} is valid in general that means all fastening points are considered in the design of the redundant structural system. F_{sd} can be a tension, shear or inclined load.

Seismic loading based on ETA-21/0878. Design according to EN 1992-4

All data in this section applies to:

- Correct setting (See setting instruction)
- For a single anchor
- Concrete C20/25, with or without Steel fibers (SFRC) (applicable for category C1 only)
- No edge distance and spacing influence (see table with characteristic distances)
- Characteristic spacing and edge distance for splitting failure apply only for uncracked concrete.
- For cracked concrete only the characteristic spacing and edge distance for concrete cone failure are decisive
- Minimum base material thickness (see table)
- Data given below are for 50 Years Working Life
- Embedment depth, as specified in the table of this section
- Anchor material, as specified in the tables of this section
- Hammer drilled, hammer drilled holes with Hilti hollow drill bit (M10-M20) and diamond cored holes (only for HST4-R)
- $\alpha_{gap} = 1,0$ (using Hilti filling set) and $\alpha_{gap} = 0,5$ (without using Hilti filling set) accordingly

For specific design cases refer to [PROFIS Engineering](#).

Design resistance in case of seismic performance C2

Anchor size		M8		M10		M12			M16			M20		
Effective anchorage depth	h_{ef} [mm]	47	90	60	100	40	70	125	65	85	160	101	120	180
with and without Hilti filling set														
Tension	$\frac{HST4}{HST4-R}$ $N_{Rd,C2}$ [kN]	2,9	3,1	8,3	8,3	5,6	13,2	14,4	11,8	17,7	25,5	19,8	23,3	23,3
		3,0	3,3	8,4	8,5	5,7	13,2	14,7	11,8	17,7	24,5	19,8	23,3	23,3
with Hilti filling set ($\alpha_{gap} = 1,0$)														
Shear	$\frac{HST4}{HST4-R}$ $V_{Rd,C2}$ [kN]	8,6	8,6	14,2	14,2	14,3	21,2	21,2	31,1	35,9	35,9	63,4	67,4	67,4
		8,2	8,2	14,9	15,0	14,3	19,2	19,2	35,5	41,0	41,0	53,9	53,9	53,9
without Hilti filling set ($\alpha_{gap} = 0,5$)														
Shear	$\frac{HST4}{HST4-R}$ $V_{Rd,C2}$ [kN]	4,3	4,3	7,1	7,1	7,1	10,6	10,6	15,6	18,0	18,0	26,8	26,8	26,8
		4,1	4,1	7,5	7,5	7,1	9,6	9,6	17,7	20,5	20,5	19,8	19,8	19,8

Design resistance in case of seismic performance C1

Anchor size		M8		M10		M12			M16			M20		
Effective anchorage depth	h_{ef} [mm]	47	90	60	100	40	70	125	65	85	160	101	120	180
with and without Hilti filling set														
Tension	$\frac{HST4}{HST4-R}$ $N_{Rd,C1}$ [kN]	6,3	7,5	10,5	12,1	5,7	13,2	17,5	11,8	17,7	24,7	19,8	23,3	23,3
		6,2	6,2	10,5	12,7	5,7	13,2	17,5	11,8	17,7	24,7	19,8	23,3	23,3
with Hilti filling set ($\alpha_{gap} = 1,0$)														
Shear	$\frac{HST4}{HST4-R}$ $V_{Rd,C1}$ [kN]	10,7	10,7	17,6	17,6	14,3	26,5	26,5	33,2	40,1	40,1	63,4	80,3	80,3
		12,6	12,6	18,6	18,6	14,3	31,9	31,9	35,5	48,6	48,6	63,4	82,1	82,2
without Hilti filling set ($\alpha_{gap} = 0,5$)														
Shear	$\frac{HST4}{HST4-R}$ $V_{Rd,C1}$ [kN]	5,4	5,4	8,8	8,8	7,1	13,3	13,3	16,6	20,0	20,1	31,0	31,0	31,0
		6,3	6,3	9,3	9,3	7,1	16,0	16,0	17,7	24,3	24,3	22,7	22,7	22,7

Fire resistance based on ETA-21/0878. Design according to EN 1992-4

All data in this section applies to:

- Correct setting (See setting instruction)
- For a single anchor
- Concrete C20/25, with and without steel fibers (SFRC)
- No edge distance and spacing influence (see table with characteristic distances)
- Characteristic spacing and edge distance for splitting failure apply only for uncracked concrete.
- For cracked concrete only the characteristic spacing and edge distance for concrete cone failure are decisive
- Minimum base material thickness (see table)
- Data given below are for 50 Years Working Life
- Embedment depth, as specified in the table of this section
- Anchor material, as specified in the tables of this section
- Hammer drilled, hammer drilled holes with Hilti hollow drill bit (M10-M20) and diamond cored holes
- Partial safety factor for resistance under fire exposure $\gamma_{M,fi} = 1,0$

Note: Embedment depths $h_{ef} < 40$ mm are applicable only for fastening of redundant non-structural systems as addressed in EN 1992-4, Clause 7.3 and CEN/TR 17079. For other types of fastenings please increase the embedment depth.

For specific design cases refer to [PROFIS Engineering](#).

Design resistance in case of fire

Anchor size			M8			M10			M12			M16			M20		
Effective anchorage depth	h_{ef}	[mm]	30 ¹⁾	47	90	30	60	100	40	70	125	65	85	160	101	120	180
Fire Exposure R30																	
Tension	$\frac{HST4}{HST4-R}$	$N_{Rd,fi(30)}$ [kN]	0,8	0,9	0,9	1,0	2,4	2,4	2,0	5,2	5,2	4,4	9,5	9,5	9,1	9,1	9,1
			0,8	2,5	2,5	1,0	5,0	5,0	2,0	7,0	7,0	6,8	9,5	9,5	9,1	9,1	9,1
Shear	$\frac{HST4}{HST4-R}$	$V_{Rd,fi(30)}$ [kN]	0,9	0,9	0,9	1,5	2,4	2,4	2,3	5,2	5,2	4,4	9,7	9,7	15,2	15,2	15,2
			1,7	4,9	4,9	1,8	11,1	11,8	5,0	17,1	17,1	16,9	31,9	31,9	49,8	49,8	49,8
Fire Exposure R60																	
Tension	$\frac{HST4}{HST4-R}$	$N_{Rd,fi(60)}$ [kN]	0,8	0,8	0,8	1,0	1,8	1,8	1,7	3,7	3,7	3,2	6,8	6,8	9,1	9,1	9,1
			0,8	2,5	2,5	1,0	5,0	5,0	2,0	7,0	7,0	6,8	9,5	9,5	9,1	9,1	9,1
Shear	$\frac{HST4}{HST4-R}$	$V_{Rd,fi(60)}$ [kN]	0,8	0,8	0,8	1,2	1,8	1,8	1,7	3,7	3,7	3,2	6,8	6,8	10,6	10,6	10,6
			1,7	3,6	3,6	1,8	8,4	8,4	4,4	12,2	12,2	12,6	22,8	22,8	35,5	35,5	35,5
Fire Exposure R90																	
Tension	$\frac{HST4}{HST4-R}$	$N_{Rk,fi(90)}$ [kN]	0,7	0,7	0,7	0,9	1,2	1,2	1,1	2,1	2,1	2,1	3,9	3,9	6,0	6,0	6,0
			0,8	2,4	2,4	1,0	5,0	5,0	2,0	7,0	7,0	6,8	9,5	9,5	9,1	9,1	9,1
Shear	$\frac{HST4}{HST4-R}$	$V_{Rk,fi(90)}$ [kN]	0,7	0,7	0,7	0,9	1,2	1,2	1,1	2,1	2,1	2,1	3,9	3,9	6,0	6,0	6,0
			1,4	2,4	2,4	1,8	5,0	5,0	3,6	7,3	7,3	8,4	13,6	13,6	21,2	21,2	21,2
Fire Exposure R120																	
Tension	$\frac{HST4}{HST4-R}$	$N_{Rd,fi(120)}$ [kN]	0,6	0,6	0,6	0,8	0,9	0,9	0,8	1,3	1,3	1,5	2,4	2,4	3,8	3,8	3,8
			0,7	1,7	1,7	0,8	3,3	3,3	1,6	4,8	4,8	5,4	7,6	7,6	7,3	7,3	7,3
Shear	$\frac{HST4}{HST4-R}$	$V_{Rd,fi(120)}$ [kN]	0,6	0,6	0,6	0,8	0,9	0,9	0,8	1,3	1,3	1,3	2,4	2,4	3,8	3,8	3,8
			1,2	1,7	1,7	1,5	3,3	3,3	3,2	4,8	4,8	6,2	9,0	9,0	14,1	14,1	14,1

¹⁾ Please refer "Requirements for redundant fastening" section

Setting information

Setting details

Anchor size		M8			M10			M12			M16			M20			
Nominal diameter of drill bit	d_o [mm]	8			10			12			16			20			
Maximum diameter of clearance hole in the fixture	d_f [mm]	9			12			14			18			22			
Torque moment	T_{inst} [Nm]	20			40			60			120			180			
Effective anchorage depth	h_{ef} [mm]	30	47	90	30	60	100	40	70	125	65	85	160	101	120	180	
Nominal embedment depth	h_{nom} [mm]	36	53	96	38	68	108	49	79	134	77	97	172	116	135	195	
		$h_{ef} + 6$			$h_{ef} + 8$			$h_{ef} + 9$			$h_{ef} + 12$			$h_{ef} + 15$			
Drill hole depth																	
Hammer drill	not cleaned	h_{1min} [mm]	56	73	116	58	88	128	69	99	154	97	117	192	136	155	215
			$h_{nom} + 20$														
	cleaned	h_{1min} [mm]	39	56	99	42	72	112	53	83	138	83	103	178	124	143	203
			$h_{nom} + 3$			$h_{nom} + 4$			$h_{nom} + 6$			$h_{nom} + 8$					
Hollow drill	h_{1min} [mm]	-	42	72	112	53	83	138	83	103	178	124	143	203			
		-	$h_{nom} + 4$			$h_{nom} + 6$			$h_{nom} + 8$								
Diamond coring	h_{1min} [mm]	46	63	106	48	78	118	59	89	144	87	107	182	126	145	205	
		$h_{nom} + 10$															
Concrete thickness below bore hole	h_{bmin} [mm]	21			27			32			34			36			
Minimum concrete thickness	h_{min} [mm]	$\max(80; 1,5 h_{ef}; h_1+h_b)$			$\max(80; 1,5 h_{ef}; h_1+h_b)$			$\max(100; 1,5 h_{ef}; h_1+h_b)$			$\max(120; 1,5 h_{ef}; h_1+h_b)$			$160 + h_{ef} - h_{ef-min}$			
Fixture thicknesses																	
Thickness of Hilti filling set	h_{fs} [mm]	8			9			10			11			13			
Effective fixture thickness with Hilti filling set	$t_{fix,ef}$ [mm]	$t_{fix} - h_{fs}$															
Characteristic distances HST4-R																	
Spacing for splitting failure and concrete cone failure ^{a)}	$S_{cr,sp}$ [mm]	122	200	143	173	304	218	199	306	224	381	515	368	384	456	684	
	$S_{cr,N}$ [mm]	90	141	270	90	180	300	120	210	375	195	255	480	303	360	540	
Edge distance for splitting failure and concrete cone failure ^{a)}	$C_{cr,sp}$ [mm]	61	100	72	86	152	109	99	153	112	190	258	184	192	228	342	
	$C_{cr,N}$ [mm]	45	71	135	45	90	150	60	105	188	98	128	240	152	180	270	
Characteristic distances HST4																	
Spacing for splitting failure and concrete cone failure ^{a)}	$S_{cr,sp}$ [mm]	114	176	126	140	210	166	168	244	186	246	336	250	384	456	684	
	$S_{cr,N}$ [mm]	90	141	270	90	180	300	120	210	375	195	255	480	303	360	540	
Edge distance for splitting failure and concrete cone failure ^{a)}	$C_{cr,sp}$ [mm]	57	88	63	70	105	83	84	122	93	123	168	125	192	228	342	
	$C_{cr,N}$ [mm]	45	71	135	45	90	150	60	105	188	98	128	240	152	180	270	

a) Values calculated under the hypothesis of uncracked concrete C20/25, cleaned, hammer drilled borehole. More details please refer ETA-21/0878, for specific design cases refer to [PROFIS Engineering](#).

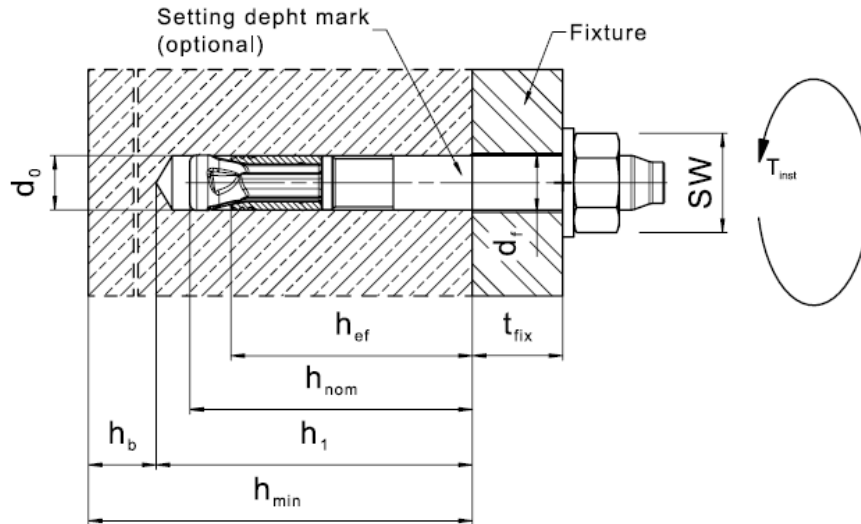

Minimum spacing s_{min} , edge distance c_{min} and required splitting area $A_{sp,req}$

We recommend checking your designs in Hilti's PROFIS Engineering software to verify the edge & spacing values. ETA-21/0878 provides formulae for the calculation of flexible edge & spacing for each anchor layout configuration depending on base material thickness.

Minimum spacing and edge distance values on the tables below are recommendations for specific anchor layout and base material dimensions.

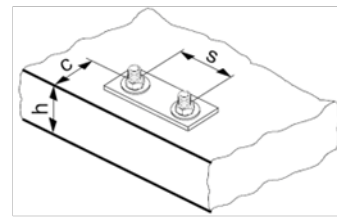
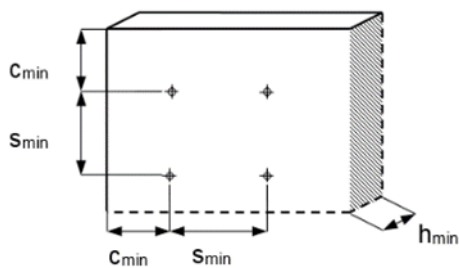

Anchor size HST4, HST4-R		M8					
Effective anchorage depth	h_{ef} [mm]	30		47		90	
Drill hole cleaned		yes	no	yes	no	yes	no
Min. base material thickness	h_{min} [mm]	80	80	80	100	135	140
Uncracked concrete							
Minimum spacing	s_{min} [mm]	35	35	35	35	35	35
	for c_{min} [mm]	70	70	70	55	45	45
Minimum edge distance	c_{min} [mm]	40	40	40	40	40	40
	for s_{min} [mm]	120	120	120	70	65	55
Cracked concrete							
Minimum spacing	s_{min} [mm]	35	35	35	35	35	35
	for c_{min} [mm]	50	50	50	50	40	40
Minimum edge distance	c_{min} [mm]	40	40	40	40	40	40
	for s_{min} [mm]	55	55	55	35	35	35

Anchor size HST4, HST4-R			M10					
Effective anchorage depth	h_{ef}	[mm]	30		60		100	
Drill hole cleaned			yes	no	yes	no	yes	no
Min. base material thickness	h_{min}	[mm]	80	90	100	115	150	155
Uncracked concrete								
Minimum spacing	s_{min}	[mm]	40	40	40	40	40	40
	for c_{min}	[mm]	100	90	80	70	55	55
Minimum edge distance	c_{min}	[mm]	45	45	45	45	45	45
	for s_{min}	[mm]	205	170	140	105	100	90
Cracked concrete								
Minimum spacing	s_{min}	[mm]	40	40	40	40	40	40
	for c_{min}	[mm]	80	70	65	55	50	50
Minimum edge distance	c_{min}	[mm]	45	45	45	45	45	45
	for s_{min}	[mm]	145	115	90	60	55	50

Anchor size HST4, HST4-R			M12					
Effective anchorage depth	h_{ef}	[mm]	40		70		125	
Drill hole cleaned			yes	no	yes	no	yes	no
Min. base material thickness	h_{min}	[mm]	100	105	115	135	190	190
Uncracked concrete								
Minimum spacing	s_{min}	[mm]	50	50	50	50	50	50
	for c_{min}	[mm]	125	120	105	90	70	70
Minimum edge distance	c_{min}	[mm]	55	55	55	55	55	55
	for s_{min}	[mm]	255	235	200	145	120	120
Cracked concrete								
Minimum spacing	s_{min}	[mm]	50	50	50	50	50	50
	for c_{min}	[mm]	95	90	80	65	60	60
Minimum edge distance	c_{min}	[mm]	55	55	55	55	55	55
	for s_{min}	[mm]	160	145	120	75	55	55









Anchor size HST4-R			M16					
Effective anchorage depth	h_{ef}	[mm]	65		85		160	
Drill hole cleaned			yes	no	yes	no	yes	no
Min. base material thickness	h_{min}	[mm]	120	135	140	155	240	240
Uncracked concrete								
Minimum spacing	s_{min}	[mm]	65	65	65	65	65	65
	for c_{min}	[mm]	115	100	95	85	70	70
Minimum edge distance	c_{min}	[mm]	65	65	65	65	65	65
	for s_{min}	[mm]	210	165	150	120	80	80
Cracked concrete								
Minimum spacing	s_{min}	[mm]	65	65	65	65	65	65
	for c_{min}	[mm]	100	85	80	70	65	65
Minimum edge distance	c_{min}	[mm]	65	65	65	65	65	65
	for s_{min}	[mm]	160	120	110	80	65	65

Anchor size HST4			M16					
Effective anchorage depth	h_{ef}	[mm]	65		85		160	
Drill hole cleaned			yes	no	yes	no	yes	no
Min. base material thickness	h_{min}	[mm]	120	135	140	155	240	240
Uncracked concrete								
Minimum spacing	s_{min}	[mm]	65	65	65	65	65	65
	for c_{min}	[mm]	140	125	120	105	80	80
Minimum edge distance	c_{min}	[mm]	65	65	65	65	65	65
	for s_{min}	[mm]	290	235	220	180	135	135
Cracked concrete								
Minimum spacing	s_{min}	[mm]	65	65	65	65	65	65
	for c_{min}	[mm]	105	90	85	75	65	65
Minimum edge distance	c_{min}	[mm]	65	65	65	65	65	65
	for s_{min}	[mm]	175	135	125	95	65	65

Anchor size HST4 , HST4-R			M20					
Effective anchorage depth	h_{ef}	[mm]	101		120		180	
Drill hole cleaned			yes	no	yes	no	yes	no
Min. base material thickness	h_{min}	[mm]	160	175	180	195	270	270
Uncracked concrete								
Minimum spacing	s_{min}	[mm]	90	90	90	90	90	90
	for c_{min}	[mm]	140	125	120	110	90	90
Minimum edge distance	c_{min}	[mm]	80	80	80	80	80	80
	for s_{min}	[mm]	260	220	205	170	140	140
Cracked concrete								
Minimum spacing	s_{min}	[mm]	90	90	90	90	90	90
	for c_{min}	[mm]	100	90	85	80	80	80
Minimum edge distance	c_{min}	[mm]	80	80	80	80	80	80
	for s_{min}	[mm]	145	110	100	90	90	90

Drilling and Installation equipment

For detailed setting information on installation see instructions (IFU) for use given with the product.

Rotary Hammers (Corded and Cordless)		TE 2 - TE 70
Diamond Coring Machines		DD EC-1, DD 30-W, DD 150-U
Other tools		Torque Impact wrench with AT module - SIW 6AT-22 & SI-AT-22 - SIW 4AT-22 & SI-AT-22
		Hammer drill bit TE-CX, TE-YX, TE-C, TE-Y
		Hollow drill bit TE-CD, TE-YD
		Diamond core bit TS, TL, SPX-T, SPX-L
		Setting Tool HS-SC
		Blow out pump



PRODUCT TECHNICAL DATASHEET

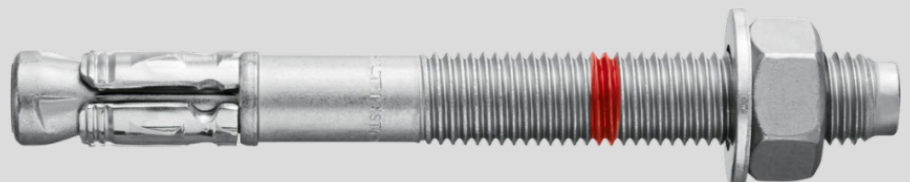

HST4(-R) Expansion anchor low strength concrete

Steel-to-concrete







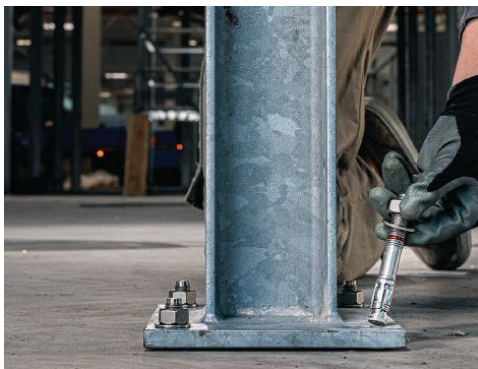

HST4 (-R) Wedge expansion anchor for low strength concrete (C12/15)

High-performance expansion anchor

Anchor version		Benefits
	<p>HST4(-R) (M8-M20)</p>	<ul style="list-style-type: none"> - High capacity anchor with ability to be used in reduced member thickness, small spacing and edge distances - Suitable for cracked and uncracked concrete C12/15 to C90/105 - Longer embedment depth options to gain higher resistance, closer distance to the edge or smaller spacing
	<p>HST4(-R) DN (M10-M12)</p>	<ul style="list-style-type: none"> - Full design flexibility with variable embedment depth and edge & spacing - Faster and reliable installation thanks to approved non-cleaning and adaptive torquing tool
	<p>HST4(-R) BW (M8 - M16)</p>	<ul style="list-style-type: none"> - Dome-nut variant available for more aesthetic application finish - Product length identification mark facilitates quality control and inspection



Base material		Load conditions	
 <p>Concrete (uncracked)</p>	 <p>Concrete (cracked)</p>	 <p>Static/ quasi-static</p>	
Drilling, cleaning, setting		Other information	
 <p>Hammer drilled holes (with no cleaning)</p>	 <p>Impact wrench with adaptive torque module</p>	 <p>PROFIS Engineering software</p>	 <p>Steel to concrete Handbook</p>



Linked Approvals/Certificates and Instructions for use

Approvals/certificates

Approval no	Application / loading condition	Authority / Laboratory	Date of issue
ETA-21/0878	Static and quasi-static	CSTB, Marne-la-Vallée	09-10-2025

Static and quasi-static loading based on ETA-21/0878. Design according to EN 1992-4

All data in this section applies to:

- Correct setting (see setting instruction)
- Single anchor
- Concrete C12/15
- No edge distance and spacing influence (see table with characteristic distances)
- Characteristic spacing and edge distance for splitting failure only applies for uncracked concrete.
- Data given below are for 50 Years Working Life
- For cracked concrete only the characteristic spacing and edge distance for concrete cone failure are decisive
- Minimum base material thickness (see setting detail table)
- Embedment depth, as specified in the table of this section
- Anchor material, as specified in the tables of this section
- Recommended loads: With overall partial safety factor for action $\gamma = 1,4$.

Note: Embedment depths $h_{ef} < 40$ mm are applicable only for fastening of redundant non-structural systems as addressed in EN 1992-4, Clause 7.3 and CEN/TR 17079. For other types of fastenings please increase the embedment depth.

For specific design cases refer to [PROFIS Engineering](#).

Design resistance

Anchor size		M8			M10			M12			M16			M20
Effective anchorage depth	h_{ef} [mm]	30 ¹⁾	47	90	30 ¹⁾	60	100	40	70	125	65	85	160	101
Uncracked concrete														
Tension	$\frac{HST4}{HST4-R}$ N_{Rd} [kN]	4,2	7,1	7,1	4,2	9,7	9,7	6,4	14,3	14,3	13,3	18,6	18,6	23,0
		4,2	7,1	7,1	4,2	9,7	9,7	6,4	14,3	14,3	13,3	18,6	18,6	23,0
Shear	$\frac{HST4}{HST4-R}$ V_{Rd} [kN]	4,2	8,2	11,1	4,2	14,7	14,7	6,4	27,2	27,9	26,6	39,8	42,0	51,5
		4,2	8,2	11,1	4,2	14,7	14,7	6,4	27,2	27,9	26,6	39,8	42,0	51,5
Cracked concrete														
Tension	$\frac{HST4}{HST4-R}$ N_{Rd} [kN]	2,9	5,1	5,1	2,9	8,3	8,5	4,5	10,4	13,3	9,3	13,9	19,1	-
		2,9	5,1	5,1	2,9	8,3	8,5	4,5	10,4	13,3	9,3	13,9	19,1	-
Shear	$\frac{HST4}{HST4-R}$ V_{Rd} [kN]	2,9	5,7	11,1	2,9	14,7	14,7	4,5	20,8	27,9	18,6	27,9	42,0	-
		2,9	5,7	11,1	2,9	14,7	14,7	4,5	20,8	27,9	18,6	27,9	42,0	-

Recommended loads

Anchor size		M8			M10			M12			M16			M20
Effective anchorage depth	h_{ef} [mm]	30 ¹⁾	47	90	30 ¹⁾	60	100	40	70	125	65	85	160	101
Uncracked concrete														
Tension	$\frac{HST4}{HST4-R}$ N_{rec} [kN]	¹⁾	5,1	5,1	¹⁾	7,0	7,0	4,6	10,2	10,2	9,5	13,3	13,3	16,4
		¹⁾	5,1	5,1	¹⁾	9,7	9,7	6,4	14,3	14,3	13,3	18,6	18,6	16,4
Shear	$\frac{HST4}{HST4-R}$ V_{rec} [kN]	¹⁾	5,8	7,9	¹⁾	10,5	10,5	4,6	19,4	19,9	19,0	28,4	30,0	36,8
		¹⁾	5,8	7,9	¹⁾	14,7	14,7	6,4	27,2	27,9	26,6	39,8	42,0	36,8
Cracked concrete														
Tension	$\frac{HST4}{HST4-R}$ N_{rec} [kN]	¹⁾	3,7	3,7	¹⁾	5,9	6,1	3,2	7,4	9,5	6,7	10,0	13,7	-
		¹⁾	3,7	3,7	¹⁾	5,9	6,1	3,2	7,4	9,5	6,7	10,0	13,7	-
Shear	$\frac{HST4}{HST4-R}$ V_{rec} [kN]	¹⁾	4,1	7,9	¹⁾	10,5	10,5	3,2	14,8	19,9	13,3	19,9	30,0	-
		¹⁾	4,1	7,9	¹⁾	10,5	10,5	3,2	14,8	19,9	13,3	19,9	30,0	-

¹⁾ Please refer "Requirements for redundant fastening" section which mentioned in the HST4 Standard PDS

Setting information

Setting details

Anchor size		M8			M10			M12			M16			M20			
Nominal diameter of drill bit	d_o [mm]	8			10			12			16			20			
Maximum diameter of clearance hole in the fixture	d_f [mm]	9			12			14			18			22			
Torque moment	T_{inst} [Nm]	20			40			60			120			180			
Effective anchorage depth	h_{ef} [mm]	30	47	90	30	60	100	40	70	125	65	85	160	101	120	180	
Nominal embedment depth	h_{nom} [mm]	36	53	96	38	68	108	49	79	134	77	97	172	116	135	195	
		$h_{ef} + 6$			$h_{ef} + 8$			$h_{ef} + 9$			$h_{ef} + 12$			$h_{ef} + 15$			
Drill hole depth																	
Hammer drill	not cleaned	h_{1min} [mm]	56	73	116	58	88	128	69	99	154	97	117	192	136	155	215
	cleaned	h_{1min} [mm]	$h_{nom} + 20$														
			39	56	99	42	72	112	53	83	138	83	103	178	124	143	203
			$h_{nom} + 3$			$h_{nom} + 4$			$h_{nom} + 6$			$h_{nom} + 8$					
Hollow drill	h_{1min} [mm]	-	42	72	112	53	83	138	83	103	178	124	143	203			
		-	$h_{nom} + 4$			$h_{nom} + 6$			$h_{nom} + 8$								
Diamond coring	h_{1min} [mm]	46	63	106	48	78	118	59	89	144	87	107	182	126	145	205	
		$h_{nom} + 10$															
Concrete thickness below bore hole	h_{bmin} [mm]	21			27			32			34			36			
Minimum concrete thickness	h_{min} [mm]	max(80; 1,5 h_{ef} ; h_1+h_b)			max(80; 1,5 h_{ef} ; h_1+h_b)			max(100; 1,5 h_{ef} ; h_1+h_b)			max(120; 1,5 h_{ef} ; h_1+h_b)			160 + h_{ef} - h_{ef-min}			
Fixture thicknesses																	
Thickness of Hilti filling set	h_{fs} [mm]	8			9			10			11			13			
Effective fixture thickness with Hilti filling set	$t_{fix,ef}$ [mm]	$t_{fix} - h_{fs}$															
Characteristic distances HST4-R																	
Spacing for splitting failure and concrete cone failure ^{a)}	$s_{cr,sp}$ [mm]	195	315	193	166	411	278	176	490	309	183	237	140	384	-	-	
	$s_{cr,N}$ [mm]	90	141	270	90	180	300	120	210	375	195	255	480	303	-	-	
Edge distance for splitting failure and concrete cone failure ^{a)}	$c_{cr,sp}$ [mm]	98	157	96	83	206	139	88	245	155	91	119	70	192	-	-	
	$c_{cr,N}$ [mm]	45	71	135	45	90	150	60	105	188	98	128	240	152	-	-	
Characteristic distances HST4																	
Spacing for splitting failure and concrete cone failure ^{a)}	$s_{cr,sp}$ [mm]	195	315	193	166	411	278	176	490	309	183	237	140	404	-	-	
	$s_{cr,N}$ [mm]	90	141	270	90	180	300	120	210	375	195	255	480	303	-	-	
Edge distance for splitting failure and concrete cone failure ^{a)}	$c_{cr,sp}$ [mm]	98	157	96	83	206	139	88	245	155	91	119	70	202	-	-	
	$c_{cr,N}$ [mm]	45	71	135	45	90	150	60	105	188	98	128	240	152	-	-	

Please refer ETA-21/0878 for Minimum spacing s_{min} , edge distance c_{min} and required splitting area $A_{sp,req}$.
For specific design cases refer to [PROFIS Engineering](#).