

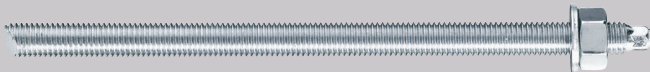

# ANCHOR FASTENING

Technology Manual  
February 2020

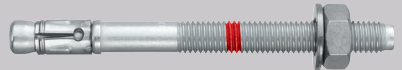

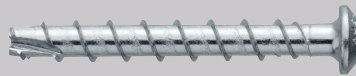



## Important notices

1. The technical data presented in this Anchor Fastening Technology Manual is based on numerous tests and evaluation criteria according to the current state-of-the-art and the relevant European regulations.
2. For all those anchors holding a European Technical Assessment (ETA), noted in the cover with the respective icon, the technical data given in this manual is based and in accordance with the information given in the respective ETA. Additional Hilti technical data, supplementing the ETA technical data, may be available, in which case, it will be clearly noted on footnotes and/or tables.
3. For all those anchors not holding an ETA, the technical data given in this manual is based on numerous tests and evaluation criteria according to the current state-of-the-art and/or the relevant European applicable regulations for the assessment of fasteners, which is the basis for obtaining an ETA.
4. In addition to the tests for standard service conditions (including, in some cases, seismic as an option), fire resistance, shock and fatigue tests may have been performed – see respective reports for full details.
5. The data and values are based on the respective average values obtained from tests under laboratory or other controlled conditions, or on generally-accepted methodology. It is the responsibility of the customer to use the data given in the light of conditions on site and taking into account the intended use of the products concerned. The customer must check the listed prerequisites and criteria conform with the conditions actually existing on the job-site. Whilst Hilti can give general guidance and advice, the nature of Hilti products means that the ultimate responsibility for selecting the right product for a particular application must lie with the customer.
6. The given technical data in the Anchor Fastening Technology Manual is valid only for the indicated test conditions. Due to variations in local base materials, on-site testing maybe required to determine performance at any specific jobsite.
7. Technical data presented herein was current as of the date of publication (see back cover). Hilti's policy is one of continuous development. We therefore reserve the right to alter technical data and specifications, etc. without notice.
8. Construction materials and conditions vary on different sites. If it is suspected that the base material has insufficient strength to achieve a suitable fastening, contact the Technical Competence Center of your local Hilti organization.
9. All products must be used, handled and applied strictly in accordance with all current instructions for use published by Hilti, i.e. technical instructions, operating manuals, setting instructions, installation manuals and others.
10. All products are supplied and advice is given subject to the local Hilti organization terms of business.
11. While reasonable measures have been taken to provide accurate information, no warranty is provided that it is without error. Hilti shall in no event be obligated for direct, indirect, incidental, consequential, or any other damages, losses or expenses in connection with, or by reason of, the use of, or inability to use, the products or information for any purpose. Implied warranties of merchantability and fitness for a particular purpose are specially excluded.

Hilti Corporation  
FL-9494 Schaan  
Principality of Liechtenstein  
[www.hilti.group](http://www.hilti.group)

Hilti = registred trademark of the Hilti Corporation, Schaan

## Table Of Contents

Anchor selector	4
Design of fastenings in concrete: Eurocode 2 Part 4 (EN 1992-4)	14
Resistance under fire exposure	16
Selection of corrosion protection for anchors	22
<b>Chemical Anchors</b>	
<b>Concrete</b>	
HIT-RE 500 V3	24
HIT-HY 200-A/R	64
HIT-HY 200-R V3	104
HIT-RE 100	134
HIT-RE 100-HC	162
HIT-HY 110	192
HIT-HY 100	212
HIT-CT 1	234
HIT-ICE	258
HVZ	272
HVU2	278
<b>Multimaterial</b>	
HIT-HY 170	294
HIT-MM Plus	334
HIT-1 / HIT-1 CE	348
<b>Masonry</b>	
HIT-HY 270	360
<b>Mechanical Anchors</b>	
<b>Undercut Anchor</b>	
HDA	390
HMU-PF	400
HSC	406
<b>Expansion Anchor</b>	
HSL-3(-R)	416
HST3	430
HST2	440
HSA	450
HSV	458
HSB	462
<b>Screw Anchor</b>	
HUS3	466
HUS-HR / HUS-CR	500
HUS2-H	508
HUS 6 / HUS-S 6	516

<b>Flush Anchor</b>	
HKD	522
HKV	536
<b>Plastic Anchors</b>	
HRD	540
HRV	560
HPS-1	566
HUD-1	570
HUD-L	576
HLD	580
HMF	584
GD 14 + GRS 12	588
<b>Light Duty Metal Anchor</b>	
HFB	592
DBZ	600
HK	604
HLC	610
HT	616
HLV	620
HAM	624
HPD	626
HKH	630
HCA	634
HHD-S	638
HSP / HFP	640
HA 8 NG	642
HTB	646
<b>Insulation Anchor</b>	
HIF	650
HTH	654
HTR-P / HTR-M	666
T-Save HTS-P / HTS-M	672
IDP	678



## Chemical anchor selector

Anchor type		Concrete													
		Hilti HIT-RE 500 V3			Hilti HIT-HY 200-A/R				Hilti HIT-HY 200-R V3			Hilti HIT-RE 100		Hilti HIT-RE 100-HC	
Anchor size		M8-M39	M8-M20	φ8-φ40	M8-M30	M8-M20	M8-M20	φ8-φ32	M8-M30	M8-M20	φ8-φ32	M8-M30	φ8-φ40	M8-M30	φ8-φ40
Base material	Cracked concrete	■	■	■	■	■	■	■	■	■	■	■	■	■	■
	Uncracked concrete	■	■	■	■	■	■	■	■	■	■	■	■	■	■
	Lightweight concrete														
	Aerated concrete														
	Solid brick masonry														
	Hollow brick masonry														
	Drywall														
Approvals	European Technical approval (ETA)	■	■	■	■	■	■	■	■	■	■	■	■	■	■
	ETA seismic C1	■	■	■	■	■	■	■	■	■	■				
	ETA seismic C2	■			■	■			■						
	Fatigue approval*	■													
	Shock approval*	■	■	■											
	Fire tested	■	■		■	■	■	■	■	■	■				
SafeSet		■	■		■	■	■		■	■					
Clean-Tec															
Specification	Steel, galvanized	■			■	■	■		■	■		■		■	
	Steel, hot dip galvanized				■				■						
	Stainless steel A2														
	Stainless steel A4	■	■		■	■			■			■		■	
	HCR steel	■			■				■			■		■	
	Rebar B500 B			■				■			■		■		■
	External thread	■			■	■			■			■		■	
	Internal thread	■	■		■	■	■		■	■		■		■	
Setting	Pre-setting	■	■		■	■	■		■	■		■		■	
	Through-fastening					■									
Profis		■	■	■	■	■	■	■	■	■	■				

\*Local approvals

■ ETA approval only for anchoring in concrete with rebar elements









□ ETA approval only for post-installed rebar applications (according to EC2)

Concrete

Hilti HIT-HY 110			Hilti HIT-HY 100			Hilti HIT-CT 1		Hilti HIT-ICE			HVZ	HVU2	
M8-M30	M8-M20	φ8-φ25	M8-M30	M8-M20	φ8-φ25	M8-M24	φ8-φ25	M8-M24	M8-M20	φ8-φ25	M10-M20	M8-M30	M8-M20
■	■	■	■	■	■	■	■	■	■	■	■	■	■
■	■	■	■	■	■	■	■	■	■	■	■	■	■
■	■	▣	■	■	▣	■	■				■	■	■
												■	
											■	■	
											■	■	■
											■	■	■
■	■		■	■		■		■	■		■	■	■
■								■					
■	■		■	■		■		■	■		■	■	■
■			■			■		■			■	■	
■	■		■	■		■		■	■		■	■	■
											■		
						■	■	■	■	■	■	■	■



## Chemical anchor selector

Anchor type		Multimaterial							Masonry		
		Hilti HIT-HY 170			Hilti HIT-MM Plus			Hilti HIT-1	Hilti HIT-HY 270		
											
Anchor size		M8-M24	M8-M16	M8-M12	φ8-φ25	M8-M24	M8-M12	M6-M12	M8-M16	M6-M16	M8-M12
Base material	Cracked concrete	■			□						
	Uncracked concrete	■	■		□	■	■		■		
	Lightweight concrete										
	Aerated concrete										
	Solid brick masonry			■		■	■	■	■	■	■
	Hollow brick masonry			■		■	■	■	■	■	■
	Drywall										
Approvals	European Technical approval (ETA)	■	■	■	□				■	■	■
	ETA seismic C1	■									
	ETA seismic C2	■									
	Fatigue approval*										
	Shock approval*										
	Fire tested										
SafeSet											
Clean-Tec											
Specification	Steel, galvanized	■	■	■		■	■	■	■	■	■
	Steel, hot dip galvanized								■		
	Stainless steel A2										
	Stainless steel A4	■	■			■			■	■	
	HCR steel	■								■	
	Rebar B500 B				■						
	External thread	■				■				■	
	Internal thread	■	■	■		■	■			■	■
Setting	Pre-setting	■	■	■		■	■	■	■	■	■
	Through-fastening								■		
Profis		■	■								

\*Local approvals







■ ETA approval only for anchoring in concrete with rebar elements

□ ETA approval only for post-installed rebar applications (according to EC2)





## Mechanical anchor selector







Anchor type		Undercut anchors			Expansion anchors			
		HDA	HMU-PF	HSC	HSL-3	HST3	HST2	HSA
								
Anchor size		M10-M20	M8-M20	M6-M12	M8-M24	M8-M24	M8-M16	M6-M20
Base material	Cracked concrete	■	■	■	■	■	■	
	Non-cracked	■	■	■	■	■	■	■
	Lightweight concrete							
	Aerated concrete							
	Solid brick masonry							
	Hollow brick							
	Drywall							
Redundant fastening								
Approvals	European Technical approval (ETA)	■	■	■	■	■	■	■
	ETA seismic C1	■	■		■	■		
	ETA seismic C2	■			■	■		
	Fatigue approval*	■			■			
	Shock approval*	■		■	■	■		
	Fire tested	■	■	■	■	■	■	■
Specification	Steel, galvanized	■	■	■	■	■	■	■
	Steel, hot dip galvanized	■	■					■
	Stainless steel A2							■
	Stainless steel A4	■		■	■	■	■	■
	HCR steel							
	External thread	■	■	■	■	■	■	■
	Internal thread			■				
Setting	Pre-setting	■	■	■	■	■	■	■
	Through-fastening	■			■	■	■	■
Profis		■	■	■	■	■	■	■

\*Local approvals



Expansion anchors		Screw anchors					Flush anchors		
HSV	HSB	HUS3	HUS3 REDUNDANT	HUS-HR HUS-CR	HUS2-H	HUS 6 HUS-S 6	HKD	HKD REDUNDANT	HKV
M8-M16	M8-M16	6-14	6	6-14	8-10	6	M6-M20	M6-M16	M6-M16
		■	■		■	■		■	
■	■	■	■	■	■	■	■	■	■
		■	■	■		■			
		■	■	■		■			
						■			
			■			■		■	
	■	■	■	■	■		■	■	
		■		■					
		■		■					
■	■	■	■	■	■	■	■	■	■
		■							
			■	■			■	■	
		■	■						
■		■	■			■	■	■	■
■	■						■	■	■
	■	■	■	■	■	■			
		■		■			■		

## Mechanical anchor selector

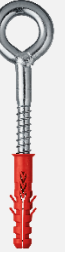
Anchor type		Plastic anchors							
		HRD	HRV	HPS-1	HUD-1	HUD-L	HLD	HMF	GD14+GRS
									
Anchor size (drill bit diameter)		M8-M10	M10	M4-M8	M5-M14	M6-M10	M10	M5-M14	M14
Base material	Cracked concrete	■							
	Non-cracked	■	■	■	■	■	■		■
	Lightweight concrete	■	◻	◻	■	■			
	Aerated concrete	■	◻	■	■	■		■	
	Solid brick masonry	■	■	■	■	■	■	■	■
	Hollow brick	■	◻	■	■	■	■	■	
	Drywall				■	■	◻	■	
Redundant fastening									
Approvals	European Technical approval (ETA)	◻							
	ETA seismic C1								
	ETA seismic C2								
	Fatigue approval*								
	Shock approval*								
	Fire tested	■							
Specification	Steel, galvanized	■	■	■				■	
	Steel, hot dip galvanized	■	■						
	Stainless steel A2	■		■					
	Stainless steel A4								
	HCR steel								
	External thread								
	Internal thread								
Setting	Pre-setting				■	■	■		
	Through-fastening	■	■	■	■	■		■	
Profis									

■ May be suitable for specific applications





◻ ETA approval only for redundant fastening applications

\*Local approvals

Light duty metal anchors

HFB	DBZ	HK	HLC	HT	HLV	HAM	HPD	HKH	HCA	HHD-S	HSP/HFP	HA8 NG	HTB
M6	M6	M8-M30	M5-M16	M8-M10	M5-M12	M6-M12	M6-M10	M6-M10	M16	M4-M8	M4,5	M8	M5-M6
■	■								■			■	
■	■	■	■	■	■	■							
				■			■	■					
			■	■		■							■
				■									■
										■	■		■
	■												
■	□	□											
■*													
■*													
■	■	■	■	■			■	■					
	■	■	■	■	■	■	■	■	■	■	■	■	
■		■					■	■					
■		■											
		■	■		■		■	■					
		■				■				■			
■		■	■		■	■	■	■		■	■		■
■	■		■	■	■			■				■	

## Mechanical anchor selector

Anchor type		Insulation anchors				
		HIF	HTH	HTR-P(M)	HTS-P(M)	IDP
						
Anchor size		8	8	8	8	8
Base material	Cracked concrete			■		
	Non-cracked	■	■	■	■	■
	Lightweight concrete		■	■	■	
	Aerated concrete	■	■	■	■	
	Solid brick masonry	■	■	■	■	■
	Hollow brick	■	■	■	■	■
	Drywall					
Approvals	European Technical approval (ETA)		■	■	■	
	ETA seismic C1					
	ETA seismic C2					
	Fatigue approval*					
	Shock approval*					
	Fire tested					
Specification	Steel, galvanized		■			
	Steel, hot dip galvanized					
	Stainless steel A2					
	Stainless steel A4					
	HCR steel					
	External thread					
	Internal thread					
Setting	Pre-setting					
	Through-fastening	■	■	■	■	■
Profis						





## Design of fastenings in concrete: Eurocode 2 Part 4 (EN 1992-4)

A new anchor design standard to improve efficiency, consistency and safety in construction is available now. What are the differences and similarities between Eurocode 2 Part 4 and ETAG 001?

Guidelines are used as a temporary solution in the absence of an official standard for a specific application or product. Standards supersede relevant guidelines and technical reports when they are officially published. Whereas standards are mandatory documents to be complied with, guidelines are treated more like a recommendation. However, they both have similar purposes, which is helping to avoid:

- Anchor failures that may lead to partial or total collapse of structures
- Possible casualties and economic loss due to improper anchor design

On the other hand, they also have certain differences:

<b>ETAG 001</b>	<b>EUROCODE 2 PART 4 (EN 1992-4)</b>
Is a guideline and recommendation on how to design post-installed anchors.	Is a legitimate document when designing anchor channels, cast-in anchors and post installed fastenings.
Is only available in English.	Will have local language versions in each CEN accredited country.
Has limited updates.	Will be supported with national annexes published by local governmental entities.
Creates limited awareness as a non-mandatory document.	Creates high awareness for cracked concrete usage as an international standard.
No definition for specification details and proper anchor selection on the jobsite.	Defines how to specify anchors and which steps to follow on the jobsite enabling proper anchor selection and installation.
Has no information about creep behavior of bonded fasteners under sustained loading.	Has concise information regarding how to design bonded fasteners under sustained loading.

Hilti has already implemented Eurocode 2's new section for the design of concrete fastenings (Part 4) into our PROFIS Engineering software together with the updated ETAs (European Technical Approvals), allowing engineers to design according to the new standard and making fastening design easier and safer.

For more information you can reach out to your local Hilti Engineering Team.





## Resistance under fire exposure

### Testing conditions

Tested in cracked concrete and exposed to flames from one side without insulating or protective measures.

In case of fire attack from more than one side, the minimum edge distance shall be  $\geq 300$  mm.

In case of wet concrete  $h_{ef}+30$ mm

### ISO Curve

The ISO curve (ISO 834), also called the standard fire temperature curve, is the thermal stress generally applied in component analyses/tests in the building industry.



### ZTV-ING Curve

The ZTV-ING curve applies to road tunnels in Germany regardless of their design and the type of traffic.





### Testing institutions



MFPA Leipzig Warrington MPA Braunschweig iBMB Braunschweig DIBt

## Chemical Anchors

Anchor	Size	$h_{ef}$ [mm]	Characteristic tensions resistance $N_{Rk,s,fi}$ [ kN ]				Authority / No.
			R30	R60	R90	R120	
<b>Anchors below tested in accordance to ISO 834 fire curve</b>							
<b>HIT-RE 500 V3 + HIT-V-5.8, HIT-V-8.8</b>  	<b>Cracked Concrete</b>						Original Test Report: MFPA_GS-3.2/15-361-4  *For different embedment depths $h_{ef}$ please see the full report  Data valid for <b>steel</b> failure
	M8	80*	0,79	0,62	0,00	0,00	
	M10	90*	1,43	1,13	0,32	0,00	
	M12	95*	2,33	1,77	0,40	0,00	
	M16	110*	4,35	3,31	1,23	0,00	
	M20	130*	6,75	5,25	3,29	1,28	
	M24	155*	9,75	7,58	5,40	3,96	
	M27	175*	12,8	9,90	7,05	5,63	
M30	195*	15,5	12,0	8,63	6,90		
<b>HIT-RE 500 V3 + HIT-V-R</b>  	<b>Cracked Concrete</b>						
	M8	80*	2,37	1,16	0,35	0,00	
	M10	90*	4,50	2,00	0,85	0,11	
	M12	95*	5,43	2,63	1,14	0,23	
	M16	110*	11,6	4,88	2,63	1,13	
	M20	130*	20,9	8,85	5,61	3,36	
	M24	155*	30,0	14,8	9,45	5,48	
	M27	175*	39,1	25,7	12,3	7,13	
M30	195*	47,8	31,4	15,0	8,70		



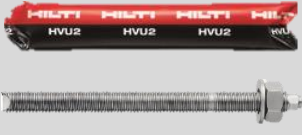













Anchor	Size	h <sub>ef</sub> [mm]	Characteristic tensions resistance N <sub>Rk,s,fi</sub> [ kN ]				Authority / No.
			R30	R60	R90	R120	
<b>Anchors below tested in accordance to ISO 834 fire curve</b>							
<b>HIT-HY 200-A + HIT-V 5.8</b> 	<b>Cracked Concrete</b>						Original Test Report: IBMB 3501/676/12  *For different embedment depths h <sub>ef</sub> please see the full report  Data valid for <u>steel</u> failure
	M8	80*	1,20	0,45	0,24	0,17	
	M10	90*	2,00	0,75	0,40	0,28	
	M12	95*	3,00	0,96	0,50	0,36	
	M16	110*	6,18	1,76	0,92	0,63	
	M20	130*	9,70	3,50	1,80	1,18	
	M24	155*	14,0	8,00	4,00	2,53	
	M27	175*	18,3	12,5	6,20	3,90	
	M30	195*	22,3	17,9	10,7	6,60	
<b>HIT-HY 200-A + HIT-V 8.8 HIT-Z</b> 	<b>Cracked Concrete</b>						
	M8	80*	1,64	0,45	0,24	0,17	
	M10	90*	2,75	0,75	0,40	0,28	
	M12	95*	3,40	0,96	0,50	0,36	
	M16	110*	6,20	1,76	0,92	0,63	
	M20	130*	12,6	3,51	1,79	1,18	
	M24	155*	23,6	8,00	4,00	2,53	
	M27	175*	30,9	16,67	8,30	5,19	
	M30	195*	37,6	21,7	10,7	6,60	
<b>HIT-HY 200-A + HIT-V-R, HIT-Z-R</b> 	<b>Cracked Concrete</b>						
	M8	80*	1,64	0,45	0,24	0,17	
	M10	90*	2,75	0,75	0,40	0,28	
	M12	95*	3,43	0,96	0,50	0,36	
	M16	110*	6,18	1,76	0,92	0,63	
	M20	130*	12,6	3,50	1,80	1,18	
	M24	155*	29,7	8,00	4,00	2,53	
	M27	175*	30,9	16,7	8,30	5,20	
	M30	195*	71,9	21,7	10,7	6,60	
<b>HVU2 + HAS 5.8</b> 	<b>Cracked concrete</b>						Original Test Report: 16056MR15542 TU Kaiserslautern  *For different threaded rods please see the full report  Data valid for <u>steel</u> failure
	M8	80	0,00	0,00	0,00	0,00	
	M10	90	2,90	1,75	0,73	0,35	
	M12	110	4,22	3,20	1,87	0,99	
	M16	125	7,85	5,55	2,98	1,66	
	M20	170	12,2	9,30	6,37	4,40	
	M24	210	17,6	13,4	9,18	6,35	
	M27	240	22,9	17,4	11,9	8,26	
	M30	270	28,0	21,3	14,6	10,1	





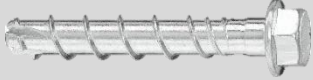

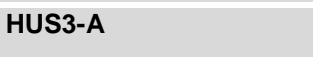
Anchor	Size	h <sub>ef</sub> [mm]	Characteristic tensions resistance N <sub>Rk,s,fi</sub> [ kN ]				Authority / No.
			R30	R60	R90	R120	
<b>Anchors below tested in accordance to ISO 834 fire curve</b>							
<b>HVU2 + HAS-R</b> 	<b>Cracked Concrete</b>						Original Test Report: 16056MR15542 TU Kaiserslautern  *For different threaded rods please see the full report  Data valid for <b>steel</b> failure
	M8	80	0,00	0,00	0,00	0,00	
	M10	90	4,98	1,75	0,73	0,35	
	M12	110	8,97	3,66	1,87	0,99	
	M16	125	12,8	5,55	2,98	1,66	
	M20	170	28,0	16,2	10,1	6,89	
	M24	210	40,4	28,3	16,3	10,2	
	M27	240	52,5	36,8	21,1	13,3	
M30	270	64,2	45,0	25,8	16,3		
<b>Anchors below tested in accordance to ZTV-ING fire curve</b>							
<b>HIT-HY 200-A + HCR steel</b> 	<b>Cracked Concrete</b>						Original Test Report: GS 3.2/15-364-2  Please notice that the data is not for any failure modes <sup>1)</sup> .
	M8	≥ 80			0,40		
	M10	≥ 90			0,70		
	M12	≥ 110			1,25		
	M16	≥ 125			3,50		
M20	≥ 170			4,00			
<b>HVU2 + HAS-E-HCR</b> 	<b>Cracked Concrete</b>						Original Test Report: GU-21804  Please notice that the data is not for any failure modes <sup>1)</sup> .
	M8	80			1,10		
	M10	90			1,50		
	M12	110			2,75		
	M16	125			4,00		
	M20	170			6,50		
M24	210			8,50			

<sup>1)</sup> The ZTV-ING curve is not tested until failure. Instead, it is tested for a fire duration of 30 minutes at 1200 °C, followed by a 110 minute long cooling down phase.

## Mechanical Anchors

Anchor	Size	h <sub>ef</sub> [mm]	Characteristic tensions resistance N <sub>Rk,s,fi</sub> [ kN ]				Authority / No.
			R30	R60	R90	R120	
<b>Anchors below tested in accordance to ISO 834 fire curve</b>							
<b>HDA</b> 	<b>Cracked Concrete</b>						Original Test Report: IBMB Braunschweig UB 3039/8151  Warringtonfire WF Report no 364181  Data valid for <b>steel</b> failure.
	<b>M10</b>	100	4,50	2,20	1,30	1,00	
	<b>M12</b>	125	10,0	3,50	1,80	1,20	
	<b>M16</b>	190	15,0	7,00	4,00	3,00	
	<b>M20</b>	250	25,0	9,00	7,00	5,00	
<b>HDA-F</b> 	<b>Cracked Concrete</b>						
	<b>M10</b>	100	4,50	2,20	1,30	1,00	
	<b>M12</b>	125	10,0	3,50	1,80	1,20	
	<b>M16</b>	190	15,0	7,00	4,00	3,00	
<b>HDA-R</b> 	<b>Cracked Concrete</b>						
	<b>M10</b>	100	20,0	9,00	4,00	2,00	
	<b>M12</b>	125	30,0	12,0	5,00	3,00	
	<b>M16</b>	190	50,0	15,0	7,50	6,00	
<b>HMU-PF</b> 	<b>Cracked Concrete</b>						Original Test Report: ETA-14/0069 Data valid for <b>steel</b> failure.
	<b>M12</b>	80	1,70	1,30	1,10	0,80	
	<b>M16</b>	100	3,10	2,40	2,00	1,60	
	<b>M16</b>	125	3,10	2,40	2,00	1,60	
<b>HSC-A</b> 	<b>Cracked Concrete</b>						Original Test Report: IBMB Braunschweig UB 3177/1722-1  Warringtonfire WF Report no 364181
	<b>M8</b>	40-50	-	-	1,50	-	
	<b>M10</b>	40	-	-	1,50	-	
	<b>M12</b>	60	-	3,50	2,00	-	
<b>HSC-AR</b> 	<b>Cracked Concrete</b>						
	<b>M8</b>	40-50	-	-	1,50	-	
	<b>M10</b>	40	-	-	1,50	-	
	<b>M12</b>	60	-	-	3,50	3,00	
<b>HSC-I</b> 	<b>Cracked Concrete</b>						
	<b>M8</b>	40-50	-	-	1,50	-	
	<b>M10</b>	40	-	-	2,50	-	
	<b>M12</b>	60	-	-	2,00	-	
<b>HSC-IR</b> 	<b>Cracked Concrete</b>						
	<b>M8</b>	40-50	-	-	1,50	-	
	<b>M10</b>	40	-	-	2,50	-	
	<b>M12</b>	60	-	-	3,50	3,0	
<b>HST-HCR</b> 	<b>Cracked Concrete</b>						Original Test Report: ETA-98/001  Warringtonfire WF Report no 364181
	<b>M8</b>	-	1,30	2,30	2,70	1,0	
	<b>M10</b>	-	2,30	2,30	2,30	1,8	
	<b>M12</b>	-	3,00	3,00	3,00	2,4	
	<b>M16</b>	-	6,30	6,30	6,30	5,00	

Anchor	Size	h <sub>ef</sub> [mm]	Characteristic tensions resistance N <sub>Rk,s,fi</sub> [ kN ]				Authority / No.	
			R30	R60	R90	R120		
<b>HST3</b> 	<b>Cracked Concrete</b>						Original Test Report: ETA-98/001  Warringtonfire WF Report no 364181	
	M8	47	0,90	0,80	0,70	0,60		
	M10	40	1,50	1,20	0,90	0,80		
	M10	60	2,40	1,80	1,20	0,90		
	M12	50	2,30	1,70	1,10	0,80		
	M12	70	5,00	3,70	2,10	1,30		
	M16	65	4,40	3,20	2,10	1,50		
	M16	85	7,10	6,80	3,90	2,40		
	M20	101	9,10	9,10	6,00	3,80		
M24	125	12,6	12,6	8,70	5,40			
<b>HST3-R</b> 	<b>Cracked Concrete</b>							
	M8	47	1,90	1,90	1,90	1,50		
	M10	40	2,30	2,30	2,30	1,80		
	M10	60	3,00	3,00	3,00	2,40		
	M12	50	3,20	3,20	3,20	2,50		
	M12	70	5,00	5,00	5,00	4,00		
	M16	65	4,70	4,70	4,70	3,80		
	M16	85	7,10	7,10	7,10	5,60		
	M20	101	9,10	9,10	9,10	7,30		
M24	125	12,6	12,6	12,6	10,1			
<b>HUS3-H</b> 	<b>Cracked Concrete</b>						Original Test Report: ETA-13/1038  Warringtonfire WF Report no 364181  Data valid for <u>steel</u> failure.	
	M6	55	1,50	1,20	0,80	0,70		
	M8	50	1,50	1,50	1,50	1,2		
	M8	60	2,30	2,30	1,60	1,20		
	<b>HUS3-HF</b> 	M8	70	3,00	2,80	1,90		1,50
		M10	55	2,00	2,00	2,00		1,60
		M10	75	4,00	4,00	3,20		2,50
		M10	85	4,90	4,70	3,20		2,50
		M14	65	3,10	3,10	3,10		2,50
M14	85	4,80	4,80	4,80	3,80			
M14	115	7,80	7,80	5,50	4,30			
<b>HUS3-C</b> 	<b>Cracked Concrete</b>							
	M6	55	1,50	1,20	0,80	0,70		
	M8	50	0,50	0,40	0,30	0,20		
<b>HUS3-A</b> 	M10	55	1,20	1,00	0,80	0,60		
	<b>Cracked Concrete</b>							
<b>HUS3-I</b> 	M6	55	1,50	1,20	0,80	0,70		
	M6	55	1,50	1,20	0,80	0,70		

Anchor	Size	h <sub>ef</sub> [mm]	Characteristic tensions resistance N <sub>Rk,s,fi</sub> [ kN ]				Authority / No.
			R30	R60	R90	R120	
<b>HUS3-I-Flex</b>	<b>Cracked Concrete</b>						Original Test Report: ETA-13/1038  Data valid for <b>steel</b> failure.
	M6	55	1,60	1,20	0,80	0,70	
<b>HUS3-P</b>	M6	55	1,60	1,20	0,80	0,70	
<b>HUS3-PS</b>	M6	55	1,60	1,20	0,80	0,70	
<b>HUS3-PL</b>	M6	55	1,60	1,20	0,80	0,70	
<b>HUS HR</b> 	<b>Cracked Concrete</b>						Original Test Report: ETA-08/0307  Data valid for <b>steel</b> failure.
	M6	55	1,30	1,30	1,30	1,00	
	M8	60	1,50	1,50	1,50	1,20	
	M8	80	3,00	3,00	3,00	1,70	
	M10	70	2,30	2,30	2,30	1,80	
	M10	90	4,00	4,00	4,00	2,40	
	M14	70	3,00	3,00	3,00	2,40	
	M14	110	6,30	6,30	6,30	5,00	
<b>HUS-CR</b> 	M6	55	0,20	0,20	0,20	0,10	
	M8	60	0,80	0,60	0,50	0,40	
	M8	80	0,80	0,60	0,50	0,40	
	M10	70	1,40	1,10	0,90	0,80	
	M10	90	1,40	1,10	0,90	0,80	
<b>HKD_redundant</b> 	<b>Cracked Concrete</b>						Original Test Report: ETA-06/0047  Warringtonfire WF Report no 364181
	M6	25	0,50	0,40	0,30	0,20	
	M8	25	0,60	0,60	0,60	0,50	
	M8	30	0,90	0,90	0,90	0,70	
<b>HKV</b> 	M8	40	1,30	1,30	1,30	0,7	
	M10	25	0,60	0,60	0,60	0,5	
	M10	30	0,90	0,90	0,90	0,7	
	M10	40	1,80	1,80	1,80	1,50	
<b>Anchors below tested in accordance to ZTV-ING fire curve</b>							
<b>HST3-R</b> 	<b>Cracked Concrete</b>						Original Test Report: GS 3.2/14-319-3  Please notice that the data is not for any failure modes <sup>1)</sup> .
	M8	≥ 47			0,60		
	M10	≥ 40			1,05		
	M12	≥ 50			1,75		
	M16	≥ 65			3,60		
	M20	≥ 117			4,50		
<b>HST-HCR</b> 	<b>Cracked Concrete</b>						Original Test Report: GS 2101/679/16 Please notice that the data is not for any failure modes <sup>1)</sup> .
	M8	-			≥ 1,00		
	M10	-			≥ 1,50		
	M12	-			≥ 2,00		
	M16	-			≥ 4,00		

<sup>1)</sup> The ZTV-ING curve is not tested until failure. Instead, it is tested for a fire duration of 30 minutes at 1200 °C, followed by a 110 minute long cooling down phase.

# Selection of corrosion protection for anchors



	Anchors	HSA HUS3 HST3 HIT-V	HUS3-HF	HSA-F HIT-V-F	HSA-R2	HUS3-HR HSA-R HST3-R HIT-V-R HIT-Z-R	HST3-HCR
	Coating/Material	Electro galvanize	Duplex coated carbon steel	HDG/sherardized 45-50 µm	A2 AISI 304	A4 AISI 316	HCR, e.g. 1.4529
Environmental Conditions	Fastened part						
Dry indoor	Steel (zinc-coated, painted), aluminum, stainless steel	■	■	■	■	■	■
Indoor with temporary condensation	Steel (zinc-coated, painted), aluminium	-	■	■	■	■	■
	Stainless steel	-	-	-	-	-	-
Outdoor with low pollution	Steel (zinc-coated, painted), aluminium	-	□ *	□ *	■ *	■	■
	Stainless steel	-	-	-	-	-	-
Outdoor with moderate concentration of pollutants	Steel (zinc-coated, painted), aluminium	-	□ *	□ *	■ *	■	■
	Stainless steel	-	-	-	-	-	-
Coastal areas	Steel (zinc-coated, painted), aluminum, stainless steel	-	-	-	-	■	■
Outdoor, areas with heavy industrial pollution	Steel (zinc-coated, painted), aluminum, stainless steel	-	-	-	-	■	■
Close proximity to roads treated with de-icing salts	Steel (zinc-coated, painted), aluminum, stainless steel	-	-	-	-	■	■
Special applications	-	Consult experts					■





- = expected lifetime of anchors made from this material is typically satisfactory in the specified environment based on the typically expected lifetime of a building. The assumed service life in ETA approvals for powder-actuated and screw fasteners is 25 years, and for concrete anchors it is 50 years.
- = a decrease in the expected lifetime of non-stainless fasteners in these atmospheres must be taken into account (≤ 25 years). Higher expected lifetime needs a specific assessment.
- = fasteners made from this material are not suitable in the specified environment. Exceptions need a specific assessment.



\* From a technical point of view, HDG/duplex coatings and A2/304 material are suitable for outdoor environments with certain lifetime and application restrictions. This is based on longterm experience with these materials as reflected e.g. in the corrosion rates for Zn given in the ISO 9224:2012 (corrosivity categories, C-classes), the selection table for stainless steel grades given in the national technical approval issued by the DIBt Z.30.3-6 (April 2009) or the ICC-ES evaluation reports for our KB-TZ anchors for North America (e.g. ESR-1917, May 2013). The use of those materials in outdoor environments however is currently not covered by the European Technical Approval (ETA) of anchors, where it is stated that anchors made of galvanized carbon steel or stainless steel grade A2 may only be used in structures subject to dry indoor conditions, based on an assumed working life of the anchor of 50 years.

## Environment categories

Applications can be classified into various environmental categories, by taking the following factors into account:

Indoor applications	
	<b>Dry indoor environments</b> (Heated or air-conditioning areas) without condensation, e.g. office buildings, schools.
	<b>Indoor environments with temporary condensation</b> (Unheated areas without pollutant) e.g. storage sheds

Outdoor applications	
	<b>Outdoor, rural or urban environment with low population</b> Large distance (> 10 km) from the sea
	<b>Outdoor, rural or urban environment with moderate concentration of pollutants and/or salt from sea water</b> Distance from the sea 1-10 km
	<b>Coastal areas</b> Distance from sea <1 km
	<b>Outdoor areas with heavy industrial pollution</b> Close to plants < 1 km (e.g. petrochemical, coal industry)
	<b>Close proximity to roadways threatened with de-icing salts</b> Distance to roadways < 10 m

Outdoor applications	
 	<b>Special applications</b> Areas with special corrosive conditions, e.g. road tunnels with de-icing salt, indoor swimming pools, special applications in the chemical industry (exceptions possible).

### Important notes

The ultimate decision on the required corrosion protection must be made by the customer. Hilti accepts no responsibility regarding the suitability of a product for a specific application, even if informed of the application conditions.

The tables are based on an average service life for typical applications.

For metallic coatings, e.g. zinc layer systems, the end of lifetime is the point at which red rust is visible over a large fraction of the product and widespread structural deterioration can occur – the initial onset of rust may occur sooner.

National or international codes, standards or regulations, customer and/or industry specific guidelines must be independently considered and evaluated.

These guidelines apply to atmospheric corrosion only. Special types of corrosion, such as crevice corrosion or hydrogen assisted cracking must be independently evaluated.

The tables published in this brochure describe only a general guideline for commonly accepted applications in typical atmospheric environments.

Suitability for a specific application can be significantly affected by localised conditions, including but not limited to:

Elevated temperatures and humidity; High levels of airborne pollutants; Direct contact with corrosive products, such as found in some types of chemically-treated wood, waste water, concrete additives, cleaning agents, etc. ;Direct contact to soil, stagnant water; Electrical current; Contact with dissimilar metals; Confined areas, e.g. crevices; Physical damage or wear; Extreme corrosion due to combined effects of different influencing factors; Enrichment of pollutants on the product



# HIT-RE 500 V3 injection mortar

Anchor design (EN 1992-4) / Rods&Sleeves / Concrete

## Injection mortar system



Foil pack: HIT-RE 500 V3  
(available in 330, 500 and 1400 ml cartridges)

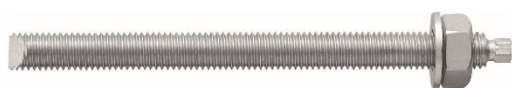

Anchor rod:  
HAS-U  
HAS-U HDG  
HAS-U A4  
HAS-U HCR  
AM 8.8 (HDG)  
(M8-M39)



Internally threaded sleeve:  
HIS-N  
HIS-RN  
(M8-M20)

## Benefits

- **SafeSet** technology: Simplified method of borehole preparation using either Hilti hollow drill bit for hammer drilling or Roughening tool for diamond cored applications
- Suitable for cracked/non-cracked concrete C 20/25 to C 50/60
- High loading capacity
- Suitable for dry and water saturated concrete
- Hilti Technical Data for under water application
- High corrosion resistance
- Long working time at elevated temperatures
- Cures down to -5°C
- Odourless epoxy

## Base material



Concrete (non-cracked)



Concrete (cracked)

## Installation conditions

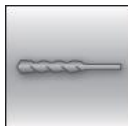

Hammer drilled holes



Diamond drilled holes



Hilti **SafeSet** technology



Small edge distance and spacing

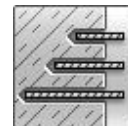

Variable embedment depth

## Load conditions



Static/  
quasi-static



Seismic,  
ETA-C1, C2



Fire  
resistance

## Other information



European  
Technical  
Assessment



CE conformity



PROFIS  
design  
Software

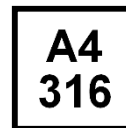

Corrosion  
resistance



High  
corrosion  
resistance <sup>a)</sup>

a) Applications only with HAS-U anchor rods

## Approvals / certificates

Description	Authority / Laboratory	No. / date of issue
European Technical Assessment <sup>a)</sup>	CSTB	ETA-16/0143 / 2019-05-14
Shockproof fastenings in civil defence installations	Federal Office for Civil Protection, Bern	BZS D 16-601/ 2016-08-31
Fire test report <sup>b)</sup>	MFPA Leipzig	GS 3.2/15-361-4 / 2016-08-04

a) All data given in this section according to ETA-16/0143, issue 2019-05-14.

b) Fire test report only available for HAS-U rods.



## Static and quasi-static resistance (for a single anchor)

### All data in this section applies to:

- Correct setting (See setting instruction)
- No edge distance and spacing influence
- **Steel** failure
- HAS-U anchor rod with strength class 5.8 and 8.8, AM anchor rod with strength class 8.8, HIS-N internally threaded insert with screw 8.8
- Base material thickness, as specified in the table
- One typical embedment depth as specified in the table
- Concrete C 20/25,  $f_{ck,cube} = 25 \text{ N/mm}^2$
- Temperature range I  
(min. base material temperature  $-40^\circ\text{C}$ , max. long/short term base material temperature:  $+24^\circ\text{C}/40^\circ\text{C}$ )

### Embedment depth <sup>a)</sup> and base material thickness

Anchor size	ETA-16/0143, issue 2019-05-14								Hilti technical data		
	M8	M10	M12	M16	M20	M24	M27	M30	M33	M36	M39
<b>HAS-U</b>											
Eff. anchorage depth [mm]	80	90	110	125	170	210	240	270	300	330	360
Base material thickness [mm]	110	120	140	161	214	266	300	340	374	410	444
<b>HIS-N</b>											
Eff. anchorage depth [mm]	90	110	125	170	205	-	-	-	-	-	-
Base material thickness [mm]	120	150	170	230	270	-	-	-	-	-	-

a) The allowed range of embedment depth is shown in the setting

### For hammer drilled holes, hollow drill bit<sup>1)</sup> and diamond cored with roughening tool<sup>2)</sup>:

#### Characteristic resistance

Anchor size	ETA-16/0143, issue 2019-05-14								Hilti technical data			
	M8	M10	M12	M16	M20	M24	M27	M30	M33	M36	M39	
<b>Non-cracked concrete</b>												
Tension $N_{Rk}$ [kN]	HAS-U 5.8	18,0	29,0	42,0	76,9	122	168	205	244	286	330	376
	HAS-U 8.8, AM	29,0	46,0	63,5	76,9	122	168	205	244	286	330	376
	HAS-U A4	26,0	41,0	59,0	76,9	122	168	205	244	286	330	376
	HAS-U HCR	29,0	46,0	63,5	76,9	122	168	205	244	286	330	376
	HIS-N 8.8	25,0	46,0	67,0	121,9	116	-	-	-	-	-	-
Shear $V_{Rk}$ [kN]	HAS-U 5.8	9,0	15,0	21,0	39,0	61,0	88,0	115	140	174	204	244
	HAS-U 8.8, AM	15,0	23,0	34,0	63,0	98,0	141	184	224	278	327	390
	HAS-U A4	13,0	20,0	30,0	55,0	86,0	124	115	140	174	204	244
	HAS-U HCR	15,0	23,0	34,0	63,0	98,0	124	161	196	174	204	244
	HIS-N 8.8	13,0	23,0	34,0	63,0	58,0	-	-	-	-	-	-
<b>Cracked concrete</b>												
Tension $N_{Rk}$ [kN]	HAS-U 5.8	15,1	22,6	39,4	53,8	85,3	117	143	171	-	-	-
	HAS-U 8.8, AM	15,1	22,6	39,4	53,8	85,3	117	143	171	-	-	-
	HAS-U A4	15,1	22,6	39,4	53,8	85,3	117	143	171	-	-	-
	HAS-U HCR	15,1	22,6	39,4	53,8	85,3	117	143	171	-	-	-
	HIS-N 8.8	25,0	44,4	53,8	85,3	113	-	-	-	-	-	-
Shear $V_{Rk}$ [kN]	HAS-U 5.8	9,0	15,0	21,0	39,0	61,0	88,0	115	140	-	-	-
	HAS-U 8.8, AM	15,0	23,0	34,0	63,0	98,0	141	184	224	-	-	-
	HAS-U A4	13,0	20,0	30,0	55,0	86,0	124	115	140	-	-	-
	HAS-U HCR	15,0	23,0	34,0	63,0	98,0	124	161	196	-	-	-
	HIS-N 8.8	13,0	23,0	34,0	63,0	58,0	-	-	-	-	-	-

1) Hilti hollow drill bit available for element size M12-M30.

2) Roughening tools are available for element size M16-M30.

**Design resistance**

Anchor size		ETA-16/0143, issue 2019-05-14								Hilti tech. data		
		M8	M10	M12	M16	M20	M24	M27	M30	M33	M36	M39
<b>Non-cracked concrete</b>												
Tension $N_{Rd}$	HAS-U 5.8	12,0	19,3	28,0	45,8	72,7	99,8	122	146	142	164	187
	HAS-U 8.8, AM 8.8	19,3	28,0	37,8	45,8	72,7	99,8	122	146	142	164	187
	HAS-U A4 [kN]	13,9	21,9	31,6	45,8	72,7	99,8	80,4	98,3	121	143	171
	HAS-U HCR	19,3	28,0	37,8	45,8	72,7	99,8	122	146	142	164	187
	HIS-N 8.8	16,7	30,7	44,7	72,7	77,3	-	-	-	-	-	-
Shear $V_{Rd}$	HAS-U 5.8	7,2	12,0	16,8	31,2	48,8	70,4	92,0	112	139	163	195
	HAS-U 8.8, AM 8.8	12,0	18,4	27,2	50,4	78,4	113	147	179	222	262	312
	HAS-U A4 [kN]	8,3	12,8	19,2	35,3	55,1	79,5	48,3	58,8	73,1	85,7	103
	HAS-U HCR	12,0	18,4	27,2	50,4	78,4	70,9	92,0	112	87,0	102	122
	HIS-N 8.8	10,4	18,4	27,2	50,4	46,4	-	-	-	-	-	-
<b>Cracked concrete</b>												
Tension $N_{Rd}$	HAS-U 5.8	10,1	15,1	26,3	32,1	50,9	69,9	85,4	102	-	-	-
	HAS-U 8.8, AM 8.8	10,1	15,1	26,3	32,1	50,9	69,9	85,4	102	-	-	-
	HAS-U A4 [kN]	10,1	15,1	26,3	32,1	50,9	69,9	80,4	98,3	-	-	-
	HAS-U HCR	10,1	15,1	26,3	32,1	50,9	69,9	85,4	102	-	-	-
	HIS-N 8.8	16,7	26,5	32,1	50,9	67,4	-	-	-	-	-	-
Shear $V_{Rd}$	HAS-U 5.8	7,2	12,0	16,8	31,2	48,8	70,4	92,0	112	-	-	-
	HAS-U 8.8, AM 8.8	12,0	18,4	27,2	50,4	78,4	113	147	179	-	-	-
	HAS-U A4 [kN]	8,3	12,8	19,2	35,3	55,1	79,5	48,3	58,8	-	-	-
	HAS-U HCR	12,0	18,4	27,2	50,4	78,4	70,9	92,0	112	-	-	-
	HIS-N 8.8	10,4	18,4	27,2	50,4	46,4	-	-	-	-	-	-

- 1) Hilti hollow drill bit available for element size M12-M30.  
 2) Roughening tools are available for element size M16-M30.

**Recommended loads <sup>a)</sup>**

Anchor size		ETA-16/0143, issue 2019-05-14								Hilti technical data		
		M8	M10	M12	M16	M20	M24	M27	M30	M33	M36	M39
<b>Non-cracked concrete</b>												
Tension $N_{Rec}$	HAS-U 5.8	8,6	13,8	20,0	32,7	51,9	71,3	87,1	104	101	117	133
	HAS-U 8.8, AM	13,8	20,0	27,0	32,7	51,9	71,3	87,1	104	101	117	133
	HAS-U A4	9,9	15,7	22,5	32,7	51,9	71,3	57,4	70,2	86,7	102	122
	HAS-U HCR	13,8	20,0	27,0	32,7	51,9	71,3	87,1	104	101	117	133
	HIS-N 8.8	11,9	21,9	31,9	51,9	55,2	-	-	-	-	-	-
Shear $V_{Rec}$	HAS-U 5.8	5,1	8,6	12,0	22,3	34,9	50,3	65,7	80,0	99,4	117	139
	HAS-U 8.8, AM	8,6	13,1	19,4	36,0	56,0	80,6	105	128	159	187	223
	HAS-U A4	6,0	9,2	13,7	25,2	39,4	56,8	34,5	42,0	52,2	61,2	73,2
	HAS-U HCR	8,6	13,1	19,4	36,0	56,0	50,6	65,7	80,0	62,1	72,9	87,1
	HIS-N 8.8	7,4	13,1	19,4	36,0	33,1	-	-	-	-	-	-
<b>Cracked concrete</b>												
Tension $N_{Rec}$	HAS-U 5.8	7,2	10,8	18,8	22,9	36,3	49,9	61,0	72,7	-	-	-
	HAS-U 8.8, AM	7,2	10,8	18,8	22,9	36,3	49,9	61,0	72,7	-	-	-
	HAS-U A4	7,2	10,8	18,8	22,9	36,3	49,9	57,4	70,2	-	-	-
	HAS-U HCR	7,2	10,8	18,8	22,9	36,3	49,9	61,0	72,7	-	-	-
	HIS-N 8.8	11,9	18,9	22,9	36,3	48,1	-	-	-	-	-	-
Shear $V_{Rec}$	HAS-U 5.8	5,1	8,6	12,0	22,3	34,9	50,3	65,7	80,0	-	-	-
	HAS-U 8.8, AM	8,6	13,1	19,4	36,0	56,0	80,6	105	128	-	-	-
	HAS-U A4	6,0	9,2	13,7	25,2	39,4	56,8	34,5	42,0	-	-	-
	HAS-U HCR	8,6	13,1	19,4	36,0	56,0	50,6	65,7	80,0	-	-	-
	HIS-N 8.8	7,4	13,1	19,4	36,0	33,1	-	-	-	-	-	-

a) With overall partial safety factor for action  $\gamma=1,4$ . The partial safety factors for action depend on the type of loading and shall be taken from national regulations.

**For diamond drilling:**
**Characteristic resistance**

Anchor size		M8	M10	M12	M16	M20	M24	M27	M30
<b>Non-cracked concrete</b>									
Tension $N_{Rk}$	HAS-U 5.8	18,0	29,0	42,0	76,9	122	167	205	244
	HIS-N 8.8	25,0	46,0	67,0	122	116	-	-	-
Shear $V_{Rk}$	HAS-U 5.8	9,0	15,0	21,0	39,0	61,0	88,0	115	140
	HIS-N 8.8	13,0	23,0	34,0	63,0	58,0	-	-	-

**Design resistance**

Anchor size		M8	M10	M12	M16	M20	M24	M27	M30
<b>Non-cracked concrete</b>									
Tension $N_{Rd}$	HAS-U 5.8	12,0	19,3	28,0	32,7	51,9	71,3	87,1	104
	HIS-N 8.8	16,7	24,4	32,7	51,9	68,8	-	-	-
Shear $V_{Rd}$	HAS-U 5.8	7,2	12,0	16,8	31,2	48,8	70,4	92,0	112
	HIS-N 8.8	10,4	18,4	27,2	50,4	46,4	-	-	-

### Recommended loads <sup>b)</sup>

Anchor size		M8	M10	M12	M16	M20	M24	M27	M30
<b>Non-cracked concrete</b>									
Tensile $N_{Rec}$	HAS-U 5.8	8,6	13,8	20,0	23,4	37,1	50,9	62,2	74,2
	HIS-N 8.8	11,9	17,5	23,4	37,1	49,1	-	-	-
Shear $V_{Rec}$	HAS-U 5.8	5,1	8,6	12,0	22,3	34,9	50,3	65,7	80,0
	HIS-N 8.8	7,4	13,1	19,4	36,0	33,1	-	-	-

a) With overall partial safety factor for action  $\gamma=1,4$ . The partial safety factors for action depend on the type of loading and shall be taken from national regulations.

### Seismic resistance

#### All data in this section applies to:

- Correct setting (See setting instruction)
- No edge distance and spacing influence
- Steel failure
- Anchor HAS-U strength class 8.8, anchor AM 8.8
- Base material thickness, as specified in the table
- One typical embedment depth as specified in the table
- Concrete C 20/25,  $f_{ck,cube} = 25 \text{ N/mm}^2$
- Temperature range I  
(min. base material temperature  $-40^\circ\text{C}$ , max. long/short term base material temperature:  $+24^\circ\text{C}/40^\circ\text{C}$ )
- $\alpha_{gap}=1,0$  (using Hilti seismic filling set)

#### Embedment depth and base material thickness for seismic C2 <sup>a)</sup> and C1

Anchor size		M8	M10	M12	M16	M20	M24	M27	M30
<b>HAS-U</b>									
Eff. Anchorage depth	[mm]	80	90	110	125	170	210	240	270
Base material thickness	[mm]	110	120	140	161	214	266	300	340
<b>HIS-N</b>									
Eff. Anchorage depth	[mm]	90	110	125	170	205	-	-	-
Base material thickness	[mm]	120	146	169	226	269	-	-	-

a) C2 seismic approval only available for HAS-U rods.

#### For hammer drilled holes, hollow drill bit and diamond cored with roughening tool:

#### Characteristic resistance in case of seismic performance category C2

Anchor size		M8	M10	M12	M16	M20	M24	M27	M30
Tensile $N_{Rk}$	HAS-U 8.8, AM 8.8 [kN]	-	-	-	37,1	57,7	80,8	102	132
Shear $V_{Rk}$	HAS-U 8.8, AM 8.8 w/ filling set	-	-	-	46,0	77,0	103	-	-
	HAS-U 8.8, AM 8.8 w/o filling set	-	-	-	40,0	71,0	90,0	121	135

#### Design resistance in case of seismic performance category C2

Anchor size		M8	M10	M12	M16	M20	M24	M27	M30
Tensile $N_{Rd}$	HAS-U 8.8, AM 8.8 [kN]	-	-	-	24,7	38,5	53,8	67,9	88,2
Shear $V_{Rd}$	HAS-U 8.8, AM 8.8 w/ filling set	-	-	-	36,8	61,6	82,4	-	-
	HAS-U 8.8, AM 8.8 w/o filling set	-	-	-	32,0	56,8	72,0	96,8	108

For hammer drilled holes and hammer drilled holes with Hilti hollow drill bit:

**Characteristic resistance in case of seismic performance category C1**

Anchor size		M8	M10	M12	M16	M20	M24	M27	M30
Tensile $N_{Rk}$	HAS-U 8.8, AM 8.8 [kN]	13,7	22,6	37,8	45,7	72,5	99,6	122	145
	HIS-N 8.8	25,0	37,8	45,7	72,5	96,1	-	-	-
Shear $V_{Rk}$	HAS-U 8.8, AM 8.8 [kN]	15,0	23,0	34,0	63,0	98,0	141	184	224
	HIS-N 8.8	9,0	16,0	24,0	44,0	41,0	-	-	-

**Design resistance in case of seismic performance category C1**

Anchor size		M8	M10	M12	M16	M20	M24	M27	M30
Tensile $N_{Rd}$	HAS-U 8.8, AM 8.8 [kN]	9,1	15,1	25,2	30,5	48,4	66,4	81,1	96,8
	HIS-N 8.8	16,7	25,2	30,5	48,4	64,0	-	-	-
Shear $V_{Rd}$	HAS-U 8.8, AM 8.8 [kN]	12,0	18,4	27,2	50,4	78,4	113	147	179
	HIS-N 8.8	7,2	12,8	19,2	35,2	32,8	-	-	-

**Materials**

**Mechanical properties for HAS-U**

Anchor size		ETA-16/0143, issue 2019-05-14								Hilti Technical data		
		M8	M10	M12	M16	M20	M24	M27	M30	M33	M36	M39
Nominal tensile strength $f_{uk}$	HAS-U 5.8(F)	500	500	500	500	500	500	500	500	500	500	500
	HAS-U 8.8(F)	800	800	800	800	800	800	800	800	800	800	800
	AM 8.8(HDG)	800	800	800	800	800	800	800	800	800	800	800
	HAS-U A4	700	700	700	700	700	700	500	500	500	500	500
	HAS-U HCR	800	800	800	800	800	700	700	700	500	500	500
Yield strength $f_{yk}$	HAS-U 5.8(F)	400	400	400	400	400	400	400	400	400	400	400
	HAS-U 8.8(F)	640	640	640	640	640	640	640	640	640	640	640
	AM 8.8(HDG)	640	640	640	640	640	640	640	640	640	640	640
	HAS-U A4	450	450	450	450	450	450	210	210	210	210	210
	HAS-U HCR	640	640	640	640	640	400	400	400	250	250	250
Stressed cross-section $A_s$	HAS-U AM 8.8 [mm <sup>2</sup> ]	36,6	58,0	84,3	157	245	353	459	561	694	817	976
Moment of resistance $W$	HAS-U AM 8.8 [mm <sup>3</sup> ]	31,2	62,3	109	277	541	935	1387	1874	2579	3294	4301

**Mechanical properties for HIS-N**

Anchor size		ETA-16/0143, issue 2019-05-14				
		M8	M10	M12	M16	M20
Nominal tensile strength $f_{uk}$	HIS-N	490	490	460	460	460
	Screw 8.8	800	800	800	800	800
	HIS-RN	700	700	700	700	700
	Screw A4-70	700	700	700	700	700
Yield strength $f_{yk}$	HIS-N	410	410	375	375	375
	Screw 8.8	640	640	640	640	640
	HIS-RN	350	350	350	350	350
	Screw A4-70	450	450	450	450	450
Stressed cross-section $A_s$	HIS-(R)N	51,5	108	169	256	238
	Screw	36,6	58	84,3	157	245
Moment of resistance $W$	HIS-(R)N	145	430	840	1595	1543
	Screw	31,2	62,3	109	277	541

### Material quality for HAS-U

Part	Material
<b>Zinc coated steel</b>	
Threaded rod, HAS-U 5.8 (HDG)	Strength class 5.8; Elongation at fracture A5 > 8% ductile Electroplated zinc coated $\geq 5\mu\text{m}$ ; (F) hot dip galvanized $\geq 45\mu\text{m}$
Threaded rod, HAS-U 8.8 (HDG)	Strength class 8.8; Elongation at fracture A5 > 12% ductile Electroplated zinc coated $\geq 5\mu\text{m}$ ; (F) hot dip galvanized $\geq 45\mu\text{m}$
Hilti Meter rod, AM 8.8 (HDG)	Strength class 8.8; Elongation at fracture A5 > 12% ductile Electroplated zinc coated $\geq 5\mu\text{m}$ (HDG) hot dip galvanized $\geq 45\mu\text{m}$
Washer	Electroplated zinc coated $\geq 5\mu\text{m}$ , hot dip galvanized $\geq 45\mu\text{m}$
Nut	Strength class of nut adapted to strength class of threaded rod. Electroplated zinc coated $\geq 5\mu\text{m}$ , hot dip galvanized $\geq 45\mu\text{m}$
<b>Stainless Steel</b>	
Threaded rod, HAS-U A4	Strength class 70 for $\leq M24$ and strength class 50 for $> M24$ ; Elongation at fracture A5 > 8% ductile Stainless steel 1.4401; 1.4404; 1.4578; 1.4571; 1.4439; 1.4362
Washer	Stainless steel 1.4401, 1.4404, 1.4578, 1.4571, 1.4439, 1.4362 EN 10088-1:2014
Nut	Stainless steel 1.4401, 1.4404, 1.4578, 1.4571, 1.4439, 1.4362 EN 10088-1:2014
<b>High corrosion resistant steel</b>	
Threaded rod, HAS-U HCR	Strength class 80 for $\leq M20$ and class 70 for $> M20$ , Elongation at fracture A5 > 8% ductile High corrosion resistance steel 1.4529; 1.4565;
Washer	High corrosion resistant steel 1.4529, 1.4565 EN 10088-1:2014
Nut	High corrosion resistant steel 1.4529, 1.4565 EN 10088-1:2014

### Material quality for HIS-N

Part	Material	
HIS-N	Internal threaded sleeve	C-steel 1.0718; Steel galvanized $\geq 5\mu\text{m}$
	Screw 8.8	Strength class 8.8, A5 > 8 % Ductile; Steel galvanized $\geq 5\mu\text{m}$
HIS-RN	Internal threaded sleeve	Stainless steel 1.4401, 1.4571
	Screw 70	Strength class 70, A5 > 8 % Ductile Stainless steel 1.4401; 1.4404, 1.4578; 1.4571; 1.4439; 1.4362

### Setting information

#### Installation temperature

-5°C to +40°C

#### Service temperature range

Hilti HIT-RE 500 V3 injection mortar may be applied in the temperature ranges given below. An elevated base material temperature may lead to a reduction of the design bond resistance.

Temperature range	Base material temperature	Max. long term base material temperature	Max. short term base material temperature
Temperature range I	-40 °C to +40 °C	+24 °C	+40 °C
Temperature range II	-40 °C to +70 °C	+43 °C	+70 °C

### Max short term base material temperature

Short-term elevated base material temperatures are those that occur over brief intervals, e.g. as a result of diurnal cycling.

### Max long term base material temperature

Long-term elevated base material temperatures are roughly constant over significant periods of time.

### Working time and curing time

Temperature of the base material T	Working time $t_{work}$	Minimum curing time $t_{cure}^{1)}$
-5 °C to -1 °C	2 h	168 h
0 °C to 4 °C	2 h	48 h
5 °C to 9 °C	2 h	24 h
10 °C to 14 °C	1,5 h	16 h
15 °C to 19 °C	1 h	12 h
20 °C to 24 °C	30 min	7 h
25 °C to 29 °C	20 min	6 h
30 °C to 34 °C	15 min	5 h
35 °C to 39 °C	12 min	4,5 h
40 °C	10 min	4 h

1) The curing time data are valid for dry base material only. In wet base material, the curing times must be doubled.

### Setting details for HAS-U

Anchor size	ETA-16/0143, issue 2019-05-14								Hilti Technical data			
	M8	M10	M12	M16	M20	M24	M27	M30	M33	M36	M39	
Nominal diameter of drill bit $d_0$ [mm]	10	12	14	18	22	28	30	35	37	40	42	
Effective anchorage and drill hole depth range <sup>a)</sup>	$h_{ef,min}$ [mm]	60	60	70	80	90	96	108	120	132	144	156
	$h_{ef,max}$ [mm]	160	200	240	320	400	480	540	600	660	720	780
Minimum base material thickness $h_{min}$ [mm]	$h_{ef} + 30 \text{ mm}$ $\geq 100 \text{ mm}$			$h_{ef} + 2 d_0$								
Max. torque moment $T_{max}$ [Nm]	10	20	40	80	150	200	270	300	330	360	390	
Minimum spacing $s_{min}$ [mm]	40	50	60	75	90	115	120	140	165	180	195	
Min. edge distance $c_{min}$ [mm]	40	45	45	50	55	60	75	80	165	180	195	
Critical spacing for splitting failure $s_{cr,sp}$ [mm]	$2 c_{cr,sp}$											
Critical edge distance for splitting failure <sup>b)</sup> $c_{cr,sp}$ [mm]	$1,0 \cdot h_{ef}$ for $h / h_{ef} \geq 2,0$											
	$4,6 h_{ef} - 1,8 h$ for $2,0 > h / h_{ef} > 1,3$											
	$2,26 h_{ef}$ for $h / h_{ef} \leq 1,3$											
Critical spacing for concrete cone failure $s_{cr,N}$ [mm]	$2 c_{cr,N}$											
Critical edge distance for concrete cone failure <sup>c)</sup> $c_{cr,N}$ [mm]	$1,5 h_{ef}$											

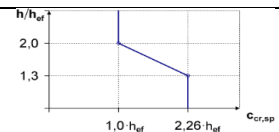

### HAS-U-...



#### Marking:

Steel grade number and length identification letter: e.g. 8 L



### Setting details for HIS-N

Anchor size		M8	M10	M12	M16	M20
Nominal diameter of drill	$d_0$ [mm]	14	18	22	28	32
Diameter of element	$d$ [mm]	12,5	16,5	20,5	25,4	27,6
Effective anchorage and drill hole depth	$h_{ef}$ [mm]	90	110	125	170	205
Minimum base material thickness	$h_{min}$ [mm]	120	150	170	230	270
Diameter of clearance hole in the fixture	$d_f$ [mm]	9	12	14	18	22
Thread engagement length; min - max	$h_s$ [mm]	8-20	10-25	12-30	16-40	20-50
Minimum spacing	$s_{min}$ [mm]	60	70	90	115	130
Minimum edge distance	$c_{min}$ [mm]	40	45	55	65	90
Critical spacing for splitting failure	$s_{cr,sp}$ [mm]	$2 C_{cr,sp}$				
Critical edge distance for splitting failure <sup>b)</sup>	$C_{cr,sp}$ [mm]	$1,0 \cdot h_{ef}$ for $h / h_{ef} \geq 2,0$				
		$4,6 h_{ef} - 1,8 h$ for $2,0 > h / h_{ef} > 1,3$				
		$2,26 h_{ef}$ for $h / h_{ef} \leq 1,3$				
Critical spacing for concrete cone failure	$s_{cr,N}$ [mm]	$2 C_{cr,N}$				
Critical edge distance for concrete cone failure <sup>c)</sup>	$C_{cr,N}$ [mm]	$1,5 h_{ef}$				
Max. torque moment <sup>a)</sup>	$T_{max}$ [Nm]	10	20	40	80	150

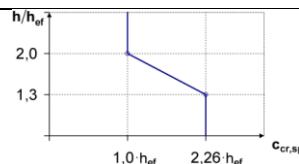

For spacing (edge distance) smaller than critical spacing (critical edge distance) the design loads have to be reduced.

a)  $h_{ef,min} \leq h_{ef} \leq h_{ef,max}$  ( $h_{ef}$ : embedment depth)

b)  $h$ : base material thickness ( $h \geq h_{min}$ )

c) The critical edge distance for concrete cone failure depends on the embedment depth  $h_{ef}$  and the design bond resistance. The simplified formula given in this table is on the save side.

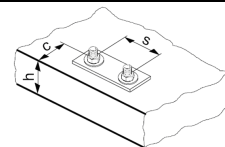

### Internally threaded sleeve HIS-(R)N...

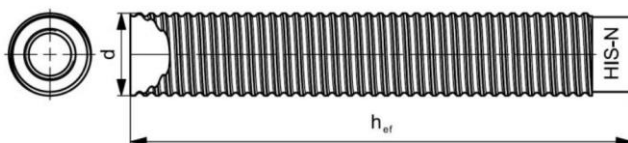

**Marking:**  
Identifying mark - HILTI and embossing "HIS-N" (for zinc coated steel)  
embossing "HIS-RN" (for stainless steel)

### Installation equipment

Anchor size		M8	M10	M12	M16	M20	M24	M27	M30	M36	M39	
Rotary hammer	HAS-U	TE 2 – TE 16				TE 40 – TE 80				Not available from Hilti		
	HIS-N	TE 2 – TE 16		TE 40 – TE 80			-					
Other tools	compressed air gun, set of cleaning brushes, dispenser											
	roughening tools TE-YRT										-	
Additional Hilti recommended tools		DD EC-1, DD 100 ... DD 160 <sup>a)</sup>									-	

a) For anchors in diamond drilled holes load values for combined pull-out and concrete cone resistance have to be reduced



Minimum roughening time  $t_{\text{roughen}}$  ( $t_{\text{roughen}} [\text{sec}] = h_{\text{ef}} [\text{mm}] / 10$ )

$h_{\text{ef}} [\text{mm}]$	$t_{\text{roughen}} [\text{sec}]$
0 to 100	10
101 to 200	20
201 to 300	30
301 to 400	40
401 to 500	50
501 to 600	60

Parameters of cleaning and setting tools

HAS-U	HIS-N	Drill bit diameters $d_0$ [mm]				Installation	
		Hammer drill (HD)	Hollow Drill Bit (HDB)	Diamond coring		Brush HIT-RB	Piston plug HIT-SZ
				Diamond coring (DD)	With roughening tool (RT)		
<b>M8</b>	-	10	-	10	-	10	-
<b>M10</b>	-	12	-	12	-	12	12
<b>M12</b>	<b>M8</b>	14	14	14	-	14	14
<b>M16</b>	<b>M10</b>	18	18	18	18	18	18
<b>M20</b>	<b>M12</b>	22	22	22	22	22	22
<b>M24</b>	<b>M16</b>	28	28	28	28	28	28
<b>M27</b>	-	30	-	30	30	30	30
-	<b>M20</b>	32	32	32	32	32	32
<b>M30</b>	-	35	35	35	35	35	35
<b>M33</b>	-	37	-	-	-	37	37
<b>M36</b>	-	40	-	-	-	40	40
<b>M39</b>	-	42	-	-	-	42	42

Associated components for the use of Hilti Roughening tool TE-YRT

Diamond coring		Roughening tool TE-YRT	Wear gauge RTG...
$d_0$ [mm]		$d_0$ [mm]	size
Nominal	measured		
18	17,9 to 18,2	18	18
20	19,9 to 20,2	20	20
22	21,9 to 22,2	22	22
25	24,9 to 25,2	25	25
28	27,9 to 28,2	28	28
30	29,9 to 30,2	30	30
32	31,9 to 32,2	32	32
35	34,9 to 35,2	35	35

## Setting instructions

\*For detailed information on installation see instruction for use given with the package of the product.



### Safety regulations.

Review the Material Safety Data Sheet (MSDS) before use for proper and safe handling! Wear well-fitting protective goggles and protective gloves when working with Hilti HIT-RE 500 V3.

### Drilling

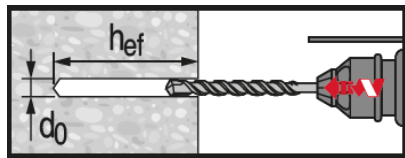

#### Hammer drilled hole

For dry and wet concrete and installation in flooded holes (no sea water).

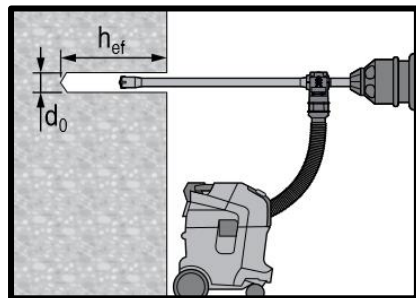

#### Hammer drilled hole with Hollow Drilled Bit (HDB)

No cleaning required.  
For dry and wet concrete, only.

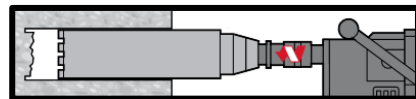

#### Diamond Coring

For dry and wet concrete, only.

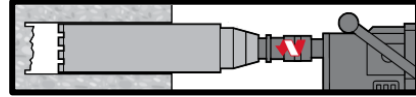

#### Diamond Coring + Roughening Tool

For dry and wet concrete only.  
Before roughening, the borehole needs to be dry.

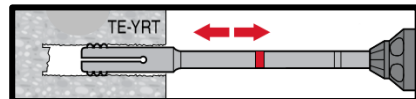

### Cleaning ( Inadequate hole cleaning=poor load values.)

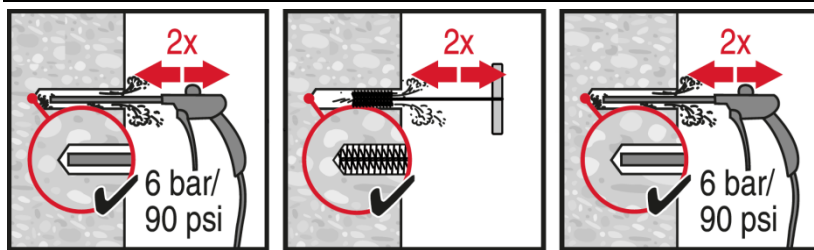

#### Hammer Drilling:

##### Compressed air cleaning (CAC)

For all drill hole diameters  $d_0$  and all drill hole depths  $h_0$ .

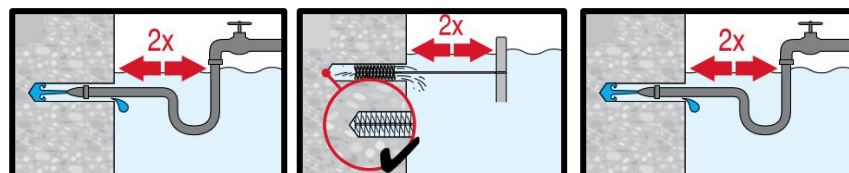

#### Hammer drilling:

##### Cleaning for under water:

For all bore hole diameters  $d_0$  and all bore hole depth  $h_0$ .

Concrete  
Chemical anchors  
Mechanical anchors  
Plastic/Light duty metal anchors  
Insulation anchors

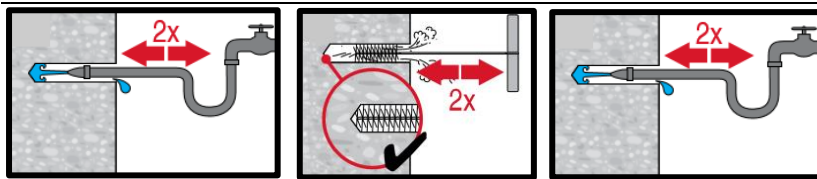

**Hammer drilled flooded holes and diamond cored holes:**

**Compressed air cleaning (CAC)** for all drill hole diameters  $d_0$  and drill hole depths  $h_0$ .

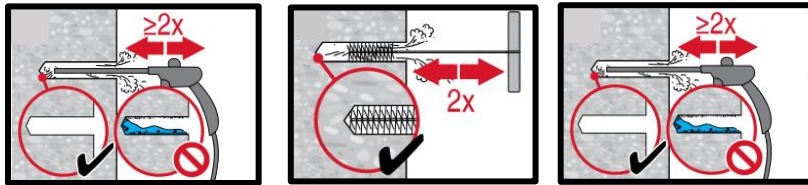

**Diamond cored holes with Hilti roughening tool:**

**Compressed air cleaning (CAC)** for all drill hole diameters  $d_0$  and drill hole depths  $h_0$ .

**Injection preparation**

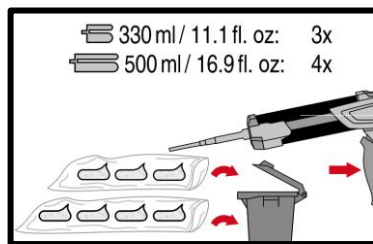
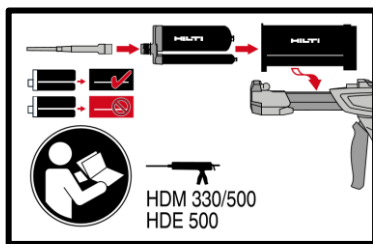

**Injection system preparation.**

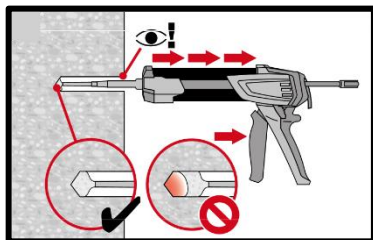

**Injection method for drill hole depth**  
 $h_{ef} \leq 250$  mm.

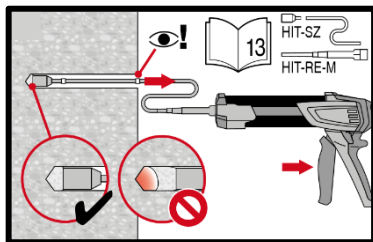
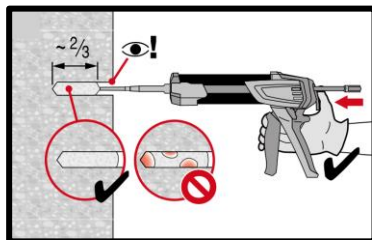

**Injection method for drill hole depth**  
 $h_{ef} > 250$  mm.

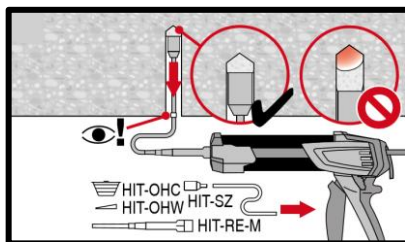
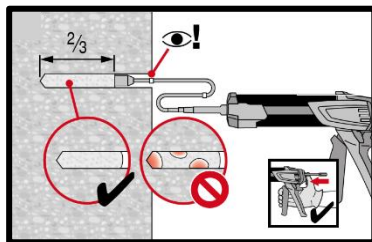

**Injection method for overhead application.**

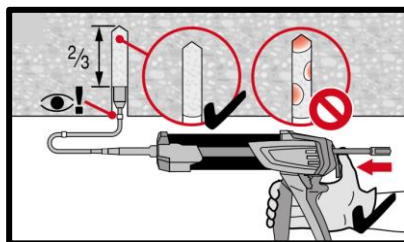

## Setting the element

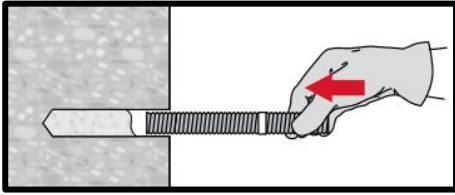

**Setting element**, observe working time " $t_{work}$ ",

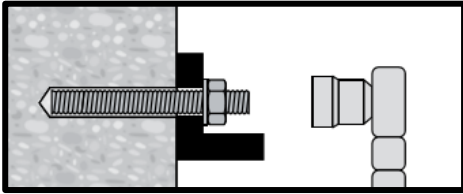

**Loading the anchor** after required curing time  $t_{cure}$  the anchor can be loaded. The applied installation torque shall not exceed  $T_{max}$ .

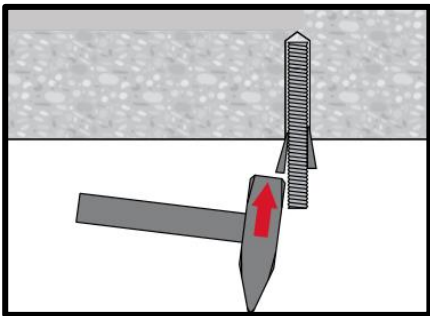

**Setting element** for overhead applications, observe working time " $t_{work}$ "

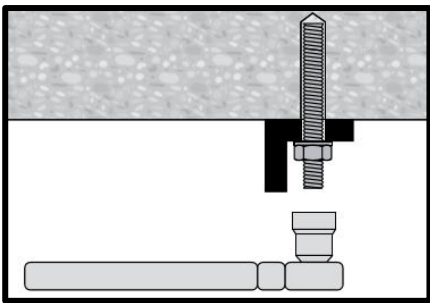

**Loading the anchor** after required curing time  $t_{cure}$  the anchor can be loaded. The applied installation torque shall not exceed  $T_{max}$ .



Concrete

Chemical anchors

Mechanical anchors

Plastic/Light duty metal anchors

Insulation anchors

# HIT-RE 500 V3 injection mortar

Anchor design (EN 1992-4) / Rebar elements / Concrete



Concrete











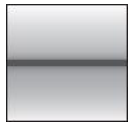

Chemical anchors

Mechanical anchors

Plastic/Light duty metal anchors

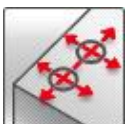
Insulation anchors

Injection mortar system	Benefits
 <p>HILTI HIT-RE 500 V3 500 ml foil pack (also available as 330 ml and 1400 ml foil pack)</p>	<ul style="list-style-type: none"> <li>- <b>SafeSet</b> technology: Simplified method of borehole preparation using either Hilti hollow drill bit for hammer drilling or Roughening tool for diamond cored applications</li> <li>- Suitable for non-cracked and cracked concrete C 20/25 to C 50/60</li> <li>- ETA approval for seismic performance category C1</li> <li>- Hilti Technical Data for seismic performance category C2</li> <li>- High loading capacity</li> <li>- Suitable for dry and water saturated concrete</li> <li>- Hilti Technical Data for under water application</li> <li>- Fastest curing epoxy mortar to speed up construction process</li> <li>- Long working time to allow installation of big diameters and/or deep embedment depths even at higher temperature</li> <li>- Cures down to -5°C</li> </ul>
 <p>Rebar B500 B (<math>\phi 8</math> - <math>\phi 40</math>)</p>	

Base material	Load conditions					
 Concrete (non-cracked)	 Concrete (cracked)	 Dry concrete	 Wet concrete	 Static/ quasi-static	 Seismic, ETA-C1 Hilti Technical Data-C2	
Installation conditions		Other informations				
 Hammer drilling	 Diamond coring	 <b>SAFE-SET</b> Hilti <b>SafeSet</b> technology	 Small edge distance and spacing	 European Technical Assessment	 CE conformity	 <b>HILTI</b> PROFIS Rebar design Software

**Approvals / certificates**

Description	Authority / Laboratory	No. / date of issue
European technical assessment <sup>a)</sup>	CSTB, Marne la Vallée	ETA-16/0143 / 2019-05-14

<sup>a)</sup> All data given in this section according to ETA-16/0143 issue 2019-05-14.

## Static and quasi-static loading (for a single anchor)

### All data in this section applies to

- Design according to TR029
- Correct setting (See setting instruction)
- No edge distance and spacing influence
- Steel failure
- Base material thickness, as specified in the table
- One typical embedment depth, as specified in the table
- Rebar B500B
- Concrete C 20/25,  $f_{ck,cube} = 25 \text{ N/mm}^2$
- Temperature range I (min. base material temp.  $-40^\circ\text{C}$ , max. long term/short term base material temp.:  $+24^\circ\text{C}/40^\circ\text{C}$ )

### Embedment depth and base material thickness for static and quasi-static loading data

Anchor- size	ETA-16/0143, issue 2019-05-14										Hilti technical data	
	$\phi 8$	$\phi 10$	$\phi 12$	$\phi 14$	$\phi 16$	$\phi 20$	$\phi 25$	$\phi 28$	$\phi 30$	$\phi 32$	$\phi 36$	$\phi 40$
Typ. embedment depth [mm]	80	90	110	125	125	170	210	270	270	300	330	360
Base material thickness [mm]	110	120	142	161	165	220	274	340	344	380	420	470

### For hammer drilled holes, hollow drill bit<sup>1)</sup> and diamond cored with roughening tool<sup>2)</sup>:

- 1) Hilti hollow drill bit available for element size  $\phi 10$ - $\phi 28$ .
- 2) Roughening tools are available for element size  $\phi 14$ - $\phi 28$ .

### Characteristic resistance

Anchor- size	ETA-16/0143, issue 2019-05-14										Hilti technical data		
	$\phi 8$	$\phi 10$	$\phi 12$	$\phi 14$	$\phi 16$	$\phi 20$	$\phi 25$	$\phi 28$	$\phi 30$	$\phi 32$	$\phi 36$	$\phi 40$	
<b>Non-cracked concrete</b>													
Tensile $N_{Rk}$ B500B	[kN]	20,1	42,4	62,0	76,9	76,9	122	167	244	244	286	330	376
Shear $V_{Rk}$ B500B		14,0	22,0	31,0	42,0	55,0	86,0	135	169	194	221	280	346
<b>Cracked concrete</b>													
Tensile $N_{Rk}$ B500B	[kN]	-	24,0	39,4	52,2	53,8	85,3	117	171	171	200	-	-
Shear $V_{Rk}$ B500B		-	22,0	31,0	42,0	55,0	86,0	135	169	194	221	-	-

- 1) Hilti hollow drill bit available for element size  $\phi 10$ - $\phi 28$ .
- 2) Roughening tools are available for element size  $\phi 14$ - $\phi 28$ .

### Design resistance

Anchor- size	ETA-16/0143, issue 2019-05-14										Hilti technical data		
	$\phi 8$	$\phi 10$	$\phi 12$	$\phi 14$	$\phi 16$	$\phi 20$	$\phi 25$	$\phi 28$	$\phi 30$	$\phi 32$	$\phi 36$	$\phi 40$	
<b>Non-cracked concrete</b>													
Tensile $N_{Rd}$ B500B	[kN]	13,4	28,0	37,8	45,8	45,8	72,7	99,8	146	146	170	164	187
Shear $V_{Rd}$ B500B		9,3	14,7	20,7	28,0	36,7	57,3	90,0	113	129	147	187	231
<b>Cracked concrete</b>													
Tensile $N_{Rd}$ B500B	[kN]	-	16,0	26,3	32,1	32,1	50,9	69,9	102	102	119	-	-
Shear $V_{Rd}$ B500B		-	14,7	20,7	28,0	36,7	57,3	90,0	113	129	147	-	-

- 1) Hilti hollow drill bit available for element size  $\phi 10$ - $\phi 28$ .
- 2) Roughening tools are available for element size  $\phi 14$ - $\phi 28$ .



### Recommended loads<sup>3)</sup>

Anchor- size		ETA-16/0143, issue 2019-05-14										Hilti technical data		
		φ8	φ10	φ12	φ14	φ16	φ20	φ25	φ28	φ30	φ32	φ36	φ40	
<b>Non-cracked concrete</b>														
Tensile N <sub>Rec</sub>	B500B	[kN]	9,6	20,0	27,0	32,7	32,7	51,9	71,3	104	104	122	117	133
Shear V <sub>Rec</sub>	B500B		6,7	10,5	14,8	20,0	26,2	41,0	64,3	80,5	92,4	105	133	165
<b>Cracked concrete</b>														
Tensile N <sub>Rec</sub>	B500B	[kN]	-	11,4	18,8	22,9	22,9	36,3	49,9	72,7	72,7	85,2	-	-
Shear V <sub>Rec</sub>	B500B		-	10,5	14,8	20,0	26,2	41,0	64,3	80,5	92,4	105	-	-

1) Hilti hollow drill bit available for element size φ10-φ28.

2) Roughening tools are available for element size φ14-φ28.

3) With overall partial safety factor for action  $\gamma=1,4$ . The partial safety factors for action depend on the type of loading and shall be taken from national regulations.

### For diamond cored holes:

#### Characteristic resistance

Anchor- size		ETA-16/0143, issue 2019-05-14										
		φ8	φ10	φ12	φ14	φ16	φ20	φ25	φ28	φ30	φ32	
Tensile N <sub>Rk</sub>	B500B	[kN]	18,1	25,4	37,3	49,5	56,5	96,1	148	226	242	286
Shear V <sub>Rk</sub>	B500B		14,0	22,0	31,0	42,0	55,0	86,0	135	169	194	221

#### Design resistance

Anchor- size		ETA-16/0143, issue 2019-05-14										
		φ8	φ10	φ12	φ14	φ16	φ20	φ25	φ28	φ30	φ32	
Tensile N <sub>Rd</sub>	B500B	[kN]	10,1	14,1	20,7	27,5	26,9	45,8	70,7	104	104	122
Shear V <sub>Rd</sub>	B500B		9,3	14,7	20,7	28,0	36,7	57,3	90,0	113	129	147

### Recommended loads<sup>a)</sup>

Anchor- size		ETA-16/0143, issue 2019-05-14										
		φ8	φ10	φ12	φ14	φ16	φ20	φ25	φ28	φ30	φ32	
Tensile N <sub>Rec</sub>	B500B	[kN]	7,2	10,1	14,8	19,6	19,2	32,7	50,5	74,2	74,2	86,9
Shear V <sub>Rec</sub>	B500B		6,7	10,5	14,8	20,0	26,2	41,0	64,3	80,5	92,4	105

a) With overall partial safety factor for action  $\gamma=1,4$ . The partial safety factors for action depend on the type of loading and shall be taken from national regulations.



## Seismic loading (for a single anchor)

### All data in this section applies to:

- Design according to TR 045
- Correct setting (See setting)
- No edge distance and spacing influence
- Steel failure
- Minimum base material thickness
- Concrete C 20/25,  $f_{ck,cube} = 25 \text{ N/mm}^2$
- Rebar B450C
- Temperature range I  
(min. base material temperature  $-40^\circ\text{C}$ , max. long term/short term base material temperature:  $+24^\circ\text{C}/40^\circ\text{C}$ )
- Installation temperature range  $-5^\circ\text{C}$  to  $+40^\circ\text{C}$
- $\alpha_{gap} = 1,0$

For hammer drilled holes, hollow drill bit<sup>2)</sup> and diamond cored with roughening tool<sup>3)</sup>:

### Embedment depth and base material thickness in case of seismic performance category C1

Anchor- size	φ8	φ10	φ12	φ14	φ16	φ20	φ25	φ28	φ30	φ32	φ36	φ40
Typical embedment depth [mm]	-	90	110	125	125	170	210	270	270	300	-	-
Base material thickness [mm]	-	120	142	161	165	220	274	340	344	380	-	-

### Characteristic resistance in case of seismic performance category C1

Anchor- size	φ8	φ10	φ12	φ14	φ16	φ20	φ25	φ28	φ30	φ32	φ36	φ40
Tensile $N_{Rk, se}$ B500B [kN]	-	23,2	36,1	45,7	45,7	72,5	99,6	145	145	170	-	-
Shear $V_{Rk, se}$ B500B [kN]	-	15,0	22,0	29,0	39,0	60,0	95,0	118	136	155	-	-

- 1) Hilti hollow drill bit available for element size  $\phi 10$ - $\phi 28$ .
- 2) Roughening tools are available for element size  $\phi 14$ - $\phi 28$ .

### Design resistance in case of seismic performance category C1

Anchor- size	φ8	φ10	φ12	φ14	φ16	φ20	φ25	φ28	φ30	φ32	φ36	φ40
Tensile $N_{Rd, se}$ B500B [kN]	-	15,5	24,1	30,5	30,5	48,4	66,4	96,8	96,8	113	-	-
Shear $V_{Rd, se}$ B500B [kN]	-	10,0	14,7	19,3	26,0	40,0	63,3	78,7	90,7	103	-	-

- 1) Hilti hollow drill bit available for element size  $\phi 10$ - $\phi 28$ .
- 2) Roughening tools are available for element size  $\phi 14$ - $\phi 28$ .

## Materials

### Mechanical properties

Anchor size	φ8	φ10	φ12	φ14	φ16	φ20	φ25	φ28	φ30	φ32	φ36	φ40
Nominal tensile strength $f_{uk}$ [N/mm <sup>2</sup> ]	B500B	550	550	550	550	550	550	550	550	550	550	550
	B450C	-	-	-	-	518	518	518	-	-	-	-
Yield strength $f_{yk}$ [N/mm <sup>2</sup> ]	B500B	500	500	500	500	500	500	500	500	500	500	500
	B450C	-	-	-	-	450	450	450	-	-	-	-
Stressed cross-section $A_s$ [mm <sup>2</sup> ]	B500B	50,3	78,5	113	154	201	314	491	616	707	804	1018
	B450C	-	-	-	-	201	314	491	-	-	-	-
Moment of resistance $W$ [mm <sup>3</sup> ]	B500B	50,3	98,2	170	269	402	785	1534	2155	2650	3217	4580
	B450C	-	-	-	-	402	785	1534	-	-	-	-

### Material quality

Part	Material
Rebar EN 1992-1-1:2004 and AC:2010	Bars and de-coiled rods class B or C with $f_{yk}$ and $k$ according to NDP or NCL of EN 1992-1-1/ NA:2013 $f_{uk} = f_{tk} = k \cdot f_{yk}$

## Setting information

**Installation temperature range:**  
-5°C to +40°C

### Service temperature range

Hilti HIT-RE 500 V3 injection mortar may be applied in the temperature ranges given below. An elevated base material temperature may lead to a reduction of the design bond resistance.

Temperature range	Base material temperature	Max. long term base material temperature	Max. short term base material temperature
Temperature range I	-40 °C to + 40 °C	+ 24 °C	+ 40 °C
Temperature range II	-40 °C to + 70 °C	+ 43 °C	+ 70 °C

### Max. short term base material temperature

Short term elevated base material temperatures are those that occur over brief intervals, e.g. as a result of diurnal cycling.

### Max. long term base material temperature

Long term elevated base material temperatures are roughly constant over significant periods of time.

### Working time and curing time

Temperature of the base material	Max. working time in which rebar can be inserted and adjusted $t_{gel}$	Min. curing time before rebar can be fully loaded $t_{cure}^{1)}$
$-5\text{ °C} \leq T_{BM} < -1\text{ °C}$	2 h	168 h
$0\text{ °C} \leq T_{BM} < 4\text{ °C}$	2 h	48 h
$5\text{ °C} \leq T_{BM} < 9\text{ °C}$	2 h	24 h
$10\text{ °C} \leq T_{BM} < 14\text{ °C}$	1,5 h	16 h
$15\text{ °C} \leq T_{BM} < 19\text{ °C}$	1 h	12 h
$20\text{ °C} \leq T_{BM} < 24\text{ °C}$	30 min	7 h
$25\text{ °C} \leq T_{BM} < 29\text{ °C}$	20 min	6 h
$30\text{ °C} \leq T_{BM} < 34\text{ °C}$	15 min	5 h
$35\text{ °C} \leq T_{BM} < 39\text{ °C}$	12 min	4,5 h
$T_{BM} = 40\text{ °C}$	10 min	4 h

1) The curing time data are valid for dry base material only. In wet base material the curing times must be doubled.

### Installation equipment

Rebar – size	φ8	φ10	φ12	φ14	φ16	φ20	φ25	φ28	φ30	φ32	φ36	φ40
Rotary hammer	TE 2 (-A) – TE 40(-A)						TE40 – TE80					
Diamond coring tools	DD EC-1, DD 100 ... DD 160 <sup>a)</sup>											-
Other tools	Compressed air gun, brush, hollow drill bit, roughening tool, dispenser, piston plug											

a) For anchors in diamond drilled holes, load values for combined pull-out and concrete cone resistance have to be reduced (see section "Setting instruction")

### Associated components for the use of Hilti Roughening tool TE-YRT

Diamond coring		Roughening tool TE-YRT	Wear gauge RTG...
$d_0$ [mm]		$d_0$ [mm]	size
Nominal	measured		
18	17,9 to 18,2	18	18
20	19,9 to 20,2	20	20
22	21,9 to 22,2	22	22
25	24,9 to 25,2	25	25
28	27,9 to 28,2	28	28
30	29,9 to 30,2	30	30
32	31,9 to 32,2	32	32
35	34,9 to 35,2	35	35

**Minimum roughening time  $t_{\text{roughen}}$  ( $t_{\text{roughen}} [\text{sec}] = h_{\text{ef}} [\text{mm}] / 10$ )**

$h_{\text{ef}} [\text{mm}]$	$t_{\text{roughen}} [\text{sec}]$
0 to 100	10
101 to 200	20
201 to 300	30
301 to 400	40
401 to 500	50
501 to 600	60

**Setting details**

Anchor size		Ø8	Ø10	Ø12		Ø14	Ø16	Ø20	Ø25	Ø28	Ø30	Ø32	Ø36	Ø40
Nominal diameter of drill bit	$d_0$ [mm]	10 12 <sup>a)</sup>	12 14 <sup>a)</sup>	14 <sup>a)</sup>	16 <sup>a)</sup>	18	20	25	30 32 <sup>a)</sup>	35	37	40	45 <sup>1)</sup>	55 <sup>1)</sup>
Effective anchorage and drill hole depth	$h_{\text{ef,min}}$ [mm]	60	60	70	70	75	80	90	100	112	120	128	144 <sup>1)</sup>	160 <sup>1)</sup>
	$h_{\text{ef,max}}$ [mm]	160	200	240	240	280	320	400	500	560	600	640	720 <sup>1)</sup>	800 <sup>1)</sup>
Minimum base material thickness	$h_{\text{min}}$ [mm]	$h_{\text{ef}} + 30\text{mm} \geq 100\text{mm}$				$h_{\text{ef}} + 2 d_0$								
Minimum spacing	$s_{\text{min}}$ [mm]	40	50	60	60	70	80	100	125	140	150	160	180 <sup>1)</sup>	200 <sup>1)</sup>
Minimum edge	$c_{\text{min}}$ [mm]	40	45	45	45	50	50	65	70	75	80	80	180 <sup>1)</sup>	200 <sup>1)</sup>
Critical spacing for splitting failure	$s_{\text{cr,sp}}$ [mm]	$2 C_{\text{cr,sp}}$												
Critical edge distance for splitting failure <sup>c)</sup>	$c_{\text{cr,sp}}$ [mm]	$1,0 \cdot h_{\text{ef}}$ for $h / h_{\text{ef}} \geq 2,0$												
		$4,6 h_{\text{ef}} - 1,8 h$ for $2,0 > h / h_{\text{ef}} > 1,3$												
		$2,26 h_{\text{ef}}$ for $h / h_{\text{ef}} \leq 1,3$												
Critical spacing for concrete cone failure	$s_{\text{cr,N}}$ [mm]	$2 C_{\text{cr,N}}$												
Critical edge distance for concrete cone failure <sup>d)</sup>	$c_{\text{cr,N}}$ [mm]	$1,5 h_{\text{ef}}$												

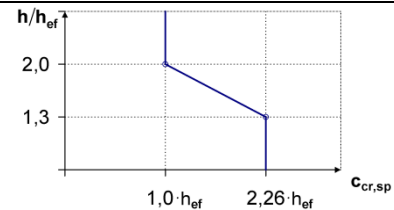





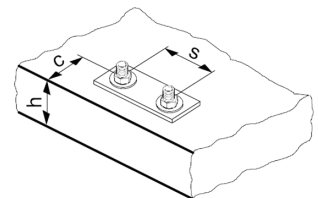

1) Additional Hilti Technical data

For spacing (edge distance) smaller than critical spacing (critical edge distance) the design loads have to be reduced.

- a) both given values for drill bit diameter can be used
- b)  $h_{\text{ef,min}} \leq h_{\text{ef}} \leq h_{\text{ef,max}}$  ( $h_{\text{ef}}$ : embedment depth)
- c)  $h$ : base material thickness ( $h \geq h_{\text{min}}$ )
- d) The critical edge distance for concrete cone failure depends on the embedment depth  $h_{\text{ef}}$  and the design bond resistance. The simplified formula given in this table is on the safe side

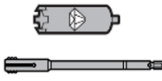

### Drilling and cleaning diameters

Rebar - size	Hammer drill (HD)	Hollow Drill Bit (HDB)	Diamond coring		Brush HIT-RB	Piston plug HIT-SZ
			Diamond coring (DD)	With roughening tool (RT)		
d <sub>0</sub> [mm]					size [mm]	
						
φ8	12 (10 <sup>a</sup> )	-	12 (10 <sup>a</sup> )	-	12 (10 <sup>a</sup> )	12
φ10	14 (12 <sup>a</sup> )	14	14 (12 <sup>a</sup> )	-	14 (12 <sup>a</sup> )	14 (12 <sup>a</sup> )
φ12	16 (14 <sup>a</sup> )	16 (14 <sup>a</sup> )	16 (14 <sup>a</sup> )	-	16 (14 <sup>a</sup> )	16 (14 <sup>a</sup> )
φ14	18	18	18	18	18	18
φ16	20	20	20	20	20	20
φ20	25	25	25	25	25	25
φ25	32	32	32	32	32	32
φ28	35	35	35	35	35	35
φ30	37	-	37	-	37	37
φ32	40	-	-	-	40	40
	-	-	42	-	42	42
φ36	45 <sup>b</sup> )	-	-	-	45 <sup>b</sup> )	45 <sup>b</sup> )
φ40	55 <sup>b</sup> )	-	-	-	55 <sup>b</sup> )	55 <sup>b</sup> )

- a) Each of two given values can be used  
 b) Additional Hilti technical data

## Setting instructions

\*For detailed information on installation see instruction for use given with the package of the product.



### Safety regulations.

Review the Material Safety Data Sheet (MSDS) before use for proper and safe handling! Wear well-fitting protective goggles and protective gloves when working with Hilti HIT-RE 500 V3.

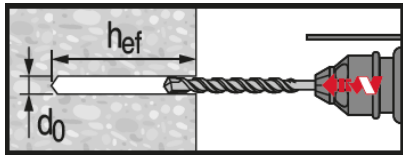

Hammer drilled hole

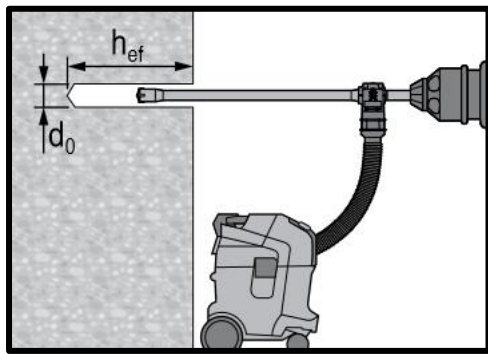

Hammer drilled hole with Hollow Drilled Bit (HDB)

No cleaning required

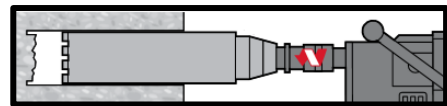

Diamond Coring

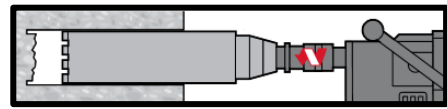

Diamond Coring + Roughening Tool

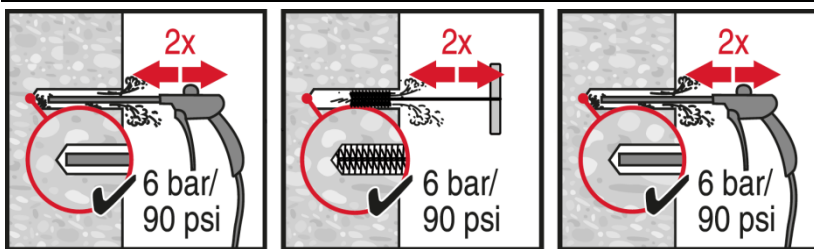
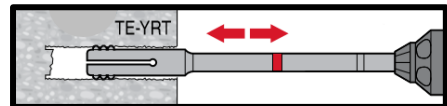

### Hammer Drilling:

#### Compressed air cleaning (CAC)

for all drill hole diameters  $d_0$  and drill hole depths  $h_0 \leq 20 \cdot d$ .

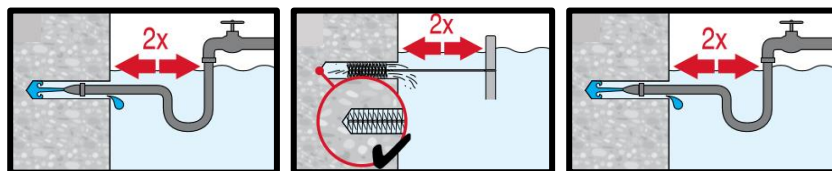

### Hammer drilling:

#### Cleaning for under water:

For all bore hole diameters  $d_0$  and all bore hole depth  $h_0$ .

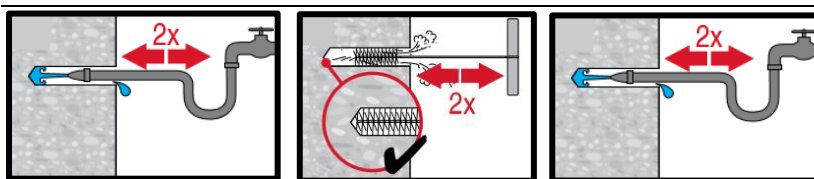

### Hammer drilled flooded holes and diamond cored holes:

#### Compressed air cleaning (CAC)

for all drill hole diameters  $d_0$  and drill hole depths  $h_0$ .

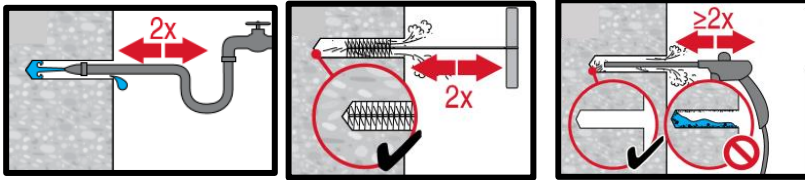
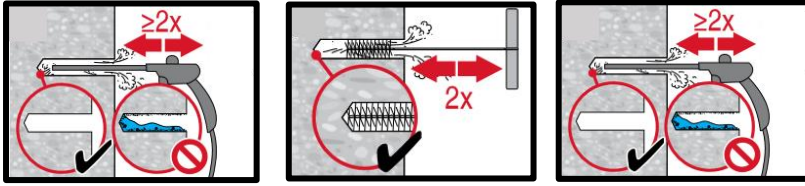

**Diamond cored holes with Hilti roughening tool:**

**Compressed air cleaning (CAC)** for all drill hole diameters  $d_0$  and drill hole depths  $h_0$ .

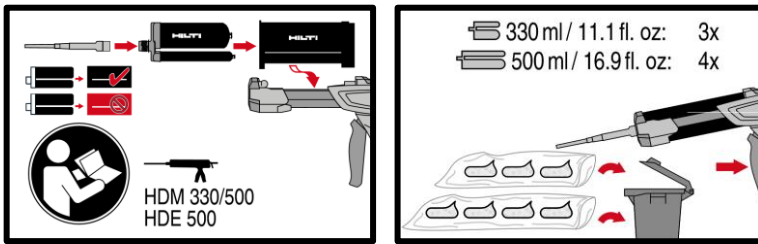

**Injection system preparation.**

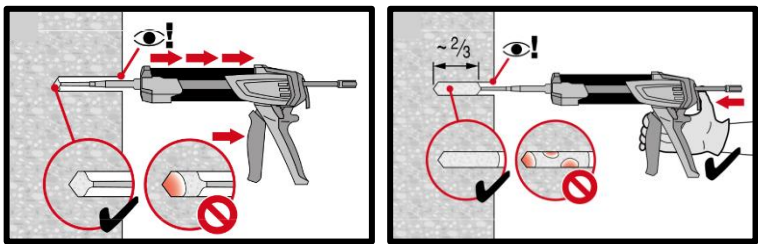

**Injection method for drill hole depth**  $h_{ef} \leq 250$  mm.

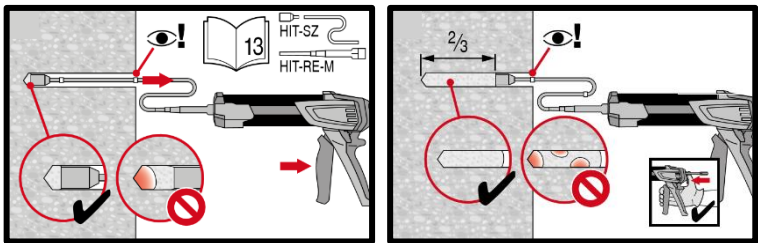

**Injection method for drill hole depth**  $h_{ef} > 250$  mm.

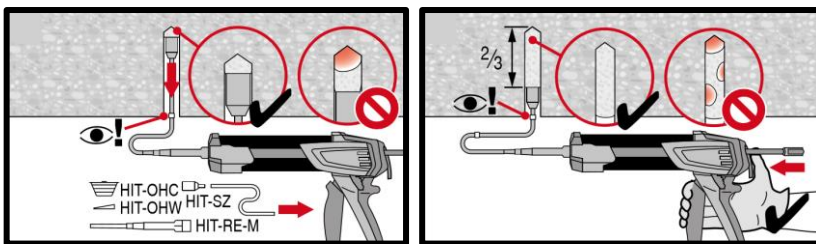

**Injection method for overhead application.**

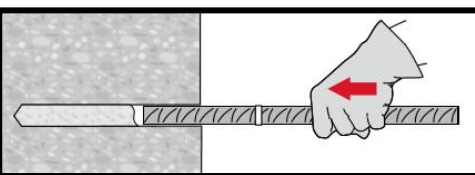

**Setting element**, observe working time " $t_{work}$ ".

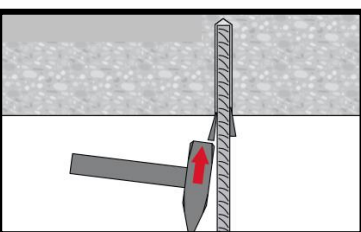

**Setting element for overhead applications**, observe working time " $t_{work}$ ".

**Loading the anchor:** After required curing time  $t_{cure}$  the anchor can be loaded.



Concrete

Chemical anchors

Mechanical anchors

Plastic/Light duty metal anchors

Insulation anchors



# HIT-RE 500 V3 injection mortar

Rebar design (EOTA TR023) / Rebar elements / Concrete

## Injection mortar system



Foil pack: HIT-RE 500 V3  
(available in 330, 500 and 1400 ml cartridges)



Rebar B500 B  
( $\phi 8 - \phi 40$ )

## Benefits

- **SafeSet** technology: Simplified method of borehole preparation using either Hilti hollow drill bit for hammer drilling or Roughening tool for diamond cored applications
- Suitable for concrete C 12/15 to C 50/60
- High loading capacity
- Suitable for dry and water saturated concrete
- Non-corrosive to rebar elements
- Long working time at elevated temperatures
- Cures down to  $-5^{\circ}\text{C}$
- Odourless epoxy
- Fire time exposure up to 4h

## Base material



Concrete (non-cracked)



Concrete (cracked)

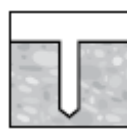

Dry concrete



Wet concrete

## Load conditions



Static/  
quasi-static



Seismic,  
ETA-C1



Fire  
resistance

## Installation conditions

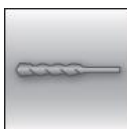

Hammer  
drilling



Diamond  
coring

**SAFESET**

Hilti **SafeSet**  
technology

## Other informations



European  
Technical  
Assessment



CE  
conformity



PROFIS  
Rebar  
design  
Software

## Approvals / certificates

Description	Authority / Laboratory	No. / date of issue
European technical assessment <sup>a)</sup>	CSTB, Marne la Vallée	ETA-16/0142 / 2019-05-27
Fire evaluation	CSTB, Marne la Vallée	MRF 1526054277/B

b) All data given in this section according to ETA-16/0142 issue 2019-05-27.



## Static and quasi-static loading

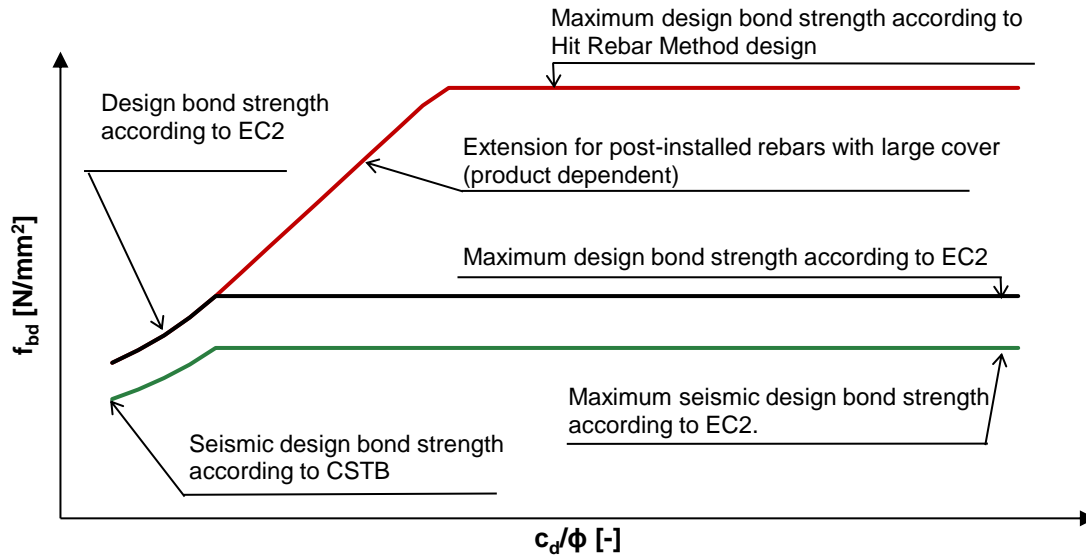

Effective limit on bond stress for post-installed rebar using Hilti mortar systems and design bond strength values as provided by the EC2.

### Static EC2 design, small concrete cover (see section 3.2.1)

#### Design bond strength in N/mm<sup>2</sup> according to ETA 16/0142 for good bond conditions

All allowed hammer drilling methods									
Rebar - size	Concrete class								
	C12/15	C16/20	C20/25	C25/30	C30/37	C35/45	C40/50	C45/55	C50/60
φ8 - φ32	1,6	2,0	2,3	2,7	3,0	3,4	3,7	4,0	4,3
φ34	1,6	2,0	2,3	2,6	2,9	3,3	3,6	3,9	4,2
φ36	1,6	1,9	2,2	2,6	2,9	3,2	3,5	3,8	4,1
φ40	1,5	1,8	2,1	2,5	2,8	3,1	3,4	3,7	3,9
Diamond coring wet									
φ8 - φ12	1,6	2,0	2,3	2,7	3,0	3,4	3,7	4,0	4,0
φ14 - φ 16	1,6	2,0	2,3	2,7	3,0	3,4	3,7	3,7	3,7
φ18 - φ32	1,6	2,0	2,3	2,7	3,0	3,4	3,4	3,4	3,4
φ34	1,6	2,0	2,3	2,6	2,9	3,3	3,3	3,3	3,3
φ36	1,6	1,9	2,2	2,6	2,9	3,2	3,2	3,2	3,2
φ40	1,5	1,8	2,1	2,5	2,8	2,8	2,8	2,8	2,8

For poor bond conditions multiply the values by 0,7.

Static Hit Rebar design method, large concrete cover (see section 3.2.2)

Pullout design bond strength [ $f_{bd,po} = \tau_{Rk}/\gamma_{Mp}$ ] in N/mm<sup>2</sup> for good bond conditions

**Non-cracked concrete C20/25, all allowed drilling methods**

Temperature range	Drilling method	Rebar - size											
		φ8	φ10	φ12	φ14	φ16	φ20	φ25	φ28	φ30	φ32	φ36	φ40
I: 40°C/24° C	Hammer drilled holes	6,3	9,5	9,5	9,5	9,5	9,5	8,7	8,7	8,7	8,7	6,7	7,9
	Hammer drilled holes with hollow drill bit	-	-	9,5	9,5	9,5	9,5	8,7	8,7	-	-	-	-
	Diamond cored holes with roughening tool	-	-	-	9,5	9,5	9,5	8,7	8,7	-	-	-	-
	Diamond cored holes	5	5	5	5	5	5	5	5,3	5,3	5,3	-	-
	Hammer drilled holes in water filled holes	3,8	5,7	5,7	5,7	5,7	5,7	5,2	5,2	5,2	5,2	-	-
II: 70°C/43° C	Hammer drilled holes	4,7	7,3	7,3	7,3	6,7	6,7	6,7	6,3	6,3	6,3	5,7	5,0
	Hammer drilled holes with hollow drill bit	-	-	7,3	7,3	6,7	6,7	6,7	6,3	-	-	-	-
	Diamond cored holes with roughening tool	-	-	-	7,3	6,7	6,7	6,7	6,3	-	-	-	-
	Diamond cored holes	3,6	3,6	3,6	3,6	3,1	3,3	3,3	3,3	3,3	3,3	-	-
	Hammer drilled holes in water filled holes	2,6	4,3	4,3	4,3	4,3	4,0	4,0	4,0	3,8	3,8	-	-

**Cracked concrete C20/25, all allowed drilling methods**

I: 40°C/24° C	Hammer drilled holes	3	5,7	6,3	6,3	6,3	6,7	6,7	7,3	7,3	7,3		
	Hammer drilled holes with hollow drill bit	-	-	6,3	6,3	6,3	6,7	6,7	7,3	-	-	-	-
	Diamond cored holes with roughening tool	-	-	-	6,3	6,3	6,7	6,7	7,3	-	-	-	-
II: 70°C/43° C	Hammer drilled holes	2,7	4,7	5,3	5,3	5,3	5,3	5,3	5,3	5,3	5,3		
	Hammer drilled holes with hollow drill bit	-	-		5,3	5,3	5,3	5,3	5,3	-	-	-	-
	Diamond cored holes with roughening tool	-	-	-	5,3	5,3	5,3	5,3	5,3	-	-	-	-

For poor bond conditions multiply values by 0,7.

**Increasing factors in concrete for  $f_{bd,po}$**

Drilling method	Concrete class	Rebar-size											
		φ8	φ10	φ12	φ14	φ16	φ20	φ25	φ28	φ30	φ32	φ36	φ40
Hammer drilled holes	C 30/37	1,04											
Hammer drilled holes with hollow drill bit	C40/50	1,07											
Diamond cored holes	C50/60	1,09											
Diamond cored holes with roughening tool	C 30/37 - C50/60	1,0										-	

## Minimum anchorage length and minimum lap length

The minimum anchorage length  $l_{b,min}$  and the minimum lap length  $l_{0,min}$  according to EN 1992-1-1 shall be multiplied by relevant **Amplification factor  $\alpha_{lb}$**  in the table below.

### Amplification factor $\alpha_{lb}$ for the min. anchorage length and min. lap length

All allowed hammer drilling methods and diamond coring with Hilti roughening tool TE-YRT									
Rebar - size	Concrete class								
	C12/15	C16/20	C20/25	C25/30	C30/37	C35/45	C40/50	C45/55	C50/60
$\phi 8 - \phi 40$	1,0								
Diamond coring wet									
$\phi 8 - \phi 12$	1,0								
$\phi 14 - \phi 36$	Linear interpolation between diameters								
$\phi 40$	1,0	1,0	1,0	1,0	1,2	1,3	1,4	1,4	1,4

### Anchorage length for characteristic steel strength $f_{yk}=500 \text{ N/mm}^2$ for good conditions

Hammer drilling									
Rebar-size	Concrete class	$f_{bd}$ [N/mm <sup>2</sup> ]	$f_{bd,p}$ [N/mm <sup>2</sup> ]	$l_{0,min}^{1)}$ [mm]	$l_{b,min}^{2)}$ [mm]	$l_{bd,y,\alpha_2=1}^{3)}$ [mm]	$l_{bd,y,\alpha_2=0.7}^{4)}$ [mm]	$l_{bd,y,HRM,\alpha_2<0.7}^{5)}$ [mm]	$l_{max}^{6)}$ [mm]
$\phi 8$	C20/25	2,3	6,3	200	113	378	265	138	1000
	C50/60	4,3	6,9	200	100	202	142	126	1000
$\phi 10$	C20/25	2,3	9,3	213	142	473	331	142	1000
	C50/60	4,3	10,2	200	100	253	177	107	1000
$\phi 12$	C20/25	2,3	9,3	255	170	567	397	170	1200
	C50/60	4,3	10,2	200	120	303	212	128	1200
$\phi 14$	C20/25	2,3	9,3	298	198	662	463	198	1400
	C50/60	4,3	10,2	210	140	354	248	149	1400
$\phi 16$	C20/25	2,3	9,3	340	227	756	529	234	1600
	C50/60	4,3	10,2	240	160	404	283	171	1600
$\phi 20$	C20/25	2,3	9,3	435	284	945	662	356	2000
	C50/60	4,3	10,2	300	200	506	354	213	2000
$\phi 25$	C20/25	2,3	8,7	532	354	1181	827	539	2500
	C50/60	4,3	9,4	375	250	632	442	289	2500
$\phi 28$	C20/25	2,3	8,7	595	397	1323	926	663	2800
	C50/60	4,3	9,4	420	280	708	495	354	2800
$\phi 30$	C20/25	2,3	8,7	638	425	1418	992	751	3000
	C50/60	4,3	9,4	450	300	758	531	402	3000
$\phi 32$	C20/25	2,3	8,7	681	454	1512	1059	844	3200
	C50/60	4,3	9,4	480	320	809	566	451	3200
$\phi 36$	C20/25	2,2	5,2	534	540	1779	1245	753	3200
	C50/60	3,2	5,7	367	540	1223	856	686	3200
$\phi 40$	C20/25	2,1	4,8	621	621	2070	1449	906	3200
	C50/60	2,8	5,2	466	600	1553	1087	836	3200

- 1) Minimum anchorage length for overlap joint
- 2) Minimum anchorage length for simply supported connections
- 3) Anchorage length for simply supported connections in case of:  $\alpha_1 = \alpha_2 = \alpha_3 = \alpha_4 = \alpha_5 = 1$  - (design for yielding)
- 4) Anchorage length for simply supported connections in case of:  $\alpha_1 = \alpha_3 = \alpha_4 = \alpha_5 = 1$ ;  $\alpha_2 = 0.7$  - (design for yielding)
- 5) Anchorage length with HIT Rebar design Method (HRM) for simply supported connections in case of:  $\alpha_1 = \alpha_3 = \alpha_4 = \alpha_5 = 1$ ;  $\alpha_2 < 0.7$ . Only if an adequate concrete cover is applied.
- 6) Maximum feasible embedment depth due to mortar installation limitations.

## Seismic loading

Seismic data according to ETA-16/0142

Design bond strength in N/mm<sup>2</sup> for good bond conditions

All allowed hammer drilling methods, diamond coring dry and diamond coring with Hilti roughening tool TE-YRT								
Rebar - size	Concrete class							
	C16/20	C20/25	C25/30	C30/37	C35/45	C40/50	C45/55	C50/60
φ10 - φ32	2,0	2,3	2,7	3,0	3,4	3,7	4,0	4,3
φ34	2,0	2,3	2,6	2,9	3,3	3,6	3,9	4,2
φ36	1,9	2,2	2,6	2,9	3,2	3,5	3,8	4,1
φ40	1,8	2,1	2,5	2,8	3,1	3,4	3,7	3,9

For poor bond conditions multiply the values 0,7.

Design bond strength in N/mm<sup>2</sup> for good bond conditions

Diamond coring wet								
Rebar - size	Concrete class							
	C16/20	C20/25	C25/30	C30/37	C35/45	C40/50	C45/55	C50/60
φ12	2,0	2,3	2,7	3,0	3,4	3,7	4,0	4,0
φ14 - φ32	2,0	2,3	2,7	3,0	3,3	3,4	3,4	3,4
φ34	1,9	2,3	2,3	2,3	2,3	2,3	2,3	2,3
φ36	1,9	2,2	2,2	2,2	2,2	2,2	2,2	2,2
φ40	1,8	2,1	2,1	2,1	2,1	2,1	2,1	2,1

For poor bond conditions multiply the values 0,7.

**Fire resistance**

**Temperature reduction factor  $k_{fi}(\theta)$**

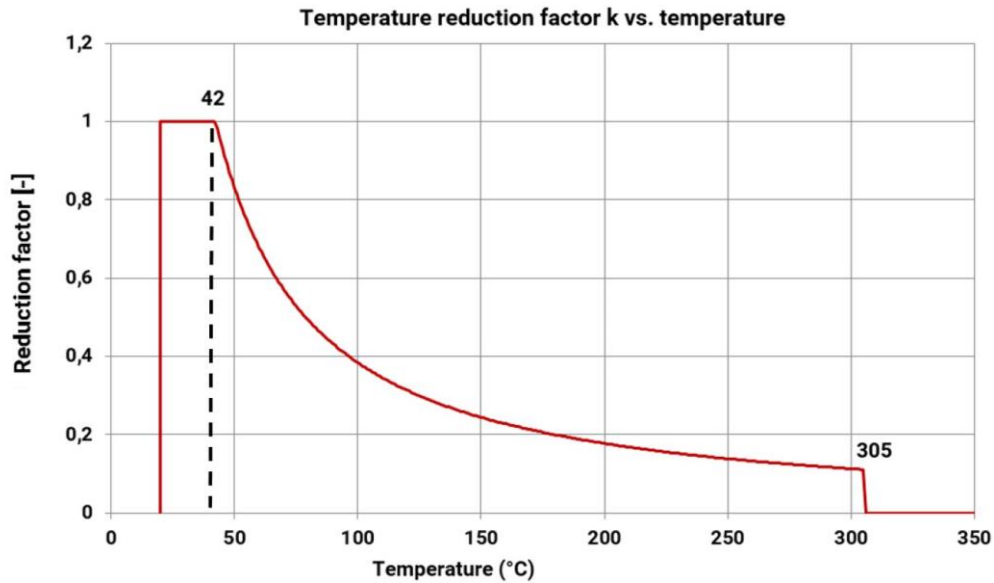

The analytic equation that describe the variation of  $k_{fi}(\theta)$  with temperature is given by the following function:

If  $45^{\circ}\text{C} \leq \theta \leq 152^{\circ}\text{C}$ :  $k_{fi}(\theta) = \frac{f_{bm}(\theta)}{f_{bm,rqd,d}} \leq 1,0$  in  $^{\circ}\text{C}$   
 If  $\theta < 45^{\circ}\text{C}$   $k_{fi}(\theta) = 1,0$   
 If  $\theta > 152^{\circ}\text{C}$   $k_{fi}(\theta) = 0,0$

With:  
 $f_{bm}(\theta) = 1178,2 \cdot \theta^{-1,255}$  in  $^{\circ}\text{C}$

According to MRF 1526054277 / B

**a) Anchoring application**

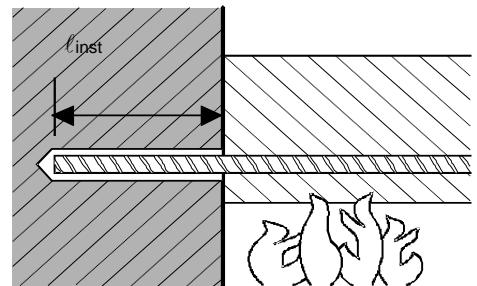

Anchoring application beam-wall connection with a concrete cover of 20 mm

Maximum force in rebar in conjunction with HIT-RE 500 V3 as a function of embedment depth for the fire resistance classes F30 to F240 (yield strength  $f_{yk} = 500 \text{ N/mm}^2$  and concrete class C20/25) according EC2

Rebar-size	Max. $F_{s,T}$ [kN]	$l_{inst}$ [mm]	Fire resistance of bar in [kN]					
			R30	R60	R90	R120	R180	R240
$\phi 8$	16,8	100	3,8	1,3	0,5	0,2	0,0	0,0
		140	7,2	4,3	2,3	1,5	0,7	0,2
		180	10,7	7,8	5,6	3,9	2,1	1,3
		220	14,2	11,2	9,1	7,4	4,6	2,9
		250		13,8	11,7	10,0	7,1	4,8
		290			15,1	13,5	10,6	8,1
		310				15,2	12,3	9,8
		330	16,8	16,8			14,0	11,6
		370			16,8	16,8		15,0
		390					16,8	16,8

Maximum force in rebar in conjunction with HIT-RE 500 V3 as a function of embedment depth for the fire resistance classes F30 to F240 (yield strength  $f_{yk} = 500 \text{ N/mm}^2$  and concrete class C20/25) according EC2

Rebar-size	Max. $F_{s,T}$ [kN]	$l_{inst}$ [mm]	Fire resistance of bar in [kN]					
			R30	R60	R90	R120	R180	R240
$\phi 10$	26,2	110	5,8	2,4	1,1	0,6	0,0	0,0
		150	10,1	6,5	3,8	2,5	1,2	0,5
		190	14,5	10,8	8,1	6,0	3,3	2,0
		230	18,8	15,1	12,4	10,3	6,7	4,4
		300	26,2	22,7	20,0	17,9	14,3	11,2
		340		24,3	22,2	18,6	15,6	
		360		24,4	20,8	17,7		
		380		26,2	23,0	19,9		
		410		26,2	23,1	20,0		
		440		26,2	26,2	23,1		
$\phi 12$	37,7	140	10,9	6,5	3,5	2,3	1,0	0,3
		200	18,7	14,3	11,0	8,5	4,8	3,0
		260	26,5	22,1	18,8	16,3	12,0	8,3
		320	34,3	29,9	26,6	24,1	19,8	16,1
		350	37,7	33,8	30,5	28,0	23,7	20,0
		390		35,7	33,2	28,9	25,2	
		410		37,7	35,8	31,5	27,8	
		430		37,7	34,1	30,4		
		460		37,7	34,3	31,3		
		490		37,7	37,7	34,3		
$\phi 14$	51,3	160	15,7	10,6	6,7	4,4	2,3	1,1
		220	24,8	19,7	15,8	12,9	8,0	5,1
		280	33,9	28,8	24,9	22,0	17,0	12,7
		340	43,0	37,9	34,1	31,1	26,1	21,8
		400	51,3	47,0	43,2	40,2	35,2	30,9
		430		47,7	44,8	39,7	35,4	
		460		49,3	44,3	40,0		
		480		51,3	47,3	43,0		
		510		51,3	47,6	44,0		
		540		51,3	51,3	47,6		
$\phi 16$	67	180	21,4	15,5	11,2	7,8	4,3	2,5
		240	31,8	25,9	21,6	18,2	12,5	8,2
		300	42,2	36,3	32,0	28,6	22,9	18,0
		360	52,6	46,8	42,4	39,0	33,3	28,4
		450	67,0	62,4	58,0	54,6	48,9	44,0
		480		63,2	59,8	54,1	49,2	
		510		65,1	59,3	54,4		
		530		67,0	62,8	57,8		
		560		67,0	63,0	58,0		
		590		67,0	67,0	63,0		
$\phi 20$	104,7	220	35,5	28,1	22,6	18,5	11,4	7,3
		280	48,5	41,1	35,6	31,5	24,3	18,1
		340	61,5	54,1	48,6	44,5	37,3	31,1
		400	74,5	67,1	61,7	57,5	50,3	44,1
		460	87,5	80,1	74,7	70,5	63,3	57,1
		540	104,7	97,5	92,0	87,8	80,6	74,5
		580		100,7	96,5	89,3	83,1	
		600		104,7	100,8	93,6	87,5	
		620		104,7	98,0	91,8		
		660		104,7	100,5	93,6		
680	104,7	104,7		100,5				

Anchoring application beam-wall connection with a concrete cover of 40 mm

Rebar-size	Max. F <sub>s,T</sub> [kN]	l <sub>inst</sub> [mm]	Fire resistance of bar in [kN]					
			R30	R60	R90	R120	R180	R240
φ8	16,8	100	4,9	1,8	0,8	0,4	0,0	0,0
		140	8,4	5,0	2,9	1,9	0,7	0,2
		180	11,9	8,5	6,2	4,5	2,3	1,3
		220	15,4	11,9	9,7	8,0	4,9	3,1
		240	16,8	13,7	11,4	9,7	6,6	4,3
		280		16,8	14,9	13,2	10,1	7,6
		310	16,8		16,8	16,8	15,8	12,7
		330		14,4			11,9	
		360	16,8	14,5				
		390	16,8	16,8				
φ10	26,2	110	7,3	3,1	1,5	0,9	0,0	0,0
		150	11,6	7,3	4,5	3,0	1,3	0,6
		190	15,9	11,7	8,9	6,7	3,5	2,1
		230	20,3	16,0	13,2	11,0	7,2	4,6
		290	26,2	22,5	19,7	17,5	13,7	10,5
		330		26,2	24,0	21,9	18,0	14,9
		350	26,2		26,2	26,2	24,0	20,2
		370		22,3			19,2	
		410	26,2	23,6				
		440	26,2	26,2				
φ12	37,7	140	12,6	7,5	4,3	2,8	1,1	0,3
		200	20,4	15,3	11,9	9,3	5,2	3,2
		260	28,2	23,1	19,7	17,1	12,5	8,8
		320	36,0	30,9	27,6	25,0	20,3	16,6
		340	37,7	33,5	30,2	27,6	22,9	19,2
		380		37,7	35,4	32,8	28,1	24,4
		400	37,7		37,7	37,7	35,4	30,7
		420		33,3			29,6	
		460	37,7	34,8				
		490	37,7	37,7				
φ14	51,3	160	17,8	11,8	7,9	5,2	2,5	1,2
		220	26,9	20,9	17,0	13,9	8,5	5,5
		280	36,0	30,0	26,1	23,0	17,6	13,2
		340	45,1	39,1	35,2	32,1	26,7	22,4
		390	51,3	46,7	42,8	39,7	34,3	29,9
		430		51,3	48,8	45,8	40,4	36,0
		450	51,3		51,3	51,3	48,8	43,4
		470		46,4			42,1	
		510	51,3	48,1				
		540	51,3	51,3				
φ16	67	180	23,8	16,9	12,5	9,0	4,6	2,7
		240	34,2	27,3	22,9	19,4	13,2	8,7
		300	44,6	37,7	33,3	29,8	23,6	18,6
		360	55,0	48,2	43,7	40,2	34,0	29,0
		430	67,0	60,3	55,8	52,3	46,1	41,2
		470		67,0	62,7	59,3	53,1	48,1
		500	67,0		67,0	67,0	64,5	58,3
		520		61,7			56,8	
		560	67,0	63,7				
		580	67,0	67,0				

Concrete

Chemical anchors

Mechanical anchors

Plastic/Light duty metal anchors

Insulation anchors

Rebar-size	Max. F <sub>s,T</sub> [kN]	l <sub>inst</sub> [mm]	Fire resistance of bar in [kN]					
			R30	R60	R90	R120	R180	R240
φ20	104,7	220	38,4	29,8	24,2	19,9	12,2	7,8
		300	55,7	47,2	41,6	37,3	29,5	23,3
		380	73,1	64,5	58,9	54,6	46,8	40,6
		460	90,4	81,9	76,3	71,9	64,2	57,9
		530	104,7	97,0	91,4	87,1	79,3	73,1
		570		104,7	100,1	95,8	88,0	81,8
		600	104,7		104,7	102,3	94,5	88,3
		620		104,7		98,9	92,6	
		650				104,7	99,1	
		680					104,7	104,7
φ25	163,6	280	64,2	53,6	46,6	41,1	31,4	23,7
		370	88,6	77,9	70,9	65,5	55,8	48,0
		460	113,0	102,3	95,3	89,9	80,2	72,4
		550	137,4	126,7	119,7	114,3	104,6	96,8
		650	163,6	153,8	146,8	141,4	131,7	123,9
		690		163,6	157,7	152,2	142,5	134,7
		720	163,6		163,6	160,4	150,7	142,9
		740		163,6		156,1	148,3	
		770				163,6	156,4	
		800					163,6	163,6
φ28	205,3	310	81,1	69,1	61,3	55,2	44,3	35,6
		370	99,3	87,3	79,5	73,4	62,5	53,8
		430	117,5	105,5	97,7	91,6	80,7	72,0
		490	135,7	123,7	115,9	109,8	98,9	90,2
		550	153,9	141,9	134,1	128,0	117,2	108,4
		610	172,1	160,1	152,3	146,2	135,4	126,6
		670	190,3	178,3	170,5	164,4	153,6	144,8
		720	205,3	193,5	185,7	179,6	168,7	160,0
		760		205,3	197,8	191,8	180,9	172,2
		790	205,3		205,3	200,9	190,0	181,3
		810		205,3		196,1	187,3	
		850				205,3	199,5	
870					205,3	205,3		
φ32	268,1	350	106,5	92,8	83,9	76,9	64,5	54,6
		410	127,3	113,6	104,7	97,8	85,3	75,4
		470	148,1	134,5	125,5	118,6	106,1	96,2
		530	168,9	155,3	146,3	139,4	127,0	117,0
		590	189,7	176,1	167,1	160,2	147,8	137,8
		650	210,6	196,9	187,9	181,0	168,6	158,6
		710	231,4	217,7	208,7	201,8	189,4	179,4
		820	268,1	255,8	246,9	240,0	227,5	217,6
		860		268,1	260,8	253,8	241,4	231,4
		890	268,1		268,1	264,2	251,8	241,8
		910		268,1		258,7	248,8	
		940				268,1	259,2	
		970					268,1	268,1



## b) Overlap joint application

Max. bond stress,  $f_{bd,FIRE}$ , depending on actual clear concrete cover for classifying the fire resistance.

It must be verified that the actual force in the bar during a fire,  $F_{s,T}$ , can be taken up by the bar connection of the selected length,  $l_{inst}$ . Note: Cold design for ULS is mandatory.

$$F_{s,T} \leq (l_{inst} - c_f) \cdot \phi \cdot \pi \cdot f_{bd,FIRE} \quad \text{where: } (l_{inst} - c_f) \geq l_s;$$

$l_s$  = lap length

$\phi$  = nominal diameter of bar

$l_{inst} - c_f$  = selected overlap joint length; this must be at least  $l_s$ ,

but may not be assumed to be more than  $80 \phi$

$f_{bd,FIRE}$  = bond stress when exposed to fire

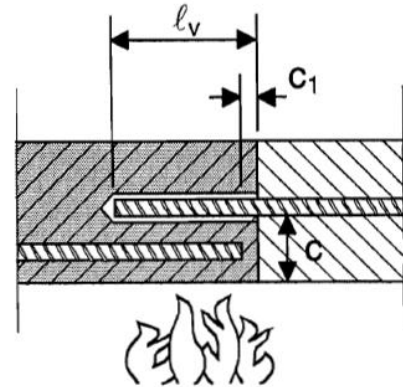

**Critical temperature-dependent bond stress,  $f_{bd,FIRE}$ , concerning “overlap joint” for Hilti HIT-RE 500 V3 injection adhesive in relation to fire resistance class and required minimum concrete coverage c.**

Clear concrete cover c [mm]	Max. bond stress, $\tau_c$ [N/mm <sup>2</sup> ]					
	R30	R60	R90	R120	R180	R240
30						
40	0,8					
50	1,1					
60	1,5					
70	2,1	0,9				
80	2,9	1,2				
90	3,5	1,5	0,9			
100		1,8	1,1	0,8		
110		2,3	1,4	1,0		
120		2,8	1,6	1,2		
130		3,4	2,0	1,4	0,9	
140		3,5	2,3	1,6	1,0	
150			2,8	1,9	1,1	0,8
160			3,3	2,2	1,3	0,9
170			3,5	2,5	1,5	1,1
180				2,9	1,7	1,2
190				3,4	1,9	1,4
200				3,5	2,2	1,5
210					2,5	1,7
220					2,8	1,9
230					3,1	2,1
240					3,5	2,3
250						2,6
260						2,9
270						3,2
280						3,5
290						

## Materials

### Properties of reinforcement

Designation	Material
Reinforcing bars (rebars)	
Rebar EN 1992-1-1	Bars and de-coiled rods class B or C with $f_{yk}$ and $k$ according to NDP or NCL of EN 1992-1-1 $f_{uk} = f_{tk} = k \cdot f_{yk}$

### Fitness for use

Some creep tests have been conducted in accordance with ETAG guideline 001 part 5 and TR 023 in the following conditions: **in dry environment at 50 °C during 90 days.**

These tests show an excellent behaviour of the post-installed connection made with HIT-RE 500 V3: low displacements with long term stability, failure load after exposure above reference load.

### Resistance to chemical substances

Chemicals tested	Content (%)	Resistance	Chemical tested	Content (%)	Resistance
Toluene	47,5	+	Sodium hydroxide 20%	100	-
Iso-octane	30,4	+	Triethanolamine	50	-
Heptane	17,1	+	Butylamine	50	-
Methanol	3	+	Benzyl alcohol	100	-
Butanol	2	+	Ethanol	100	-
Toluene	60	+	Ethyl acetate	100	-
Xylene	30	+	Methyl ethyl ketone (MEK)	100	-
Methylnaphthalene	10	+	Trichlorethylene	100	-
Diesel	100	+	Lutensit TC KLC 50	3	+
Petrol	100	+	Marlophen NP 9,5	2	+
Methanol	100	-	Water	95	+
Dichloromethane	100	-	Tetrahydrofurane	100	-
Mono-chlorobenzene	100	o	Demineralized water	100	+
Ethylacetat	50	-	Salt water	saturated	+
Methylisobutylketone	50	-	Salt spray testing	-	+
Salicylic acid-	50	+	SO <sub>2</sub>	-	+
Acetophenon	50	+	Enviroment/wheather	-	+
Acetic acid	50	-	Oil for formwork (forming oil)	100	+
Propionic acid	50	-	Concentrate plasticizer	-	+
Sulfuric acid	100	-	Concrete potash solution	-	+
Nitric acid	100	-	Concrete potash solution	-	+
Hydrochloric acid	36	-	Saturated suspension of borehole cuttings	-	+
Potassium hydroxide	100	-			

- + **Resistant**
- **Not resistant**
- o **Partially Resistant**

### Electrical Conductivity

HIT-RE 500 V3 in the hardened state **is not conductive electrically**. Its electric resistivity is  $66 \cdot 10^{12} \Omega \cdot m$  (DIN IEC 93 – 12.93). It is adapted well to realize electrically insulating anchorings (ex: railway applications, subway).

### Installation temperature range

-5°C to +40°C

### Service temperature range

Hilti HIT-RE 500 V3 injection mortar may be applied in the temperature ranges given below. An elevated base material temperature may lead to a reduction of the design bond resistance.

Temperature range	Base material temperature	Maximum long term base material temperature	Maximum short term base material temperature
Temperature range I	-40 °C to +80 °C	+50 °C	+80 °C

### Max short term base material temperature

Short-term elevated base material temperatures are those that occur over brief intervals, e.g. as result of diurnal cycling.

### Max long term base material temperature

Long-term elevated base material temperatures are roughly constant over significant periods of time.

### Working time and curing time <sup>1)</sup>

Temperature of the base material	Working time in which rebar can be inserted and adjusted $t_{gel}$	Initial curing time $t_{cure,ini}$	Curing time before rebar can be fully loaded $t_{cure}$
$5\text{ °C} \leq T_{BM} < -1\text{ °C}$	2 h	48 h	168 h
$0\text{ °C} \leq T_{BM} < 4\text{ °C}$	2 h	24 h	48 h
$5\text{ °C} \leq T_{BM} < 9\text{ °C}$	2 h	16 h	24 h
$10\text{ °C} \leq T_{BM} < 14\text{ °C}$	1,5 h	12 h	16 h
$15\text{ °C} \leq T_{BM} < 19\text{ °C}$	1 h	8 h	16 h
$20\text{ °C} \leq T_{BM} < 24\text{ °C}$	30 min	4 h	7 h
$25\text{ °C} \leq T_{BM} < 29\text{ °C}$	20 min	3,5 h	6 h
$30\text{ °C} \leq T_{BM} < 34\text{ °C}$	15 min	3 h	5 h
$35\text{ °C} \leq T_{BM} < 39\text{ °C}$	12 min	2 h	4,5 h
$T_{BM} = 40\text{ °C}$	10 min	2 h	4 h

1) The curing time data are valid for dry base material only. In wet base material the curing times must be doubled.

### Setting information

#### Installation equipment

Rebar – size	φ8	φ10	φ12	φ14	φ16	φ18	φ20	φ25	φ28	φ32	φ34	φ36	φ40
Rotary hammer	TE 2 (-A)– TE 40(-A)						TE40 – TE80						
	Blow out pump ( $h_{ef} \leq 10 \cdot d$ )						-						
Other tools	Compressed air gun <sup>a)</sup> Set of cleaning brushes <sup>b)</sup> , dispenser, piston plug Roughening tools												

a) Compressed air gun with extension hose for all drill holes deeper than 250 mm (for φ 8 to φ 12) or deeper than  $20 \cdot \phi$  (for φ > 12 mm)

b) Automatic brushing with round brush for all drill holes deeper than 250 mm (for φ 8 to φ 12) or deeper than  $20 \cdot \phi$  (for φ > 12 mm).

### Minimum concrete cover $c_{min}$ of the post-installed rebar

Drilling method	Bar diameter [mm]	Minimum concrete cover $c_{min}$ [mm]	
		Without drilling aid	With drilling aid
Hammer drilling (HD) and (HDB)	φ < 25	$30 + 0,06 \cdot l_v \geq 2 \cdot \phi$	$30 + 0,02 \cdot l_v \geq 2 \cdot \phi$
	φ ≥ 25	$40 + 0,06 \cdot l_v \geq 2 \cdot \phi$	$40 + 0,02 \cdot l_v \geq 2 \cdot \phi$
Compressed air drilling (CA)	φ < 25	$50 + 0,08 \cdot l_v$	$50 + 0,02 \cdot l_v$
	φ ≥ 25	$60 + 0,08 \cdot l_v \geq 2 \cdot \phi$	$60 + 0,02 \cdot l_v \geq 2 \cdot \phi$
Diamond coring in wet (PCC) dry (DD)	φ < 25	Drill stand works like a drilling aid	$30 + 0,02 \cdot l_v \geq 2 \cdot \phi$
	φ ≥ 25		$40 + 0,02 \cdot l_v \geq 2 \cdot \phi$
Diamond coring with Roughening too	φ < 25	$30 + 0,06 \cdot l_v \geq 2 \cdot \phi$	$30 + 0,02 \cdot l_v \geq 2 \cdot \phi$
	φ ≥ 25	$40 + 0,06 \cdot l_v \geq 2 \cdot \phi$	$40 + 0,02 \cdot l_v \geq 2 \cdot \phi$

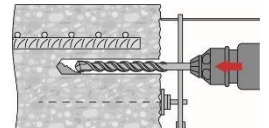

**Dispenser and corresponding maximum embedment depth  $l_{v,max}$** 

Rebar – size [mm]	HDM 330, HDM 500	HDE 500
	$l_{v,max}$ [mm]	
φ8	1000	1000
φ10	1000	1000
φ12	1000	1200
φ14	1000	1400
φ16	1000	1600
φ18	700	1800
φ20	600	2000
φ22	500	1800
φ24	300	1300
φ25	300	1500
φ26	300	1000
φ28	300	1000
φ30	-	1000
φ32		700
φ34		600
φ36		600
φ40		400

**Drilling diameters**

Rebar - size	Hammer drill (HD)	Hollow Drill Bit (HDB) <sup>b)</sup>	Compressed air drill (CA)	Diamond coring		
				Dry (PCC) <sup>b)</sup>	Wet (DD)	With roughening tool (RT) <sup>b)</sup>
$d_0$ [mm]						
φ8	12 (10 <sup>a)</sup> )	-	-	-	12 (10 <sup>a)</sup> )	-
φ10	14 (12 <sup>a)</sup> )	14 (12 <sup>a)</sup> )	-	-	14 (12 <sup>a)</sup> )	-
φ12	16 (14 <sup>a)</sup> )	16 (14 <sup>a)</sup> )	17	-	16 (14 <sup>a)</sup> )	-
φ14	18	18	17	-	18	18
φ16	20	20	20	-	20	20
φ18	22	22	22	-	22	22
φ20	25	25	26	-	25	25
φ22	28	28	28	-	28	28
φ24	32 (30 <sup>a)</sup> )	32 (30 <sup>a)</sup> )	32	-	32	32
φ25	32 (30 <sup>a)</sup> )	32 (30 <sup>a)</sup> )	32	-	32	32
φ26	35	35	35	35	35	35
φ28	35	35	35	35	35	35
φ30	37	-	37	35	37	-
φ32	40	-	40	47	40	-
φ34	45	-	42	47	45	-
φ36	45	-	45	47	47	-
φ40	55	-	57	52	52	-

a) Each of two given values can be used.

b) No cleaning required.

**Associated components for the use of Hilti Roughening tool TE-YRT**

Diamond coring		Roughening tool TE-YRT	Wear gauge RTG...
$d_0$ [mm]		$d_0$ [mm]	size
Nominal	measured		
18	17,9 to 18,2	18	18
20	19,9 to 20,2	20	20
22	21,9 to 22,2	22	22
25	24,9 to 25,2	25	25
28	27,9 to 28,2	28	28
30	29,9 to 30,2	30	30
32	31,9 to 32,2	32	32
35	34,9 to 35,2	35	35

**Minimum roughening time  $t_{roughen}$  ( $t_{roughen}$  [sec] =  $h_{ef}$  [mm] / 10)**

$h_{ef}$ [mm]	$t_{roughen}$ [sec]
0 to 100	10
101 to 200	20
201 to 300	30
301 to 400	40
401 to 500	50
501 to 600	60

**Setting instructions**

\*For detailed information on installation see instruction for use given with the package of the product.



**Safety regulations.**

Review the Material Safety Data Sheet (MSDS) before use for proper and safe handling! Wear well-fitting protective goggles and protective gloves when working with Hilti HIT-RE 500 V3.

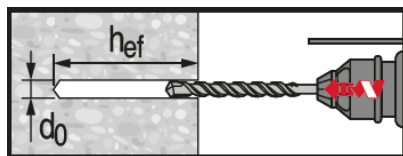

**Hammer drilled hole (HD)**

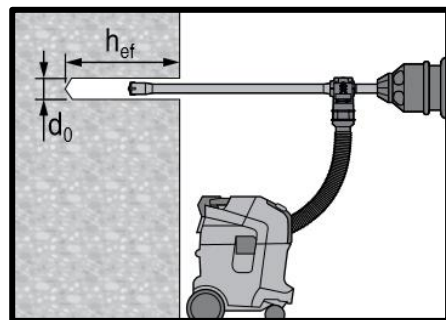

**Hammer drilled hole with Hollow Drilled Bit (HDB)**

No cleaning required

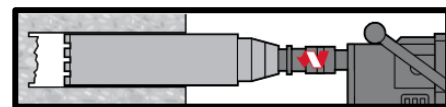

**Diamond Drilling (DD)**

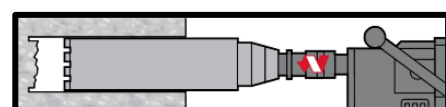

**Diamond Drilling + Roughening Tool (DD+RT)**

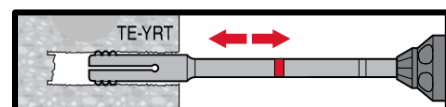

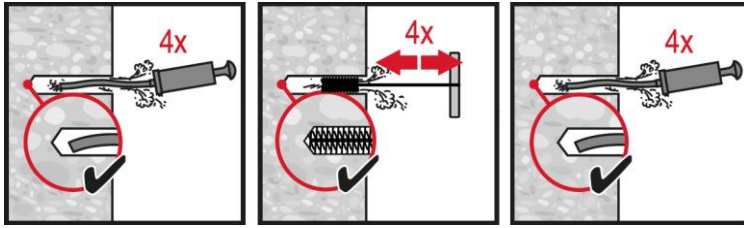

**Hammer Drilling:**

**Manual cleaning (MC)**

for drill diameters  $d_0 \leq 20$  mm and drill hole depth  $h_0 \leq 10 \cdot d$ .

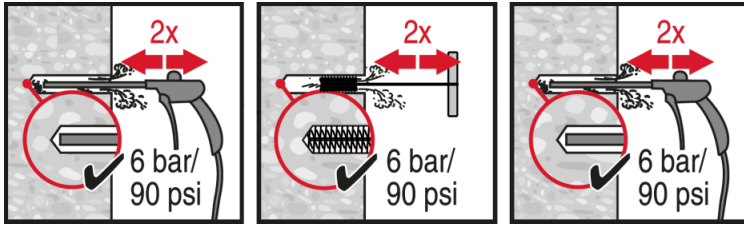

**Hammer Drilling:**

**Compressed air cleaning (CAC)**

for all drill hole diameters  $d_0$  and drill hole depths  $h_0 \leq 20 \cdot d$ .

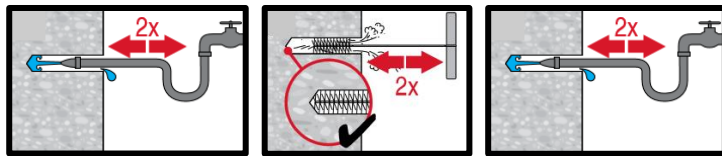

**Diamond cored holes:**

**Compressed air cleaning (CAC)**

for all drill hole diameters  $d_0$  and drill hole depths  $h_0$ .

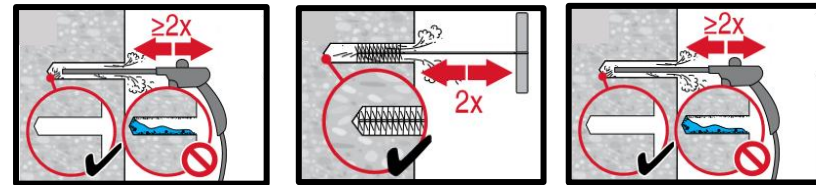

**Diamond cored holes with Hilti roughening tool:**

**Compressed air cleaning (CAC)**

for all drill hole diameters  $d_0$  and drill hole depths  $h_0$ .

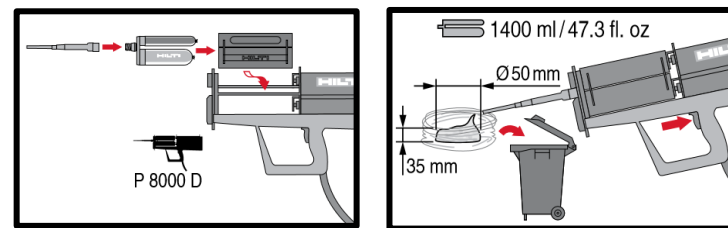
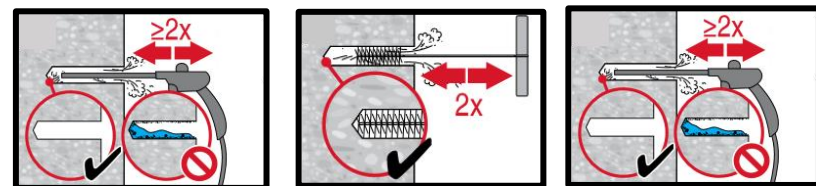

**Injection system preparation.**

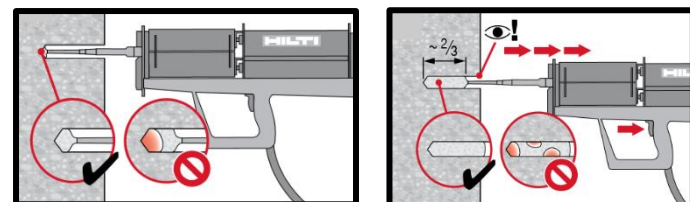

**Injection method for drill hole depth**

$h_{ef} \leq 250$  mm.

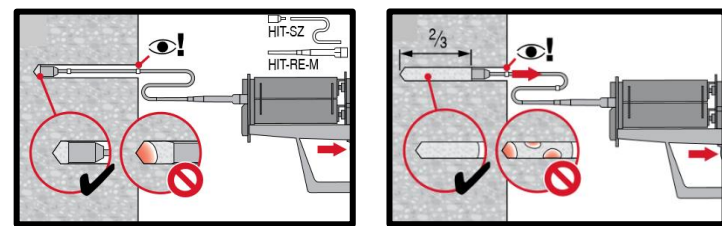

**Injection method for drill hole depth**

$h_{ef} > 250$  mm.



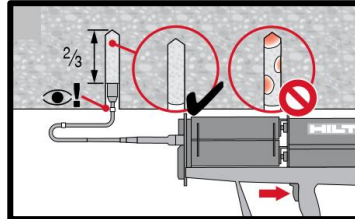
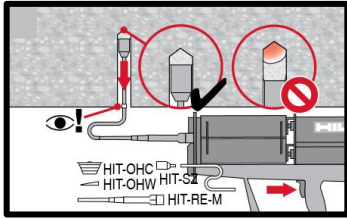

**Injection method** for overhead application.

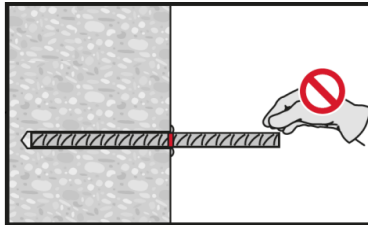
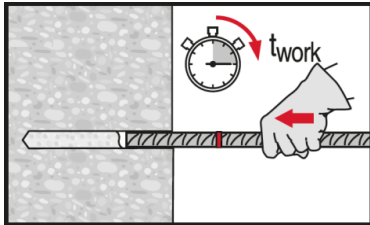

**Setting element**, observe working time " $t_{work}$ ".

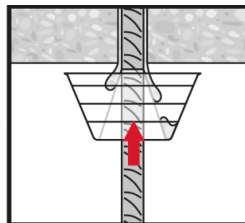
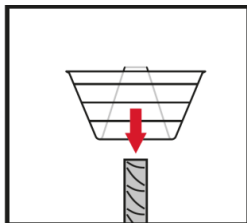
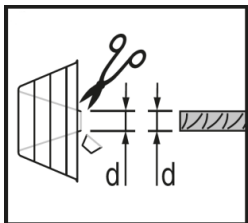

**Setting element** for overhead applications, observe working time " $t_{work}$ ".

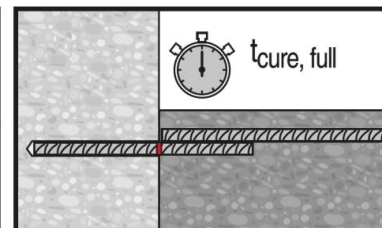
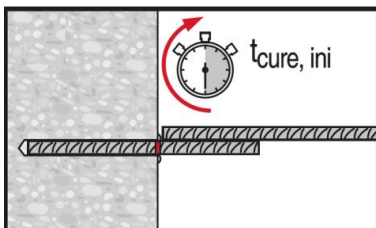
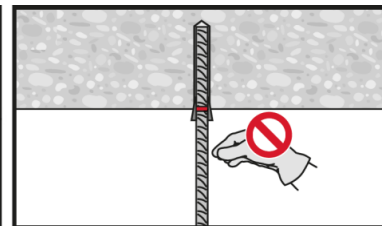
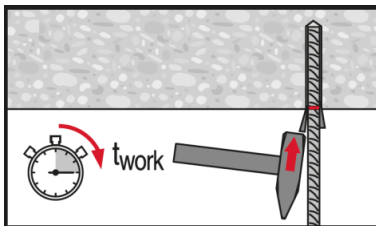

Apply full load only after curing time " $t_{cure}$ ".

# HIT-HY 200 injection mortar

Anchor design (EN 1992-4) / Rods&Sleeves / Concrete

Concrete

Chemical anchors

Mechanical anchors

Plastic/Light duty metal anchors

Insulation anchors

## Injection mortar system

## Benefits



Hilti HIT- HY 200-A

500 ml foil pack  
(also available as  
330 ml foil pack)



Hilti HIT- HY 200-R

500 ml foil pack  
(also available as  
330 ml foil pack)



Anchor rod:  
HAS-U  
HAS-U HDG  
HAS-U A4  
HAS-U HCR  
(M8-M30)



Internally threaded  
sleeve:  
HIS-N  
HIS-RN  
(M8-M20)



Anchor rod:  
HIT-Z  
HIT-Z-F  
HIT-Z-R  
(M8-M20)

- **SafeSet** technology: Simplified method of borehole preparation using either Hilti hollow drill bit for hammer drilling or Roughening tool for diamond cored applications
- Suitable for non-cracked and cracked concrete C 20/25 to C 50/60
- ETA Approved for seismic performance category C1, C2<sup>a)</sup>
- Maximum load performance in cracked concrete and non-cracked concrete
- High corrosion / corrosion resistance<sup>b)</sup>
- Small edge distance and anchor spacing possible
- Manual cleaning for borehole diameter up to 20mm and  $h_{ef} \leq 10d$  for non-cracked concrete only
- Two mortar versions: HY 200-R for slow cure applications and HY 200-A for fast cure applications

a) HIS-N internally threaded sleeves not approved for Seismic.

b) High Corrosion resistant rods available only for HAS-U. Corrosion resistant rods available for HAS-U and HIS-N

## Base material

## Installation conditions



Concrete (non-cracked)



Concrete (cracked)

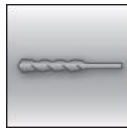

Hammer drilled holes



Diamond drilled holes <sup>c)</sup>

**SAFESET**

Hilti **SafeSet** technology

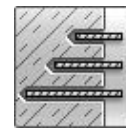

Variable embedment depth

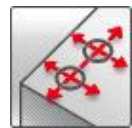

Small edge distance and spacing

## Load conditions

## Other information



Static/  
quasi-static



Seismic,  
ETA-C1, C2<sup>a)</sup>



Fire  
resistance



European  
Technical  
Assessment



CE  
conformity

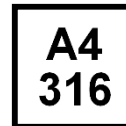

Corrosion  
resistance<sup>b)</sup>



High  
corrosion  
resistance<sup>b)</sup>



PROFIS  
Anchor design  
Software

a) HIS-N internally threaded sleeves not approved for Seismic category C2.

b) High Corrosion resistant rods available only for HAS-U. Corrosion resistant rods available for HAS-U and HIS-N.

c) Diamond drilling covered for HIT-Z rods. Diamond drilling only with Roughening Tool (RT) for HAS-U and HIS-N.



### Approvals / certificates

Description	Product	Authority / Laboratory	No. / date of issue
European Technical Assessment <sup>a)</sup>	HY 200-A	DIBt, Berlin	ETA-11/0493 / 2019-08-30
European Technical Assessment <sup>a)</sup>	HY 200-A	DIBt, Berlin	ETA-12/0006 / 2019-04-11
European Technical Assessment <sup>a)</sup>	HY 200-A	DIBt, Berlin	ETA-11/0492 / 2014-06-26
European Technical Assessment <sup>a)</sup>	HY 200-R	DIBt, Berlin	ETA-12/0084 / 2019-08-28
European Technical Assessment <sup>a)</sup>	HY 200-R	DIBt, Berlin	ETA-12/0028 / 2019-04-11
European Technical Assessment <sup>a)</sup>	HY 200-R	DIBt, Berlin	ETA-12/0083 / 2019-06-21
Shockproof fastenings in civil defence installations	HY 200-A/R	Federal Office for Civil Protection, Bern	BZS D 13-604 / 2013-12-31 BZS D 13-603 / 2013-12-31
Fire test report	HY 200-A/R	IBMB, Brunswick	3502/676/12 / 2017-09-15

a) All data given in this section according to the ETA approval for the product.

### Static and quasi-static resistance (for a single anchor)

#### All data in this section applies to:

- Correct setting (See setting instruction)
- No edge distance and spacing influence
- Steel failure
- Minimum base material thickness
- One typical embedment depth, as specified in the table
- One anchor material, as specified in the tables
- Concrete C 20/25,  $f_{ck,cube} = 25 \text{ N/mm}^2$
- Temperature range I (min. base material temp.  $-40^\circ\text{C}$ , max. long/short term base material temp.:  $+24^\circ\text{C}/40^\circ\text{C}$ )
- Short term loading. For long term loading please apply  $\psi_{sus}$ .  
Hammer drilled holes and Hammer drilled holes with Hollow Drill Bit:  $\psi_{sus} = 1.00$   
Diamond cored holes:  $\psi_{sus} = 0.78$

#### For hammer drilled holes, hammer drilled holes with Hilti hollow drill bit:

#### Anchorage depth <sup>1)</sup>

Anchor size		M8	M10	M12	M16	M20	M24	M27	M30
<b>HAS-U</b>									
Embedment depth	[mm]	80	90	110	125	170	210	240	270
Base material thickness	[mm]	110	120	140	160	220	270	300	340
<b>HIS-N</b>									
Embedment depth	[mm]	90	110	125	170	205	-	-	-
Base material thickness	[mm]	120	150	170	230	270	-	-	-
<b>HIT-Z</b>									
Effective anchorage depth <sup>2)</sup> $h_{ef}=l_{Helix}$	[mm]	50	60	60	96	100	-	-	-
Effective embedment depth <sup>3)</sup> $h_{ef}=h_{nom,min}$	[mm]	70	90	110	145	180	-	-	-
Base material thickness	[mm]	130	150	170	245	280	-	-	-

1) The allowed range of embedment depth is shown in the setting details.

2) For combined pull-out and concrete cone failure

3) For concrete cone failure

a) Hilti anchor rod HIT-Z-F: M16 and M20

**Characteristic resistance**

Anchor size		M8	M10	M12	M16	M20	M24	M27	M30
<b>Non-cracked concrete</b>									
Tension $N_{Rk}$	HAS-U 5.8	18,0	29,0	42,0	68,7	109	150	183	218
	HAS-U 8.8	29,0	42,0	56,8	68,7	109	150	183	218
	HAS-U A4	26,0	41,0	56,8	68,7	109	150	183	218
	HAS-U HCR	29,0	42,0	56,8	68,7	109	150	183	218
	HIS-N 8.8	25,0	46,0	67,0	109	116	-	-	-
	HIT-Z <sup>a)</sup>	24,0	38,0	54,3	96,0	133	-	-	-
Shear $V_{Rk}$	HAS-U 5.8	9,0	15,0	21,0	39,0	61,0	88,0	115	140
	HAS-U 8.8	15,0	23,0	34,0	63,0	98,0	141	184	224
	HAS-U A4	13,0	20,0	30,0	55,0	86,0	124	115	140
	HAS-U HCR	15,0	23,0	34,0	63,0	98,0	124	161	196
	HIS-N 8.8	13,0	23,0	34,0	63,0	58,0	-	-	-
	HIT-Z <sup>a)</sup>	12,0	19,0	27,0	48,0	73,0	-	-	-
<b>Cracked concrete</b>									
Tension $N_{Rk}$	HAS-U 5.8	15,1	21,2	35,2	48,1	76,3	105	128	153
	HAS-U 8.8	15,1	21,2	35,2	48,1	76,3	105	128	153
	HAS-U A4	15,1	21,2	35,2	48,1	76,3	105	128	153
	HAS-U HCR	15,1	21,2	35,2	48,1	76,3	105	128	153
	HIS-N 8.8	24,7	39,7	48,1	76,3	101	-	-	-
	HIT-Z <sup>a)</sup>	22,5	32,9	44,4	67,2	93,0	-	-	-
Shear $V_{Rk}$	HAS-U 5.8	9,0	15,0	21,0	39,0	61,0	88,0	115	140
	HAS-U 8.8	15,0	23,0	34,0	63,0	98,0	141	184	224
	HAS-U A4	13,0	20,0	30,0	55,0	86,0	124	115	140
	HAS-U HCR	15,0	23,0	34,0	63,0	98,0	124	161	196
	HIS-N 8.8	13,0	23,0	34,0	63,0	58,0	-	-	-
	HIT-Z <sup>a)</sup>	12,0	19,0	27,0	48,0	73,0	-	-	-

a) Hilti anchor rod HIT-Z-F: M16 and M20

**Design resistance**

Anchor size		M8	M10	M12	M16	M20	M24	M27	M30
<b>Non-cracked concrete</b>									
Tension $N_{Rd}$	HAS-U 5.8	12,0	19,3	28,0	45,8	72,7	99,8	122	146
	HAS-U 8.8	19,3	28,0	37,8	45,8	72,7	99,8	122	146
	HAS-U A4	13,9	21,9	31,6	45,8	72,7	99,8	80,4	98,3
	HAS-U HCR	19,3	28,0	37,8	45,8	72,7	99,8	122	146
	HIS-N 8.8	16,7	30,7	44,7	72,7	77,3	-	-	-
	HIT-Z <sup>a)</sup>	16,0	25,3	36,2	57,3	79,2	-	-	-
Shear $V_{Rd}$	HAS-U 5.8	7,2	12,0	16,8	31,2	48,8	70,4	92,0	112
	HAS-U 8.8	12,0	18,4	27,2	50,4	78,4	113	147	179
	HAS-U A4	8,3	12,8	19,2	35,3	55,1	79,5	48,3	58,8
	HAS-U HCR	12,0	18,4	27,2	50,4	78,4	70,9	92,0	112
	HIS-N 8.8	10,4	18,4	27,2	50,4	46,4	-	-	-
	HIT-Z <sup>a)</sup>	9,6	15,2	21,6	38,4	58,4	-	-	-
<b>Cracked concrete</b>									
Tension $N_{Rd}$	HAS-U 5.8	10,1	14,1	23,5	32,1	50,9	69,9	85,4	102
	HAS-U 8.8	10,1	14,1	23,5	32,1	50,9	69,9	85,4	102
	HAS-U A4	10,1	14,1	23,5	32,1	50,9	69,9	80,4	98,3
	HAS-U HCR	10,1	14,1	23,5	32,1	50,9	69,9	85,4	102
	HIS-N 8.8	16,5	26,5	32,1	50,9	67,4	-	-	-
	HIT-Z <sup>a)</sup>	13,4	19,6	26,5	40,1	55,4	-	-	-
Shear $V_{Rd}$	HAS-U 5.8	7,2	12,0	16,8	31,2	48,8	70,4	92,0	112
	HAS-U 8.8	12,0	18,4	27,2	50,4	78,4	113	147	179
	HAS-U A4	8,3	12,8	19,2	35,3	55,1	79,5	48,3	58,8
	HAS-U HCR	12,0	18,4	27,2	50,4	78,4	70,9	92,0	112
	HIS-N 8.8	10,4	18,4	27,2	50,4	46,4	-	-	-
	HIT-Z <sup>a)</sup>	9,6	15,2	21,6	38,4	58,4	-	-	-

a) Hilti anchor rod HIT-Z-F: M16 and M20

## Seismic resistance (for a single anchor)

### All data in this section applies to:

- Correct setting (See setting instruction with hammer drilling)
- No edge distance and spacing influence
- **Steel** failure
- Minimum base material thickness
- Concrete C 20/25,  $f_{ck,cube} = 25 \text{ N/mm}^2$
- Temperature range I (min. base material temp.  $-40^\circ\text{C}$ , max. long/short term base material temp.:  $+24^\circ\text{C}/40^\circ\text{C}$ )
- Installation temperature range  $-10^\circ\text{C}$  to  $+40^\circ\text{C}$
- $\alpha_{gap} = 1,0$  (using Hilti seismic filling set)

### For hammer drilled holes and hammer drilled holes with Hilti hollow drill bit:

#### Anchorage depth for seismic C2

Anchor size		M8	M10	M12	M16	M20	M24	M27	M30
<b>HAS-U</b>									
Embedment depth	$h_{ef}$ [mm]	-	-	-	125	170	210	-	-
<b>HIT-Z</b>									
Effective anchorage depth <sup>2)</sup>	$h_{ef} = l_{Helix}$ [mm]	-	-	60	96	100	-	-	-
Effective embedment depth <sup>3)</sup>	$h_{ef}$ [mm]	-	-	60	96	100	-	-	-
Base material thickness	[mm]	-	-	140	180	225	-	-	-

2) For combined pull-out and concrete cone failure

3) For concrete cone failure

#### Characteristic resistance in case of seismic performance category C2

Anchor size		M8	M10	M12	M16	M20	M24	M27	M30
Tension $N_{Rk,seis}$	HAS-U 8.8 [kN]	-	-	-	24,5	45,9	55,4	-	-
	HIT-Z <sup>a)</sup>	-	-	29,4	57,1	79,0	-	-	-
Shear $V_{Rk,seis}$	HAS-U 8.8 w/ filling set [kN]	-	-	-	46,0	77,0	103	-	-
	HAS-U 8.8 w/o filling set	-	-	-	40,0	71,0	90,0	-	-
	HIT-Z <sup>a)</sup> w/ filling set	-	-	23,0	41,0	61,0	-	-	-

a) Hilti anchor rod HIT-Z-F: M16 and M20

#### Design resistance in case of seismic performance category C2

Anchor size		M8	M10	M12	M16	M20	M24	M27	M30
Tension $N_{Rd,seis}$	HAS-U 8.8 [kN]	-	-	-	16,3	30,6	36,9	-	-
	HIT-Z <sup>a)</sup>	-	-	19,6	38,1	52,7	-	-	-
Shear $V_{Rd,seis}$	HAS-U 8.8 w/ filling set [kN]	-	-	-	36,8	61,6	82,4	-	-
	HAS-U 8.8 w/o filling set	-	-	-	32,0	56,8	72,0	-	-
	HIT-Z <sup>a)</sup> w/ filling set	-	-	18,4	32,8	48,8	-	-	-

a) Hilti anchor rod HIT-Z-F: M16 and M20

#### Anchorage depth for seismic C1

Anchor size		M8	M10	M12	M16	M20	M24	M27	M30
<b>HAS-U</b>									
Embedment depth	$h_{ef}$ [mm]	-	90	110	125	170	210	240	270
<b>HIT-Z</b>									
Effective anchorage depth <sup>1)</sup>	$h_{ef} = l_{Helix}$ [mm]	50	60	60	96	100	-	-	-
Effective embedment depth <sup>2)</sup>	$h_{ef}$ [mm]	50	60	60	96	100	-	-	-
Base material thickness	[mm]	100	120	140	180	225	-	-	-

1) For combined pull-out and concrete cone failure

2) For concrete cone failure

**Characteristic resistance in case of seismic performance category C1**

Anchor size		M8	M10	M12	M16	M20	M24	M27	M30
Tension $N_{Rk,seis}$	HAS-U 8.8	-	14,7	29,0	44,0	72,5	99,6	122	145
	HIT-Z <sup>a)</sup> ; HIT-Z-R	19,2	27,9	37,8	57,1	79,0	-	-	-
Shear $V_{Rk,seis}$	HAS-U 8.8	-	23,0	34,0	63,0	98,0	141	184	224
	HIT-Z <sup>a)</sup> ; HIT-Z-R	7,0	17,0	16,0	28,0	45,0	-	-	-

a) Hilti anchor rod HIT-Z-F: M16 and M20

**Design resistance in case of seismic performance category C1**

Anchor size		M8	M10	M12	M16	M20	M24	M27	M30
Tension $N_{Rd,seis}$	HAS-U 8.8	-	9,8	19,4	29,3	48,4	66,4	81,1	96,8
	HIT-Z <sup>a)</sup> ; HIT-Z-R	12,8	18,6	25,2	38,1	52,7	-	-	-
Shear $V_{Rd,seis}$	HAS-U 8.8	-	18,4	27,2	50,4	78,4	113	145	173
	HIT-Z <sup>a)</sup> ; HIT-Z-R	5,6	13,6	12,8	22,4	36,0	-	-	-

a) Hilti anchor rod HIT-Z-F: M16 and M20

**Materials**
**Mechanical properties for HAS-U**

Anchor size		M8	M10	M12	M16	M20	M24	M27	M30
Nominal tensile strength $f_{uk}$	HAS-U 5.8 (HDG)	500	500	500	500	500	500	-	-
	HAS-U 8.8 (HDG)	800	800	800	800	800	800	800	800
	AM 8.8 (HDG)								
	HAS-U A4	700	700	700	700	700	700	500	500
HAS-U HCR	800	800	800	800	800	700	-	-	
Yield strength $f_{yk}$	HAS-U 5.8 (HDG)	440	440	440	440	400	400	-	-
	HAS-U 8.8 (HDG)	640	640	640	640	640	640	640	640
	AM 8.8 (HDG)								
	HAS-U A4	450	450	450	450	450	450	210	210
HAS-U HCR	640	640	640	640	640	400	-	-	
Stressed cross-section $A_s$	HAS-U	36,6	58,0	84,3	157	245	353	459	561
Moment of resistance $W$	HAS-U	31,2	62,3	109	277	541	935	1387	1874

**Mechanical properties for HIS-N**

Anchor size		M8	M10	M12	M16	M20
Nominal tensile strength $f_{uk}$	HIS-N	490	490	490	490	490
	Screw 8.8	800	800	800	800	800
	HIS-RN	700	700	700	700	700
	Screw A4-70	700	700	700	700	700
Yield strength $f_{yk}$	HIS-N	390	390	390	390	390
	Screw 8.8	640	640	640	640	640
	HIS-RN	350	350	350	350	350
	Screw A4-70	450	450	450	450	450
Stressed cross-section $A_s$	HIS-(R)N	51,5	108	169	256	238
	Screw	36,6	58,0	84,3	157	245
Moment of resistance $W$	HIS-(R)N	145	430	840	1595	1543
	Screw	31,2	62,3	109	277	541

### Mechanical properties for HIT-Z

Anchor size		M8	M10	M12	M16	M20
Nominal tensile strength $f_{uk}$	HIT-Z(-F) <sup>a)</sup>	650	650	650	610	595
	HIT-Z-R	650	650	650	610	595
Yield strength $f_{yk}$	HIT-Z(-F) <sup>a)</sup>	520	520	520	490	480
	HIT-Z-R	520	520	520	490	480
Stressed cross-section of thread $A_s$	HIT-Z(-F) <sup>a)</sup> HIT-Z-R	36,6	58,0	84,3	157	245
Moment of resistance W	HIT-Z(-F) <sup>a)</sup> HIT-Z-R	31,9	62,5	109,7	278	542

a) Hilti anchor rod HIT-Z-F: M16 and M20

### Material quality for HAS-U

Part	Material
<b>Zinc coated steel</b>	
Threaded rod, HAS-U 5.8 (HDG)	Strength class 5.8; Elongation at fracture A5 > 8% ductile Electroplated zinc coated $\geq 5\mu\text{m}$ ; (HDG) hot dip galvanized $\geq 45\mu\text{m}$
Threaded rod, HAS-U 8.8 (HDG)	Strength class 8.8; Elongation at fracture A5 > 12% ductile Electroplated zinc coated $\geq 5\mu\text{m}$ ; (HDG) hot dip galvanized $\geq 45\mu\text{m}$
Hilti Meter rod, AM 8.8 (HDG)	Strength class 8.8; Elongation at fracture A5 > 12% ductile Electroplated zinc coated $\geq 5\mu\text{m}$ (HDG) hot dip galvanized $\geq 45\mu\text{m}$
Washer	Electroplated zinc coated $\geq 5\mu\text{m}$ , hot dip galvanized $\geq 45\mu\text{m}$
Nut	Strength class of nut adapted to strength class of threaded rod. Electroplated zinc coated $\geq 5\mu\text{m}$ , (HDG) hot dip galvanized $\geq 45\mu\text{m}$
Hilti Filling set (F)	Filling washer: Electroplated zinc coated $\geq 5\mu\text{m}$ / (HDG) Hot dip galvanized $\geq 45\mu\text{m}$
	Spherical washer: Electroplated zinc coated $\geq 5\mu\text{m}$ / (HDG) Hot dip galvanized $\geq 45\mu\text{m}$
	Lock nut: Electroplated zinc coated $\geq 5\mu\text{m}$ / (HDG) Hot dip galvanized $\geq 45\mu\text{m}$
<b>Stainless Steel</b>	
Threaded rod, HAS-U A4	Strength class 70 for $\leq M24$ and strength class 50 for $> M24$ ; Elongation at fracture A5 > 8% ductile Stainless steel 1.4401; 1.4404; 1.4578; 1.4571; 1.4439; 1.4362 EN 10088-1:2014
Washer	Stainless steel 1.4401, 1.4404, 1.4578, 1.4571, 1.4439, 1.4362 EN 10088-1:2014
Nut	Stainless steel 1.4401, 1.4404, 1.4578, 1.4571, 1.4439, 1.4362 EN 10088-1:2014
<b>High corrosion resistant steel</b>	
Threaded rod, HAS-U HCR	Strength class 80 for $\leq M20$ and class 70 for $> M20$ , Elongation at fracture A5 > 8% ductile High corrosion resistant steel 1.4529, 1.4565 EN 10088-1:2014
Washer	High corrosion resistant steel 1.4529, 1.4565 EN 10088-1:2014
Nut	High corrosion resistant steel 1.4529, 1.4565 EN 10088-1:2014

### Material quality for HIS-N

Part	Material	
HIS-N	Int. threaded sleeve	Electroplated zinc coated $\geq 5\mu\text{m}$
	Screw 8.8	Strength class 8.8, A5 > 8 % Ductile; Steel galvanized $\geq 5\mu\text{m}$
HIS-RN	Int. threaded sleeve	Stainless steel 1.4401, 1.4571 EN 10088-1:2014
	Screw 70	Strength class 70, A5 > 8 % Ductile; Stainless steel 1.4401; 1.4404, 1.4578; 1.4571; 1.4439; 1.4362

### Material quality for HIT-Z

Part	Material
Threaded rod HIT-Z	Elongation at fracture > 8% ductile; Electroplated zinc coated $\geq 5 \mu\text{m}$
Washer	Electroplated zinc coated $\geq 5 \mu\text{m}$
Nut	Strength class of nut adapted to strength class of anchor rod. Electroplated zinc coated $\geq 5 \mu\text{m}$
HIT-Z-F	Elongation at fracture > 8% ductile Multilayer coating, ZnNi-galvanized according to DIN 50979:2008-07
Washer	Multilayer coating, ZnNi-galvanized according to DIN 50979:2008-07
Nut	Multilayer coating, ZnNi-galvanized according to DIN 50979:2008-07
HIT-Z-R	Elongation at fracture > 8% ductile; Stainless steel 1.4401, 1.4404 EN 10088-1:2014
Washer	Stainless steel A4 according to EN 10088-1:2014
Nut	Strength class of nut adapted to strength class of anchor rod. Stainless steel 1.4401, 1.4404 EN 10088-1:2014

### Setting information

#### In service temperature range

Hilti HIT-HY 200 A (R) injection mortar with anchor rod HAS-U / HIS-(R)N may be applied in the temperature ranges given below. An elevated base material temperature leads to a reduction of the design bond resistance.

#### Temperature in the base material

Temperature range	Base material temperature	Maximum long term base material temperature	Maximum short term base material temperature
Temperature range I	-40 °C to +40 °C	+24 °C	+40 °C
Temperature range II	-40 °C to +80 °C	+50 °C	+80 °C
Temperature range III	-40 °C to +120 °C	+72 °C	+120 °C

#### Max short term base material temperature

Short-term elevated base material temperatures are those that occur over brief intervals, e.g. as a result of diurnal cycling.

#### Max long term base material temperature

Long-term elevated base material temperatures are roughly constant over significant periods of time.

### Curing and working time

Temperature of the base material	HIT-HY 200-A		HIT-HY 200-R	
	Maximum working time $t_{\text{work}}$	Minimum curing time $t_{\text{cure}}$	Maximum working time $t_{\text{work}}$	Minimum curing time $t_{\text{cure}}$
$-10^{\circ}\text{C} < T_{\text{BM}} \leq -5^{\circ}\text{C}$	1,5 h	7 h	3 h	20 h
$-5^{\circ}\text{C} < T_{\text{BM}} \leq 0^{\circ}\text{C}$	50 min	4 h	2 h	8 h
$0^{\circ}\text{C} < T_{\text{BM}} \leq 5^{\circ}\text{C}$	25 min	2 hour	1 h	4 h
$5^{\circ}\text{C} < T_{\text{BM}} \leq 10^{\circ}\text{C}$	15 min	75 min	40 min	2,5 h
$10^{\circ}\text{C} < T_{\text{BM}} \leq 20^{\circ}\text{C}$	7 min	45 min	15 min	1,5 h
$20^{\circ}\text{C} < T_{\text{BM}} \leq 30^{\circ}\text{C}$	4 min	30 min	9 min	1 h
$30^{\circ}\text{C} < T_{\text{BM}} \leq 40^{\circ}\text{C}$	3 min	30 min	6 min	1 h

### Setting details for HAS-U

Anchor size	M8	M10	M12	M16	M20	M24	M27	M30	
Nominal diameter of drill bit $d_0$ [mm]	10	12	14	18	22	28	30	35	
Eff. embedment depth and drill hole depth <sup>a)</sup>	$h_{ef,min}$ [mm]	60	60	70	80	90	96	108	120
	$h_{ef,max}$ [mm]	160	200	240	320	400	480	540	600
Minimum base material thickness	$h_{ef} + 30 \text{ mm} \geq 100 \text{ mm}$			$h_{ef} + 2 d_0$					
Maximum diameter of clearance hole in the fixture	$d_f$ [mm]	9	12	14	18	22	26	30	33
Thickness of Hilti filling set	$h_{fs}$ [mm]	-	-	-	11	13	15	-	-
Effective fixture thickness with Hilti filling set	$t_{fix,eff}$ [mm]	$t_{fix} - h_{fs}$							
Max. torque moment <sup>b)</sup>	$T_{max}$ [Nm]	10	20	40	80	150	200	270	300
Minimum spacing	$s_{min}$ [mm]	40	50	60	75	90	115	120	140
Minimum edge distance	$c_{min}$ [mm]	40	45	45	50	55	60	75	80
Critical spacing for splitting failure	$s_{cr,sp}$ [mm]	$2 C_{cr,sp}$							
Critical edge distance for splitting failure <sup>c)</sup>	$C_{cr,sp}$ [mm]	$1,0 \cdot h_{ef}$ for $h / h_{ef} \geq 2,00$							
		$4,6 h_{ef} - 1,8 h$ for $2,00 > h / h_{ef} > 1,3$							
		$2,26 h_{ef}$ for $h / h_{ef} \leq 1,3$							
Critical spacing for concrete cone failure	$s_{cr,N}$ [mm]	$2 C_{cr,sp}$							
Critical edge distance for concrete cone failure <sup>d)</sup>	$C_{cr,N}$ [mm]	$1,5 h_{ef}$							

For spacing (edge distance) smaller than critical spacing (critical edge distance) the design loads have to be reduced.

- a)  $h_{ef,min} \leq h_{ef} \leq h_{ef,max}$  ( $h_{ef}$ : embedment depth)
- b) Maximum recommended torque moment to avoid splitting failure during installation with minimum spacing and edge distance
- c)  $h$ : base material thickness ( $h \geq h_{min}$ )
- d) The critical edge distance for concrete cone failure depends on the embedment depth  $h_{ef}$  and the design bond resistance. The simplified formula given in this table is on the save side.

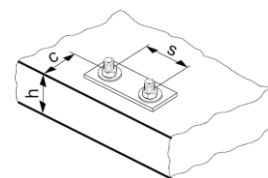

HAS-U-...



#### Marking:

Steel grade number and length identification letter: e.g. 8L



### Setting details for HIS-N

Anchor size		M8	M10	M12	M16	M20
Nominal diameter of drill bit $d_0$	[mm]	14	18	22	28	32
Diameter of element $d$	[mm]	12,5	16,5	20,5	25,4	27,6
Effective anchorage and drill hole depth $h_{ef}$	[mm]	90	110	125	170	205
Minimum base material thickness $h_{min}$	[mm]	120	150	170	230	270
Diameter of clearance hole in the fixture $d_f$	[mm]	9	12	14	18	22
Thread engagement length; min - max $h_s$	[mm]	8-20	10-25	12-30	16-40	20-50
Minimum spacing $s_{min}$	[mm]	60	75	90	115	130
Minimum edge distance $c_{min}$	[mm]	40	45	55	65	90
Critical spacing for splitting failure $s_{cr,sp}$	[mm]	$2 C_{cr,sp}$				
Critical edge distance for splitting failure <sup>b)</sup> $c_{cr,sp}$	[mm]	$1,0 \cdot h_{ef}$ for $h / h_{ef} \geq 2,0$				
		$4,6 h_{ef} - 1,8 h$ for $2,0 > h / h_{ef} > 1,3$				
		$2,26 h_{ef}$ for $h / h_{ef} \leq 1,3$				
Critical spacing for concrete cone failure $s_{cr,N}$	[mm]	$2 C_{cr,N}$				
Critical edge distance for concrete cone failure <sup>c)</sup> $c_{cr,N}$	[mm]	$1,5 h_{ef}$				
Max. torque moment <sup>a)</sup> $T_{max}$	[Nm]	10	20	40	80	150

For spacing (edge distance) smaller than critical spacing (critical edge distance) the design loads have to be reduced.

- a) Max. recommended torque moment to avoid splitting failure during installation with minimum spacing and edge distance
- b)  $h$ : base material thickness ( $h \geq h_{min}$ )
- c) The critical edge distance for concrete cone failure depends on the embedment depth  $h_{ef}$  and the design bond resistance. The simplified formula given in this table is on the safe side.

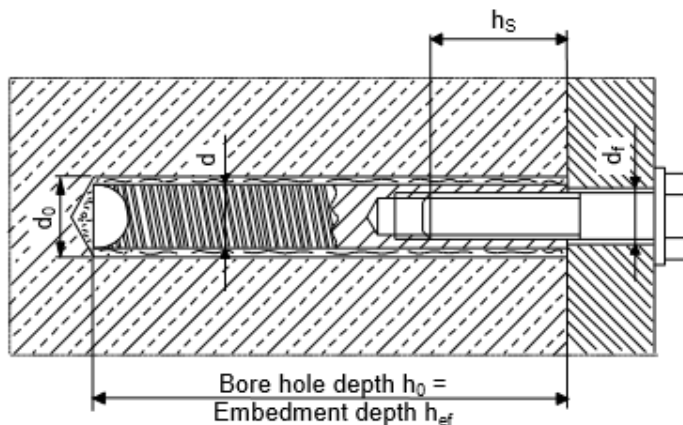
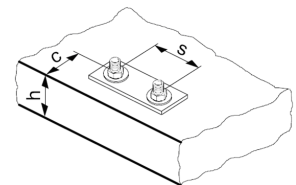

### Settings details HIT-Z, HIT-Z-F and HIT-Z-R

Anchor size		M8	M10	M12	M16	M20	
Nominal diameter of drill bit	$d_0$ [mm]	10	12	14	18	22	
Length of anchor	min l [mm]	80	95	105	155	215	
	max l [mm]	120	160	196	420	450	
Nominal embedment depth range <sup>a)</sup>	$h_{nom,min}$ [mm]	60	60	60	96	100	
	$h_{nom,max}$ [mm]	100	120	144	192	220	
Borehole condition 1 Min. base material thickness	$h_{min}$ [mm]	$h_{nom} + 60$ mm			$h_{nom} + 100$ mm		
Borehole condition 2 Min. base material thickness	$h_{min}$ [mm]	$h_{nom} + 30$ mm $\geq 100$ mm			$h_{nom} + 45$ mm $\geq 45$ mm		
Maximum depth of drill hole	$h_0$ [mm]	$h - 30$ mm			$h - 2 d_0$		
Pre-setting: Diameter of clearance hole in the fixture	$d_f$ [mm]	9	12	14	18	22	
Through-setting: Diameter of clearance hole in the fixture	$d_f$ [mm]	11	14	16	20	24	
Maximum fixture thickness	$t_{fix}$ [mm]	48	87	120	303	326	
Maximum fixture thickness with seismic filling set	$t_{fix}$ [mm]	41	79	111	292	314	
Installation torque moment <sup>b)</sup>	$T_{inst}$ [Nm]	10	25	40	80	150	
Critical spacing for splitting failure	$s_{cr,sp}$ [mm]	$2 C_{cr,sp}$					
Critical edge distance for splitting failure <sup>c)</sup>	$c_{cr,sp}$ [mm]	$1,5 \cdot h_{nom}$		for $h / h_{nom} \geq 2,35$			
		$6,2 h_{nom} - 2,0 h$					for $2,35 > h / h_{nom} > 1,35$
		$3,5 h_{nom}$		for $h / h_{nom} \leq 1,35$			
Critical spacing for concrete cone failure	$s_{cr,N}$ [mm]	$2 C_{cr,N}$					
Critical edge distance concrete cone failure <sup>d)</sup>	$c_{cr,N}$ [mm]	$1,5 h_{nom}$					

For spacing (edge distance) smaller than critical spacing (critical edge distance) the design loads have to be reduced.

- a)  $h_{nom,min} \leq h_{nom} \leq h_{nom,max}$  ( $h_{nom}$ : embedment depth)
- b) Recommended torque moment to avoid splitting failure during installation with minimum spacing and edge distance
- c)  $h$ : base material thickness ( $h \geq h_{min}$ )
- d) The critical edge distance for concrete cone failure depends on the embedment depth  $h_{ef}$  and the design bond resistance. The simplified formula given in this table is on the safe side.

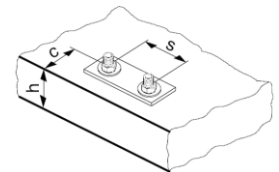

#### Pre-setting:

Install anchor before positioning fixture

#### Through-setting:

Install anchor through positioned fixture

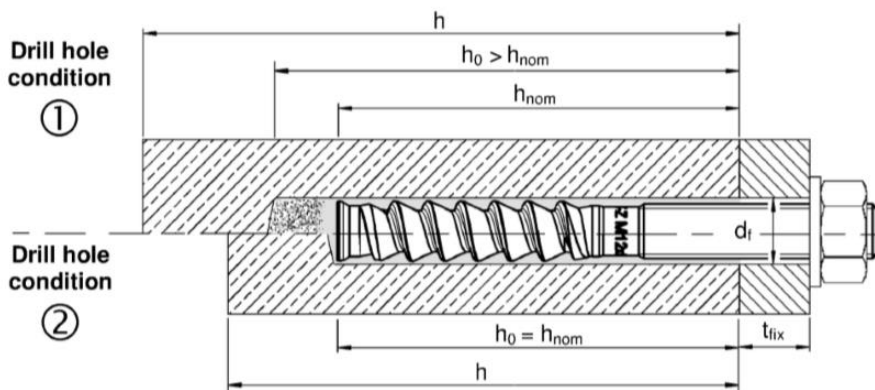

- Drill hole condition 1 → non-cleaned borehole
- Drill hole condition 2 → drilling dust is completely removed

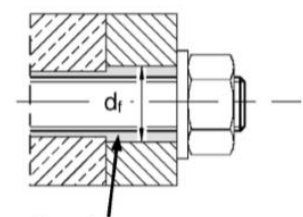

Annular gap filled with Hilti HIT-HY 200-A

### Anchor dimension for HIT-Z

Anchor size			M8	M10	M12	M16	M20
Length of anchor	min $l$	[mm]	80	95	105	155	215
	max $l$		120	160	196	420	450
Helix length	$l_{\text{Helix}}$	[mm]	50	60	60	96	100

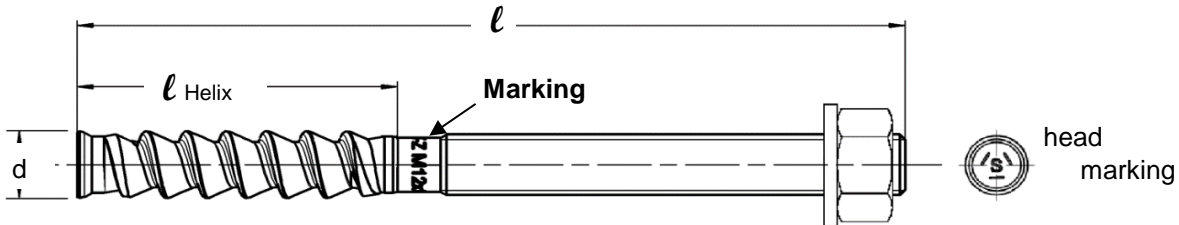

### Minimum edge distance and spacing for HIT-Z

For the calculation of minimum spacing and minimum edge distance of anchors in combination with different embedment depth and thickness of concrete member the following equation shall be fulfilled:  $A_{i, \text{req}} < A_{i, \text{cal}}$

### Required interaction area $A_{i, \text{cal}}$ for HIT-Z

Anchor size		M8	M10	M12	M16	M20
Cracked concrete	[mm <sup>2</sup> ]	19200	40800	58800	94700	148000
Non-cracked concrete	[mm <sup>2</sup> ]	22200	57400	80800	128000	198000

### Effective area $A_{i, \text{ef}}$ of HIT-Z

#### Member thickness $h \geq h_{\text{nom}} + 1,5 \cdot c$

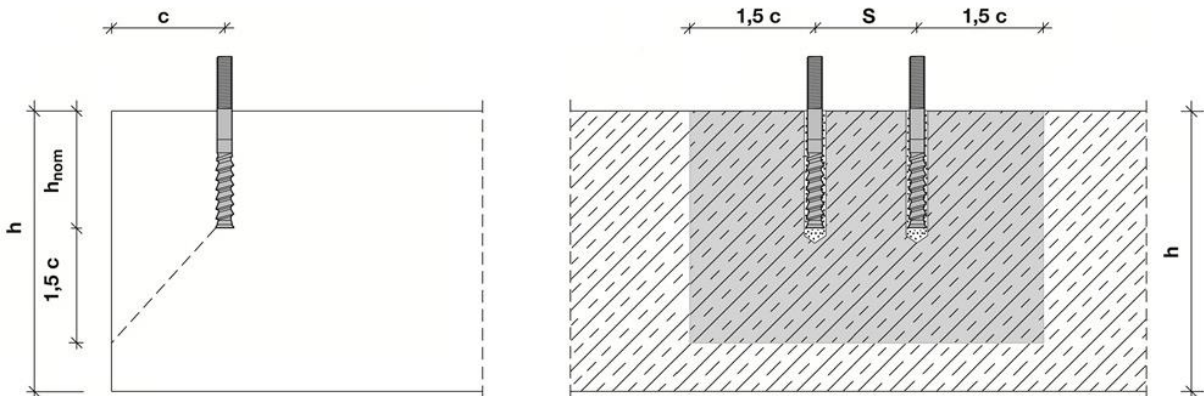

Single anchor and group of anchors with $s > 3 \cdot c$	[mm <sup>2</sup> ]	$A_{i, \text{cal}} = (6 \cdot c) \cdot (h_{\text{nom}} + 1,5 \cdot c)$	with $c \geq 5 \cdot d$
Group of anchors with $s \leq 3 \cdot c$	[mm <sup>2</sup> ]	$A_{i, \text{cal}} = (3 \cdot c + s) \cdot (h_{\text{nom}} + 1,5 \cdot c)$	with $c \geq 5 \cdot d$ and $s \geq 5 \cdot d$

#### Member thickness $h \leq h_{\text{nom}} + 1,5 \cdot c$

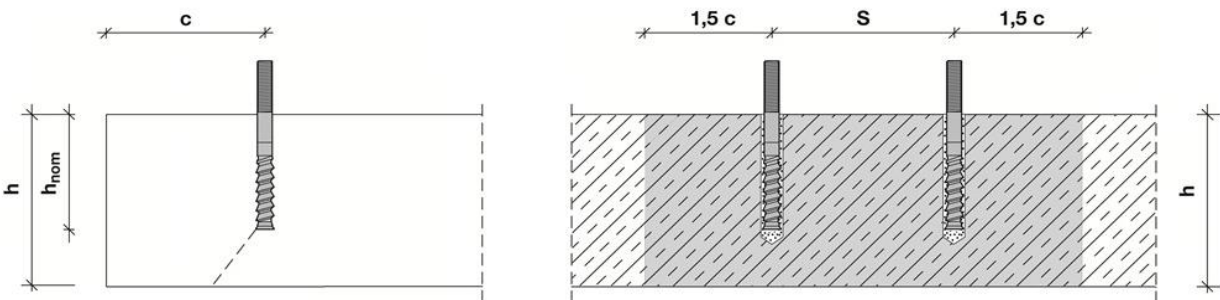

Single anchor and group of anchors with $s > 3 \cdot c$	[mm <sup>2</sup> ]	$A_{i, \text{cal}} = (6 \cdot c) \cdot h$	with $c \geq 5 \cdot d$
Group of anchors with $s \leq 3 \cdot c$	[mm <sup>2</sup> ]	$A_{i, \text{cal}} = (3 \cdot c + s) \cdot h$	with $c \geq 5 \cdot d$ and $s \geq 5 \cdot d$

**Best case minimum edge distance and spacing with required member thickness and embedment depth**

Anchor size		M8	M10	M12	M16	M20
<b>Cracked concrete</b>						
Member thickness	$h \geq$ [mm]	140	200	240	300	370
Embedment depth	$h_{nom} \geq$ [mm]	80	120	150	200	220
Minimum spacing	$s_{min}$ [mm]	40	50	60	80	100
Corresponding edge distance	$c \geq$ [mm]	40	55	65	80	100
Minimum edge distance	$c_{min} =$ [mm]	40	50	60	80	100
Corresponding spacing	$s \geq$ [mm]	40	60	65	80	100
<b>Non-cracked concrete</b>						
Member thickness	$h \geq$ [mm]	140	230	270	340	410
Embedment depth	$h_{nom} \geq$ [mm]	80	120	150	200	220
Minimum spacing	$s_{min}$ [mm]	40	50	60	80	100
Corresponding edge distance	$c \geq$ [mm]	40	70	80	100	130
Minimum edge distance	$c_{min}$ [mm]	40	50	60	80	100
Corresponding spacing	$s \geq$ [mm]	40	145	160	160	235

**Best case minimum member thickness and embedment depth with required minimum edge distance and spacing (borehole condition 1)**

Anchor size		M8	M10	M12	M16	M20
<b>Cracked concrete</b>						
Member thickness	$h \geq$ [mm]	120	120	120	196	200
Embedment depth	$h_{nom} \geq$ [mm]	60	60	60	96	100
Minimum spacing	$s_{min}$ [mm]	40	50	60	80	100
Corresponding edge distance	$c \geq$ [mm]	40	100	140	135	215
Minimum edge distance	$c_{min} =$ [mm]	40	60	90	80	125
Corresponding spacing	$s \geq$ [mm]	40	160	220	235	365
<b>Non cracked concrete</b>						
Member thickness	$h \geq$ [mm]	120	120	120	196	200
Embedment depth	$h_{nom} \geq$ [mm]	60	60	60	96	100
Minimum spacing	$s_{min}$ [mm]	40	50	60	80	100
Corresponding edge distance	$c \geq$ [mm]	50	145	200	190	300
Minimum edge distance	$c_{min}$ [mm]	40	80	115	110	165
Corresponding spacing	$s \geq$ [mm]	65	240	330	310	495

### Minimum edge distance and spacing – Explanation

Minimum edge and spacing geometrical requirements are determined by testing the installation conditions in which two anchors with a given spacing can be set close to an edge without forming a crack in the concrete due to tightening torque.

The HIT-Z boundary conditions for edge and spacing geometry can be found in the tables to the left. If the embedment depth and slab thickness are equal to or greater than the values in the table, then the edge and spacing values may be utilized.

**PROFIS Anchor software is programmed to calculate the referenced equations in order to determine the optimized related minimum edge and spacing based on the following variables:**

<b>Cracked or non-cracked concrete</b>	For cracked concrete it is assumed that a reinforcement is present which limits the crack width to 0,3 mm, allowing smaller values for minimum edge distance and minimum spacing
<b>Anchor diameter</b>	For smaller anchor diameter a smaller installation torque is required, allowing smaller values for minimum edge distance and minimum spacing
<b>Slab thickness and embedment depth</b>	Increasing these values allows smaller values for minimum edge distance and minimum spacing

### Installation equipment



Anchor size	M8	M10	M12	M16	M20	M24	M27	M30
Rotary hammer	HAS-U	TE 2 – TE 16			TE 40 - TE 80			
	HIT-Z	TE 2 – TE 40		TE 40 – TE 80		-		
	HIS-N	TE (-A) – TE 16(-A)		TE 40 – TE 80		-		
Other tools	compressed air gun and blow out pump, set of cleaning brushes, dispenser Hollow Drill Bit							
	roughening tools TE-YRT							
Additional Hilti recommended tools	DD EC-1, DD 100 ... DD 160 <sup>a)</sup>							

a) For anchors in diamond drilled holes load values for combined pull-out and concrete cone resistance have to be reduced

### Cleaning, drilling and installation parameters

HAS-U	HIT-Z	HIS-N	Drill bit diameters d <sub>0</sub> [mm]				Cleaning and installation	
			Hammer drill (HD)	Hollow Drill Bit (HDB)	Diamond coring		Brush HIT-RB	Piston plug HIT-SZ
					Diamond coring (DD)	With roughening tool (RT)		
<b>M8</b>	<b>M8</b>	-	10	-	10	-	10	-
<b>M10</b>	<b>M10</b>	-	12	12	12	-	12	12
<b>M12</b>	<b>M12</b>	<b>M8</b>	14	14	14	-	14	14
<b>M16</b>	<b>M16</b>	<b>M10</b>	18	18	18	18	18	18
<b>M20</b>	<b>M20</b>	<b>M12</b>	22	22	22	22	22	22
<b>M24</b>	-	<b>M16</b>	28	28	28	28	28	28
<b>M27</b>	-	-	30	-	30	30	30	30
-	-	<b>M20</b>	32	32	32	32	32	32
<b>M30</b>	-	-	35	35	35	35	35	35

**Associated components for the use of Hilti Roughening tool TE-YRT**

Diamond coring		Roughening tool TE-YRT	Wear gauge RTG...
			
do [mm]		do [mm]	size
Nominal	measured		
18	17,9 to 18,2	18	18
20	19,9 to 20,2	20	20
22	21,9 to 22,2	22	22
25	24,9 to 25,2	25	25
28	27,9 to 28,2	28	28
30	29,9 to 30,2	30	30
32	31,9 to 32,2	32	32
35	34,9 to 35,2	35	35

**Installation parameters for use of the Hilti Roughening tool TE-YRT**

h <sub>ef</sub> [mm]	Minimum roughening time t <sub>roughen</sub> [sec] (t <sub>roughen</sub> [sec] = h <sub>ef</sub> [mm] / 10)	Minimum blowing time t <sub>blowing</sub> [sec] (t <sub>blowing</sub> [sec] = t <sub>roughen</sub> [sec] + 20)
0 to 100	10	30
101 to 200	20	40
201 to 300	30	50
301 to 400	40	60
401 to 500	50	70
501 to 600	60	80



## Setting instructions for HAS-U rods and HIS-N internally threaded sleeves

\*For detailed information on installation see instruction for use given with the package of the product



### Safety regulations.

Review the Material Safety Data Sheet (MSDS) before use for proper and safe handling! Wear well-fitting protective goggles and protective gloves when working with Hilti HIT-HY 200 A (R).

### Drilling

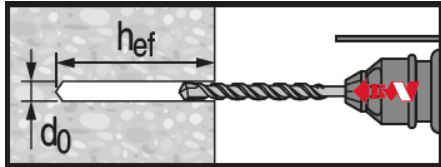

Hammer drilled hole (HD)

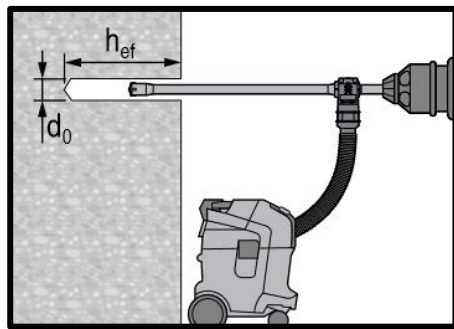

Hammer drilled hole with Hollow Drilled Bit (HDB)

No cleaning required

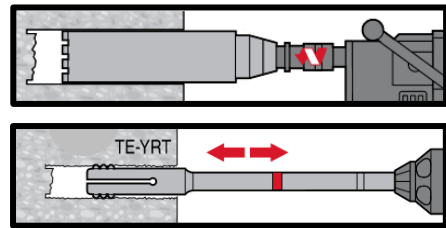

Diamond Drilling + Roughening Tool (DD+RT)

### Cleaning

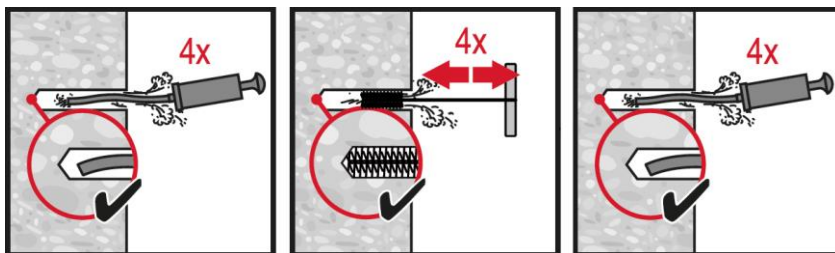

#### Hammer drilling:

#### Manual cleaning (MC)

for drill diameters  $d_0 \leq 20$  mm and drill hole depth  $h_0 \leq 10 \cdot d$ .

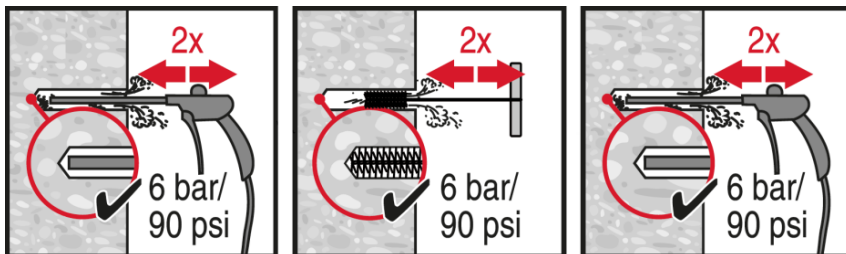

#### Hammer drilling:

#### Compressed air cleaning (CAC)

for all drill hole diameters  $d_0$  and drill hole depths  $h_0 \leq 20 \cdot d$ .

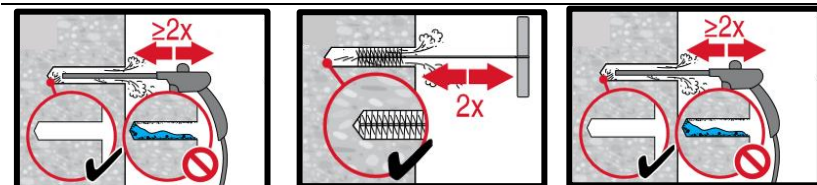

#### Diamond cored holes with Hilti roughening tool:

#### Compressed air cleaning (CAC)

for all drill hole diameters  $d_0$  and drill hole depths  $h_0$ .

## Injection

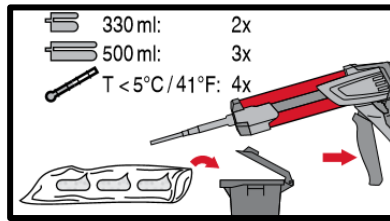
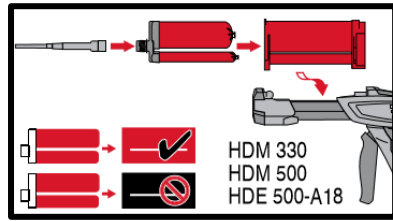

**Injection system preparation.**

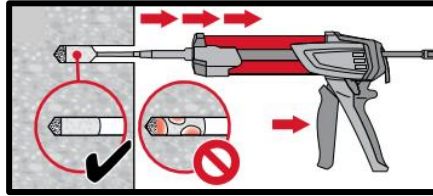
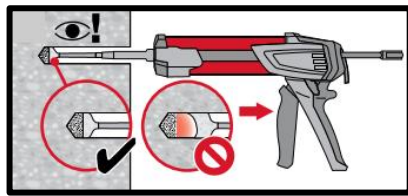

**Injection method for drill hole depth**  
 $h_{ef} \leq 250 \text{ mm}$ .

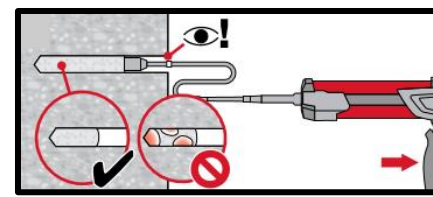
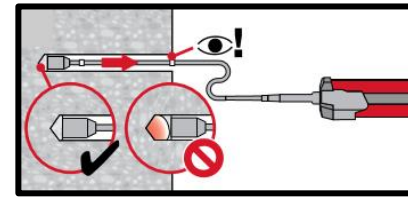

**Injection method for drill hole depth**  
 $h_{ef} > 250 \text{ mm}$ .

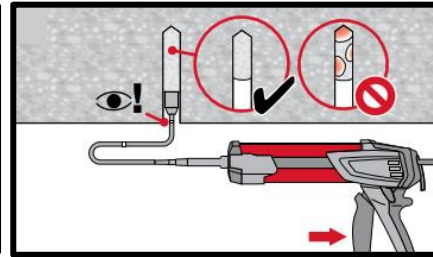
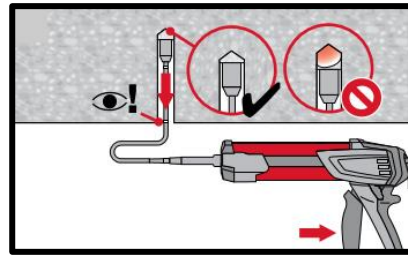

**Injection method for overhead**  
application and/or installation with  
embedment depth  $> 250 \text{ mm}$ .

## Setting the element

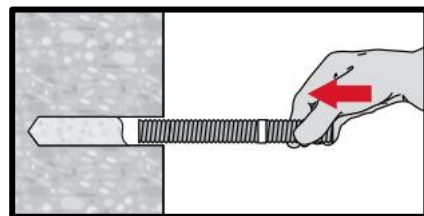

**Setting element**, observe working time  
“ $t_{work}$ ”.

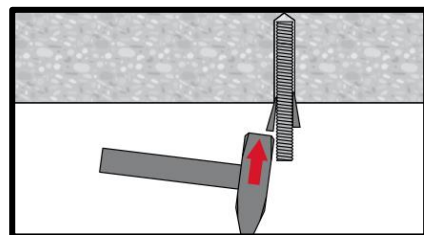

**Setting element for overhead**  
applications, observe working time “ $t_{work}$ ”.

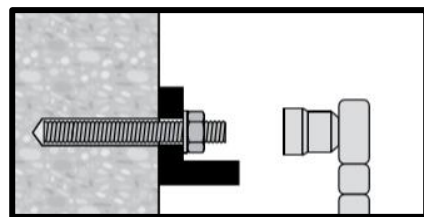

**Loading the anchor** after required  
curing time  $t_{cure}$



## Setting instructions for HIT-Z rods

\*For detailed information on installation see instruction for use given with the package of the product.



### Safety regulations.

Review the Material Safety Data Sheet (MSDS) before use for proper and safe handling! Wear well-fitting protective goggles and protective gloves when working with Hilti HIT-HY 200 A (R)

### Drilling

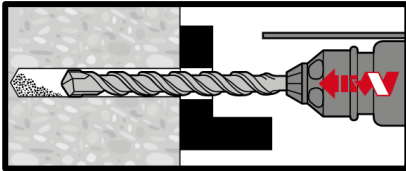

**Hammer drilling: Through-setting**

No cleaning required

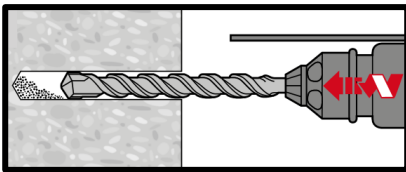

**Hammer drilling: Pre-setting**

No cleaning required

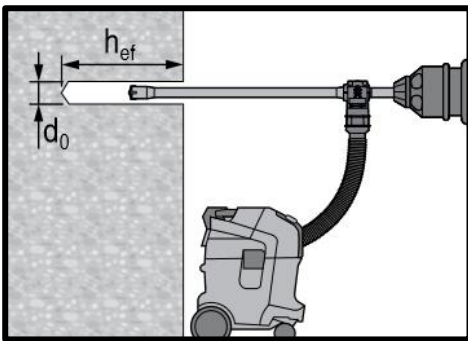

**Hammer drilling with hollow drill bit: Through / pre-setting**

No cleaning required

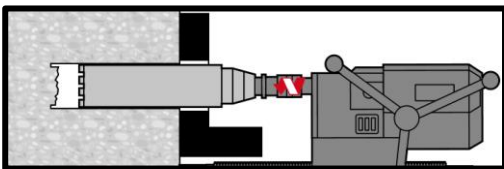

**Diamond coring: Through-setting**

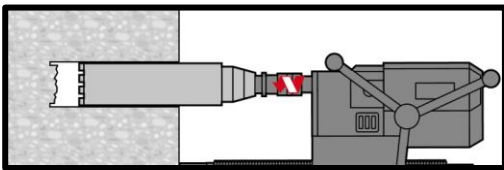

**Diamond coring: Pre-setting**

### Cleaning

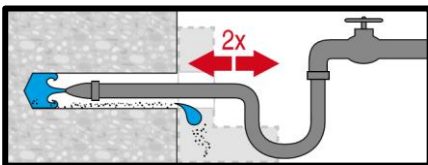

**Hole flushing** required for wet-drilled diamond cored holes.

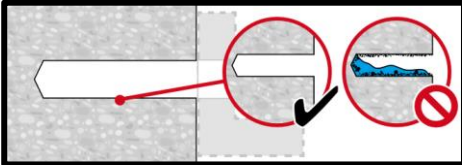
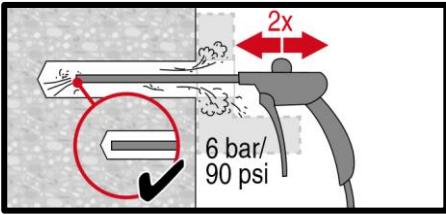

**Evacuation** required for wet-drilled diamond cored holes.

**Injection**

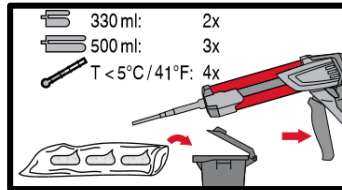
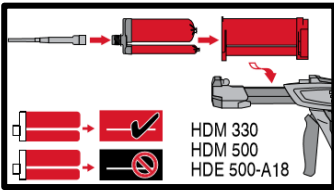

**Injection system preparation.**

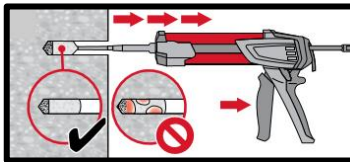
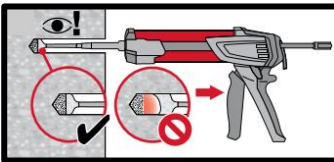

**Injection** of adhesive from the back of the drill hole without forming air voids.

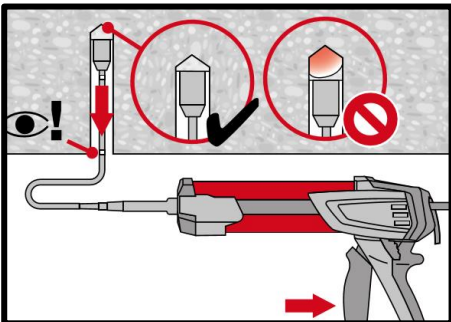

**Overhead installation** only with the aid of extensions and piston plugs.

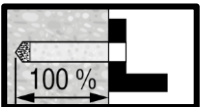

**Through-setting:**  
Fill 100% of the drill hole.

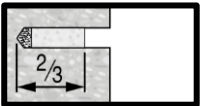

**Pre-setting:**  
Fill approx. 2/3 of the drill hole.

**Setting the element**

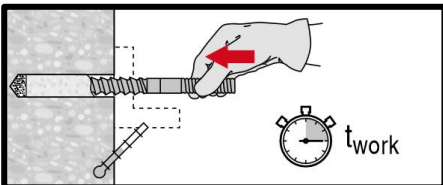

**Setting element** to the required embedment depth before working time "t<sub>work</sub>" has elapsed.

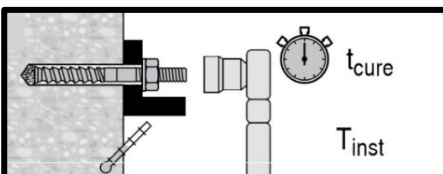

**Loading the anchor:** After required curing time t<sub>cure</sub>.



Concrete

Chemical anchors

Mechanical anchors

Plastic/Light duty metal anchors

Insulation anchors

# HIT-HY 200 injection mortar

Anchor design (EN 1992-4) / Rebar elements / Concrete

Concrete

Chemical anchors

Mechanical anchors

Plastic/Light duty metal anchors

Insulation anchors

## Injection mortar system



Hilti HIT - HY 200-A

330 ml foil pack  
(also available as  
500 ml foil pack)



Hilti HIT - HY 200-R

330 ml foil pack  
(also available as  
500 ml foil pack)



Rebar B500 B  
( $\phi 8$  -  $\phi 32$ )

## Benefits

- **SafeSet** technology: Simplified method of borehole preparation using either Hilti hollow drill bit for hammer drilling or Roughening tool for diamond cored applications
- ETA seismic approval C1
- Suitable for cracked and non-cracked concrete C 12/15 to C 50/60
- Suitable for dry and water saturated concrete
- High loading capacity, excellent handling
- Small edge distance and anchor spacing possible
- In service temperature range up to 120°C short term / 72°C long term
- Large diameter applications
- Two mortar versions: HY 200-R for slow cure applications and HY 200-A for fast cure applications

## Base material



Concrete  
(non-cracked)



Concrete  
(cracked)



Dry concrete

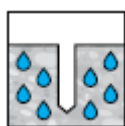

Wet  
concrete



Static/  
quasi-static



Seismic,  
ETA-C1



Fire  
resistance

## Load conditions

## Installation conditions

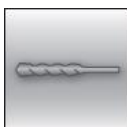

Hammer  
drilling



Diamond  
drilled holes <sup>a)</sup>

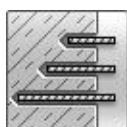

Variable  
embedment  
depth

**SAFESET**

Hilti  
**SafeSet**  
technology

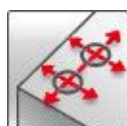

Small edge  
distance and  
spacing



European  
Technical  
Assessment



CE  
conformity



**PROFIS**  
Rebar  
design  
Software

## Other informations

a) Diamond drilling only with Roughening Tool (RT).

## Approvals / certificates

Description	Product	Authority / Laboratory	No. / date of issue
European Technical Assessment <sup>a)</sup>	HY 200-A	DIBt, Berlin	ETA-11/0493 / 2019-08-30
European Technical Assessment <sup>a)</sup>	HY 200-R	DIBt, Berlin	ETA-12/0084 / 2019-08-28

a) All data given in this section according to ETA-11/0493 issue 2019-08-30 and to ETA-12/0084 issue 2019-08-28.

## Static and quasi-static loading (for a single anchor)

### All data in this section applies to

- Correct setting (See setting instruction)
- No edge distance and spacing influence
- Steel failure
- Base material thickness, as specified in the table
- One typical embedment depth, as specified in the table
- One anchor material, as specified in the tables
- Concrete C 20/25,  $f_{ck,cube} = 25 \text{ N/mm}^2$
- Temperate range I  
(min. base material temperature  $-40^\circ\text{C}$ , max. long term/short term base material temperature:  $+24^\circ\text{C}/40^\circ\text{C}$ )

### Embedment depth and base material thickness for static and quasi-static loading data

Anchor- size	$\phi 8$	$\phi 10$	$\phi 12$	$\phi 14$	$\phi 16$	$\phi 20$	$\phi 25$	$\phi 26$	$\phi 28$	$\phi 30$	$\phi 32$
Typical embedment depth [mm]	80	90	110	125	125	170	210	240	270	270	300
Base material thickness [mm]	110	120	145	165	165	220	275	305	340	345	380

### Characteristic resistance

Anchor- size	$\phi 8$	$\phi 10$	$\phi 12$	$\phi 14$	$\phi 16$	$\phi 20$	$\phi 25$	$\phi 26$	$\phi 28$	$\phi 30$	$\phi 32$
<b>Non-cracked concrete</b>											
Tensile $N_{Rk}$ [kN]	24,1	33,9	49,8	66,0	68,7	109	150	183	218	218	256
Shear $V_{Rk}$ [kN]	14,0	22,0	31,0	42,0	55,0	86,0	135	146	169	194	221
<b>Cracked concrete</b>											
Tensile $N_{Rk}$ [kN]	-	14,1	29,0	38,5	44,0	74,8	105	128	153	153	179
Shear $V_{Rk}$ [kN]	-	22,0	31,0	42,0	55,0	86,0	135	146	169	194	221

### Design resistance

Anchor- size	$\phi 8$	$\phi 10$	$\phi 12$	$\phi 14$	$\phi 16$	$\phi 20$	$\phi 25$	$\phi 26$	$\phi 28$	$\phi 30$	$\phi 32$
<b>Non-cracked concrete</b>											
Tensile $N_{Rd}$ [kN]	16,1	22,6	33,2	44,0	45,8	72,7	99,8	122	146	146	170
Shear $V_{Rd}$ [kN]	9,3	14,7	20,7	28,0	36,7	57,3	90,0	97,3	113	129	147
<b>Cracked concrete</b>											
Tensile $N_{Rd}$ [kN]	-	9,4	19,4	25,7	29,3	49,8	69,9	85,4	102	102	119
Shear $V_{Rd}$ [kN]	-	14,7	20,7	28,0	36,7	57,3	90,0	97,3	113	129	147

## Seismic loading (for a single anchor)

### All data in this section applies to:

- Correct setting (See setting)
- No edge distance and spacing influence
- Steel failure
- Minimum base material thickness
- Concrete C 20/25,  $f_{ck,cube} = 25 \text{ N/mm}^2$
- Temperature range I  
(min, base material temperature  $-40^\circ\text{C}$ , max, long term/short term base material temperature:  $+24^\circ\text{C}/40^\circ\text{C}$ )
- $\alpha_{gap} = 1,0$

### Embedment depth and base material thickness in case of seismic performance category C1

Anchor- size	$\phi 8$	$\phi 10$	$\phi 12$	$\phi 14$	$\phi 16$	$\phi 20$	$\phi 25$	$\phi 26$	$\phi 28$	$\phi 30$	$\phi 32$
Typical embedment depth [mm]	-	90	110	125	125	170	210	240	270	270	300
Base material thickness [mm]	-	120	145	165	165	220	275	305	340	345	380

### Characteristic resistance in case of seismic performance category C1

Anchor- size	$\phi 8$	$\phi 10$	$\phi 12$	$\phi 14$	$\phi 16$	$\phi 20$	$\phi 25$	$\phi 26$	$\phi 28$	$\phi 30$	$\phi 32$
Tensile $N_{Rk, se}$	-	12,4	25,3	33,5	38,3	65,2	99,6	120	145	145	170
Shear $V_{Rk, se}$	-	15,0	22,0	29,0	39,0	60,0	95,0	102	118	136	155

### Design resistance in case of seismic performance category C1

Anchor- size	$\phi 8$	$\phi 10$	$\phi 12$	$\phi 14$	$\phi 16$	$\phi 20$	$\phi 25$	$\phi 26$	$\phi 28$	$\phi 30$	$\phi 32$
Tensile $N_{Rd, se}$	-	8,3	16,9	22,4	25,6	43,4	66,4	79,7	96,6	96,8	113
Shear $V_{Rd, se}$	-	10,0	14,7	19,3	26,0	40,0	63,3	68,0	78,7	90,7	103

## Materials

### Mechanical properties

Anchor size	$\phi 8$	$\phi 10$	$\phi 12$	$\phi 14$	$\phi 16$	$\phi 20$	$\phi 25$	$\phi 26$	$\phi 28$	$\phi 30$	$\phi 32$
Nominal tensile strength $f_{uk}$ [N/mm <sup>2</sup> ]	550	550	550	550	550	550	550	550	550	550	550
Yield strength $f_{yk}$ [N/mm <sup>2</sup> ]	500	500	500	500	500	500	500	500	500	500	500
Stressed cross-section $A_s$ [mm <sup>2</sup> ]	50,3	78,5	113	154	201	314	491	531	616	707	804
Moment of resistance $W$ [mm <sup>3</sup> ]	50,3	98,2	170	269	402	785	1534	1726	2155	2651	3217

### Material quality

Part	Material
Rebar EN 1992-1-1:2004 and AC:2010	Bars and de-coiled rods class B or C according to NDP or NCL of EN 1992-1-1/NA:2013

## Setting information

### Installation temperature range

- 10°C to + 40°C

### Service temperature range

Hilti HIT-HY 200 injection mortar may be applied in the temperature ranges given below, An elevated base material temperature may lead to a reduction of the design bond resistance,

Temperature range	Base material temperature	Max, long term base material temperature	Max, short term base material temperature
Temperature range I	-40 °C to + 40 °C	+ 24 °C	+ 40 °C
Temperature range II	-40 °C to + 80 °C	+ 50 °C	+ 80 °C
Temperature range III	-40 °C to + 120 °C	+ 72 °C	+ 120 °C

### Max, short term base material temperature

Short term elevated base material temperatures are those that occur over brief intervals, e.g, as a result of diurnal cycling,

### Max, long term base material temperature

Long term elevated base material temperatures are roughly constant over significant periods of time,

### Curing and working time

Temperature of the base material	HIT-HY 200-A		HIT-HY 200-R	
	Maximum working time $t_{work}$	Minimum curing time $t_{cure}$	Maximum working time $t_{work}$	Minimum curing time $t_{cure}$
- 10°C < $T_{BM}$ ≤ - 5°C	1,5 h	7 h	3 h	20 h
- 5°C < $T_{BM}$ ≤ 0°C	50 min	4 h	2 h	8 h
0°C < $T_{BM}$ ≤ 5°C	25 min	2 hour	1 h	4 h
5°C < $T_{BM}$ ≤ 10°C	15 min	75 min	40 min	2,5 h
10°C < $T_{BM}$ ≤ 20°C	7 min	45 min	15 min	1,5 h
20°C < $T_{BM}$ ≤ 30°C	4 min	30 min	9 min	1 h
30°C < $T_{BM}$ ≤ 40°C	3 min	30 min	6 min	1 h

### Installation equipment

Anchor size	φ8	φ10	φ12	φ14	φ16	φ20	φ25	φ26	φ28	φ30	φ32
Rotary hammer	TE 2 (-A) – TE 16 (-A)					TE 40 – TE 80					
Other tools	Compressed air gun, blow out pump Set of cleaning brushes, dispenser										



### Setting details

Anchor size	Ø8	Ø10	Ø12	Ø14	Ø16	Ø20	Ø25	Ø26	Ø28	Ø30	Ø32	
Nominal diameter of drill bit $d_0$ [mm]	10 / 12 <sup>a)</sup>	12 / 14 <sup>a)</sup>	14 / 16 <sup>a)</sup>	18	20	25	32	32	35	37	40	
Effective anchorage and drill hole depth range <sup>b)</sup>	$h_{ef,min}$ [mm]	60	60	70	75	80	90	100	104	112	120	128
	$h_{ef,max}$ [mm]	160	200	240	280	320	400	500	520	560	600	640
Minimum base material thickness $h_{min}$ [mm]	$h_{ef} + 30 \text{ mm} \geq 100 \text{ mm}$			$h_{ef} + 2 d_0$								
Minimum spacing $s_{min}$ [mm]	40	50	60	70	80	100	125	130	140	150	160	
Minimum edge distance $c_{min}$ [mm]	40	45	45	50	50	65	70	75	75	80	80	
Critical spacing for splitting failure $s_{cr,sp}$ [mm]	$2 c_{cr,sp}$											
Critical edge distance for splitting failure <sup>c)</sup> $c_{cr,sp}$ [mm]	$1,0 \cdot h_{ef}$		for $h / h_{ef} \geq 2,0$									
	$4,6 h_{ef} - 1,8 h$		for $2,0 > h / h_{ef} > 1,3$									
	$2,26 h_{ef}$		for $h / h_{ef} \leq 1,3$									
Critical spacing for concrete cone failure $s_{cr,N}$ [mm]	$2 c_{cr,N}$											
Critical edge distance for concrete cone failure <sup>d)</sup> $c_{cr,N}$ [mm]	$1,5 h_{ef}$											

For spacing (edge distance) smaller than critical spacing (critical edge distance) the design loads have to be reduced,

- a) Both given values for drill bit diameter can be used
- b)  $h_{ef,min} \leq h_{ef} \leq h_{ef,max}$  ( $h_{ef}$ : embedment depth)
- c)  $h$ : base material thickness ( $h \geq h_{min}$ )
- d) The critical edge distance for concrete cone failure depends on the embedment depth  $h_{ef}$  and the design bond resistance. The simplified formula given in this table is on the safe side.

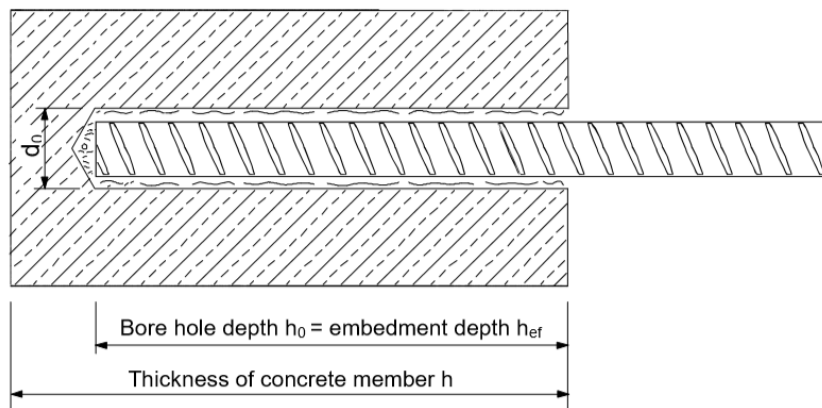
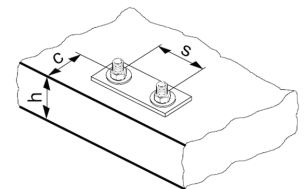



### Drilling and cleaning diameters

Rebar	Hammer drill (HD)	Hollow Drill Bit (HDB)	Diamond coring with Roughening Tool (RT) <sup>b)</sup>	Brush HIT-RB
d <sub>0</sub> [mm]				size [mm]
φ8	12 / 10 <sup>a)</sup>	12	-	12 / 10 <sup>a)</sup>
φ10	14 / 12 <sup>a)</sup>	14 / 12 <sup>a)</sup>	-	14 / 12 <sup>a)</sup>
φ12	16 / 14 <sup>a)</sup>	16 / 14 <sup>a)</sup>	-	16 / 14 <sup>a)</sup>
φ14	18	18	18	18
φ16	20	20	20	20
φ20	25	25	25	25
φ25	32	32	32	32
φ26	32	32	35	32
φ28	35	35	35	35
φ30	37	-	37	37
φ32	40	-	40	40

- a) Both given values can be used  
b) No cleaning required

### Associated components for the use of Hilti Roughening tool TE-YRT

Diamond coring		Roughening tool TE-YRT	Wear gauge RTG...
d <sub>0</sub> [mm]		d <sub>0</sub> [mm]	size
Nominal	measured		
18	17,9 to 18,2	18	18
20	19,9 to 20,2	20	20
22	21,9 to 22,2	22	22
25	24,9 to 25,2	25	25
28	27,9 to 28,2	28	28
30	29,9 to 30,2	30	30
32	31,9 to 32,2	32	32
35	34,9 to 35,2	35	35

### Installation parameters for use of the Hilti Roughening tool TE-YRT

h <sub>ef</sub> [mm]	Minimum roughening time t <sub>roughen</sub> [sec] (t <sub>roughen</sub> [sec] = h <sub>ef</sub> [mm] / 10)	Minimum blowing time t <sub>blowing</sub> [sec] (t <sub>blowing</sub> [sec] = t <sub>roughen</sub> [sec] + 20)
0 to 100	10	30
101 to 200	20	40
201 to 300	30	50
301 to 400	40	60
401 to 500	50	70
501 to 600	60	80

## Setting instructions

\*For detailed information on installation see instruction for use given with the package of the product,



### Safety regulations.

Review the Material Safety Data Sheet (MSDS) before use for proper and safe handling! Wear well-fitting protective goggles and protective gloves when working with Hilti HIT-HY 200.

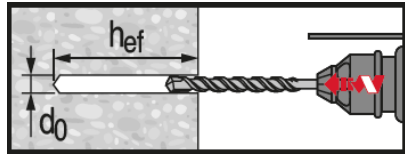

**Hammer drilled hole (HD)**

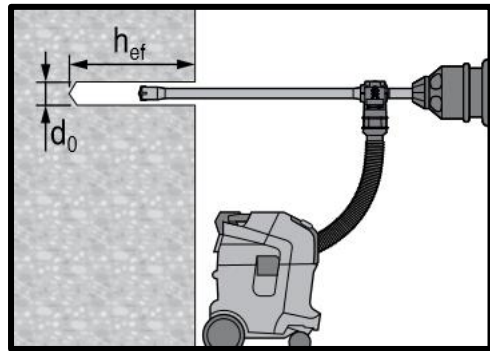

**Hammer drilled hole with Hollow Drilled Bit (HDB)**

No cleaning required

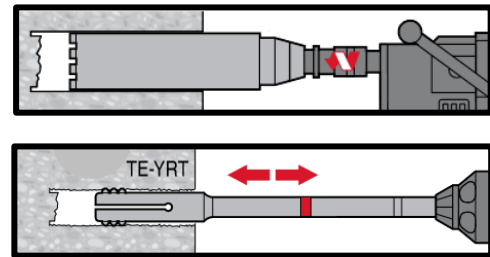

**Diamond Drilling + Roughening Tool (DD+RT)**

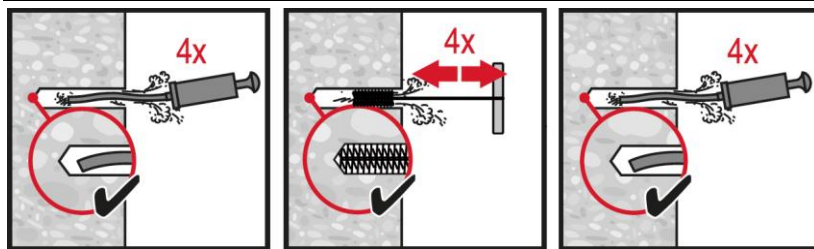

**Hammer drilling:**

**Manual cleaning (MC)**

for drill diameters  $d_0 \leq 20$  mm and drill hole depth  $h_0 \leq 10 \cdot d$ .

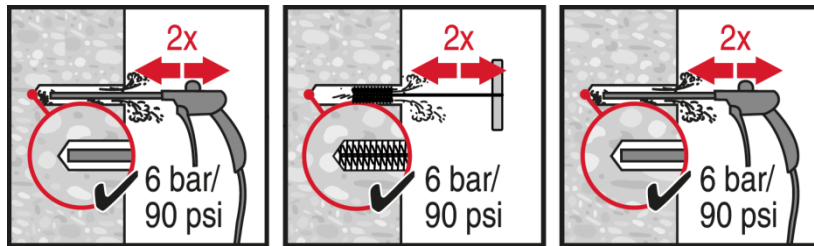

**Hammer drilling:**

**Compressed air cleaning (CAC)**

for all drill hole diameters  $d_0$  and drill hole depths  $h_0 \leq 20 \cdot d$ .

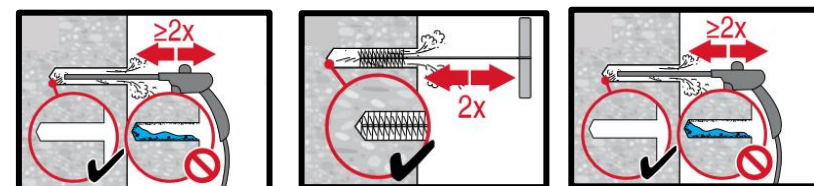

**Diamond cored holes with Hilti roughening tool:**

**Compressed air cleaning (CAC)**

for all drill hole diameters  $d_0$  and drill hole depths  $h_0$ .

Concrete

Chemical anchors

Mechanical anchors

Plastic/Light duty metal anchors

Insulation anchors

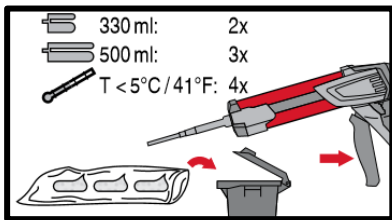
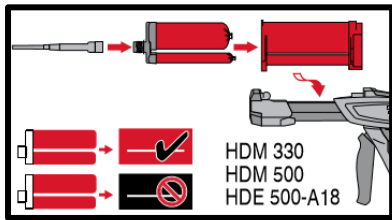

**Injection system preparation.**

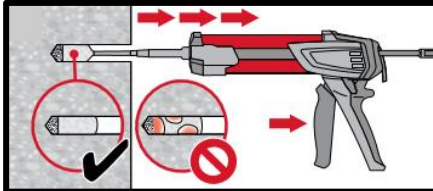
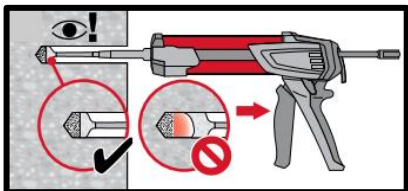

**Injection method for drill hole depth**  
 $h_{ef} \leq 250 \text{ mm}$ .

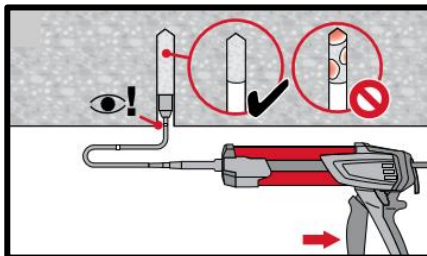
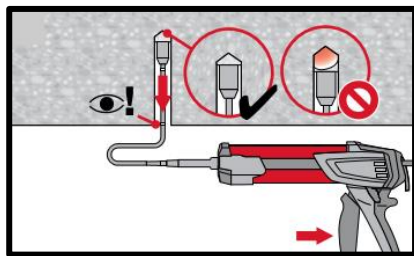

**Injection method for overhead**  
application and/or installations with  
embedment depth  $h_{ef} \geq 250 \text{ mm}$ .

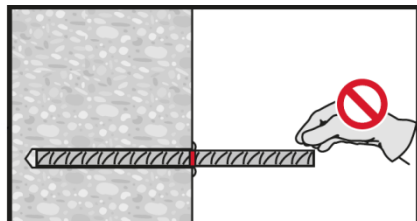
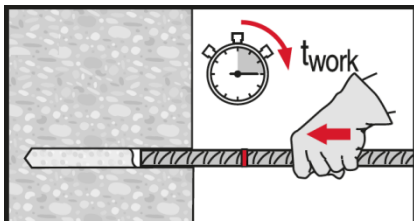

**Setting element, observe working time**  
“ $t_{work}$ ”.

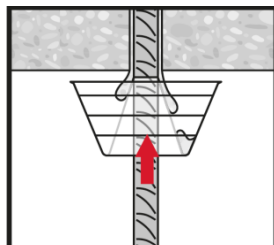
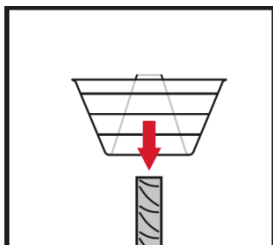
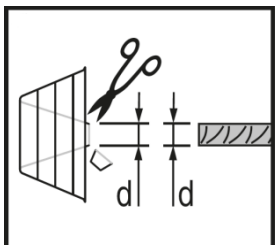

**Setting element for overhead**  
applications, observe working time “ $t_{work}$ ”.

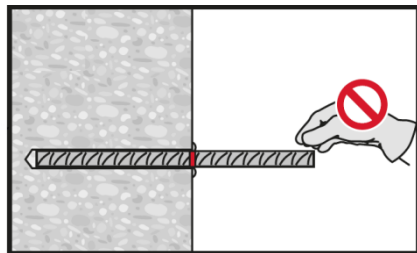
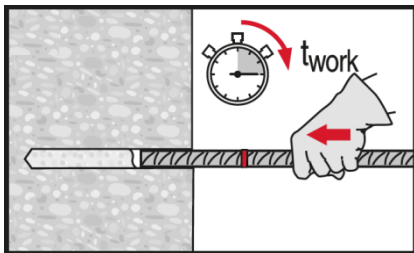

**Setting element, observe working time**  
“ $t_{work}$ ”.



# HIT-HY 200 injection mortar

Rebar design (EOTA TR023) / Rebar elements / Concrete

## Injection mortar system



Hilti HIT-HY 200-R  
330 ml foil pack  
(also available as  
500 ml foil pack)



Hilti HIT-HY 200-A  
330 ml foil pack  
(also available as  
500 ml foil pack)



Rebar  
( $\phi 8$  -  $\phi 32$ )

## Benefits

- **SafeSet** technology: Simplified method of borehole preparation using either Hilti hollow drill bit for hammer drilling or Roughening tool for diamond cored applications
- HY 200-R version is formulated for best handling and cure time specifically for rebar applications
- Approved for ETA seismic C1 approval for post-installed-rebar
- Suitable for concrete C 12/15 to C 50/60
- Suitable for dry and water saturated concrete
- For rebar diameters up to 32 mm
- Non corrosive to rebar elements
- Good load capacity at elevated temperatures
- Suitable for embedment length up to 1000 mm
- Suitable for applications down to -10 °C
- Two mortar versions: HY 200-A for slow cure applications and HY 200-R for fast cure applications

## Base material



Concrete (non-cracked)



Concrete (cracked)

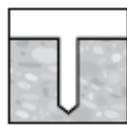

Dry concrete



Wet concrete



Static/  
quasi-static



Seismic,  
CSTB<sup>a)</sup>/ETA-C1<sup>b)</sup>



Fire resistance

## Installation conditions

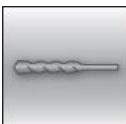

Hammer drilling



Diamond drilled holes<sup>c)</sup>

**SAFESET**

Hilti SafeSet technology

## Load conditions

## Other informations



European  
Technical  
Assessment



CE  
conformity



PROFIS Rebar  
design  
Software

<sup>a)</sup>Seismic data only valid for HY 200-A

<sup>b)</sup>Seismic data only valid for HY 200-R

<sup>c)</sup>Diamond drilling only with Roughening Tool (RT)

Concrete

Chemical anchors

Mechanical anchors

Plastic/Light duty metal anchors

Insulation anchors

### Approvals / certificates

Description	Product	Authority / Laboratory	No. / date of issue
European Technical Assessment <sup>a)</sup>	HY 200-A	DIBt, Berlin	ETA-11/0492 / 2014-06-26
European Technical Assessment <sup>a)</sup>	HY 200-R	DIBt, Berlin	ETA-12/0083 / 2019-06-21
Assessment (fire)	HY 200-A/R	CSTB, Marne la Vallée	Z-21.8-1948 / 2013-11-14
Assessment (fire)	HY 200-A/R	CSTB, Marne la Vallée	Z-21.8-1947 / 2014-07-22

<sup>a)</sup> All data given in this section according to ETA-11/0492, issue 2014-06-26 and ETA-12/0083, issue 2019-06-21.

### Static and quasi-static loading

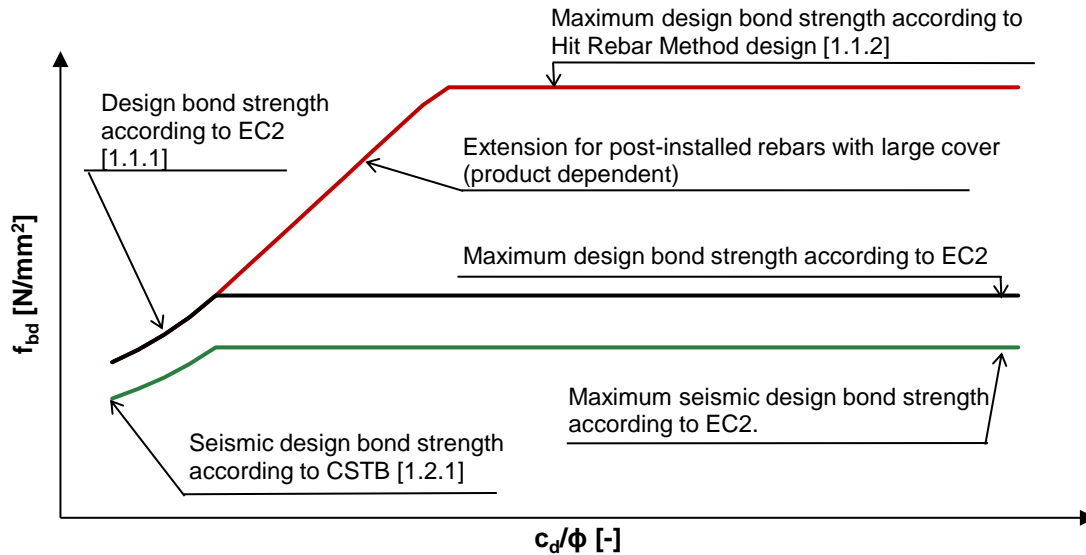

Effective limit on bond stress for post-installed rebar using Hilti mortar systems and design bond strength values as provided by the EC2.

### Static EC2 design (small concrete cover)

#### Design bond strength in N/mm<sup>2</sup> for good bond conditions

All allowed drilling methods									
Rebar - size	Concrete class								
	C12/15	C16/20	C20/25	C25/30	C30/37	C35/45	C40/50	C45/55	C50/60
φ8 - φ32	1,6	2,0	2,3	2,7	3,0	3,4	3,7	4,0	4,3

For poor bond conditions multiply the values by 0,7. Values valid for non-cracked and cracked concrete.

### Static Hit Rebar Method design (large concrete cover)

#### Maximum design bond strength in N/mm<sup>2</sup> for good bond conditions

Non-cracked concrete, all allowed drilling methods									
Temperature range	Rebar - size	Concrete class							
		C20/25	C25/30	C30/37	C35/45	C40/45	C45/55	C50/60	
I: 40°C/24°C	φ8 - φ32	8	8,2	8,3	8,4	8,6	8,7	8,8	
II: 58°C/35°C		6,7	6,8	6,9	7,0	7,1	7,2	7,3	
III: 70°C/43°C		5,7	5,8	5,9	6,0	6,1	6,1	6,2	
Cracked concrete, all allowed drilling methods									
I: 40°C/24°C	φ12 - φ32	4,7	4,8	4,8	4,9	5,0	5,1	5,1	
II: 58°C/35°C		3,7	3,7	3,8	3,9	3,9	4,0	4,0	
III: 70°C/43°C		3,3	3,4	3,5	3,5	3,6	3,6	3,7	

For poor bond conditions multiply the values by 0,7. \*The reduction factor for rebar diameter equal to 10 mm is 0,72



### Additional Hilti Technical Data:

Reduction factor for splitting with large concrete cover:  $\delta = 0,306$  (Hilti additional data)

### Minimum anchorage length and minimum lap length

The minimum anchorage length  $l_{b,min}$  and the minimum lap length  $l_{0,min}$  according to EN 1992-1-1 shall be multiplied by relevant **Amplification factor  $\alpha_{lb}$**  in the table below.

#### Amplification factor $\alpha_{lb}$ for the min. anchorage length and min. lap length for

All allowed hammer drilling methods									
Rebar - size	Concrete class								
	C12/15	C16/20	C20/25	C25/30	C30/37	C35/45	C40/50	C45/55	C50/60
$\phi 8 - \phi 32$	1,0								

#### Anchorage length for characteristic steel strength $f_{yk}=500 \text{ N/mm}^2$ for good conditions

All allowed drilling methods									
Rebar-size	Concrete class	Yielding load [kN]	$l_{b,min}^{1)}$ [mm]	$l_{0,min}^{1)}$ [mm]	$l_{bd,y}^{2)}$ ( $\alpha 2=1$ ) [mm]	$l_{bd,y}^{3)}$ ( $\alpha 2=0.7$ ) [mm]	$l_{bd,y,HRM}^{4)}$ ( $\alpha 2<0.7$ ) [mm]	$l_{max}^{5)}$ $-10^{\circ}\text{C} \leq t \leq 0^{\circ}\text{C}$ [mm]	$l_{max}^{6)}$ $t > 0^{\circ}\text{C}$ [mm]
$\phi 8$	C20/25	21,9	113	200	378	265	109	700	1000
$\phi 8$	C50/60	21,9	100	200	202	142	99	700	1000
$\phi 10$	C20/25	34,1	142	200	473	331	136	700	1000
$\phi 10$	C50/60	34,1	100	200	253	177	124	700	1000
$\phi 12$	C20/25	49,2	170	200	567	397	163	700	1000
$\phi 12$	C50/60	49,2	120	200	303	212	148	700	1000
$\phi 14$	C20/25	66,9	198	210	662	463	190	700	1000
$\phi 14$	C50/60	66,9	140	210	354	248	173	700	1000
$\phi 16$	C20/25	87,4	227	240	756	529	217	700	1000
$\phi 16$	C50/60	87,4	160	240	404	283	198	700	1000
$\phi 18$	C20/25	110,6	255	270	851	595	245	700	1000
$\phi 18$	C50/60	110,6	180	270	455	319	222	700	1000
$\phi 20$	C20/25	136,6	284	300	945	662	272	700	1000
$\phi 20$	C50/60	136,6	200	300	506	354	247	700	1000
$\phi 22$	C20/25	165,3	312	330	1040	728	299	700	1000
$\phi 22$	C50/60	165,3	220	330	556	389	272	700	1000
$\phi 24$	C20/25	196,7	340	360	1134	794	326	700	1000
$\phi 24$	C50/60	196,7	240	360	607	425	296	700	1000
$\phi 25$	C20/25	213,4	354	375	1181	827	340	700	1000
$\phi 25$	C50/60	213,4	250	375	632	442	309	700	1000
$\phi 26$	C20/25	230,8	369	390	1229	860	353	700	1000
$\phi 26$	C50/60	230,8	260	390	657	460	321	700	1000
$\phi 28$	C20/25	267,7	397	420	1323	926	380	700	1000
$\phi 28$	C50/60	267,7	280	420	708	495	346	700	1000
$\phi 30$	C20/25	307,3	425	450	1418	992	408	700	1000
$\phi 30$	C50/60	307,3	300	450	758	531	371	700	1000
$\phi 32$	C20/25	349,7	454	480	1512	1059	435	700	1000
$\phi 32$	C50/60	349,7	320	480	809	566	395	700	1000

- 1) According to EC2: EN 1992-1-1:2004  $l_{b,min}$  (8.6) and  $l_{0,min}$  (8.11) are calculated for good bond conditions with characteristic yield strength  $f_{yk} = 500 \text{ N/mm}^2$ ,  $\gamma_M=1,15$  and  $\alpha_6 = 1,0$
- 2) Embedment depth for yield of the rebar and for  $c_d/\phi = 1$  (characteristic yield strength  $f_{yk} = 500 \text{ N/mm}^2$ )
- 3) Embedment depth for yield of the rebar and for  $c_d/\phi = 3$  (characteristic yield strength  $f_{yk} = 500 \text{ N/mm}^2$ )
- 4) Embedment depth according to Hit Rebar design for yield of the rebar and for  $c_d/\phi > 8$  (Temperature range 1,
- 5) characteristic yield strength  $f_{yk} = 500 \text{ N/mm}^2$ )
- 6)  $c_t$ =concrete temperature

Concrete  
Chemical anchors  
Mechanical anchors  
Plastic/Light duty metal anchors  
Insulation anchors

## Seismic data

### Seismic data according to ETA-12/0083 assessment

#### Seismic reduction factor $k_{b,seis}$ for hammer drilling (HD) and (HDB) and compressed air drilling (CA)

Rebar - size	Reduction factor $k_{b,seis}$							
	Concrete class							
	C16/20	C20/25	C25/30	C30/37	C35/45	C40/50	C45/55	C50/60
$\phi 12 - \phi 18$	1,0				0,90	0,82	0,76	0,71
$\phi 20 - \phi 30$	1,0						0,92	0,86
$\phi 32$	1,0							

For poor bond conditions multiply the values 0,7.

#### Design values for the ultimate bond resistance $f_{bd,seis}$ <sup>1)</sup> in N/mm<sup>2</sup> for seismic loading for hammer drilling (HD) and (HDB) and compressed air drilling (CA)

Rebar - size	Bond resistance $f_{bd,seis}$							
	Concrete class							
	C16/20	C20/25	C25/30	C30/37	C35/45	C40/50	C45/55	C50/60
$\phi 12 - \phi 18$	2,0	2,3	2,7	3,0				
$\phi 20 - \phi 30$	2,0	2,3	2,7	3,0	3,4	3,7		
$\phi 32$	2,0	2,3	2,7	3,0	3,4	3,7	4,0	4,3

<sup>1)</sup> According to EN 1992-1-1:2004 for good bond conditions. For all other bond conditions multiply the values by 0.7.

## Fire resistance

### a) Anchoring application

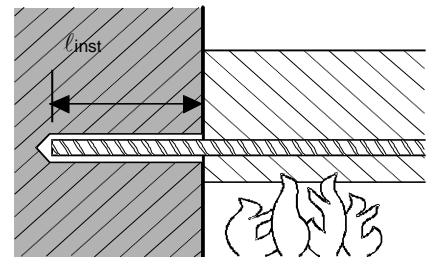

Maximum force ( $F_{s,T,max}$ ) in rebar in conjunction with HIT-HY 200 as a function of embedment depth ( $l_{inst}$ ) for the fire resistance classes F30 to F180 according to EC2.

Rebar-size	$F_{s,T,max}$ [kN]	$l_{inst}$ [mm]	Fire resistance of bar [kN]				
			R30	R60	R90	R120	R180
$\phi 8$	16,19	80	3,0	0,7	0,2	0,0	0,0
		120	7,0	2,2	1,3	0,7	0,2
		170	16,2	10,2	9,2	4,0	1,7
		210		16,2	11,0	7,5	
		230	14,5		10,9		
		250	16,2		14,5		
		300	16,2				
$\phi 10$	25,29	100	6,1	2,0	1,0	0,4	0,0
		150	19,3	9,3	7,1	2,2	1,0
		190	25,3	18,0	15,9	9,3	4,9
		230		25,3	24,7	18,1	13,7
		260	24,7		20,3		
		280	25,3		24,7		
		320	25,3				
$\phi 12$	36,42	120	15,3	6,0	1,9	1,1	0,3
		180	31,0	19,0	17,8	8,5	7,0

Maximum force ( $F_{s,T,max}$ ) in rebar in conjunction with HIT-HY 200 as a function of embedment depth ( $\ell_{inst}$ ) for the fire resistance classes F30 to F180 according to EC2

$\phi 12$	<b>36,42</b>	220	<b>36,4</b>	29,6	27,0	19,1	13,8		
		260		<b>36,4</b>	<b>36,4</b>	<b>36,4</b>	29,7	24,4	
		280					35,0	29,6	
		300					<b>36,4</b>	34,9	
		340						<b>36,4</b>	<b>36,4</b>
$\phi 14$	<b>49,58</b>	140	24,0	9,9	6,9	2,6	1,0		
		210	45,0	31,4	28,5	25,7	13,0		
		240	<b>49,6</b>	40,6	37,7	32,8	22,3		
		280		<b>49,6</b>	<b>49,6</b>	<b>49,6</b>	40,7	34,6	
		300					44,7	40,7	
		330					<b>49,6</b>	48,1	
		360						<b>49,6</b>	<b>49,6</b>
$\phi 16$	<b>64,75</b>	160					34,5	18,4	14,9
		240	62,6	46,4	43,0	37,7	25,5		
		260	<b>64,8</b>	53,5	50,0	44,7	32,5		
		300		<b>64,8</b>	<b>64,8</b>	<b>64,8</b>	57,0	49,6	
		330					61,3	57,2	
		360					<b>64,8</b>	62,7	
		400						<b>64,8</b>	<b>64,8</b>
20	<b>101,18</b>	200					60,7	40,0	36,3
		250	78,3	62,5	58,3	51,3	36,3		
		310	<b>101,2</b>	88,9	84,6	77,6	62,6		
		350		<b>101,2</b>	<b>101,2</b>	<b>101,2</b>	94,2	80,2	
		370					83,5		
		390					97,8		
		430					<b>101,2</b>		
$\phi 25$	<b>158,09</b>	250					97,9	78,1	72,6
		280	126,5	94,6	89,4	81,2	61,8		
		370	<b>158,1</b>	144,0	127,9	119,7	111,2		
		410		<b>158,1</b>	<b>158,1</b>	<b>158,1</b>	150,0	141,8	123,2
		430					150,0	144,2	
		450					<b>158,1</b>	155,2	
		500					<b>158,1</b>	<b>158,1</b>	
$\phi 32$	<b>158,09</b>	250					97,9	78,1	72,6
		280	126,5	94,6	89,4	81,2	61,8		
		370	<b>158,1</b>	144,0	127,9	119,7	111,2		
		410		<b>158,1</b>	<b>158,1</b>	<b>158,1</b>	150,0	141,8	123,2
		430					150,0	144,2	
		450					<b>158,1</b>	155,2	
		500					<b>158,1</b>	<b>158,1</b>	

Characteristic yield strength  $f_{yk} = 500 \text{ N/mm}^2$

Steel failure



## b) Overlap joint application

Max. bond stress,  $f_{bd, FIRE}$ , depending on actual clear concrete cover for classifying the fire resistance.

It must be verified that the actual force in the bar during a fire,  $F_{s,T}$ , can be taken up by the bar connection of the selected length,  $l_{inst}$ . Note: Cold design for ULS is mandatory.

$$F_{s,T} \leq (l_{inst} - c_f) \cdot \phi \cdot \pi \cdot f_{bd, FIRE} \quad \text{where: } (l_{inst} - c_f) \geq l_s;$$

$l_s$  = lap length

$\phi$  = nominal diameter of bar

$l_{inst} - c_f$  = selected overlap joint length; this must be at least  $l_s$ ,

but may not be assumed to be more than  $80 \phi$

$f_{bd, FIRE}$  = bond stress when exposed to fire

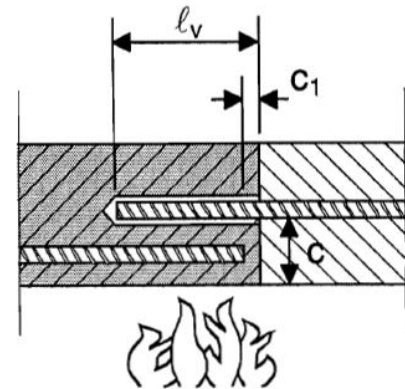

**Critical temperature-dependent bond stress,  $\tau_c$ , concerning “overlap joint” for Hilti HIT-HY 200 injection adhesive in relation to fire resistance class and required minimum concrete coverage c.**

Clear concrete cover c [mm]	Max. bond stress, $\tau_c$ [N/mm <sup>2</sup> ]					
	R30	R60	R90	R120	R180	
30	0,6	0,3	-	-	-	
35	0,7	0,3				
40	0,9	0,4	0,2	-	-	
45	1,0	0,4	0,2			
50	1,2	0,5	0,3	0,2	-	
55	1,5	0,6	0,3			
60	1,8	0,8	0,4	0,3	-	
65	2,2	0,9	0,5	0,3		
70		1,0	0,5	0,3		
75		1,2	0,6	0,4	0,2	
80		1,5	0,7	0,5	0,3	
85		1,7	0,8	0,5	0,3	
90		2,0	1,0	0,6	0,3	
95		2,2	2,2	1,1	0,7	0,4
100				1,3	0,8	0,4
105				1,5	0,9	0,5
110				1,7	1,1	0,5
115	2,0			1,2	0,6	
120	2,2	2,2	2,2	1,4	0,6	
125				1,6	0,7	
130				1,9	0,8	
135				2,1	2,1	2,1
200	2,3					

## Materials

### Material quality

Part	Material
Rebar EN 1992-1-1	Bars and de-coiled rods class B or C with $f_{yk}$ and $k$ according to NDP or NCL of EN 1992-1-1 $f_{uk} = f_{tk} = k \cdot f_{yk}$

### Fitness for use

Some creep tests have been conducted in accordance with ETAG guideline 001 part 5 and TR 023 in the following conditions: **in dry environment at 50 °C during 90 days.**

These tests show an excellent behaviour of the post-installed connection made with HIT-HY 200: low displacements with long term stability, failure load after exposure above reference load.

### Resistance to chemical substances

Chemical	Resistance	Chemical	Resistance
Air	+	Gasoline	+
Acetic acid 10%	+	Glycole	o
Acetone	o	Hydrogen peroxide 10%	o
Ammonia 5%	+	Lactic acid 10%	+
Benzyl alcohol	-	Machinery oil	+
Chloric acid 10%	o	Methylethylketon	o
Chlorinated lime 10%	+	Nitric acid 10%	o
Citric acid 10%	+	Phosphoric acid 10%	+
Concrete plasticizer	+	Potassium Hydroxide pH 13,2	+
De-icing salt (Calcium chloride)	+	Sea water	+
Demineralized water	+	Sewage sludge	+
Diesel fuel	+	Sodium carbonate 10%	+
Drilling dust suspension pH 13,2	+	Sodium hypochlorite 2%	+
Ethanol 96%	-	Sulfuric acid 10%	+
Ethylacetate	-	Sulfuric acid 30%	+
Formic acid 10%	+	Toluene	o
Formwork oil	+	Xylene	o

- + resistant
- o resistant in short term (max. 48h) contact
- not resistant

### Electrical Conductivity

HIT-HY 200 in the hardened state **is not conductive electrically**. Its electric resistivity is  $15,5 \cdot 10^9 \Omega \cdot \text{cm}$  (DIN IEC 93 – 12.93). It is adapted well to realize electrically insulating anchoring (ex: railway applications, subway)

## Setting information

### Installation temperature range

-10°C to +40°C

### Service temperature range

Hilti HIT-HY 200 injection mortar may be applied in the temperature ranges given below. An elevated base material temperature may lead to a reduction of the design bond resistance.

Temperature range	Base material temperature	Maximum long term base material temperature	Maximum short term base material temperature
Temperature range I	-40 °C to +80 °C	+50 °C	+80 °C

### Max short term base material temperature

Short-term elevated base material temperatures are those that occur over brief intervals, e.g. as a result of diurnal cycling.

### Max long term base material temperature

Long-term elevated base material temperatures are roughly constant over significant periods of time.

### Curing and working time

Temperature of the base material	HIT-HY 200-A		HIT-HY 200-R	
	Maximum working time $t_{work}$	Minimum curing time $t_{cure}$	Maximum working time $t_{work}$	Minimum curing time $t_{cure}$
$-10^{\circ}\text{C} < T_{BM} \leq -5^{\circ}\text{C}$	1,5 h	7 h	3 h	20 h
$-5^{\circ}\text{C} < T_{BM} \leq 0^{\circ}\text{C}$	50 min	4 h	2 h	8 h
$0^{\circ}\text{C} < T_{BM} \leq 5^{\circ}\text{C}$	25 min	2 hour	1 h	4 h
$5^{\circ}\text{C} < T_{BM} \leq 10^{\circ}\text{C}$	15 min	75 min	40 min	2,5 h
$10^{\circ}\text{C} < T_{BM} \leq 20^{\circ}\text{C}$	7 min	45 min	15 min	1,5 h
$20^{\circ}\text{C} < T_{BM} \leq 30^{\circ}\text{C}$	4 min	30 min	9 min	1 h
$30^{\circ}\text{C} < T_{BM} \leq 40^{\circ}\text{C}$	3 min	30 min	6 min	1 h

## Setting information

### Installation equipment

Rebar – size	$\phi 8 - \phi 16$	$\phi 18 - \phi 32$
Rotary hammer	TE 2 (-A)– TE 40(-A)	TE40 – TE80
Other tools	Blow out pump ( $h_{ef} \leq 10 \cdot d$ )	-
	Compressed air gun <sup>a)</sup> Set of cleaning brushes <sup>b)</sup> , dispenser, piston plug	

a) Compressed air gun with extension hose for all drill holes deeper than 250 mm (for  $\phi 8$  to  $\phi 12$ ) or deeper than  $20 \cdot \phi$  (for  $\phi > 12$  mm)

b) Automatic brushing with round brush for all drill holes deeper than 250 mm (for  $\phi 8$  to  $\phi 12$ ) or deeper than  $20 \cdot \phi$  (for  $\phi > 12$  mm)

### Minimum concrete cover $c_{min}$ of the post-installed rebar

Drilling method	Bar diameter [mm]	Minimum concrete cover $c_{min}$ [mm]	
		Without drilling aid	With drilling aid
Hammer drilling (HD) and (HDB)	$\phi < 25$	$30 + 0,06 \cdot l_v \geq 2 \cdot \phi$	$30 + 0,02 \cdot l_v \geq 2 \cdot \phi$
	$\phi \geq 25$	$40 + 0,06 \cdot l_v \geq 2 \cdot \phi$	$40 + 0,02 \cdot l_v \geq 2 \cdot \phi$
Compressed air drilling (CA)	$\phi < 25$	$50 + 0,08 \cdot l_v$	$50 + 0,02 \cdot l_v$
	$\phi \geq 25$	$60 + 0,08 \cdot l_v \geq 2 \cdot \phi$	$60 + 0,02 \cdot l_v \geq 2 \cdot \phi$

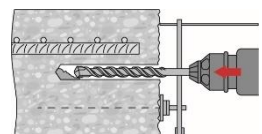

### Drilling and cleaning diameters

Rebar [mm]	Hammer drill (HD)	Hollow Drill Bit (HDB) <sup>b)</sup>	Compressed air drill (CA)	Diamond coring with roughening tool (RT) <sup>b)</sup>	Brush HIT-RB	Air nozzle HIT-RB
	d <sub>0</sub> [mm]				size [mm]	
φ8	12 / 10 <sup>a)</sup>	12	-	-	12 / 10 <sup>a)</sup>	12 / 10 <sup>a)</sup>
φ10	14 / 12 <sup>a)</sup>	14 / 12 <sup>a)</sup>	-	-	14 / 12 <sup>a)</sup>	14 / 12 <sup>a)</sup>
φ12	16 / 14 <sup>a)</sup>	16 / 14 <sup>a)</sup>	-	-	16 / 14 <sup>a)</sup>	16 / 14 <sup>a)</sup>
	-	-	17	-	18	16
φ14	18	18	17	18	18	18
φ16	20	20	-	-	20	20
	-	-	20	20	22	20
φ18	22	22	22	22	22	22
φ20	25	25	-	-	25	25
	-	-	26	25	28	25
φ22	28	28	28	28	28	28
φ24	32	32	32	32	32	32
φ25	32	32	32	32	32	
φ26	35	-	35	35	35	
φ28	35	-	35	35	35	
φ30	-	-	35	-	35	
	37	-	-	37	37	
φ32	40	-	40	40	40	

a) Maximum installation length l=250 mm.

b) No cleaning required

### Associated components for the use of Hilti Roughening tool TE-YRT

Diamond coring		Roughening tool TE-YRT	Wear gauge RTG...
d <sub>0</sub> [mm]		d <sub>0</sub> [mm]	size
Nominal	measured		
18	17,9 to 18,2	18	18
20	19,9 to 20,2	20	20
22	21,9 to 22,2	22	22
25	24,9 to 25,2	25	25
28	27,9 to 28,2	28	28
30	29,9 to 30,2	30	30
32	31,9 to 32,2	32	32
35	34,9 to 35,2	35	35

### Installation parameters for use of the Hilti Roughening tool TE-YRT

h <sub>ef</sub> [mm]	Minimum roughening time t <sub>roughen</sub> [sec] (t <sub>roughen</sub> [sec] = h <sub>ef</sub> [mm] / 10)	Minimum blowing time t <sub>blowing</sub> [sec] (t <sub>blowing</sub> [sec] = t <sub>roughen</sub> [sec] + 20)
0 to 100	10	30
101 to 200	20	40
201 to 300	30	50
301 to 400	40	60
401 to 500	50	70
501 to 600	60	80

Dispensers and corresponding maximum embedment depth  $l_{v,max}$

Rebar	Dispenser	
	HDM 330, HDM 500, HDE 500	HDE 500
	Concrete temp. $\geq -10^{\circ}\text{C}$	Concrete temp. $\geq 0^{\circ}\text{C}$
	$l_{v,max}$ [mm]	$l_{v,max}$ [mm]
$\phi 8 - \phi 32$	700	1000

Setting instructions

\*For detailed information on installation see instruction for use given with the package of the product.



Safety regulations.

Review the Material Safety Data Sheet (MSDS) before use for proper and safe handling! Wear well-fitting protective goggles and protective gloves when working with Hilti HIT-HY 200.

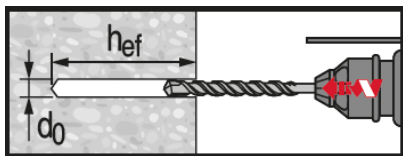

Hammer drilled hole (HD)

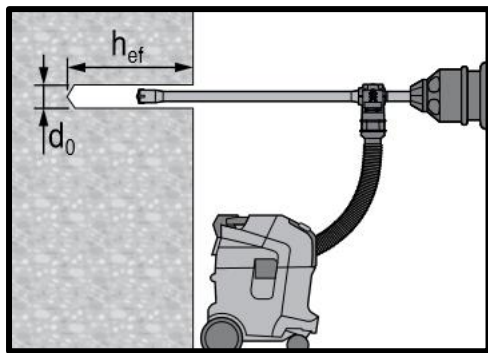

Hammer drilled hole with Hollow Drilled Bit (HDB)

No cleaning required

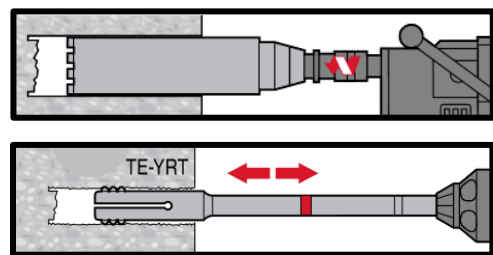

Diamond Drilling + Roughening Tool (DD+RT)

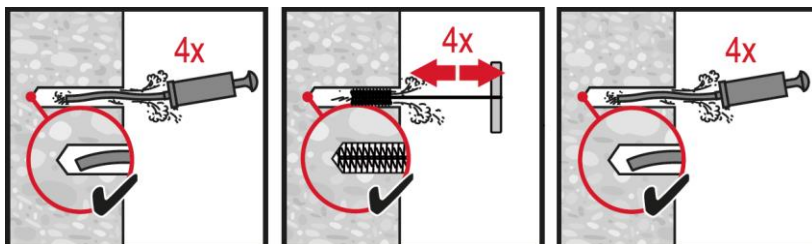

Hammer drilling:

Manual cleaning (MC)

for drill diameters  $d_0 \leq 20$  mm and drill hole depth  $h_0 \leq 10 \cdot d$ .



Hammer drilling:

Compressed air cleaning (CAC)

for all drill hole diameters  $d_0$  and drill hole depths  $h_0 \leq 20 \cdot d$ .

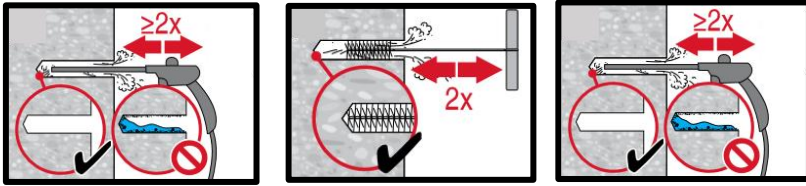

**Diamond cored holes with Hilti roughening tool:**

**Compressed air cleaning (CAC)**  
for all drill hole diameters  $d_0$  and drill hole depths  $h_0$ .

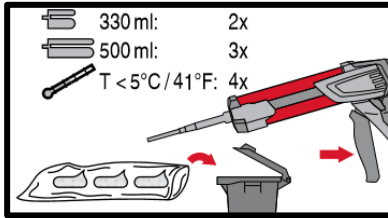
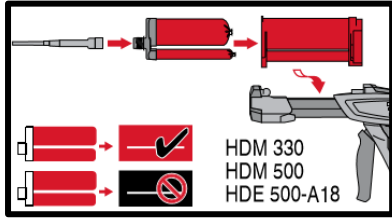

**Injection system preparation.**

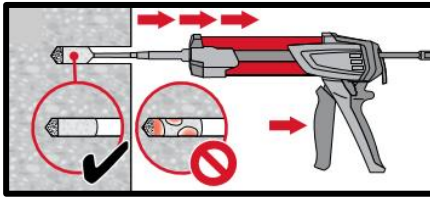
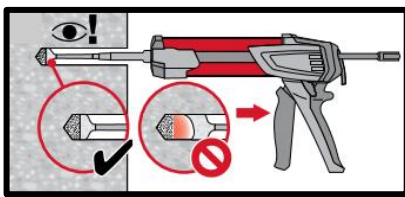

**Injection method for drill hole depth**  
 $h_{ef} \leq 250$  mm.

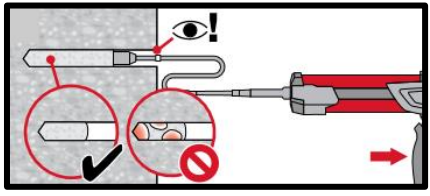
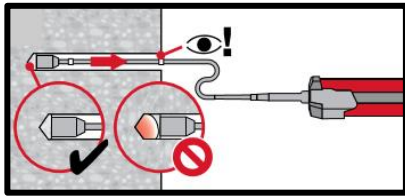

**Injection method for drill hole depth**  
 $h_{ef} > 250$  mm.

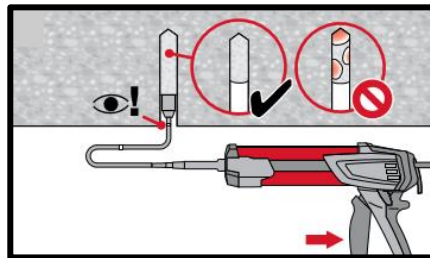
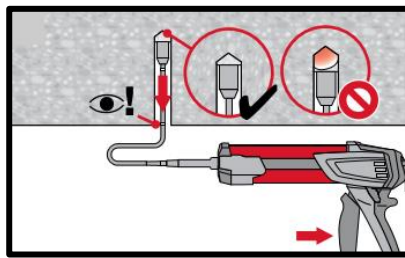

**Injection method for overhead**  
application.

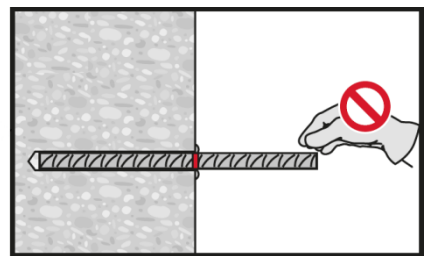
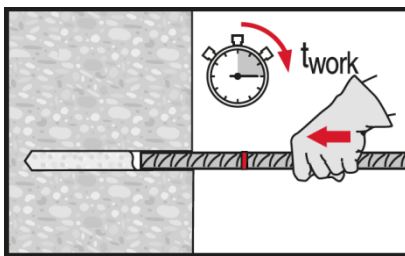

**Setting element, observe working time**  
“ $t_{work}$ ”.

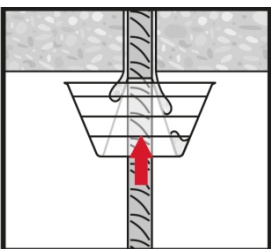
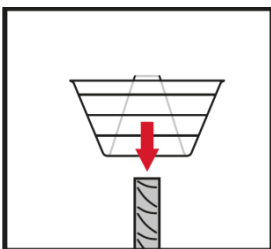
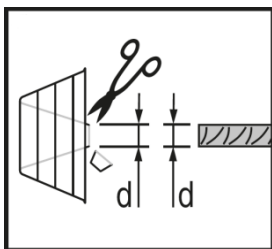

**Setting element for overhead**  
applications, observe working time “ $t_{work}$ ”.

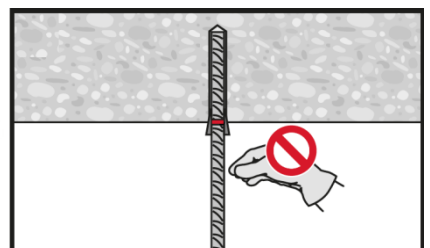
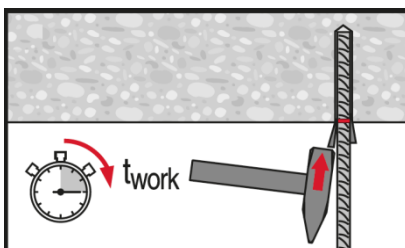

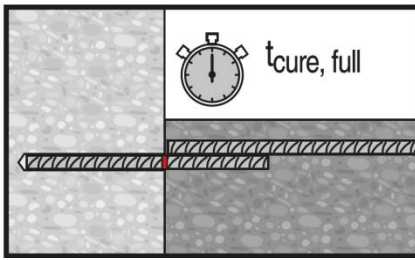
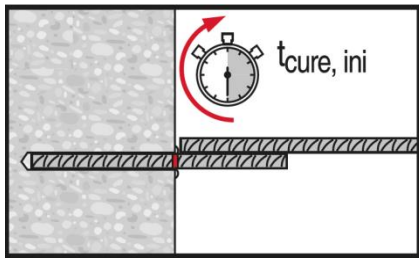

Apply full load only after curing time " $t_{cure}$ ".



# HIT-HY 200-R V3 injection mortar

Anchor design (EN 1992-4) / Rods&Sleeves / Concrete

Concrete

Chemical anchors

Mechanical anchors

Plastic/Light duty metal anchors

Insulation anchors

## Injection mortar system Benefits

	<p>Hilti HIT-HY 200-R V3</p> <p>500 ml foil pack (also available as 330 ml foil pack)</p>	<ul style="list-style-type: none"> <li>- <b>SafeSet</b> technology: Simplified method of borehole preparation using either Hilti hollow drill bit for hammer drilling or Roughening tool for diamond cored applications</li> <li>- Suitable for uncracked and cracked concrete C 20/25 to C 50/60</li> <li>- ETA Approved for seismic performance category C1, C2<sup>a)</sup></li> <li>- Maximum load performance in cracked concrete and uncracked concrete</li> <li>- High corrosion / corrosion resistance<sup>b)</sup></li> <li>- Small edge distance and anchor spacing possible</li> <li>- Manual cleaning for borehole diameter up to 20mm and <math>h_{ef} \leq 10d</math> for uncracked concrete only</li> </ul>
	<p>Anchor rod: HAS-U HAS-U HDG HAS-U A4 HAS-U HCR (M8-M30)</p>	
	<p>Internally threaded sleeve: HIS-N HIS-RN (M8-M20)</p>	

a) HIS-N internally threaded sleeves not approved for Seismic.  
 b) High Corrosion resistant rods available only for HAS-U. Corrosion resistant rods available for HAS-U and HIS-N.

## Base material Installation conditions

Concrete (uncracked)	Concrete (cracked)	Hammer drilled holes	Diamond drilled holes <sup>c)</sup>	Hilti <b>SafeSet</b> technology	Variable embedment depth	Small edge distance and spacing

## Load conditions Other information

Static/quasi-static	Seismic, ETA-C1, C2 <sup>a)</sup>	Fire resistance	European Technical Assessment	CE conformity	Corrosion resistance <sup>b)</sup>	High corrosion resistance <sup>b)</sup>	PROFIS Anchor design Software

a) HIS-N internally threaded sleeves not approved for Seismic.  
 b) High Corrosion resistant rods available only for HAS-U. Corrosion resistant rods available for HAS-U and HIS-N.  
 c) Diamond drilling only with Roughening Tool (RT) for HAS-U and HIS-N.



### Approvals / certificates

Description	Product	Authority /	No. / date of issue
European Technical Assessment <sup>a)</sup>	HY 200-R V3	DIBt, Berlin	ETA-19/0601 / 2019-12-10

a) All data given in this section according to the ETA-19/0601, issue 2019-12-10.

### Static and quasi-static resistance (for a single anchor)

#### All data in this section applies to:

- Correct setting (See setting instruction)
- No edge distance and spacing influence
- Steel failure
- Minimum base material thickness
- One typical embedment depth, as specified in the table
- One anchor material, as specified in the tables
- Concrete C 20/25,  $f_{ck,cube} = 25 \text{ N/mm}^2$
- Temperature range I (min. base material temp.  $-40^\circ\text{C}$ , max. long/short term base material temp.:  $+24^\circ\text{C}/40^\circ\text{C}$ )
- Short term loading. For long term loading please apply  $\psi_{SUS} = 0.74$ .

#### For hammer drilled holes, hammer drilled holes with Hilti hollow drill bit:

#### Anchorage depth <sup>1)</sup>

Anchor size		M8	M10	M12	M16	M20	M24	M27	M30
<b>HAS-U</b>									
Embedment depth	[mm]	80	90	110	125	170	210	240	270
Base material thickness	[mm]	110	120	140	160	220	270	300	340
<b>HIS-N</b>									
Embedment depth	[mm]	90	110	125	170	205	-	-	-
Base material thickness	[mm]	120	150	170	230	270	-	-	-

1) The allowed range of embedment depth is shown in the setting details.

2) For combined pull-out and concrete cone failure

3) For concrete cone failure

#### Characteristic resistance

Anchor size		M8	M10	M12	M16	M20	M24	M27	M30
<b>Uncracked concrete</b>									
Tension $N_{Rk}$	HAS-U 5.8	18,0	29,0	42,0	68,7	109	150	183	218
	HAS-U 8.8	29,0	42,0	56,8	68,7	109	150	183	218
	HAS-U A4	26,0	41,0	56,8	68,7	109	150	183	218
	HAS-U HCR	29,0	42,0	56,8	68,7	109	150	183	218
	HIS-N 8.8	25,0	46,0	67,0	109	116	-	-	-
Shear $V_{Rk}$	HAS-U 5.8	9,0	15,0	21,0	39,0	61,0	88,0	115	140
	HAS-U 8.8	15,0	23,0	34,0	63,0	98,0	141	184	224
	HAS-U A4	13,0	20,0	30,0	55,0	86,0	124	115	140
	HAS-U HCR	15,0	23,0	34,0	63,0	98,0	124	161	196
	HIS-N 8.8	13,0	23,0	34,0	63,0	58,0	-	-	-
<b>Cracked concrete</b>									
Tension $N_{Rk}$	HAS-U 5.8	15,1	21,2	35,2	48,1	76,3	105	128	153
	HAS-U 8.8	15,1	21,2	35,2	48,1	76,3	105	128	153
	HAS-U A4	15,1	21,2	35,2	48,1	76,3	105	128	153
	HAS-U HCR	15,1	21,2	35,2	48,1	76,3	105	128	153
	HIS-N 8.8	24,7	39,7	48,1	76,3	101	-	-	-
Shear $V_{Rk}$	HAS-U 5.8	9,0	15,0	21,0	39,0	61,0	88,0	115	140
	HAS-U 8.8	15,0	23,0	34,0	63,0	98,0	141	184	224
	HAS-U A4	13,0	20,0	30,0	55,0	86,0	124	115	140
	HAS-U HCR	15,0	23,0	34,0	63,0	98,0	124	161	196
	HIS-N 8.8	13,0	23,0	34,0	63,0	58,0	-	-	-

### Design resistance

Anchor size		M8	M10	M12	M16	M20	M24	M27	M30
<b>Uncracked concrete</b>									
Tension $N_{Rd}$	HAS-U 5.8	12,0	19,3	28,0	45,8	72,7	99,8	122	146
	HAS-U 8.8	19,3	28,0	37,8	45,8	72,7	99,8	122	146
	HAS-U A4 [kN]	13,9	21,9	31,6	45,8	72,7	99,8	80,4	98,3
	HAS-U HCR	19,3	28,0	37,8	45,8	72,7	99,8	122	146
	HIS-N 8.8	16,7	30,7	44,7	72,7	77,3	-	-	-
Shear $V_{Rd}$	HAS-U 5.8	7,2	12,0	16,8	31,2	48,8	70,4	92,0	112
	HAS-U 8.8	12,0	18,4	27,2	50,4	78,4	113	147	179
	HAS-U A4 [kN]	8,3	12,8	19,2	35,3	55,1	79,5	48,3	58,8
	HAS-U HCR	12,0	18,4	27,2	50,4	78,4	70,9	92,0	112
	HIS-N 8.8	10,4	18,4	27,2	50,4	46,4	-	-	-
<b>Cracked concrete</b>									
Tension $N_{Rd}$	HAS-U 5.8	10,1	14,1	23,5	32,1	50,9	69,9	85,4	102
	HAS-U 8.8	10,1	14,1	23,5	32,1	50,9	69,9	85,4	102
	HAS-U A4 [kN]	10,1	14,1	23,5	32,1	50,9	69,9	80,4	98,3
	HAS-U HCR	10,1	14,1	23,5	32,1	50,9	69,9	85,4	102
	HIS-N 8.8	16,5	26,5	32,1	50,9	67,4	-	-	-
Shear $V_{Rd}$	HAS-U 5.8	7,2	12,0	16,8	31,2	48,8	70,4	92,0	112
	HAS-U 8.8	12,0	18,4	27,2	50,4	78,4	113	147	179
	HAS-U A4 [kN]	8,3	12,8	19,2	35,3	55,1	79,5	48,3	58,8
	HAS-U HCR	12,0	18,4	27,2	50,4	78,4	70,9	92,0	112
	HIS-N 8.8	10,4	18,4	27,2	50,4	46,4	-	-	-

### Seismic resistance (for a single anchor)

#### All data in this section applies to:

- Correct setting (See setting instruction with hammer drilling)
- No edge distance and spacing influence
- Steel failure
- Minimum base material thickness
- Concrete C 20/25,  $f_{ck,cube} = 25 \text{ N/mm}^2$
- Temperature range I (min. base material temp.  $-40^\circ\text{C}$ , max. long/short term base material temp.:  $+24^\circ\text{C}/40^\circ\text{C}$ )
- Installation temperature range  $-10^\circ\text{C}$  to  $+40^\circ\text{C}$
- $\alpha_{gap} = 1,0$  (using Hilti seismic filling set)

For hammer drilled holes and hammer drilled holes with Hilti hollow drill bit:

#### Anchorage depth for seismic C2

Anchor size		M8	M10	M12	M16	M20	M24	M27	M30
<b>HAS-U</b>									
Embedment depth	$h_{ef}$ [mm]	-	-	-	125	170	210	-	-

#### Characteristic resistance in case of seismic performance category C2

Anchor size		M8	M10	M12	M16	M20	M24	M27	M30
Tension $N_{Rk,seis}$	HAS-U 8.8 [kN]	-	-	-	24,5	45,9	55,4	-	-
Shear $V_{Rk,seis}$	HAS-U 8.8 w/ filling set [kN]	-	-	-	46,0	77,0	103	-	-
	HAS-U 8.8 w/o filling set [kN]	-	-	-	40,0	71,0	90,0	-	-

#### Design resistance in case of seismic performance category C2

Anchor size		M8	M10	M12	M16	M20	M24	M27	M30
Tension $N_{Rd,seis}$	HAS-U 8.8 [kN]	-	-	-	16,3	30,6	36,9	-	-
Shear $V_{Rd,seis}$	HAS-U 8.8 w/ filling set [kN]	-	-	-	36,8	61,6	82,4	-	-
	HAS-U 8.8 w/o filling set [kN]	-	-	-	32,0	56,8	72,0	-	-

### Anchorage depth for seismic C1

Anchor size			M8	M10	M12	M16	M20	M24	M27	M30
<b>HAS-U</b>										
Embedment depth	$h_{ef}$	[mm]	-	90	110	125	170	210	240	270

### Characteristic resistance in case of seismic performance category C1

Anchor size			M8	M10	M12	M16	M20	M24	M27	M30
Tension $N_{Rk,seis}$	HAS-U 8.8	[kN]	-	14,7	29,0	44,0	72,5	99,6	122	145
Shear $V_{Rk,seis}$	HAS-U 8.8	[kN]	-	23,0	34,0	63,0	98,0	141	184	224

### Design resistance in case of seismic performance category C1

Anchor size			M8	M10	M12	M16	M20	M24	M27	M30
Tension $N_{Rd,seis}$	HAS-U 8.8	[kN]	-	9,8	19,4	29,3	48,4	66,4	81,1	96,8
Shear $V_{Rd,seis}$	HAS-U 8.8	[kN]	-	18,4	27,2	50,4	78,4	113	145	173

### Materials

#### Mechanical properties for HAS-U

Anchor size			M8	M10	M12	M16	M20	M24	M27	M30
Nominal tensile strength $f_{uk}$	HAS-U 5.8 (HDG)	[N/mm <sup>2</sup> ]	500	500	500	500	500	500	-	-
	HAS-U 8.8 (HDG)		800	800	800	800	800	800	800	800
	AM 8.8 (HDG)		700	700	700	700	700	700	500	500
	HAS-U A4		800	800	800	800	800	700	-	-
Yield strength $f_{yk}$	HAS-U 5.8 (HDG)	[N/mm <sup>2</sup> ]	440	440	440	440	400	400	-	-
	HAS-U 8.8 (HDG)		640	640	640	640	640	640	640	640
	AM 8.8 (HDG)		450	450	450	450	450	450	210	210
	HAS-U A4		640	640	640	640	640	400	-	-
Stressed cross-section $A_s$	HAS-U	[mm <sup>2</sup> ]	36,6	58,0	84,3	157	245	353	459	561
Moment of resistance $W$	HAS-U	[mm <sup>3</sup> ]	31,2	62,3	109	277	541	935	1387	1874

#### Mechanical properties for HIS-N

Anchor size			M8	M10	M12	M16	M20
Nominal tensile strength $f_{uk}$	HIS-N	[N/mm <sup>2</sup> ]	490	490	490	490	490
	Screw 8.8		800	800	800	800	800
	HIS-RN		700	700	700	700	700
	Screw 70		700	700	700	700	700
Yield strength $f_{yk}$	HIS-N	[N/mm <sup>2</sup> ]	390	390	390	390	390
	Screw 8.8		640	640	640	640	640
	HIS-RN		350	350	350	350	350
	Screw A4-70		450	450	450	450	450
Stressed cross-section $A_s$	HIS-(R)N	[mm <sup>2</sup> ]	51,5	108	169	256	238
	Screw		36,6	58,0	84,3	157	245
Moment of resistance $W$	HIS-(R)N	[mm <sup>3</sup> ]	145	430	840	1595	1543
	Screw		31,2	62,3	109	277	541

### Material quality for HAS-U

Part	Material
<b>Zinc coated steel</b>	
Threaded rod, HAS-U 5.8 (HDG)	Strength class 5.8; Elongation at fracture A5 > 8% ductile Electroplated zinc coated $\geq 5\mu\text{m}$ ; (HDG) hot dip galvanized $\geq 45\mu\text{m}$
Threaded rod, HAS-U 8.8 (HDG)	Strength class 8.8; Elongation at fracture A5 > 12% ductile Electroplated zinc coated $\geq 5\mu\text{m}$ ; (HDG) hot dip galvanized $\geq 45\mu\text{m}$
Hilti Meter rod, AM 8.8 (HDG)	Strength class 8.8; Elongation at fracture A5 > 12% ductile Electroplated zinc coated $\geq 5\mu\text{m}$ , (HDG) hot dip galvanized $\geq 45\mu\text{m}$
Washer	Electroplated zinc coated $\geq 5\mu\text{m}$ , hot dip galvanized $\geq 45\mu\text{m}$
Nut	Strength class of nut adapted to strength class of threaded rod. Electroplated zinc coated $\geq 5\mu\text{m}$ , (HDG) hot dip galvanized $\geq 45\mu\text{m}$
Hilti Filling set (F)	Filling washer: Electroplated zinc coated $\geq 5\mu\text{m}$ / (HDG) Hot dip galvanized $\geq 45\mu\text{m}$ Spherical washer: Electroplated zinc coated $\geq 5\mu\text{m}$ / (HDG) Hot dip galvanized $\geq 45\mu\text{m}$ Lock nut: Electroplated zinc coated $\geq 5\mu\text{m}$ / (HDG) Hot dip galvanized $\geq 45\mu\text{m}$
<b>Stainless Steel</b>	
Threaded rod, HAS-U A4	Strength class 70 for $\leq M24$ and strength class 50 for $> M24$ ; Elongation at fracture A5 > 8% ductile Stainless steel 1.4401; 1.4404; 1.4578; 1.4571; 1.4439; 1.4362 EN 10088-1:2014
Washer	Stainless steel 1.4401, 1.4404, 1.4578, 1.4571, 1.4439, 1.4362 EN 10088-1:2014
Nut	Strength class 70 for $\leq M24$ and strength class 50 for $> M24$ ; Stainless steel 1.4401, 1.4404, 1.4578, 1.4571, 1.4439, 1.4362 EN 10088-1:2014
<b>High corrosion resistant steel</b>	
Threaded rod, HAS-U HCR	Strength class 80 for $\leq M20$ and class 70 for $> M20$ , Elongation at fracture A5 > 8% ductile High corrosion resistant steel 1.4529, 1.4565 EN 10088-1:2014
Washer	High corrosion resistant steel 1.4529, 1.4565 EN 10088-1:2014
Nut	Strength class 80 for $\leq M20$ and class 70 for $> M20$ , High corrosion resistant steel 1.4529, 1.4565 EN 10088-1:2014

### Material quality for HIS-N

Part	Material
HIS-N Int. threaded sleeve	Electroplated zinc coated $\geq 5\mu\text{m}$
HIS-RN Int. threaded sleeve	Stainless steel 1.4401, 1.4571 EN 10088-1:2014

## Setting information

### In service temperature range

Hilti HIT-HY 200-R V3 injection mortar with anchor rod HAS-U / HIS-(R)N may be applied in the temperature ranges given below. An elevated base material temperature leads to a reduction of the design bond resistance.

### Temperature in the base material

Temperature range	Base material temperature	Maximum long term base material temperature	Maximum short term base material temperature
Temperature range I	-40 °C to +40 °C	+24 °C	+40 °C
Temperature range II	-40 °C to +80 °C	+50 °C	+80 °C
Temperature range III	-40 °C to +120 °C	+72 °C	+120 °C

### Max short term base material temperature

Short-term elevated base material temperatures are those that occur over brief intervals, e.g. as a result of diurnal cycling.

### Max long term base material temperature

Long-term elevated base material temperatures are roughly constant over significant periods of time.

### Curing and working time

Temperature of the base material	HIT-HY 200-R V3	
	Maximum working time $t_{work}$	Minimum curing time $t_{cure}$
$-10^{\circ}\text{C} < T_{BM} \leq -5^{\circ}\text{C}$	3 h	20 h
$-5^{\circ}\text{C} < T_{BM} \leq 0^{\circ}\text{C}$	1,5 h	8 h
$0^{\circ}\text{C} < T_{BM} \leq 5^{\circ}\text{C}$	45 min	4 h
$5^{\circ}\text{C} < T_{BM} \leq 10^{\circ}\text{C}$	30 min	2,5 h
$10^{\circ}\text{C} < T_{BM} \leq 20^{\circ}\text{C}$	15 min	1,5 h
$20^{\circ}\text{C} < T_{BM} \leq 30^{\circ}\text{C}$	9 min	1 h
$30^{\circ}\text{C} < T_{BM} \leq 40^{\circ}\text{C}$	6 min	1 h

### Setting details for HAS-U

Anchor size	M8	M10	M12	M16	M20	M24	M27	M30	
Nominal diameter of drill bit $d_0$ [mm]	10	12	14	18	22	28	30	35	
Eff. embedment depth and drill hole depth <sup>a)</sup>	$h_{ef,min}$ [mm]	60	60	70	80	90	96	108	120
	$h_{ef,max}$ [mm]	160	200	240	320	400	480	540	600
Minimum base material thickness $h_{min}$ [mm]	$h_{ef} + 30 \text{ mm} \geq 100 \text{ mm}$			$h_{ef} + 2 d_0$					
Maximum diameter of clearance hole in the fixture $d_f$ [mm]	9	12	14	18	22	26	30	33	
Thickness of Hilti filling set $h_{fs}$ [mm]	-	-	-	11	13	15	-	-	
Effective fixture thickness with Hilti filling set $t_{fix,eff}$ [mm]	$t_{fix} - h_{fs}$								
Max. torque moment <sup>b)</sup> $T_{max}$ [Nm]	10	20	40	80	150	200	270	300	
Minimum spacing $s_{min}$ [mm]	40	50	60	75	90	115	120	140	
Minimum edge distance $c_{min}$ [mm]	40	45	45	50	55	60	75	80	
Critical spacing for splitting failure $s_{cr,sp}$ [mm]	$2 C_{cr,sp}$								
Critical edge distance for splitting failure <sup>c)</sup> $c_{cr,sp}$ [mm]	$1,0 \cdot h_{ef}$ for $h / h_{ef} \geq 2,00$								
	$4,6 h_{ef} - 1,8 h$ for $2,00 > h / h_{ef} > 1,3$								
	$2,26 h_{ef}$ for $h / h_{ef} \leq 1,3$								
Critical spacing for concrete cone failure $s_{cr,N}$ [mm]	$2 C_{cr,sp}$								
Critical edge distance for concrete cone failure <sup>d)</sup> $c_{cr,N}$ [mm]	$1,5 h_{ef}$								

For spacing (edge distance) smaller than critical spacing (critical edge distance) the design loads have to be reduced.

- a)  $h_{ef,min} \leq h_{ef} \leq h_{ef,max}$  ( $h_{ef}$ : embedment depth)
- b) Maximum recommended torque moment to avoid splitting failure during installation with minimum spacing and edge distance
- c)  $h$ : base material thickness ( $h \geq h_{min}$ )
- d) The critical edge distance for concrete cone failure depends on the embedment depth  $h_{ef}$  and the design bond resistance. The simplified formula given in this table is on the safe side.

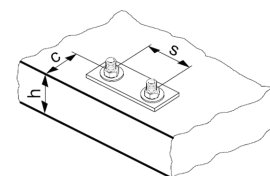

HAS-U-...



#### Marking:

Steel grade number and length identification letter: e.g. 8L

### Setting details for HIS-N

Anchor size		M8	M10	M12	M16	M20
Nominal diameter of drill bit $d_0$	[mm]	14	18	22	28	32
Diameter of element $d$	[mm]	12,5	16,5	20,5	25,4	27,6
Effective anchorage and drill hole depth $h_{ef}$	[mm]	90	110	125	170	205
Minimum base material thickness $h_{min}$	[mm]	120	150	170	230	270
Diameter of clearance hole in the fixture $d_f$	[mm]	9	12	14	18	22
Thread engagement length; min - max $h_s$	[mm]	8-20	10-25	12-30	16-40	20-50
Minimum spacing $s_{min}$	[mm]	60	75	90	115	130
Minimum edge distance $c_{min}$	[mm]	40	45	55	65	90
Critical spacing for splitting failure $s_{cr,sp}$	[mm]	$2 C_{cr,sp}$				
Critical edge distance for splitting failure <sup>b)</sup> $c_{cr,sp}$	[mm]	$1,0 \cdot h_{ef}$ for $h / h_{ef} \geq 2,0$				
		$4,6 h_{ef} - 1,8 h$ for $2,0 > h / h_{ef} > 1,3$				
		$2,26 h_{ef}$ for $h / h_{ef} \leq 1,3$				
Critical spacing for concrete cone failure $s_{cr,N}$	[mm]	$2 C_{cr,N}$				
Critical edge distance for concrete cone failure <sup>c)</sup> $c_{cr,N}$	[mm]	$1,5 h_{ef}$				
Max. torque moment <sup>a)</sup> $T_{max}$	[Nm]	10	20	40	80	150

For spacing (edge distance) smaller than critical spacing (critical edge distance) the design loads have to be reduced.

- a) Max. recommended torque moment to avoid splitting failure during installation with minimum spacing and edge distance
- b)  $h$ : base material thickness ( $h \geq h_{min}$ )
- c) The critical edge distance for concrete cone failure depends on the embedment depth  $h_{ef}$  and the design bond resistance. The simplified formula given in this table is on the safe side.

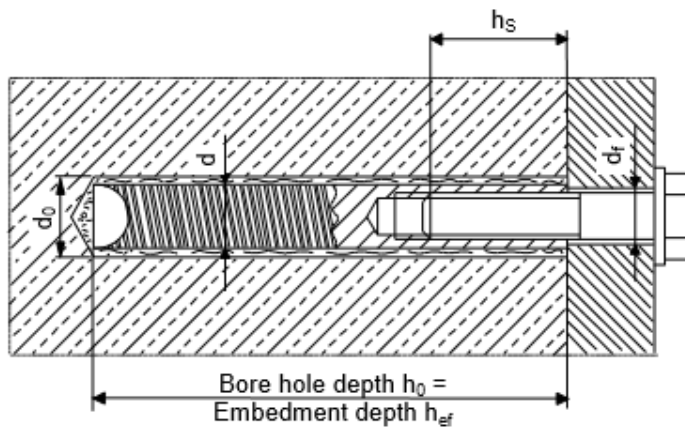
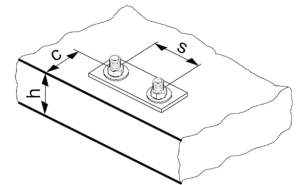



### Installation equipment

Anchor size	M8	M10	M12	M16	M20	M24	M27	M30
Rotary hammer	HAS-U	TE 2 – TE 16			TE 40 - TE 80			
	HIS-N	TE (-A) – TE 16(-A)		TE 40 – TE 80		-		
Other tools	compressed air gun and blow out pump, set of cleaning brushes, dispenser Hollow Drill Bit							
	roughening tools TE-YRT							
Additional Hilti recommended tools	DD EC-1, DD 100 ... DD 160 <sup>a)</sup>							

a) For anchors in diamond drilled holes load values for combined pull-out and concrete cone resistance have to be reduced

### Cleaning, drilling and installation parameters

HAS-U	HIS-N	Drill bit diameters d <sub>0</sub> [mm]				Cleaning and installation	
		Hammer drill (HD)	Hollow Drill Bit (HDB)	Diamond coring		Brush HIT-RB	Piston plug HIT-SZ
				Diamond coring (DD)	With roughening tool (RT)		
<b>M8</b>	-	10	-	-	-	10	-
<b>M10</b>	-	12	12	-	-	12	12
<b>M12</b>	<b>M8</b>	14	14	-	-	14	14
<b>M16</b>	<b>M10</b>	18	18	18	18	18	18
<b>M20</b>	<b>M12</b>	22	22	22	22	22	22
<b>M24</b>	<b>M16</b>	28	28	28	28	28	28
<b>M27</b>	-	30	-	-	-	30	30
-	<b>M20</b>	32	32	32	32	32	32
<b>M30</b>	-	35	35	35	35	35	35

### Associated components for the use of Hilti Roughening tool TE-YRT

Diamond coring		Roughening tool TE-YRT	Wear gauge RTG...
d <sub>0</sub> [mm]		d <sub>0</sub> [mm]	size
Nominal	measured		
18	17,9 to 18,2	18	18
20	19,9 to 20,2	20	20
22	21,9 to 22,2	22	22
25	24,9 to 25,2	25	25
28	27,9 to 28,2	28	28
30	29,9 to 30,2	30	30
32	31,9 to 32,2	32	32
35	34,9 to 35,2	35	35

### Installation parameters for use of the Hilti Roughening tool TE-YRT

h <sub>ef</sub> [mm]	Minimum roughening time t <sub>roughen</sub> [sec] (t <sub>roughen</sub> [sec] = h <sub>ef</sub> [mm] / 10)	Minimum blowing time t <sub>blowing</sub> [sec] (t <sub>blowing</sub> [sec] = t <sub>roughen</sub> [sec] + 20)
0 to 100	10	30
101 to 200	20	40
201 to 300	30	50
301 to 400	40	60
401 to 500	50	70
501 to 600	60	80



## Setting instructions for HAS-U rods and HIS-N internally threaded sleeves

\*For detailed information on installation see instruction for use given with the package of the product



### Safety regulations.

Review the Material Safety Data Sheet (MSDS) before use for proper and safe handling! Wear well-fitting protective goggles and protective gloves when working with Hilti HIT-HY 200-R V3.

### Drilling

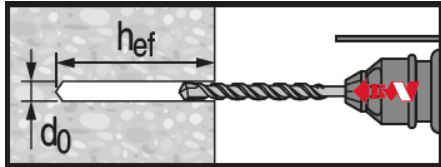

Hammer drilled hole (HD)

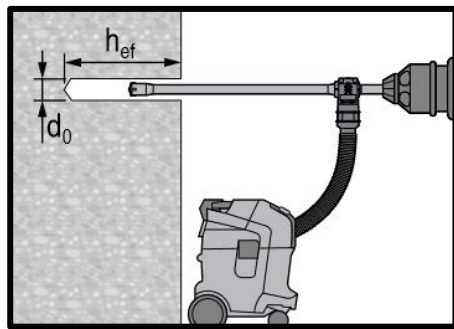

Hammer drilled hole with Hollow Drilled Bit (HDB)

No cleaning required

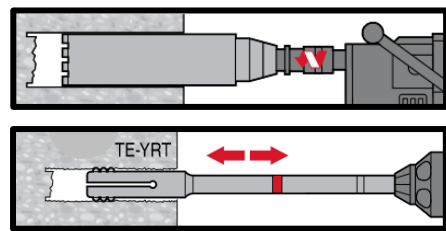

Diamond Drilling + Roughening Tool (DD+RT)

### Cleaning

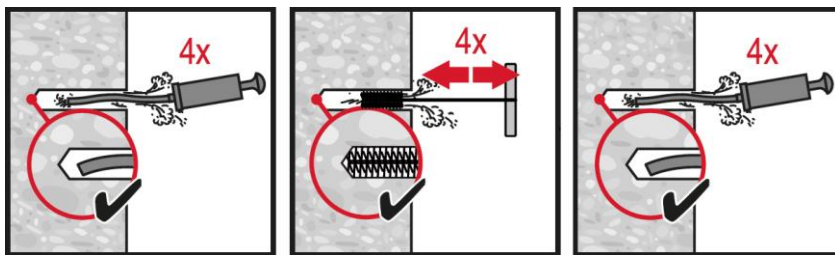

#### Hammer drilling:

#### Manual cleaning (MC)

for drill diameters  $d_0 \leq 20$  mm and drill hole depth  $h_0 \leq 10 \cdot d$ .

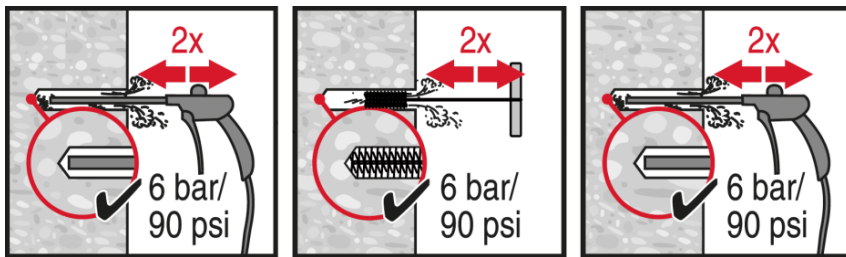

#### Hammer drilling:

#### Compressed air cleaning (CAC)

for all drill hole diameters  $d_0$  and drill hole depths  $h_0 \leq 20 \cdot d$ .

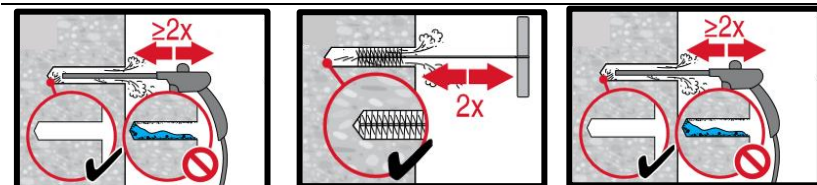

#### Diamond cored holes with Hilti roughening tool:

#### Compressed air cleaning (CAC)

for all drill hole diameters  $d_0$  and drill hole depths  $h_0$ .

## Injection

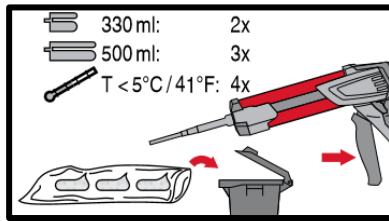
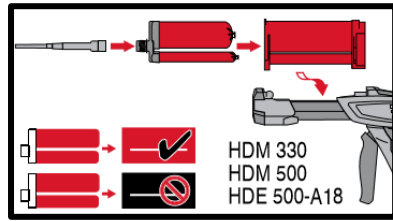

**Injection system preparation.**

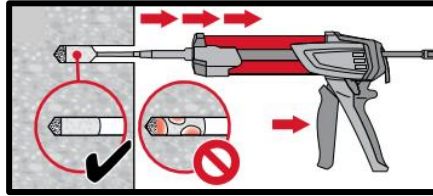
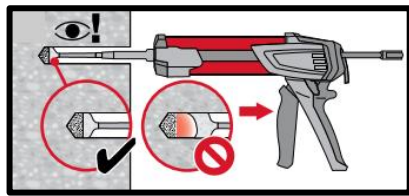

**Injection method for drill hole depth**  
 $h_{ef} \leq 250 \text{ mm}$ .

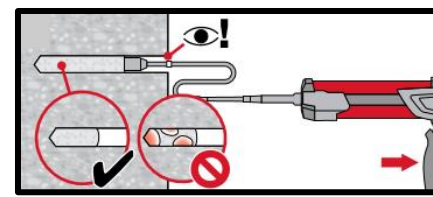
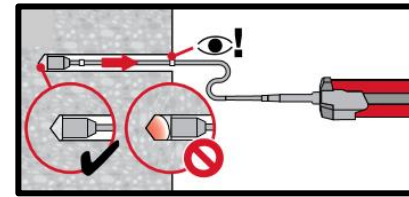

**Injection method for drill hole depth**  
 $h_{ef} > 250 \text{ mm}$ .

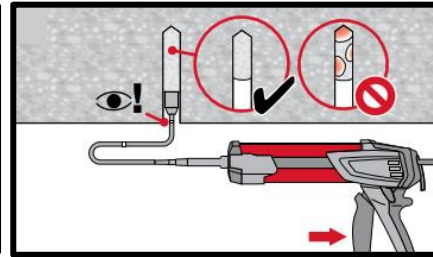
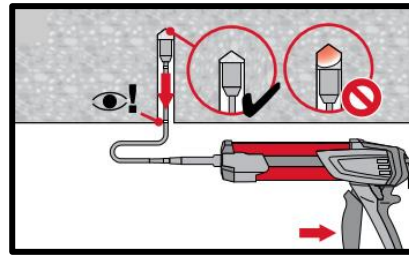

**Injection method for overhead**  
application and/or installation with  
embedment depth > 250 mm.

## Setting the element

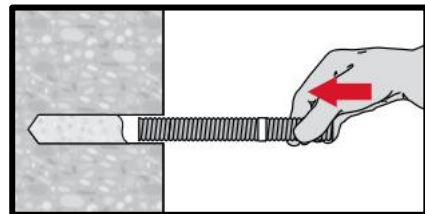

**Setting element**, observe working time  
“ $t_{work}$ ”.

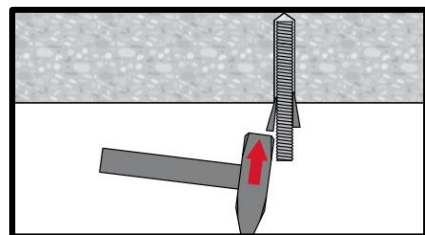

**Setting element for overhead**  
applications, observe working time “ $t_{work}$ ”.

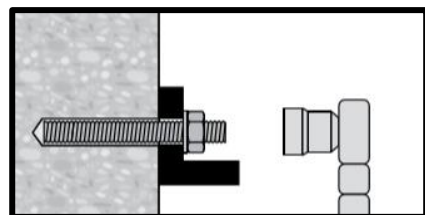

**Loading the anchor** after required  
curing time  $t_{cure}$



Concrete

Chemical anchors

Mechanical anchors

Plastic/Light duty metal anchors

Insulation anchors

# HIT-HY 200-R V3 injection mortar

Anchor design (EN 1992-4) / Rebar elements / Concrete

Concrete

Chemical anchors

Mechanical anchors

Plastic/Light duty metal anchors

Insulation anchors

## Injection mortar system



Hilti HIT-HY 200-R V3

330 ml foil pack  
(also available as 500 ml foil pack)



Rebar B500 B  
( $\phi 8 - \phi 32$ )

## Benefits

- **SafeSet** technology: Simplified method of borehole preparation using either Hilti hollow drill bit for hammer drilling or Roughening tool for diamond cored applications
- Assessed following the EAD 332402-00-0601 "Post-Installed Reinforcing Bar (Rebar) Connections with Improved Bond-Splitting Behavior Under Static Loading".
- Allows the design of post-installed, moment-resisting reinforced concrete connections under static loading conditions without using a splice configuration according to TR 069
- ETA seismic approval C1
- Suitable for cracked and uncracked concrete C 12/15 to C 50/60
- Suitable for dry and water saturated concrete
- In service temperature range up to 120°C short term / 72°C long term
- Large diameter applications

## Base material



Concrete (uncracked)



Concrete (cracked)



Dry concrete



Wet concrete



Static/  
quasi-static



Seismic,  
ETA-C1



Fire  
resistance

## Load conditions

## Installation conditions

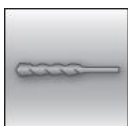

Hammer  
drilling



Diamond  
drilled  
holes<sup>a)</sup>

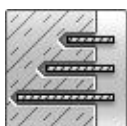

Variable  
embedment  
depth

**SAFESET**

Hilti **SafeSet**  
technology



Small edge  
distance and  
spacing



European  
Technical  
Assessment



CE  
conformity



PROFIS  
Rebar design  
Software

## Other informations

## Approvals / certificates

Description	Authority / Laboratory	No. / date of issue
European technical assessment <sup>a)</sup>	DIBt, Berlin	ETA-19/0601 / 2019-12-10

a) All data given in this section according to ETA-19/0601 issue 2019-12-10.

## Static and quasi-static loading (for a single anchor)

### All data in this section applies to

- Correct setting (See setting instruction)
- No edge distance and spacing influence
- Steel failure
- Base material thickness, as specified in the table
- One typical embedment depth, as specified in the table
- One anchor material, as specified in the tables
- Concrete C 20/25,  $f_{ck,cube} = 25 \text{ N/mm}^2$
- Temperature range I  
(min. base material temperature  $-40^\circ\text{C}$ , max. long term/short term base material temperature:  $+24^\circ\text{C}/40^\circ\text{C}$ )

### Embedment depth and base material thickness for static and quasi-static loading data

Anchor size	$\phi 8$	$\phi 10$	$\phi 12$	$\phi 14$	$\phi 16$	$\phi 20$	$\phi 25$	$\phi 26$	$\phi 28$	$\phi 30$	$\phi 32$
Typical embedment depth [mm]	80	90	110	125	125	170	210	240	270	270	300
Base material thickness [mm]	110	120	140	160	170	220	280	310	340	350	380

### Characteristic resistance

Anchor size	$\phi 8$	$\phi 10$	$\phi 12$	$\phi 14$	$\phi 16$	$\phi 20$	$\phi 25$	$\phi 26$	$\phi 28$	$\phi 30$	$\phi 32$
<b>Uncracked concrete</b>											
Tensile $N_{Rk}$	24,1	33,9	49,8	66,0	68,7	109	150	183	218	218	256
Shear $V_{Rk}$	14,0	22,0	31,0	42,0	55,0	86,0	135	146	169	194	221
<b>Cracked concrete</b>											
Tensile $N_{Rk}$	-	14,1	29,0	38,5	44,0	74,8	105	128	153	153	179
Shear $V_{Rk}$	-	22,0	31,0	42,0	55,0	86,0	135	146	169	194	221

### Design resistance

Anchor size	$\phi 8$	$\phi 10$	$\phi 12$	$\phi 14$	$\phi 16$	$\phi 20$	$\phi 25$	$\phi 26$	$\phi 28$	$\phi 30$	$\phi 32$
<b>Uncracked concrete</b>											
Tensile $N_{Rd}$	16,1	22,6	33,2	44,0	45,8	72,7	99,8	122	146	146	170
Shear $V_{Rd}$	9,3	14,7	20,7	28,0	36,7	57,3	90,0	97,3	113	129	147
<b>Cracked concrete</b>											
Tensile $N_{Rd}$	-	9,4	19,4	25,7	29,3	49,8	69,9	85,4	102	102	119
Shear $V_{Rd}$	-	14,7	20,7	28,0	36,7	57,3	90,0	97,3	113	129	147

## Seismic loading (for a single anchor)

### All data in this section applies to:

- Correct setting (See setting)
- No edge distance and spacing influence
- Steel failure
- Minimum base material thickness
- Concrete C 20/25,  $f_{ck,cube} = 25 \text{ N/mm}^2$
- Temperature range I  
(min, base material temperature  $-40^\circ\text{C}$ , max, long term/short term base material temperature:  $+24^\circ\text{C}/40^\circ\text{C}$ )
- $\alpha_{gap} = 1,0$

### Embedment depth and base material thickness in case of seismic performance category C1

Anchor size	$\phi 8$	$\phi 10$	$\phi 12$	$\phi 14$	$\phi 16$	$\phi 20$	$\phi 25$	$\phi 26$	$\phi 28$	$\phi 30$	$\phi 32$
Typical embedment depth [mm]	-	90	110	125	125	170	210	240	270	270	300
Base material thickness [mm]	-	120	140	160	170	220	280	310	340	350	380

### Characteristic resistance in case of seismic performance category C1

Anchor size	$\phi 8$	$\phi 10$	$\phi 12$	$\phi 14$	$\phi 16$	$\phi 20$	$\phi 25$	$\phi 26$	$\phi 28$	$\phi 30$	$\phi 32$
Tensile $N_{Rk, se}$	-	12,4	25,3	33,5	38,3	65,2	99,6	120	145	145	170
Shear $V_{Rk, se}$	-	15,0	22,0	29,0	39,0	60,0	95,0	102	118	136	155

### Design resistance in case of seismic performance category C1

Anchor size	$\phi 8$	$\phi 10$	$\phi 12$	$\phi 14$	$\phi 16$	$\phi 20$	$\phi 25$	$\phi 26$	$\phi 28$	$\phi 30$	$\phi 32$
Tensile $N_{Rd, se}$	-	8,3	16,9	22,4	25,6	43,4	66,4	79,7	96,6	96,8	113
Shear $V_{Rd, se}$	-	10,0	14,7	19,3	26,0	40,0	63,3	68,0	78,7	90,7	103

## Materials

### Mechanical properties

Anchor size	$\phi 8$	$\phi 10$	$\phi 12$	$\phi 14$	$\phi 16$	$\phi 20$	$\phi 25$	$\phi 26$	$\phi 28$	$\phi 30$	$\phi 32$
Nominal tensile strength $f_{uk}$ [N/mm <sup>2</sup> ]	550	550	550	550	550	550	550	550	550	550	550
Yield strength $f_{yk}$ [N/mm <sup>2</sup> ]	500	500	500	500	500	500	500	550	500	550	500
Stressed cross-section $A_s$ [mm <sup>2</sup> ]	50,3	78,5	113	154	201	314	491	531	616	707	804
Moment of resistance $W$ [mm <sup>3</sup> ]	50,3	98,2	170	269	402	785	1534	1726	2155	2651	3217

### Material quality

Part	Material
Rebar EN 1992-1-1:2004 and AC:2010	Bars and de-coiled rods class B or C according to NDP or NCL of EN 1992-1-1/NA

## Setting information

### Installation temperature range

- 10°C to + 40°C

### Service temperature range

Hilti HIT-HY 200-R V3 injection mortar may be applied in the temperature ranges given below, An elevated base material temperature may lead to a reduction of the design bond resistance.

Temperature range	Base material temperature	Max, long term base material temperature	Max, short term base material temperature
Temperature range I	-40 °C to + 40 °C	+ 24 °C	+ 40 °C
Temperature range II	-40 °C to + 80 °C	+ 50 °C	+ 80 °C
Temperature range III	-40 °C to + 120 °C	+ 72 °C	+ 120 °C

### Max, short term base material temperature

Short term elevated base material temperatures are those that occur over brief intervals, e.g, as a result of diurnal cycling.

### Max, long term base material temperature

Long term elevated base material temperatures are roughly constant over significant periods of time.

### Curing and working time

Temperature of the base material	HIT-HY 200-R	
	Maximum working time	minimum curing time
	$t_{work}$	$t_{cure}$
- 10°C < $T_{BM} \leq - 5^\circ\text{C}$	3 h	20 h
- 5°C < $T_{BM} \leq 0^\circ\text{C}$	1,5 h	8 h
0°C < $T_{BM} \leq 5^\circ\text{C}$	45 min	4 h
5°C < $T_{BM} \leq 10^\circ\text{C}$	30 min	2,5 h
10°C < $T_{BM} \leq 20^\circ\text{C}$	15 min	1,5 h
20°C < $T_{BM} \leq 30^\circ\text{C}$	9 min	1 h
30°C < $T_{BM} \leq 40^\circ\text{C}$	6 min	1 h

### Installation equipment

Anchor size	$\phi 8$	$\phi 10$	$\phi 12$	$\phi 14$	$\phi 16$	$\phi 20$	$\phi 25$	$\phi 26$	$\phi 28$	$\phi 30$	$\phi 32$
Rotary hammer	TE 2 (-A) – TE 16 (-A)					TE 40 – TE 80					
Other tools	Compressed air gun, blow out pump Set of cleaning brushes, dispenser										



### Setting details

Anchor size	Ø8	Ø10	Ø12	Ø14	Ø16	Ø20	Ø25	Ø26	Ø28	Ø30	Ø32
Nominal diameter of drill bit $d_0$ [mm]	10 / 12 <sup>a)</sup>	12 / 14 <sup>a)</sup>	14 / 16 <sup>a)</sup>	18	20	25	32	32	35	37	40
Effective anchorage and drill hole depth range <sup>b)</sup>	$h_{ef,min}$ [mm]	60	60	70	75	80	90	100	104	112	120
	$h_{ef,max}$ [mm]	160	200	240	280	320	400	500	520	560	600
Minimum base material thickness $h_{min}$ [mm]	$h_{ef} + 30 \text{ mm} \geq 100 \text{ mm}$			$h_{ef} + 2 d_0$							
Minimum spacing $s_{min}$ [mm]	40	50	60	70	80	100	125	130	140	150	160
Minimum edge distance $c_{min}$ [mm]	40	45	45	50	50	65	70	75	75	80	80
Critical spacing for splitting failure $s_{cr,sp}$ [mm]	$2 c_{cr,sp}$										
Critical edge distance for splitting failure <sup>c)</sup> $c_{cr,sp}$ [mm]	$1,0 \cdot h_{ef}$		for $h / h_{ef} \geq 2,0$								
	$4,6 h_{ef} - 1,8 h$		for $2,0 > h / h_{ef} > 1,3$								
	$2,26 h_{ef}$		for $h / h_{ef} \leq 1,3$								
Critical spacing for concrete cone failure $s_{cr,N}$ [mm]	$2 c_{cr,N}$										
Critical edge distance for concrete cone failure <sup>d)</sup> $c_{cr,N}$ [mm]	$1,5 h_{ef}$										

For spacing (edge distance) smaller than critical spacing (critical edge distance) the design loads have to be reduced,

- a) Both given values for drill bit diameter can be used
- b)  $h_{ef,min} \leq h_{ef} \leq h_{ef,max}$  ( $h_{ef}$ : embedment depth)
- c)  $h$ : base material thickness ( $h \geq h_{min}$ )
- d) The critical edge distance for concrete cone failure depends on the embedment depth  $h_{ef}$  and the design bond resistance. The simplified formula given in this table is on the safe side.

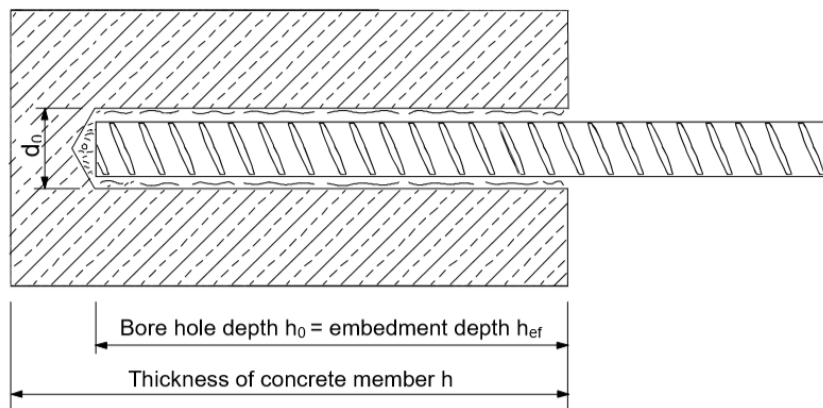
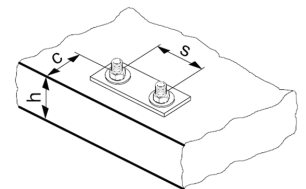



### Drilling and cleaning diameters

Rebar	Hammer drill (HD)	Hollow Drill Bit (HDB)	Diamond coring with Roughening Tool (RT) <sup>b)</sup>	Brush HIT-RB
d <sub>0</sub> [mm]				size [mm]
φ8	12 / 10 <sup>a)</sup>	12	-	12 / 10 <sup>a)</sup>
φ10	14 / 12 <sup>a)</sup>	14 / 12 <sup>a)</sup>	-	14 / 12 <sup>a)</sup>
φ12	16 / 14 <sup>a)</sup>	16 / 14 <sup>a)</sup>	-	16 / 14 <sup>a)</sup>
φ14	18	18	18	18
φ16	20	20	20	20
φ20	25	25	25	25
φ25	32	32	32	32
φ26	32	32	32	32
φ28	35	35	35	35
φ30	37	-	-	37
φ32	40	-	-	40

- a) Both given values can be used  
b) No cleaning required

### Associated components for the use of Hilti Roughening tool TE-YRT

Diamond coring		Roughening tool TE-YRT	Wear gauge RTG...
d <sub>0</sub> [mm]		d <sub>0</sub> [mm]	size
Nominal	measured		
18	17,9 to 18,2	18	18
20	19,9 to 20,2	20	20
22	21,9 to 22,2	22	22
25	24,9 to 25,2	25	25
28	27,9 to 28,2	28	28
30	29,9 to 30,2	30	30
32	31,9 to 32,2	32	32
35	34,9 to 35,2	35	35

### Installation parameters for use of the Hilti Roughening tool TE-YRT

h <sub>ef</sub> [mm]	Minimum roughening time t <sub>roughen</sub> [sec] (t <sub>roughen</sub> [sec] = h <sub>ef</sub> [mm] / 10)	Minimum blowing time t <sub>blowing</sub> [sec] (t <sub>blowing</sub> [sec] = t <sub>roughen</sub> [sec] + 20)
0 to 100	10	30
101 to 200	20	40
201 to 300	30	50
301 to 400	40	60
401 to 500	50	70
501 to 600	60	80

## Setting instructions

\*For detailed information on installation see instruction for use given with the package of the product,



### Safety regulations.

Review the Material Safety Data Sheet (MSDS) before use for proper and safe handling! Wear well-fitting protective goggles and protective gloves when working with Hilti HIT-HY 200-R V3.

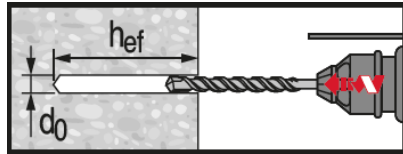

**Hammer drilled hole (HD)**

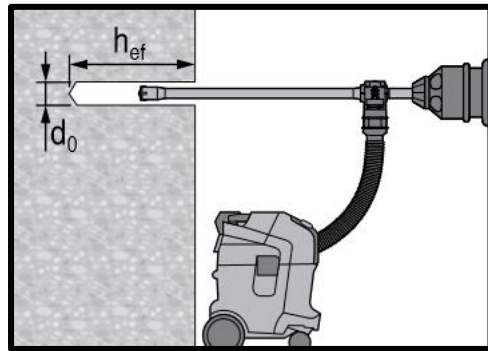

**Hammer drilled hole with Hollow Drilled Bit (HDB)**

No cleaning required

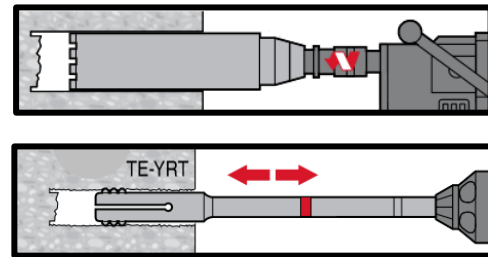

**Diamond Drilling + Roughening Tool (DD+RT)**

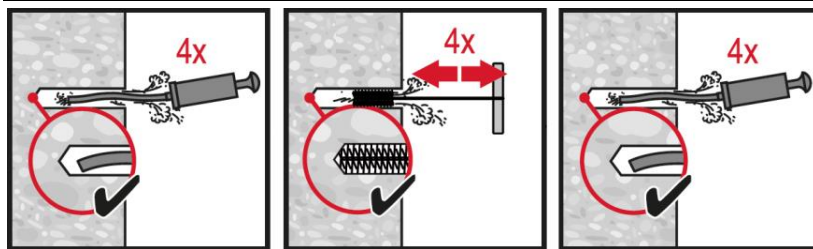

**Hammer drilling:**

**Manual cleaning (MC)**

for drill diameters  $d_0 \leq 20$  mm and drill hole depth  $h_0 \leq 10 \cdot d$ .

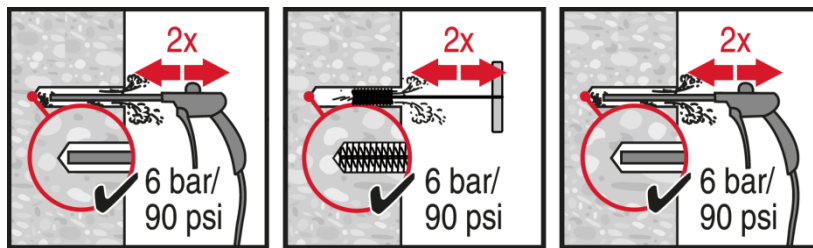

**Hammer drilling:**

**Compressed air cleaning (CAC)**

for all drill hole diameters  $d_0$  and drill hole depths  $h_0 \leq 20 \cdot d$ .

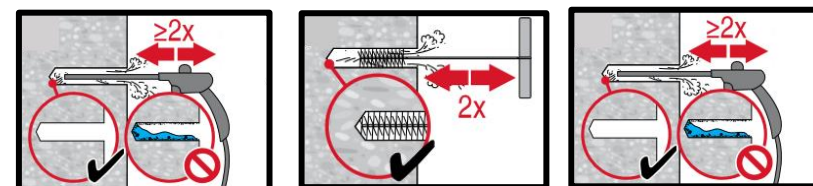

**Diamond cored holes with Hilti roughening tool:**

**Compressed air cleaning (CAC)**

for all drill hole diameters  $d_0$  and drill hole depths  $h_0$ .

Concrete  
Chemical anchors  
Mechanical anchors  
Plastic/Light duty metal anchors  
Insulation anchors

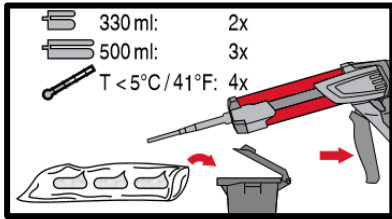
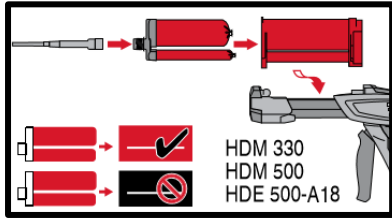

Injection system preparation.

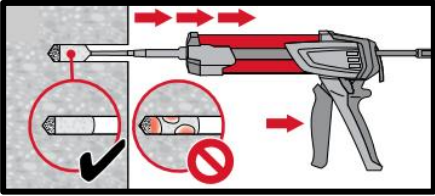
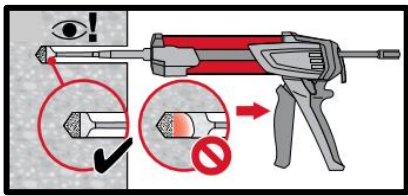

Injection method for drill hole depth  $h_{ef} \leq 250$  mm.

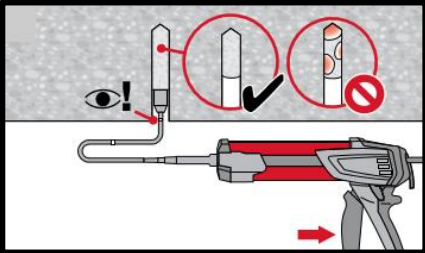
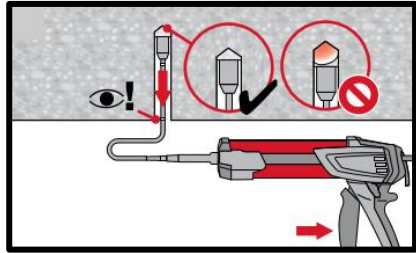

Injection method for overhead application and/or installations with embedment depth  $h_{ef} \geq 250$  mm.

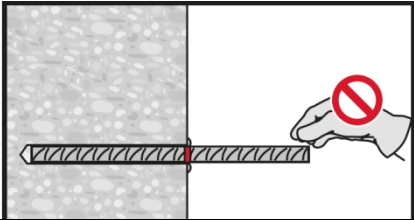
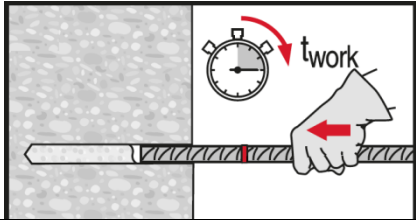

Setting element, observe working time "t<sub>work</sub>".

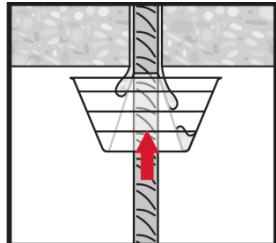
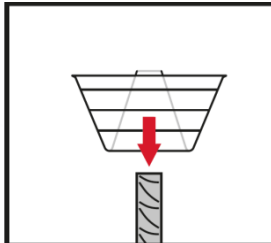
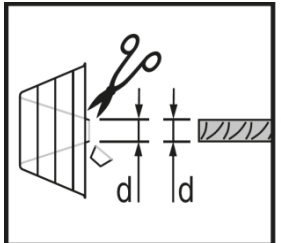

Setting element for overhead applications, observe working time "t<sub>work</sub>".

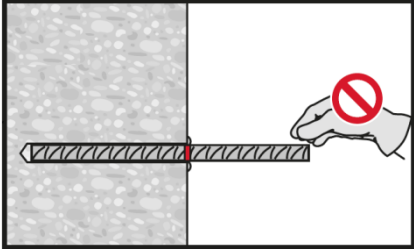
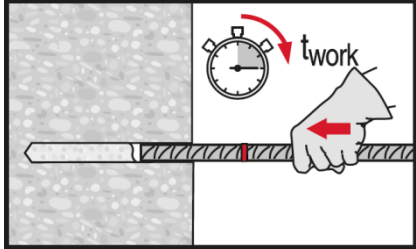

Setting element, observe working time "t<sub>work</sub>".

# HIT-HY 200-R V3 injection mortar

Rebar design (EOTA TR023) / Rebar elements / Concrete

## Injection mortar system



Hilti HIT-HY 200-R V3

330 ml foil pack  
(also available as 500 ml foil pack)



Rebar  
( $\phi 8$  -  $\phi 32$ )

## Benefits

- **SafeSet** technology: Simplified method of borehole preparation using either Hilti hollow drill bit for hammer drilling or Roughening tool for diamond cored applications
- HY 200-R version is formulated for best handling and cure time specifically for rebar applications
- Approved for ETA seismic C1 approval for post-installed-rebar
- Suitable for concrete C 12/15 to C 50/60
- Suitable for dry and water saturated concrete
- For rebar diameters up to 32 mm
- Non corrosive to rebar elements
- Good load capacity at elevated temperatures
- Suitable for embedment length up to 1000 mm
- Suitable for applications down to -10 °C

## Base material



Concrete (uncracked)



Concrete (cracked)

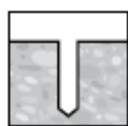

Dry concrete



Wet concrete

## Load conditions



Static/  
quasi-static



Seismic,  
ETA-C1



Fire resistance

## Installation conditions

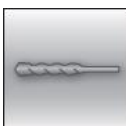

Hammer  
drilling



Diamond  
drilled holes<sup>c)</sup>

**SAFESET**

Hilti SafeSet  
technology

## Other informations



European  
Technical  
Assessment



CE  
conformity



PROFIS Rebar  
design  
Software

<sup>c)</sup>Diamond drilling only with Roughening Tool (RT)

## Approvals / certificates

Description	Authority / Laboratory	No. / date of issue
European technical Assessment <sup>a)</sup>	DIBt, Berlin	ETA-19/0600 / 2019-12-10 (HY200-R V3)

<sup>a)</sup> All data given in this section according to ETA-19/0600, issue 2019-12-10.

**Essential characteristics for rebar under tension load in concrete**

Rebar			φ8	φ10	φ12	φ14	φ16	φ20	φ25	φ26	φ28	φ30	φ32
<b>Diameter of rebar</b>	φ	[mm]	8	10	12	14	16	20	25	26	28	30	32
<b>Pull-out resistance</b>													
<b>Characteristic bond resistance in uncracked concrete C20/25</b>													
Temperature range I: 40°C/24°C	$T_{Rk,ucr}$	[N/mm <sup>2</sup> ]	12										
Temperature range II: 80°C/50°C	$T_{Rk,ucr}$	[N/mm <sup>2</sup> ]	10										
Temperature range II: 80°C/50°C	$T_{Rk,ucr}$	[N/mm <sup>2</sup> ]	8,5										
Influence of cracked concrete	$\Omega_{cr}$	[-]	0,53	0,58			0,61	0,64			0,73		
<b>Installation safety factor</b>													
Hammer drilling	$\gamma_{inst}$	[-]	1,0										
Hammer drilling with Hilti hollow drill bit TE-CD or TE-YD	$\gamma_{inst}$	[-]	1,0										
Diamond coring with roughening with Hilti roughening tool TE-YRT	$\gamma_{inst}$	[-]	-				1,0						
<b>Bond-splitting resistance</b>													
Product basic factor	$A_k$	[-]	4,1										
Exponent for influence of concrete compressive strength	sp1	[-]	0,31										
Exponent for influence of rebar diameter φ	sp2	[-]	0,32										
Exponent for influence of concrete cover $c_d$	sp3	[-]	0,67										
Exponent for influence of side concrete cover ( $c_{max}$ / $c_d$ )	sp4	[-]	0,25										
Exponent for influence of anchorage length $l_b$	lb1	[-]	0,45										
<b>Influence factors Ψ on bond resistance <math>T_{Rk}</math></b>													
Cracked and uncracked concrete: Factor for concrete strength	$\Psi_c$	C30/37	1,04										
		C40/45	1,07										
		C50/60	1,10										
Cracked and uncracked concrete: Sustained load factor	$\Psi_{sus}^0$	40°C/24°C	0,74										
		80°C/50°C	0,89										
		120°C/72°C	0,72										
<b>Concrete cone failure</b>													
Factor for uncracked concrete	$k_{ucr,N}$	[-]	11,0										
Factor for cracked concrete	$k_{cr,N}$	[-]	7,7										
Edge distance	$c_{cr,N}$	[mm]	$1,5 \cdot l_b$										
Spacing	$s_{cr,N}$	[mm]	$3,0 \cdot l_b$										

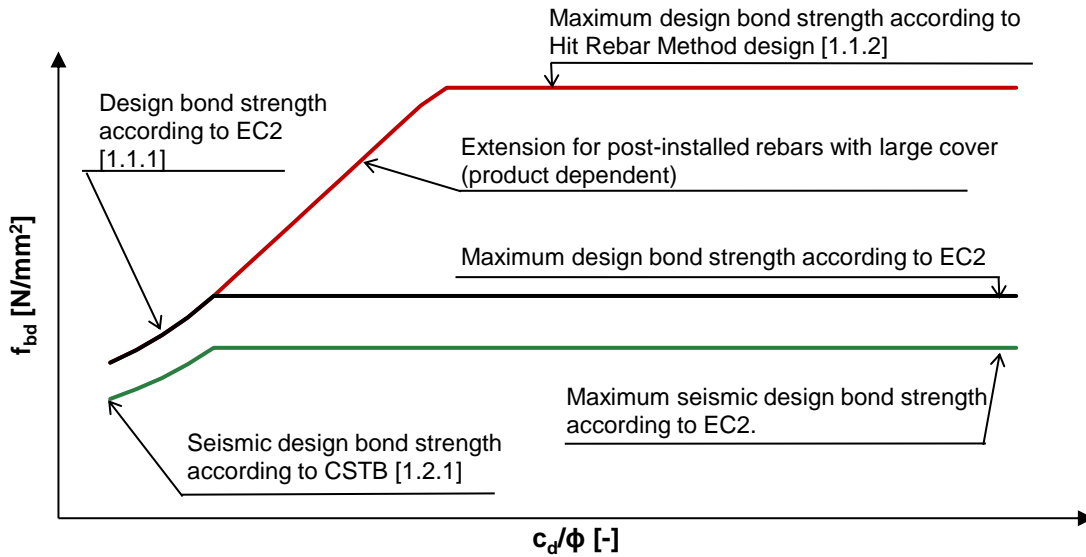

Effective limit on bond stress for post-installed rebar using Hilti mortar systems and design bond strength values as provided by the EC2.

**Static EC2 design (small concrete cover)**

**Design bond strength in N/mm<sup>2</sup> for good bond conditions**

All allowed drilling methods									
Rebar - size	Concrete class								
	C12/15	C16/20	C20/25	C25/30	C30/37	C35/45	C40/50	C45/55	C50/60
φ8 - φ32	1,6	2,0	2,3	2,7	3,0	3,4	3,7	4,0	4,3

For poor bond conditions multiply the values by 0,7. Values valid for uncracked and cracked concrete.

**Static Hit Rebar Method design (large concrete cover)**

**Maximum design bond strength in N/mm<sup>2</sup> for good bond conditions**

Non-cracked concrete, all allowed drilling methods								
Temperature range	Rebar - size	Concrete class						
		C20/25	C25/30	C30/37	C35/45	C40/45	C45/55	C50/60
I: 40°C/24°C	φ8 - φ32	8	8,2	8,3	8,4	8,6	8,7	8,8
II: 58°C/35°C		6,7	6,8	6,9	7,0	7,1	7,2	7,3
III: 70°C/43°C		5,7	5,8	5,9	6,0	6,1	6,1	6,2
Cracked concrete, all allowed drilling methods								
I: 40°C/24°C	φ12 - φ32	4,7	4,8	4,8	4,9	5,0	5,1	5,1
II: 58°C/35°C		3,7	3,7	3,8	3,9	3,9	4,0	4,0
III: 70°C/43°C		3,3	3,4	3,5	3,5	3,6	3,6	3,7

For poor bond conditions multiply the values by 0,7. \*The reduction factor for rebar diameter equal to 10 mm is 0,72

**Additional Hilti Technical Data:**

Reduction factor for splitting with large concrete cover:  $\delta = 0,306$  (Hilti additional data)

**Minimum anchorage length and minimum lap length**

The minimum anchorage length  $\ell_{b,min}$  and the minimum lap length  $\ell_{0,min}$  according to EN 1992-1-1 shall be multiplied by relevant **Amplification factor  $\alpha_{IB}$**  in the table below.



**Amplification factor  $\alpha_{lb}$  for the min. anchorage length and min. lap length for**
**All allowed hammer drilling methods**

Rebar - size	Concrete class								
	C12/15	C16/20	C20/25	C25/30	C30/37	C35/45	C40/50	C45/55	C50/60
$\phi 8 - \phi 32$	1,0								

**Anchorage length for characteristic steel strength  $f_{yk}=500 \text{ N/mm}^2$  for good conditions**
**All allowed drilling methods**

Rebar-size	Concrete class	Yielding load [kN]	$l_{b,min}^{1)}$ [mm]	$l_{0,min}^{1)}$ [mm]	$l_{bd,y}^{2)}$ ( $\alpha 2=1$ ) [mm]	$l_{bd,y}^{3)}$ ( $\alpha 2=0.7$ ) [mm]	$l_{bd,y,HRM}^{4)}$ ( $\alpha 2<0.7$ ) [mm]	$l_{max}^{-10^{\circ}C \leq Ct^{5)} \leq 0^{\circ}C}$ [mm]	$l_{max}^{Ct^{5)} > 0^{\circ}C}$ [mm]
$\phi 8$	C20/25	21,9	113	200	378	265	109	700	1000
$\phi 8$	C50/60	21,9	100	200	202	142	99	700	1000
$\phi 10$	C20/25	34,1	142	200	473	331	136	700	1000
$\phi 10$	C50/60	34,1	100	200	253	177	124	700	1000
$\phi 12$	C20/25	49,2	170	200	567	397	163	700	1000
$\phi 12$	C50/60	49,2	120	200	303	212	148	700	1000
$\phi 14$	C20/25	66,9	198	210	662	463	190	700	1000
$\phi 14$	C50/60	66,9	140	210	354	248	173	700	1000
$\phi 16$	C20/25	87,4	227	240	756	529	217	700	1000
$\phi 16$	C50/60	87,4	160	240	404	283	198	700	1000
$\phi 18$	C20/25	110,6	255	270	851	595	245	700	1000
$\phi 18$	C50/60	110,6	180	270	455	319	222	700	1000
$\phi 20$	C20/25	136,6	284	300	945	662	272	700	1000
$\phi 20$	C50/60	136,6	200	300	506	354	247	700	1000
$\phi 22$	C20/25	165,3	312	330	1040	728	299	700	1000
$\phi 22$	C50/60	165,3	220	330	556	389	272	700	1000
$\phi 24$	C20/25	196,7	340	360	1134	794	326	700	1000
$\phi 24$	C50/60	196,7	240	360	607	425	296	700	1000
$\phi 25$	C20/25	213,4	354	375	1181	827	340	700	1000
$\phi 25$	C50/60	213,4	250	375	632	442	309	700	1000
$\phi 26$	C20/25	230,8	369	390	1229	860	353	700	1000
$\phi 26$	C50/60	230,8	260	390	657	460	321	700	1000
$\phi 28$	C20/25	267,7	397	420	1323	926	380	700	1000
$\phi 28$	C50/60	267,7	280	420	708	495	346	700	1000
$\phi 30$	C20/25	307,3	425	450	1418	992	408	700	1000
$\phi 30$	C50/60	307,3	300	450	758	531	371	700	1000
$\phi 32$	C20/25	349,7	454	480	1512	1059	435	700	1000
$\phi 32$	C50/60	349,7	320	480	809	566	395	700	1000

- 1) According to EC2: EN 1992-1-1:2004  $l_{b,min}$  (8.6) and  $l_{0,min}$  (8.11) are calculated for good bond conditions with characteristic yield strength  $f_{yk} = 500 \text{ N/mm}^2$ ,  $\gamma_M=1,15$  and  $\alpha_6 = 1,0$
- 2) Embedment depth for yield of the rebar and for  $c_d/\phi = 1$  (characteristic yield strength  $f_{yk} = 500 \text{ N/mm}^2$ )
- 3) Embedment depth for yield of the rebar and for  $c_d/\phi = 3$  (characteristic yield strength  $f_{yk} = 500 \text{ N/mm}^2$ )
- 4) Embedment depth according to Hit Rebar design for yield of the rebar and for  $c_d/\phi > 8$  (Temperature range 1,
- 5) characteristic yield strength  $f_{yk} = 500 \text{ N/mm}^2$ )
- 6)  $c_t$ =concrete temperature

**Seismic data**
**Seismic reduction factor  $k_{b,seis}$  for hammer drilling (HD) and (HDB) and compressed air drilling (CA)**

Rebar - size	Reduction factor $k_{b,seis}$								
	Concrete class								
	C16/20	C20/25	C25/30	C30/37	C35/45	C40/50	C45/55	C50/60	
$\phi 10 - \phi 18$	1,0				0,90	0,82	0,76	0,71	
$\phi 20 - \phi 30$	1,0						0,92	0,86	
$\phi 32$	1,0								

For poor bond conditions multiply the values 0,7.



**Design values for the ultimate bond resistance  $f_{bd,seis}$  <sup>1)</sup> in N/mm<sup>2</sup> for seismic loading for hammer drilling (HD) and (HDB) and compressed air drilling (CA)**

Rebar - size	Bond resistance $f_{bd,seis}$							
	Concrete class							
	C16/20	C20/25	C25/30	C30/37	C35/45	C40/50	C45/55	C50/60
$\phi 10 - \phi 18$	2,0	2,3	2,7	3,0				
$\phi 20 - \phi 30$	2,0	2,3	2,7	3,0	3,4	3,7		
$\phi 32$	2,0	2,3	2,7	3,0	3,4	3,7	4,0	4,3

<sup>1)</sup> According to EN 1992-1-1:2004 for good bond conditions. For all other bond conditions multiply the values by 0.7.

**Materials**

**Material quality**

Part	Material
Rebar EN 1992-1-1	Bars and de-coiled rods class B or C with $f_{yk}$ and $k$ according to NDP or NCL of EN 1992-1-1 $f_{uk} = f_{tk} = k \cdot f_{yk}$

**Fitness for use**

Some creep tests have been conducted in accordance with ETAG guideline 001 part 5 and TR 023 in the following conditions: **in dry environment at 50 °C during 90 days.**

These tests show an excellent behaviour of the post-installed connection made with HIT-HY 200: low displacements with long term stability, failure load after exposure above reference load.

**Resistance to chemical substances**

Chemical	Resistance	Chemical	Resistance
Air	+	Gasoline	+
Acetic acid 10%	+	Glycole	o
Acetone	o	Hydrogen peroxide 10%	o
Ammonia 5%	+	Lactic acid 10%	+
Benzyl alcohol	-	Machinery oil	+
Chloric acid 10%	o	Methylethylketon	o
Chlorinated lime 10%	+	Nitric acid 10%	o
Citric acid 10%	+	Phosphoric acid 10%	+
Concrete plasticizer	+	Potassium Hydroxide pH 13,2	+
De-icing salt (Calcium chloride)	+	Sea water	+
Demineralized water	+	Sewage sludge	+
Diesel fuel	+	Sodium carbonate 10%	+
Drilling dust suspension pH 13,2	+	Sodium hypochlorite 2%	+
Ethanol 96%	-	Sulfuric acid 10%	+
Ethylacetate	-	Sulfuric acid 30%	+
Formic acid 10%	+	Toluene	o
Formwork oil	+	Xylene	o

- + resistant
- o resistant in short term (max. 48h) contact
- not resistant

**Electrical Conductivity**

HIT-HY 200 in the hardened state **is not conductive electrically**. Its electric resistivity is  $15,5 \cdot 10^9 \Omega \cdot \text{cm}$  (DIN IEC 93 – 12.93). It is adapted well to realize electrically insulating anchoring (ex: railway applications, subway)

## Setting information

### Installation temperature range

-10°C to +40°C

### Service temperature range

Hilti HIT-HY 200 injection mortar may be applied in the temperature ranges given below. An elevated base material temperature may lead to a reduction of the design bond resistance.

Temperature range	Base material temperature	Maximum long term base material temperature	Maximum short term base material temperature
Temperature range I	-40 °C to +80 °C	+50 °C	+80 °C

### Max short term base material temperature

Short-term elevated base material temperatures are those that occur over brief intervals, e.g. as a result of diurnal cycling.

### Max long term base material temperature

Long-term elevated base material temperatures are roughly constant over significant periods of time.

### Curing and working time

Temperature of the base material	HIT-HY 200-R V3	
	Maximum working time $t_{work}$	Minimum curing time $t_{cure}$
- 10°C < $T_{BM} \leq - 5^\circ\text{C}$	3 h	20 h
- 4°C < $T_{BM} \leq 0^\circ\text{C}$	1,5 h	8 h
1°C < $T_{BM} \leq 5^\circ\text{C}$	45 min	4 h
6°C < $T_{BM} \leq 10^\circ\text{C}$	30 min	2,5 h
11°C < $T_{BM} \leq 20^\circ\text{C}$	15 min	1,5 h
21°C < $T_{BM} \leq 30^\circ\text{C}$	9 min	1 h
31°C < $T_{BM} \leq 40^\circ\text{C}$	6 min	1 h

## Setting information

### Installation equipment

Rebar – size	$\phi 8 - \phi 16$	$\phi 18 - \phi 32$
Rotary hammer	TE 2 (-A)– TE 40(-A)	TE40 – TE80
Other tools	Blow out pump ( $h_{ef} \leq 10 \cdot d$ )	-
	Compressed air gun <sup>a)</sup> Set of cleaning brushes <sup>b)</sup> , dispenser, piston plug	

a) Compressed air gun with extension hose for all drill holes deeper than 250 mm (for  $\phi 8$  to  $\phi 12$ ) or deeper than  $20 \cdot \phi$  (for  $\phi > 12$  mm)

b) Automatic brushing with round brush for all drill holes deeper than 250 mm (for  $\phi 8$  to  $\phi 12$ ) or deeper than  $20 \cdot \phi$  (for  $\phi > 12$  mm)

### Minimum concrete cover $c_{min}$ of the post-installed rebar

Drilling method	Bar diameter [mm]	Minimum concrete cover $c_{min}$ [mm]	
		Without drilling aid	With drilling aid
Hammer drilling (HD) and (HDB)	$\phi < 25$	$30 + 0,06 \cdot l_v \geq 2 \cdot \phi$	$30 + 0,02 \cdot l_v \geq 2 \cdot \phi$
	$\phi \geq 25$	$40 + 0,06 \cdot l_v \geq 2 \cdot \phi$	$40 + 0,02 \cdot l_v \geq 2 \cdot \phi$
Compressed air drilling (CA)	$\phi < 25$	$50 + 0,08 \cdot l_v$	$50 + 0,02 \cdot l_v$
	$\phi \geq 25$	$60 + 0,08 \cdot l_v \geq 2 \cdot \phi$	$60 + 0,02 \cdot l_v \geq 2 \cdot \phi$
Diamond coring with roughening with Hilti Roughening tool TE-YRT (RT)	$\phi < 25$	$30 + 0,06 \cdot l_v \geq 2 \cdot \phi$	$30 + 0,02 \cdot l_v \geq 2 \cdot \phi$
	$\phi \geq 25$	$40 + 0,06 \cdot l_v \geq 2 \cdot \phi$	$40 + 0,02 \cdot l_v \geq 2 \cdot \phi$

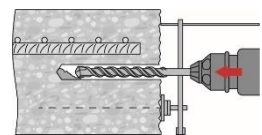

### Drilling and cleaning diameters

Rebar [mm]	Hammer drill (HD)	Hollow Drill Bit (HDB) <sup>b)</sup>	Compressed air drill (CA)	Diamond coring with roughening tool (RT) <sup>b)</sup>	Brush HIT-RB	Air nozzle HIT-RB
	d <sub>0</sub> [mm]				size [mm]	
φ8	12 / 10 <sup>a)</sup>	12	-	-	12 / 10 <sup>a)</sup>	12 / 10 <sup>a)</sup>
φ10	14 / 12 <sup>a)</sup>	14 / 12 <sup>a)</sup>	-	-	14 / 12 <sup>a)</sup>	14 / 12 <sup>a)</sup>
φ12	16 / 14 <sup>a)</sup>	16 / 14 <sup>a)</sup>	-	-	16 / 14 <sup>a)</sup>	16 / 14 <sup>a)</sup>
	-	-	17	-	18	16
φ14	18	18	17	18	18	18
φ16	20	20	-	-	20	20
	-	-	20	20	22	20
φ18	22	22	22	22	22	22
φ20	25	25	-	-	25	25
	-	-	26	25	28	25
φ22	28	28	28	28	28	28
φ24	32	32	32	32	32	32
φ25	32	32	32	32	32	
φ26	35	-	35	35	35	
φ28	35	-	35	35	35	
φ30	-	-	35	-	35	
	37	-	-	-	37	
φ32	40	-	40	-	40	

a) Maximum installation length l=250 mm.

b) No cleaning required

### Associated components for the use of Hilti Roughening tool TE-YRT

Diamond coring		Roughening tool TE-YRT	Wear gauge RTG...
d <sub>0</sub> [mm]		d <sub>0</sub> [mm]	size
Nominal	measured		
18	17,9 to 18,2	18	18
20	19,9 to 20,2	20	20
22	21,9 to 22,2	22	22
25	24,9 to 25,2	25	25
28	27,9 to 28,2	28	28
30	29,9 to 30,2	30	30
32	31,9 to 32,2	32	32
35	34,9 to 35,2	35	35

### Installation parameters for use of the Hilti Roughening tool TE-YRT

h <sub>ef</sub> [mm]	Minimum roughening time t <sub>roughen</sub> [sec] (t <sub>roughen</sub> [sec] = h <sub>ef</sub> [mm] / 10)	Minimum blowing time t <sub>blowing</sub> [sec] (t <sub>blowing</sub> [sec] = t <sub>roughen</sub> [sec] + 20)
0 to 100	10	30
101 to 200	20	40
201 to 300	30	50
301 to 400	40	60
401 to 500	50	70
501 to 600	60	80

Dispensers and corresponding maximum embedment depth  $l_{v,max}$

Rebar	Dispenser	
	HDM 330, HDM 500	HDE 500
	Concrete temp. $\geq -10^{\circ}\text{C}$	Concrete temp. $\geq 0^{\circ}\text{C}$
	$l_{v,max}$ [mm]	$l_{v,max}$ [mm]
$\phi 8 - \phi 32$	700	1000

Setting instructions

\*For detailed information on installation see instruction for use given with the package of the product.



Safety regulations.

Review the Material Safety Data Sheet (MSDS) before use for proper and safe handling! Wear well-fitting protective goggles and protective gloves when working with Hilti HIT-HY 200-R V3.

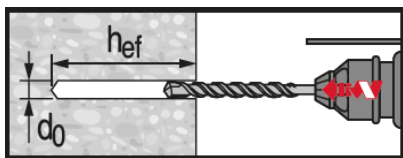

Hammer drilled hole (HD)

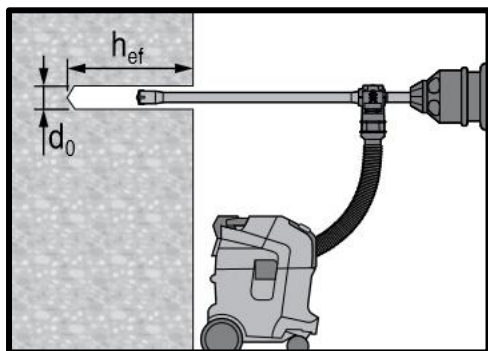

Hammer drilled hole with Hollow Drilled Bit (HDB)

No cleaning required

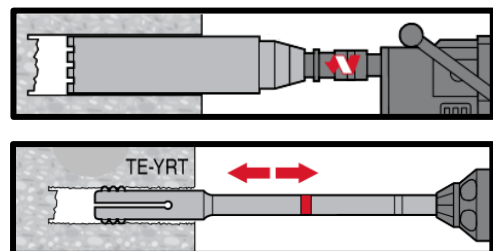

Diamond Drilling + Roughening Tool (DD+RT)

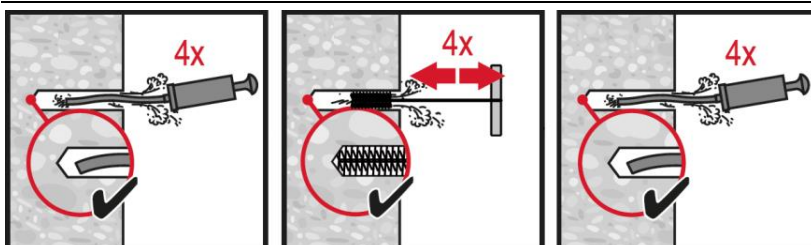

Hammer drilling:

Manual cleaning (MC)

for drill diameters  $d_0 \leq 20$  mm and drill hole depth  $h_0 \leq 10 \cdot d$ .

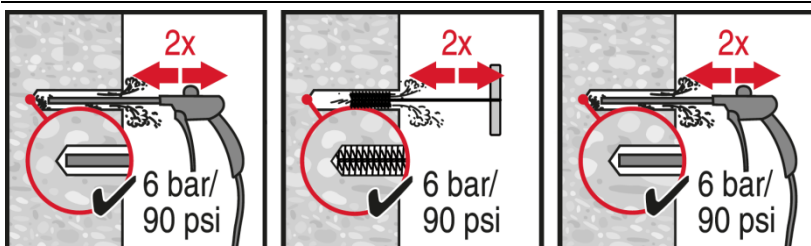

Hammer drilling:

Compressed air cleaning (CAC)

for all drill hole diameters  $d_0$  and drill hole depths  $h_0 \leq 20 \cdot d$ .

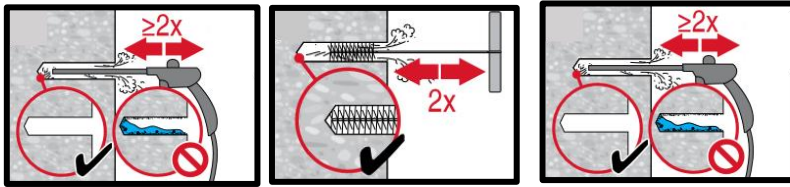

**Diamond cored holes with Hilti roughening tool:**

**Compressed air cleaning (CAC)**  
for all drill hole diameters  $d_0$  and drill hole depths  $h_0$ .

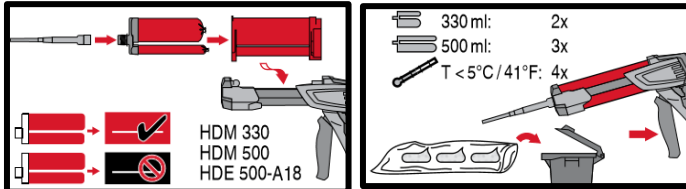

**Injection system preparation.**

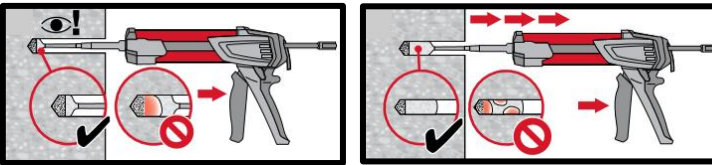

**Injection method for drill hole depth**  
 $h_{ef} \leq 250$  mm.

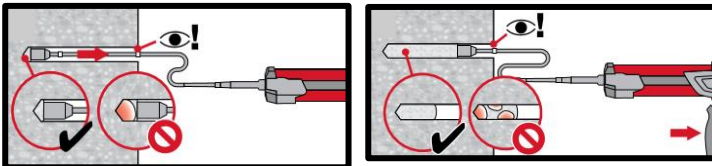

**Injection method for drill hole depth**  
 $h_{ef} > 250$  mm.

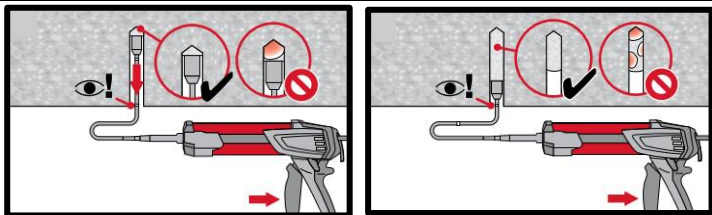

**Injection method for overhead application.**

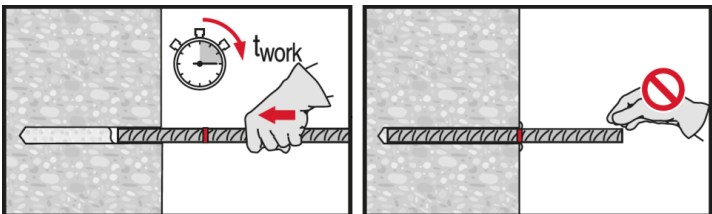

**Setting element, observe working time**  
“ $t_{work}$ ”.

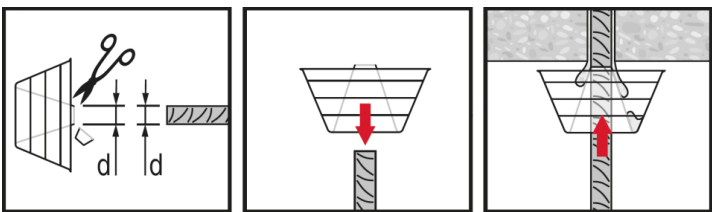

**Setting element for overhead applications, observe working time**  
“ $t_{work}$ ”.

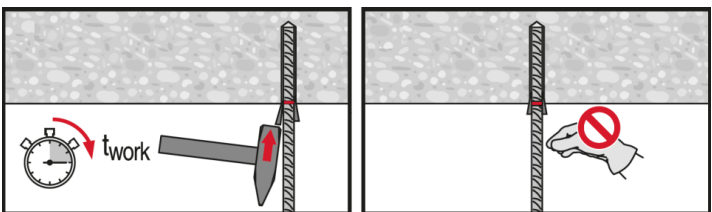

**Apply full load only after curing time**  
“ $t_{cure}$ ”.

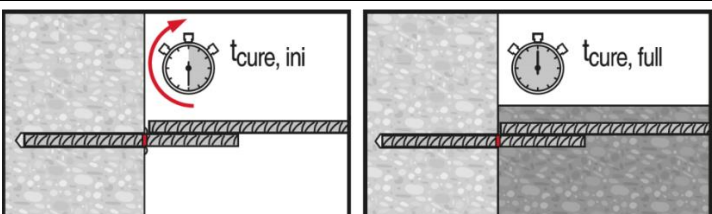



Concrete

Chemical anchors

Mechanical anchors

Plastic/Light duty metal anchors

Insulation anchors



# HIT-RE 100 injection mortar

Anchor design (ETAG 001) / Rods&Sleeves / Concrete

Concrete  
Chemical anchors

Mechanical anchors

Plastic/Light duty metal anchors

Insulation anchors

## Injection mortar system



Hilti HIT-RE 100  
500 ml foil pack  
(also available as  
330 ml foil pack)

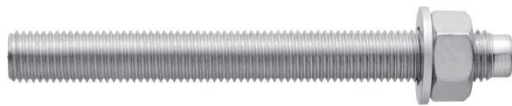

Anchor rods:  
HIT-V  
HIT-V-F  
HIT-V-R  
HIT-V-HCR  
(M8-M30)

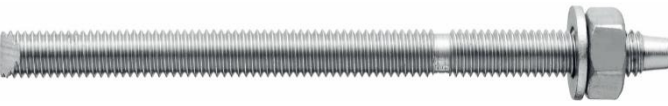

Anchor rods:  
HAS-(E)  
HAS-(E)-R  
HAS-(E)-HCR  
(M8-M30)

## Benefits

- Suitable for cracked and non-cracked concrete C 20/25 to C 50/60
- High loading capacity
- Suitable for dry and water saturated concrete
- Large diameter applications
- Long working time at elevated temperatures
- Odourless epoxy

## Base material



Concrete (non-cracked)

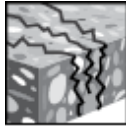

Concrete (cracked)

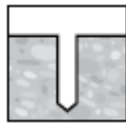

Dry concrete



Wet concrete

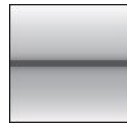

Static/  
quasi-static

## Load conditions

## Installation conditions



Hammer  
drilling

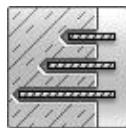

Variable  
embedment  
depth

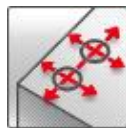

Small edge  
distance and  
spacing

**SAFE-ET**

Hilti **SafeSet**  
technology



European  
Technical  
Assessment



CE  
conformity

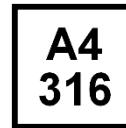

Corrosion  
resistance



High  
corrosion  
resistance

## Other informations

## Approvals / certificates

Description	Authority / Laboratory	No. / date of issue
European technical assessment <sup>a)</sup>	DIBt, Berlin	ETA-15/0882 / 2017-12-11

a) All data given in this section according to ETA-15/0882 issue 2017-12-11.



## Static and quasi-static loading (for a single anchor)

### All data in this section applies to

- Correct setting (See setting instruction)
- No edge distance and spacing influence
- Steel failure
- Anchor HIT-V and HAS-(E) with strength 5.8
- Base material thickness, as specified in the table
- One typical embedment depth, as specified in the table
- Concrete C 20/25,  $f_{ck,cube} = 25 \text{ N/mm}^2$
- Temperate range I  
(min. base material temperature  $-40^\circ\text{C}$ , max. long term/short term base material temperature:  $+24^\circ\text{C}/40^\circ\text{C}$ )

### Embedment depth and base material thickness

Anchor size		M8	M10	M12	M16	M20	M24	M27	M30
Typical embedment depth	[mm]	80	90	110	125	170	210	240	270
Base material thickness	[mm]	110	120	140	165	220	270	300	340

### Characteristic resistance

Anchor size		M8	M10	M12	M16	M20	M24	M27	M30
<b>Non-cracked concrete</b>									
Tension $N_{Rk}$	HIT-V, HAS-(E) [kN]	18,3	29,0	42,2	70,6	111,9	153,7	187,8	224,0
Shear $V_{Rk}$	HIT-V, HAS-(E) [kN]	9,2	14,5	21,1	39,3	61,3	88,3	114,8	140,3
<b>Cracked concrete</b>									
Tension $N_{Rk}$	HIT-V, HAS-(E) [kN]	-	19,8	29,0	40,8	64,1	95,0	112,0	140,0
Shear $V_{Rk}$	HIT-V, HAS-(E) [kN]	-	14,5	21,1	39,3	61,3	88,3	114,8	140,3

### Design resistance

Anchor size		M8	M10	M12	M16	M20	M24	M27	M30
<b>Non-cracked concrete</b>									
Tension $N_{Rd}$	HIT-V, HAS-(E) [kN]	12,2	19,3	27,7	33,6	53,3	73,2	89,4	106,7
Shear $V_{Rd}$	HIT-V, HAS-(E) [kN]	7,3	11,6	16,9	31,4	49,0	70,6	91,8	112,2
<b>Cracked concrete</b>									
Tension $N_{Rd}$	HIT-V, HAS-(E) [kN]	-	9,4	13,8	19,4	30,5	45,2	53,3	66,6
Shear $V_{Rd}$	HIT-V, HAS-(E) [kN]	-	11,6	16,9	31,4	49,0	70,6	91,8	112,2

### Recommended loads <sup>a)</sup>

Anchor size		M8	M10	M12	M16	M20	M24	M27	M30
<b>Non-cracked concrete</b>									
Tension $N_{Rec}$	HIT-V, HAS-(E) [kN]	8,7	13,8	19,8	24,0	38,1	52,3	63,9	76,2
Shear $V_{Rec}$	HIT-V, HAS-(E) [kN]	5,2	8,3	12,0	22,4	35,0	50,4	65,6	80,1
<b>Cracked concrete</b>									
Tension $N_{Rec}$	HIT-V, HAS-(E) [kN]	-	6,7	9,9	13,9	21,8	32,3	38,1	47,6
Shear $V_{Rec}$	HIT-V, HAS-(E) [kN]	-	8,3	12,0	22,4	35,0	50,4	65,6	80,1

a) With overall partial safety factor for action  $\gamma=1,4$ . The partial safety factors for action depend on the type of loading and shall be taken from national regulations.

## Materials

### Mechanical properties

Anchor size		M8	M10	M12	M16	M20	M24	M27	M30
Nominal tensile strength $f_{uk}$	HIT-V 5.8 HAS-(E) 5.8 [N/mm <sup>2</sup> ]	500	500	500	500	500	500	500	500
	HIT-V 8.8 HAS-(E) 8.8 [N/mm <sup>2</sup> ]	800	800	800	800	800	800	800	800
	HIT-V-R HAS-(E)R [N/mm <sup>2</sup> ]	700	700	700	700	700	700	500	500
	HIT-V-HCR HAS-(E)HCR [N/mm <sup>2</sup> ]	800	800	800	800	800	700	700	700
Yield strength $f_{yk}$	HIT-V 5.8 HAS-(E) 5.8 [N/mm <sup>2</sup> ]	400	400	400	400	400	400	400	400
	HIT-V 8.8 HAS-(E) 8.8 [N/mm <sup>2</sup> ]	640	640	640	640	640	640	640	640
	HIT-V-R HAS-(E)R [N/mm <sup>2</sup> ]	450	450	450	450	450	450	210	210
	HIT-V-HCR HAS-(E)HCR [N/mm <sup>2</sup> ]	640	640	640	640	640	400	400	400
Stressed cross-section $A_s$	HIT-V [mm <sup>2</sup> ]	36,6	58,0	84,3	157	245	353	459	561
	HAS-(E) [mm <sup>2</sup> ]	32,8	52,3	76,2	144,0	225,0	324,0	427,0	519,0
Moment of resistance $W$	HIT-V [mm <sup>3</sup> ]	31,2	62,3	109	277	541	935	1387	1874
	HAS-(E) [mm <sup>3</sup> ]	27,0	54,1	93,8	244,0	474,0	809,0	1274,0	1706,0

### Material quality for HIT-V

Part	Material
<b>Zinc coated steel</b>	
Threaded rod, HIT-V 5.8 (F) HAS-(E) 5.8	Strength class 5.8; Elongation at fracture A5 > 8% ductile Electroplated zinc coated $\geq 5\mu\text{m}$ ; (F) hot dip galvanized $\geq 45\mu\text{m}$
Threaded rod, HIT-V 8.8 (F) HAS-(E) 8.8	Strength class 8.8; Elongation at fracture A5 > 12% ductile Electroplated zinc coated $\geq 5\mu\text{m}$ ; (F) hot dip galvanized $\geq 45\mu\text{m}$
Washer	Electroplated zinc coated $\geq 5\mu\text{m}$ , hot dip galvanized $\geq 45\mu\text{m}$
Nut	Strength class of nut adapted to strength class of threaded rod. Electroplated zinc coated $\geq 5\mu\text{m}$ , hot dip galvanized $\geq 45\mu\text{m}$
<b>Stainless Steel</b>	
Threaded rod, HIT-V-R HAS-(E)-R	Strength class 70 for $\leq M24$ and strength class 50 for $> M24$ ; Elongation at fracture A5 > 8% ductile Stainless steel 1.4401; 1.4404; 1.4578; 1.4571; 1.4439; 1.4362
Washer	Stainless steel 1.4401, 1.4404, 1.4578, 1.4571, 1.4439, 1.4362 EN 10088-1:2014
Nut	Stainless steel 1.4401, 1.4404, 1.4578, 1.4571, 1.4439, 1.4362 EN 10088-1:2014
<b>High corrosion resistant steel</b>	
Threaded rod, HIT-V-HCR HAS-(E)-HCR	Strength class 80 for $\leq M20$ and class 70 for $> M20$ , Elongation at fracture A5 > 8% ductile High corrosion resistance steel 1.4529; 1.4565;
Washer	High corrosion resistant steel 1.4529, 1.4565 EN 10088-1:2014
Nut	High corrosion resistant steel 1.4529, 1.4565 EN 10088-1:2014

## Setting information

### Installation temperature range:

+5°C to +40°C

### Service temperature range

Hilti HIT-RE 100 injection mortar may be applied in the temperature ranges given below. An elevated base material temperature may lead to a reduction of the design bond resistance.

Temperature range	Base material temperature	Max. long term base material temperature	Max. short term base material temperature
Temperature range I	-40 °C to + 40 °C	+ 24 °C	+ 40 °C
Temperature range II	-40 °C to + 58 °C	+ 35 °C	+ 58 °C
Temperature range III	-40 °C to + 70 °C	+ 43 °C	+ 70 °C

### Max. short term base material temperature

Short term elevated base material temperatures are those that occur over brief intervals, e.g. as a result of diurnal cycling.

### Max. long term base material temperature

Long term elevated base material temperatures are roughly constant over significant periods of time.

### Working time and curing time

Temperature of the base material	Max. working time in which rebar can be inserted and adjusted $t_{work}$	Min. curing time before rebar can be fully loaded $t_{cure}$
$5\text{ °C} \leq T_{BM} < 10\text{ °C}$	2 h	72 h
$10\text{ °C} \leq T_{BM} < 15\text{ °C}$	1,5 h	48 h
$15\text{ °C} \leq T_{BM} < 20\text{ °C}$	30 min	24 h
$20\text{ °C} \leq T_{BM} < 30\text{ °C}$	20 min	12 h
$30\text{ °C} \leq T_{BM} < 40\text{ °C}$	12 min	8 h
40 °C	12 min	4 h

The curing time data are valid for dry base material only. In wet base material the curing times must be doubled.

### Setting details

Anchor size	M8	M10	M12	M16	M20	M24	M27	M30
Nominal diameter of drill bit $d_0$ [mm]	10	12	14	18	22	28	30	35
Diameter of element $d$ [mm]	8	10	12	16	20	24	27	30
Effective anchorage and drill hole depth $h_{ef}$ [mm]	60 to 160	60 to 200	70 to 240	80 to 320	90 to 400	96 to 480	108 to 540	120 to 600
Minimum base material thickness $h_{min}$ [mm]	$h_{ef} + 30 \geq 100$ mm			$h_{ef} + 2 d_0$				
Diameter of clearance hole in the fixture $d_f$ [mm]	9	12	14	18	22	26	30	33
Minimum spacing $s_{min}$ [mm]	40	50	60	80	100	120	135	150
Minimum edge distance $c_{min}$ [mm]	40	50	60	80	100	120	135	150
Critical spacing for splitting failure $s_{cr,sp}$ [mm]	$2 C_{cr,sp}$							
Critical edge distance for splitting failure <sup>a)</sup> $c_{cr,sp}$ [mm]	$1,0 \cdot h_{ef}$ for $h / h_{ef} \geq 2,0$							
	$4,6 h_{ef} - 1,8 h$ for $2,0 > h / h_{ef} > 1,3$							
	$2,26 h_{ef}$ for $h / h_{ef} \leq 1,3$							
Critical spacing for concrete cone failure $s_{cr,N}$ [mm]	$2 C_{cr,N}$							
Critical edge distance for concrete cone failure <sup>b)</sup> $c_{cr,N}$ [mm]	$1,5 h_{ef}$							
Torque moment <sup>c)</sup> $T_{max}$ [Nm]	10	20	40	80	150	200	270	300

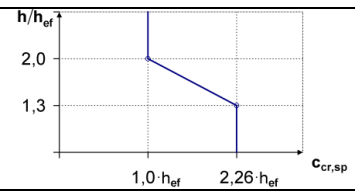

For spacing (edge distance) smaller than critical spacing (critical edge distance) the design loads have to be reduced.

- a)  $h_{ef,min} \leq h_{ef} \leq h_{ef,max}$  ( $h_{ef}$ : embedment depth)  $h$ : base material thickness ( $h \geq h_{min}$ )
- b) The critical edge distance for concrete cone failure depends on the embedment depth  $h_{ef}$  and the design bond resistance. The simplified formula given in this table is on the safe side.
- c) This is the maximum recommended torque moment to avoid splitting failure during installation for anchors with minimum spacing and/or edge distance.

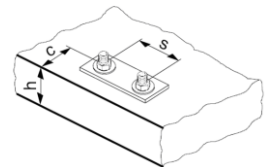

### Installation equipment

Anchor size	M8	M10	M12	M16	M20	M24	M27	M30
Rotary hammer	TE 2 – TE 16				TE 40 – TE 80			
Other tools	Compressed air gun or blow out pump Set of cleaning brushes, dispenser, piston plug							

### Drilling and cleaning parameters

HIT-V HAS	Drill bit diameters $d_0$ [mm]		Installation size [mm]	
	Hammer drill (HD)	Hollow Drill Bit (HDB)	Brush HIT-RB	Piston plug HIT-SZ
<b>M8</b>	10	-	10	-
<b>M10</b>	12	12	12	12
<b>M12</b>	14	14	14	14
<b>M16</b>	18	18	18	18
<b>M20</b>	22	22	22	22
<b>M24</b>	28	28	28	28
<b>M27</b>	30	-	30	30
<b>M30</b>	35	35	35	35

## Setting instructions

\*For detailed information on installation see instruction for use given with the package of the product.



### Safety regulations.

Review the Material Safety Data Sheet (MSDS) before use for proper and safe handling! Wear well-fitting protective goggles and protective gloves when working with Hilti HIT-RE 100.

### Drilling

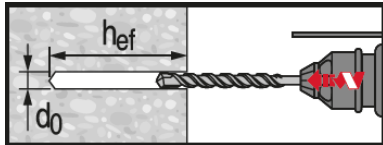

#### Hammer drilled hole

For dry and wet concrete.

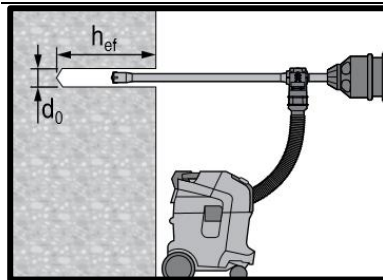

#### Hammer drilled hole with Hollow Drilled Bit (HDB)

No cleaning required.

### Cleaning

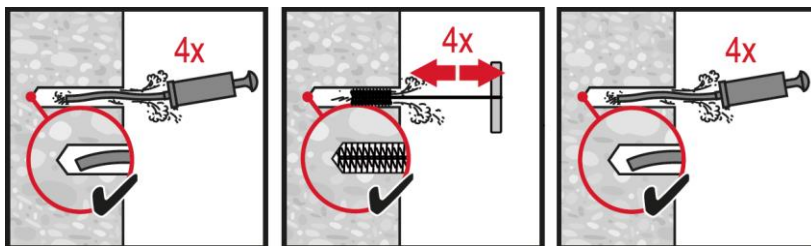

#### Manual cleaning (MC) Non-cracked concrete only

for drill diameters  $d_0 \leq 20$  mm and drill hole depth  $h_0 \leq 10 \cdot d$ .

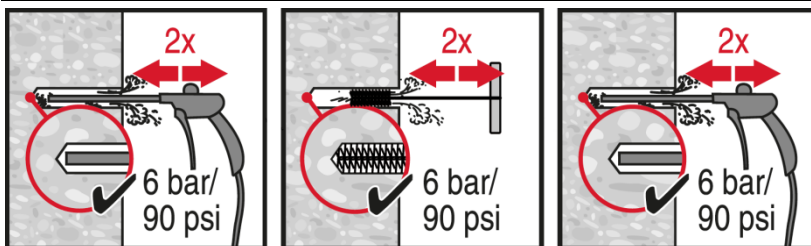

#### Compressed air cleaning (CAC)

for all drill hole diameters  $d_0$  and drill hole depths  $h_0 \leq 20 \cdot d$ .

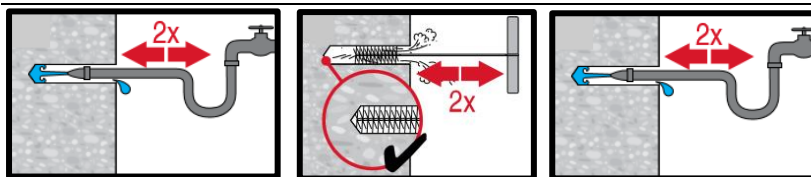

#### Compressed air cleaning (CAC) cleaning of flooded holes

for all drill hole diameters  $d_0$  and drill hole depths  $h_0$ .

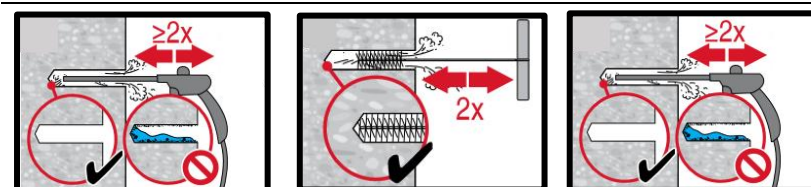

### Injection system

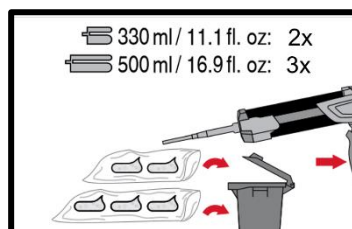
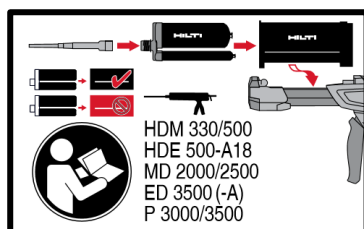

#### Injection system preparation.

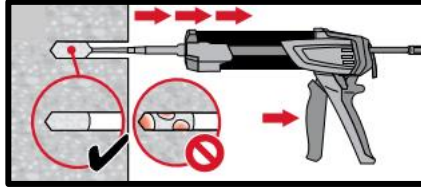
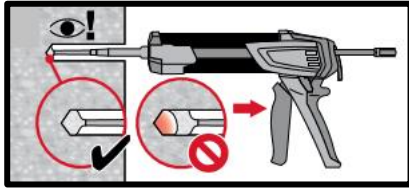

**Injection method** for drill hole depth  $h_{ef} \leq 250$  mm.

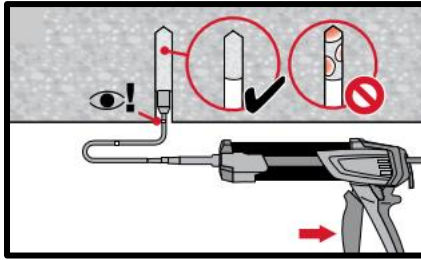
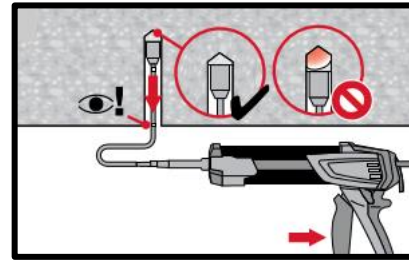

**Injection method** for overhead application and/or installation with embedment depth  $h_{ef} > 250$  mm.

## Setting the element

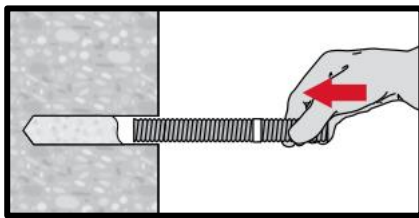

**Setting element**, observe working time " $t_{work}$ ",

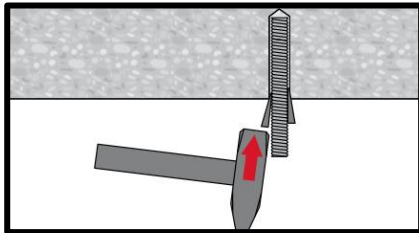

**Setting element** for overhead applications, observe working time " $t_{work}$ ",

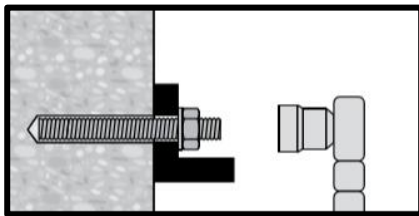

**Loading the anchor:** After required curing time  $t_{cure}$  the anchor can be loaded.



Concrete

Chemical anchors

Mechanical anchors

Plastic/Light duty metal anchors







Insulation anchors



# HIT-RE 100 injection mortar

Anchor design (ETAG 001) / Rebar elements / Concrete

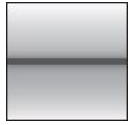
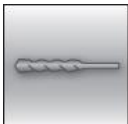
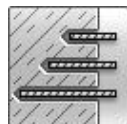
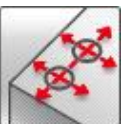
Injection mortar system	Benefits
   	<p>Hilti HIT-RE 100 330 ml foil pack  (also available as 500 ml and 1400 ml foil pack)</p> <p>Rebar B500B (<math>\phi 8</math>-<math>\phi 32</math>)</p> <ul style="list-style-type: none"> <li>- Suitable for cracked and non-cracked concrete C 20/25 to C 50/60</li> <li>- High loading capacity</li> <li>- Suitable for dry and water saturated concrete</li> <li>- Large diameter applications</li> <li>- Long working time at elevated temperatures</li> <li>- Odourless epoxy</li> </ul>

Base material	Load conditions			
 Concrete (non-cracked)	 Concrete (cracked)	 Dry concrete	 Wet concrete	 Static/ quasi-static
Installation conditions	Other informations			
 Hammer drilling	 Variable embedment depth	 Small edge distance and spacing	 European Technical Assessment	 CE conformity

### Approvals / certificates

Description	Authority / Laboratory	No. / date of issue
European technical assessment <sup>a)</sup>	CSTB, Marne la Vallée	ETA-15/0882 / 2017-12-11

b) All data given in this section according to ETA-15/0882 issue 2017-12-11.

## Static and quasi-static loading (for a single anchor)

### All data in this section applies to

- Correct setting (See setting instruction)
- No edge distance and spacing influence
- Steel failure
- Base material thickness, as specified in the table
- One typical embedment depth, as specified in the table
- One anchor material, as specified in the tables
- Concrete C 20/25,  $f_{ck,cube} = 25 \text{ N/mm}^2$
- Temperature range I  
(min. base material temperature  $-40^\circ\text{C}$ , max. long term/short term base material temperature:  $+24^\circ\text{C}/40^\circ\text{C}$ )

### Embedment depth and base material thickness for static and quasi-static loading data

Anchor- size	$\phi 8$	$\phi 10$	$\phi 12$	$\phi 14$	$\phi 16$	$\phi 20$	$\phi 25$	$\phi 26$	$\phi 28$	$\phi 30$	$\phi 32$
Typical embedment depth [mm]	80	90	110	125	125	170	210	230	270	285	300
Base material thickness [mm]	110	120	140	161	165	220	274	294	340	359	380

### Characteristic resistance

Anchor- size B500 B	$\phi 8$	$\phi 10$	$\phi 12$	$\phi 14$	$\phi 16$	$\phi 20$	$\phi 25$	$\phi 26$	$\phi 28$	$\phi 30$	$\phi 32$
<b>Non-cracked concrete</b>											
Tensile $N_{Rk}$	28,0	39,6	58,1	66,0	70,6	111,9	153,7	176,2	224,0	243,0	262,4
Shear $V_{Rk}$	14,0	22,0	31,0	42,0	55,0	86,0	135,0	146,0	169,0	194,0	221,0
<b>Cracked concrete</b>											
Tensile $N_{Rk}$	-	19,8	29,0	35,7	40,8	64,1	99,0	103,3	130,6	147,7	165,9
Shear $V_{Rk}$	-	22,0	31,0	42,0	55,0	86,0	135,0	146,0	169,0	194,0	221,0

### Design resistance

Anchor- size B500 B	$\phi 8$	$\phi 10$	$\phi 12$	$\phi 14$	$\phi 16$	$\phi 20$	$\phi 25$	$\phi 26$	$\phi 28$	$\phi 30$	$\phi 32$
<b>Non-cracked concrete</b>											
Tensile $N_{Rd}$	13,4	18,8	27,6	31,4	33,6	53,3	73,2	83,9	106,7	115,7	125,0
Shear $V_{Rd}$	11,2	14,7	20,7	28,0	36,7	57,3	90,0	97,3	129,3	129,3	147,3
<b>Cracked concrete</b>											
Tensile $N_{Rd}$	-	9,4	13,8	17,0	19,4	30,5	47,1	49,2	62,2	70,3	79,0
Shear $V_{Rd}$	-	14,7	20,7	28,0	36,7	57,3	90,0	97,3	129,3	129,3	147,3

### Recommended loads <sup>a)</sup>

Anchor- size B500 B	$\phi 8$	$\phi 10$	$\phi 12$	$\phi 14$	$\phi 16$	$\phi 20$	$\phi 25$	$\phi 26$	$\phi 28$	$\phi 30$	$\phi 32$
<b>Non-cracked concrete</b>											
Tensile $N_{Rd}$	9,6	13,5	19,7	22,4	24,0	38,1	52,3	59,9	76,2	82,6	89,3
Shear $V_{Rd}$	8,0	10,5	14,8	20,0	26,2	41,0	64,3	69,5	80,5	92,4	105,2
<b>Cracked concrete</b>											
Tensile $N_{Rd}$	-	6,7	9,9	12,2	13,9	21,8	33,7	35,1	44,4	50,2	56,4
Shear $V_{Rd}$	-	10,5	14,8	20,0	26,2	41,0	64,3	69,5	80,5	92,4	105,2

a) With overall partial safety factor for action  $\gamma=1,4$ , The partial safety factors for action depend on the type of loading and shall be taken from national regulations,

## Materials

### Mechanical properties

Anchor size	φ8	φ10	φ12	φ14	φ16	φ20	φ25	φ26	φ28	φ30	φ32
Nominal tensile strength $f_{uk}$ [N/mm <sup>2</sup> ]	550	550	550	550	550	550	550	550	550	550	550
Yield strength $f_{yk}$ [N/mm <sup>2</sup> ]	500	500	500	500	500	500	500	500	500	500	500
Stressed cross-section $A_s$ [mm <sup>2</sup> ]	50,3	78,5	113,1	153,9	201,1	314,2	490,9	531	615,8	707	804,2
Moment of resistance $W$ [mm <sup>3</sup> ]	50,3	98,2	169,6	269,4	402,1	785,4	1534	1726	2155	2651	3217

### Material quality

Part	Material
Rebar EN 1992-1-1:2004	Bars and de-coiled rods class B or C II according to NDP or NCL of EN 1992-1-1/NA:2013

## Setting information

### Installation temperature

+ 5°C to + 40°C

### Service temperature range

Hilti HIT-RE 100 injection mortar may be applied in the temperature ranges given below, An elevated base material temperature may lead to a reduction of the design bond resistance,

Temperature range	Base material temperature	Max, long term base material temperature	Max, short term base material temperature
Temperature range I	-40 °C to + 40 °C	+ 24 °C	+ 40 °C
Temperature range II	-40 °C to + 58 °C	+ 35 °C	+ 58 °C
Temperature range III	-40 °C to + 70 °C	+ 43 °C	+ 70 °C

### Max, short term base material temperature

Short term elevated base material temperatures are those that occur over brief intervals, e.g, as a result of diurnal cycling,

### Max, long term base material temperature

Long term elevated base material temperatures are roughly constant over significant periods of time,

### Working time and curing time

Temperature of the base material	Max, working time in which rebar can be inserted and adjusted $t_{work}$	Min, curing time before rebar can be fully loaded $t_{cure}$
5 °C ≤ $T_{BM}$ < 10 °C	2 h	72 h
10 °C ≤ $T_{BM}$ < 15 °C	1,5 h	48 h
15 °C ≤ $T_{BM}$ < 20 °C	30 min	24 h
20 °C ≤ $T_{BM}$ < 30 °C	20 min	12 h
30 °C ≤ $T_{BM}$ < 40 °C	12 min	8 h
40 °C	12 min	4 h

The curing time data are valid for dry base material only, In wet base material the curing times must be doubled,

### Setting details

Anchor size		Ø8	Ø10	Ø12		Ø14	Ø16	Ø20	Ø25	Ø26	Ø28	Ø30	Ø32
Nominal diameter of drill bit	$d_0$ [mm]	10 / 12 <sup>a)</sup>	12 / 14 <sup>a)</sup>	14 <sup>a)</sup>	16 <sup>a)</sup>	18	20	24 / 25 <sup>a)</sup>	30 / 32 <sup>a)</sup>	32	35	37	40
Effective anchorage and drill hole depth range <sup>b)</sup>	$h_{ef,mi}$ [mm]	60	60	70	70	75	80	90	100	104	112	120	128
	$h_{ef,ma}$ [mm]	160	200	240	240	280	320	400	500	520	560	600	640
Minimum base material thickness	$h_{min}$ [mm]	$h_{ef} + 30 \text{ mm}$ $\geq 100 \text{ mm}$				$h_{ef} + 2 d_0$							
Minimum spacing	$s_{min}$ [mm]	40	50	60	60	70	80	100	125	130	140	150	160
Minimum edge	$c_{min}$ [mm]	40	50	60	60	70	80	100	125	130	140	150	160
Critical spacing for splitting failure	$s_{cr,sp}$ [mm]	$2 C_{cr,sp}$											
Critical edge distance for splitting failure <sup>c)</sup>	$c_{cr,sp}$ [mm]	$1,0 \cdot h_{ef}$				for $h / h_{ef} \geq 2,0$							
		$4,6 h_{ef} - 1,8 h$				for $2,0 > h / h_{ef} > 1,3$							
		$2,26 h_{ef}$				for $h / h_{ef} \leq 1,3$							
Critical spacing for concrete cone failure	$s_{cr,N}$ [mm]	$2 C_{cr,N}$											
Critical edge distance for concrete cone failure <sup>d)</sup>	$c_{cr,N}$ [mm]	$1,5 h_{ef}$											

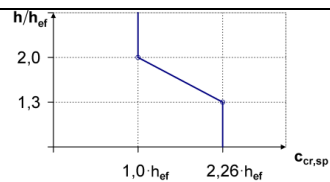

For spacing (edge distance) smaller than critical spacing (critical edge distance) the design loads have to be reduced,

a) Both given values for drill bit diameter can be used

b)  $h_{ef,min} \leq h_{ef} \leq h_{ef,max}$  ( $h_{ef}$ : embedment depth)

c)  $h$ : base material thickness ( $h \geq h_{min}$ )

d) The critical edge distance for concrete cone failure depends on the embedment depth  $h_{ef}$  and the design bond resistance, The simplified formula given in this table is on the save side,

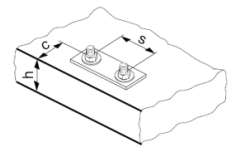

### Installation equipment

Anchor size	Ø8	Ø10	Ø12	Ø14	Ø16	Ø20	Ø25	Ø26	Ø28	Ø30	Ø32
Rotary hammer	TE 2 – TE 16					TE 40 – TE 80					
Other tools	Compressed air gun or blow out pump Set of cleaning brushes, dispenser, piston plug										

### Drilling and cleaning parameters

Rebar [mm]	Drill bit diameters $d_0$ [mm]		Installation size [mm]	
	Hammer drill (HD)	Hollow Drill Bit (HDB)	Brush HIT-RB	Piston plug HIT-SZ
Ø8	10 / 12 <sup>a)</sup>	12 <sup>a)</sup>	10 / 12 <sup>a)</sup>	- / 12 <sup>a)</sup>
Ø10	12 / 14 <sup>a)</sup>	12 / 14 <sup>a)</sup>	12 / 14 <sup>a)</sup>	12 / 14 <sup>a)</sup>
Ø12	14 / 16 <sup>a)</sup>	14 / 16 <sup>a)</sup>	14 / 16 <sup>a)</sup>	14 / 16 <sup>a)</sup>
Ø14	18	18	18	18
Ø16	20	20	20	20
Ø20	24 / 25 <sup>a)</sup>	24 / 25 <sup>a)</sup>	24 / 25 <sup>a)</sup>	24 / 25 <sup>a)</sup>
Ø25	30 / 32 <sup>a)</sup>	32 <sup>a)</sup>	30 / 32 <sup>a)</sup>	30 / 32 <sup>a)</sup>
Ø26	32	32	32	32
Ø28	35	-	35	35
Ø30	37	-	37	37
Ø32	40	-	40	40

a) Both of the two given values can be used

## Setting instructions

\*For detailed information on installation see instruction for use given with the package of the product,



### Safety regulations,

Review the Material Safety Data Sheet (MSDS) before use for proper and safe handling! Wear well-fitting protective goggles and protective gloves when working with Hilti HIT-RE 100,

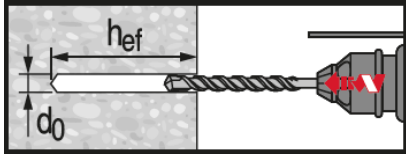

### Hammer drilled hole

For dry and wet concrete,

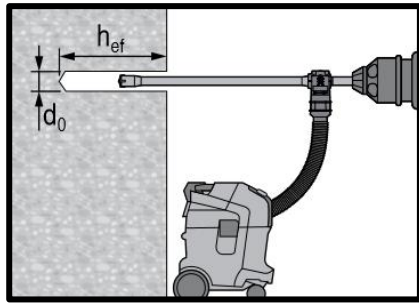

### Hammer drilled hole with Hollow Drilled Bit (HDB)

No cleaning required,

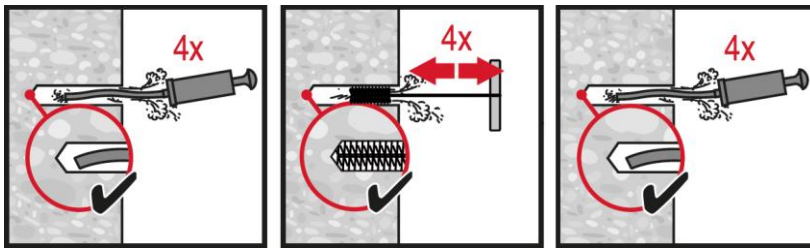

### Manual cleaning (MC) Non-cracked concrete only

for drill diameters  $d_0 \leq 20$  mm and drill hole depth  $h_0 \leq 10 \cdot d_0$ ,

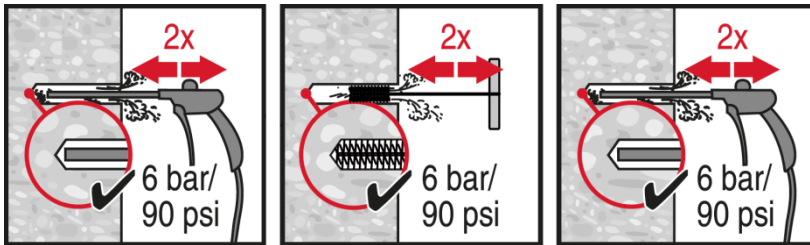

### Hammer Drilling:

#### Compressed air cleaning (CAC)

for all drill hole diameters  $d_0$  and drill hole depths  $h_0 \leq 20 \cdot d_0$ ,

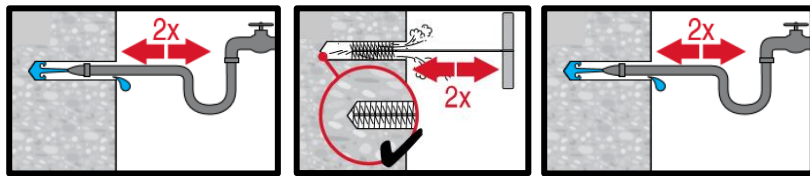

### Compressed air cleaning (CAC) cleaning of flooded holes

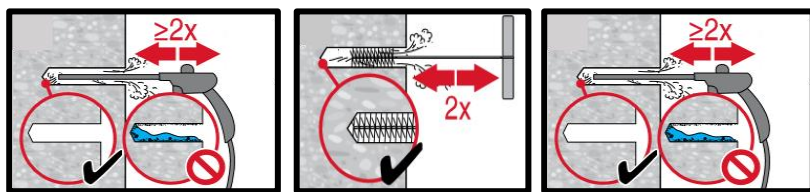

for all drill hole diameters  $d_0$  and drill hole depths  $h_0$ ,

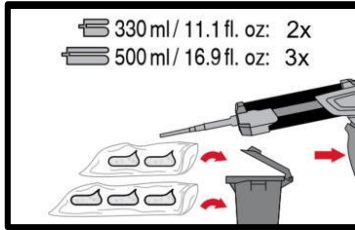
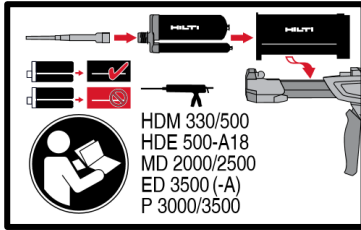

Injection system preparation,

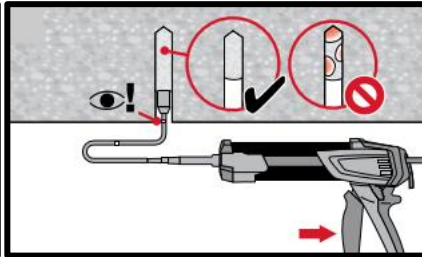
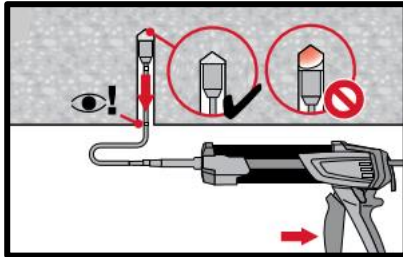

Injection method for overhead application and/or installation with embedment depth  $h_{ef} \leq 250$  mm

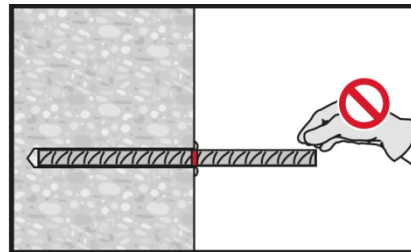
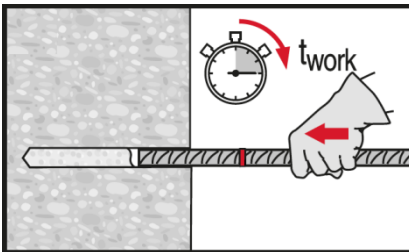

Setting element, observe working time " $t_{work}$ ",

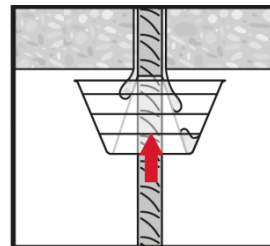
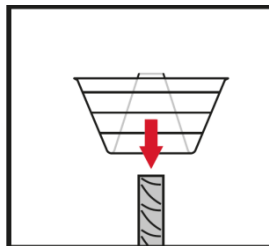
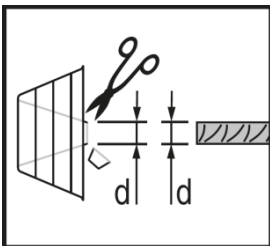

Setting element for overhead applications, observe working time " $t_{work}$ ",

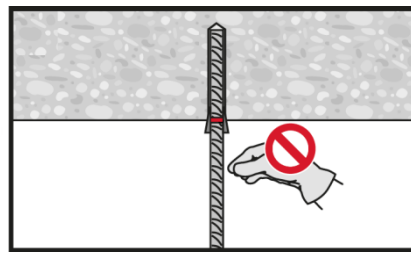
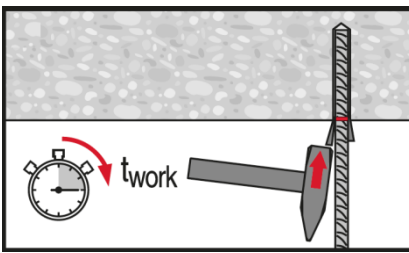



# HIT-RE 100 injection mortar

Rebar design (EN 1992-1) / Rebar elements / Concrete

Concrete

Chemical anchors

Mechanical anchors

Plastic/Light duty metal anchors

Insulation anchors

**Injection mortar system** **Benefits**



Hilti HIT-RE 100  
330 ml foil pack  
(also available as  
500 ml and 1400  
ml foil pack)

- Suitable for concrete C 12/15 to C 50/60
- High loading capacity
- Suitable for dry and water saturated concrete
- For rebar diameters up to 40 mm
- Non corrosive to rebar elements
- Long working time at elevated temperatures
- Suitable for embedment length till 3200 mm



Rebar B500 B  
( $\phi 8 - \phi 40$ )

**Base material** **Load conditions**

Concrete (non-cracked)	Concrete (cracked)	Dry concrete	Wet concrete	Static/ quasi-static	Fire resistance

**Installation conditions** **Other information**

Hammer drilling	Diamond coring	European Technical Assessment	CE conformity

**Approvals / certificates**

Description	Authority / Laboratory	No, / date of issue
European technical assessment <sup>a)</sup>	DIBt, Berlin	ETA – 15/0883 / 2017-12-06
Fire report	MFPA, Leipzig	GS 3,2/15-431-4 / 2016-04-29

c) All data given in this section according to the approvals mentioned above ETA-15/0883 issue 2017-12-06,



## Basic design data

### Static EC2 design

Design bond strength in N/mm<sup>2</sup> according to ETA 15/0883 for good bond conditions

Rebar-size	Concrete class								
	C12/15	C16/20	C20/25	C25/30	C30/37	C35/45	C40/50	C45/55	C50/60
<b>All allowed hammer drilling methods</b>									
φ8 - φ32	1,6	2,0	2,3	2,7	3,0	3,4	3,7	4,0	4,3
φ34	1,6	2,0	2,3	2,6	2,9	3,3	3,6	3,9	4,2
φ36	1,5	1,9	2,2	2,6	2,9	3,3	3,6	3,8	4,1
φ40	1,5	1,8	2,1	2,5	2,8	3,1	3,4	3,7	4,0
<b>Diamond coring wet</b>									
φ8 - φ32	1,6	2,0	2,3	2,7					
φ34	1,6	2,0	2,3	2,6					
φ36	1,5	1,9	2,2	2,6					
φ40	1,5	1,8	2,1	2,5					

For poor bond conditions multiply the values by 0,7, Values valid for non-cracked and cracked concrete

### Minimum anchorage length and minimum lap length

The minimum anchorage length  $l_{b,min}$  and the minimum overlap length  $l_{0,min}$  according to EN 1992-1-1 shall be multiplied by the relevant **Amplification factor** in the table below,

**Amplification factor  $\alpha_{lb}$  for the min, anchorage length and min, lap length according to EN 1992-1-1 for:**

Rebar - size	Concrete class								
	C12/15	C16/20	C20/25	C25/30	C30/37	C35/45	C40/50	C45/55	C50/60
<b>All allowed hammer drilling methods</b>									
φ8 - φ40	1,0								
<b>Diamond coring dry and wet</b>									
φ8 - φ40	1,5								

### Pre-calculated values<sup>1)</sup> – anchorage length

Rebar yield strength  $f_{yk}=500$  N/mm<sup>2</sup>, concrete C25/30, good bond conditions

Rebar-size	Anchorage length	Design value	Mortar volume <sup>2)</sup>	Anchorage length	Design value	Mortar volume <sup>2)</sup>	
	$l_{bd}$ [mm]	$N_{Rd}$ [KN]	$V_M$ [ml]		$l_{bd}$ [mm]	$N_{Rd}$ [KN]	$V_M$ [ml]
$\alpha_1=\alpha_2=\alpha_3=\alpha_4=\alpha_5=1,0$							
φ8	100	6,8	8	100	9,7	8	
	170	11,5	13		140	13,6	11
	250	17,0	19		180	17,4	14
	<b>322,1</b>	21,9	24		<b>225,4</b>	21,9	17
φ10	121	10,3	11	121	14,7	11	
	220	18,7	20	170	20,6	15	
	310	26,3	28	230	27,9	21	
	<b>402,6</b>	34,1	36	<b>281,8</b>	34,1	25	
φ12	145	14,8	15	145	21,1	15	
	260	26,5	27	210	30,5	22	
	370	37,7	39	270	39,3	29	
	<b>483,1</b>	49,2	51	<b>338,2</b>	49,2	36	
φ14	169	20,1	20	169	28,7	20	
	300	35,6	36	240	40,7	29	
	430	51,1	52	320	54,3	39	
	<b>563,6</b>	66,9	68	<b>394,5</b>	66,9	48	

**Pre-calculated values<sup>1)</sup> – anchorage length**

Rebar yield strength  $f_{yk}=500$  N/mm<sup>2</sup>, concrete C25/30, good bond conditions

Rebar-size	Anchorage length	Design value	Mortar volume <sup>2)</sup>	Anchorage length	Design value	Mortar volume <sup>2)</sup>
	$l_{bd}$ [mm]	$N_{Rd}$ [KN]	$V_M$ [ml]		$l_{bd}$ [mm]	$N_{Rd}$ [KN]
	$\alpha_1=\alpha_2=\alpha_3=\alpha_4=\alpha_5=1,0$				$\alpha_1=\alpha_3=\alpha_4=1,0 \quad \alpha_2 \text{ or } \alpha_5=0,7$	
φ16	193	26,2	26	193	37,4	26
	340	46,1	46	280	54,3	38
	490	66,5	67	370	71,7	50
	<b>644</b>	87,4	87	<b>450,9</b>	87,4	61
φ18	217	33,1	33	217	47,3	33
	380	58	57	310	67,6	47
	540	82,4	81	410	89,4	62
	<b>724,6</b>	110,6	109	<b>507,2</b>	110,6	76
φ20	242	41,1	51	242	58,6	51
	390	66,2	83	350	84,8	74
	550	93,3	117	460	111,5	98
	<b>805,2</b>	136,6	171	<b>563,6</b>	136,6	120
φ22	266	49,6	75	266	70,9	75
	410	76,5	116	380	101,3	107
	560	104,5	158	500	133,3	141
	<b>885,7</b>	165,3	250	<b>620</b>	165,3	175
φ24	290	59	122	290	84,3	122
	430	87,5	182	420	122,1	177
	560	114	236	550	160	232
	<b>966,2</b>	196,7	408	<b>676,3</b>	196,7	286
φ25	302	64	114	302	91,5	114
	430	91,2	162	430	130,3	162
	570	120,9	214	570	172,7	214
	<b>1006,4</b>	213,4	378	<b>704,5</b>	213,4	265
φ28	350	83,1	145	338	114,7	140
	595	141,3	247	480	162,9	200
	875	207,8	364	635	215,5	264
	<b>1127,2</b>	267,7	469	<b>789</b>	267,7	328
φ30	374	95,2	165	374	136	165
	635	161,6	281	528	191,9	233
	935	237,9	413	700	254,5	309
	<b>1207,7</b>	307,3	534	<b>845,4</b>	307,3	374
φ32	400	108,6	217	400	155,1	217
	680	184,6	369	580	224,9	315
	1000	271,4	543	800	310,2	434
	<b>1288,2</b>	349,7	699	<b>901,8</b>	349,7	490
φ36	450	132,3	387	440	184,8	379
	765	225	658	640	268,8	551
	1125	330,8	968	900	378,1	774
	<b>1505,0</b>	442,6	1295	<b>1053,5</b>	442,6	907
φ40	500	157,1	520	485	217,7	505
	850	267	884	700	314,2	728
	1000	314,2	1040	990	444,3	1030
	<b>1739,1</b>	546,4	1810	<b>1217,4</b>	546,4	1267

1) Values corresponding to the minimum anchorage length, The maximum permissible load is valid for "good bond conditions" as described in EN 1992-1-1, For all other conditions multiply by the value by 0,7,

2) The volume of mortar corresponds to the formula " $1,2 \cdot (d_o^2 - d_s^2) \cdot \pi \cdot l_b / 4$ " for hammer drilling

**Pre-calculated values – overlap length**

Rebar yield strength  $f_{yk}=500 \text{ N/mm}^2$ , concrete c25/30, good bond conditions

Rebar-size	Overlap length	Design value	Mortar volume <sup>2)</sup>	Overlap length	Design value	Mortar volume <sup>2)</sup>
	$l_0$ [mm]	$N_{Rd}$ [KN]	$V_M$ [ml]		$l_0$ [mm]	$N_{Rd}$ [KN]
$\alpha_1=\alpha_2=\alpha_3=\alpha_4=\alpha_5=1,0$				$\alpha_1=\alpha_3=\alpha_4=1,0 \quad \alpha_2 \text{ or } \alpha_5=0,7$		
φ8	200	13,6	15	200	19,4	15
	240	16,3	18	210	20,4	16
	280	19	21	220	21,3	17
	<b>322,1</b>	21,9	24	<b>225,4</b>	21,9	17
φ10	200	17	18	200	24,2	18
	270	22,9	24	230	27,9	21
	340	28,8	31	250	30,3	23
	<b>402,6</b>	34,1	36	<b>281,8</b>	34,1	25
φ12	200	20,4	21	200	29,1	21
	290	29,5	31	250	36,4	26
	390	39,7	41	290	42,2	31
	<b>483,1</b>	49,2	51	<b>338,2</b>	49,2	36
φ14	210	24,9	25	210	35,6	25
	330	39,2	40	270	45,8	33
	450	53,4	54	330	56	40
	<b>563,6</b>	66,9	68	<b>394,5</b>	66,9	48
φ16	240	32,6	33	240	46,5	33
	370	50,2	50	310	60,1	42
	510	69,2	69	380	73,7	52
	<b>644</b>	87,4	87	<b>450,9</b>	87,4	61
φ18	270	41,2	41	270	58,9	41
	410	62,6	62	350	76,3	53
	560	85,5	84	430	93,8	65
	<b>724,6</b>	110,6	109	<b>507,2</b>	110,6	76
φ20	300	50,9	64	300	72,7	64
	430	72,9	91	390	94,5	83
	570	96,7	121	480	116,3	102
	<b>805,2</b>	136,6	171	<b>563,6</b>	136,6	120
φ22	330	61,6	93	330	88	93
	450	84	127	430	114,6	122
	580	108,2	164	520	138,6	147
	<b>885,7</b>	165,3	250	<b>620</b>	165,3	175
φ24	360	73,3	152	360	104,7	152
	470	95,7	198	470	136,7	198
	590	120,1	249	570	165,8	241
	<b>966,2</b>	196,7	408	<b>676,3</b>	196,7	286
φ25	375	79,5	141	375	113,6	141
	430	91,2	162	480	145,4	181
	570	120,9	214	590	178,7	222
	<b>1006,4</b>	213,4	378	<b>704,5</b>	213,4	265
φ28	420	99,8	175	420	142,5	175
	595	141,3	247	530	179,8	220
	875	207,8	364	635	215,5	264
	<b>1127,2</b>	267,7	469	<b>789</b>	267,7	328

Concrete

Chemical anchors

Mechanical anchors

Plastic/Light duty metal anchors

Insulation anchors

### Pre-calculated values – overlap length

Rebar yield strength  $f_{yk}=500 \text{ N/mm}^2$ , concrete c25/30, good bond conditions

Rebar-size	Overlap length	Design value	Mortar volume <sup>2)</sup>	Overlap length	Design value	Mortar volume <sup>2)</sup>
	$l_0$ [mm]	$N_{Rd}$ [KN]	$V_M$ [ml]		$l_0$ [mm]	$N_{Rd}$ [KN]
	$\alpha_1=\alpha_2=\alpha_3=\alpha_4=\alpha_5=1,0$			$\alpha_1=\alpha_3=\alpha_4=1,0 \quad \alpha_2 \text{ or } \alpha_5=0,7$		
$\phi 30$	450	114,5	199	450	163,6	199
	635	161,6	281	528	191,9	233
	935	237,9	413	700	254,5	309
	<b>1207,7</b>	<b>307,3</b>	<b>534</b>	<b>845,4</b>	<b>307,3</b>	<b>374</b>
$\phi 32$	480	130,3	261	480	186,1	261
	680	184,6	369	650	252	353
	1000	271,4	543	800	310,2	434
	<b>1288,2</b>	<b>349,7</b>	<b>699</b>	<b>901,8</b>	<b>349,7</b>	<b>490</b>
$\phi 36$	540	158,8	465	540	218,1	465
	765	225,0	658	720	290,0	620
	1125	330,8	968	900	363,5	774
	<b>1505,0</b>	<b>442,6</b>	<b>1295</b>	<b>1053,5</b>	<b>442,6</b>	<b>907</b>
$\phi 40$	600	188,5	624	600	269,3	624
	850	267,0	884	750	336,6	780
	1000	314,2	1040	990	444,3	1030
	<b>1739,1</b>	<b>505,9</b>	<b>1676</b>	<b>1217,4</b>	<b>546,4</b>	<b>1267</b>

- 1) Values corresponding to the minimum anchorage length, The maximum permissible load is valid for "good bond conditions" as described in EN 1992-1-1, For all other conditions multiply by the value by 0,7,
- 2) The volume of mortar corresponds to the formula " $1,2 \cdot (d_o^2 - d_s^2) \cdot \pi \cdot l_b / 4$ " for hammer drilling

### Fire resistance

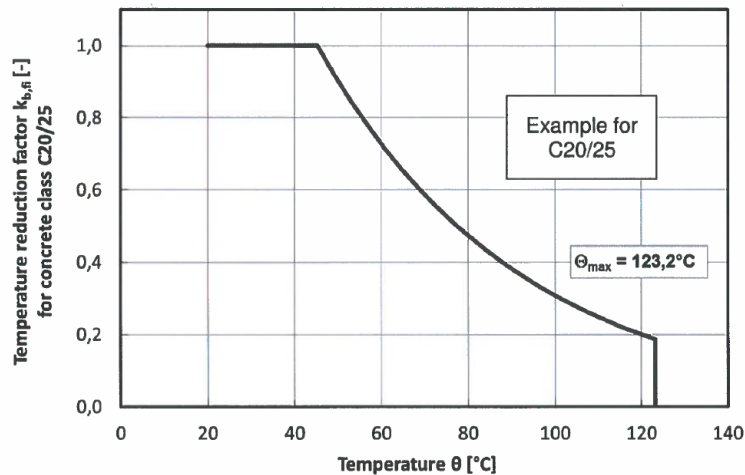

The design value of the bond strength  $f_{bd,fi}$  under fire exposure has to be calculated by the following equation:

$$f_{bd,fi} = k_{b,fi}(\theta) \cdot f_{bd} \cdot \gamma_c / \gamma_{M,fi}$$

With:  $\theta \leq 123,2^\circ\text{C}$ :  $k_{b,fi}(\theta) = 26,424 \cdot e^{-0,0215 \cdot \theta} / f_{bd} \cdot 4,3 \leq 1,0$   
 $\theta > 123,2^\circ\text{C}$ :  $k_{b,fi}(\theta) = 0,0$

$f_{bd,fi}$  design value of the ultimate bond stress in case of fire in  $\text{N/mm}^2$   
 $\theta$  temperature in  $^\circ\text{C}$  in the mortar layer  
 $k_{b,fi}(\theta)$  reduction factor under fire exposure  
 $f_{bd}$  design values of the ultimate bond stress in  $\text{N/mm}^2$  in cold condition  
 $\gamma_c$  partially safety factor according to EN 1992-1-1  
 $\gamma_{M,fi}$  partially safety factor according to EN 1992-1-2

a) Anchoring application

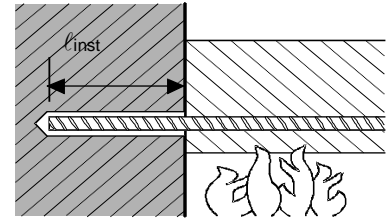

Anchoring application beam-wall connections with a concrete cover of 20 mm

Maximum force ( $F_{s,T,max}$ ) in rebar in conjunction with HIT-RE 100 as a function of embedment depth ( $l_{inst}$ ) for the fire resistance classes F30 to F240 according to EC2,

Rebar-size	$F_{s,T,max}$ [kN]	$l_{inst}$ [mm]	Fire resistance of bar [kN]						
			R30	R60	R90	R120	R180	R240	
$\phi 8$	16,8	100	3,4	1,0	0,2	-	-	-	
		110	4,3	1,7	0,5	-	-	-	
		140	6,9	4,2	2,2	0,9	-	-	
		160	8,6	6,0	3,9	2,1	0,5	-	
		260	16,8	16,8	14,6	12,5	10,7	7,7	5,3
		290			15,1	13,3	10,3	7,9	
		310			15,1	12,1	9,6		
		330			16,8	13,8	11,4		
		370				16,8	14,8		
		400			16,8	16,8			
$\phi 10$	26,2	110	5,3	2,1	0,6	-	-	-	
		140	8,6	5,3	2,7	1,2	-	-	
		160	10,8	7,4	4,8	2,7	0,6	-	
		260	21,6	18,3	15,7	13,4	9,7	6,6	
		290	24,8	21,5	18,9	16,7	12,9	9,9	
		310	26,2	26,2	23,7	21,1	18,8	15,1	12,0
		340			24,3	22,1	18,3	15,3	
		360			26,2	24,2	20,5	17,5	
		380			26,2	26,2	22,7	19,6	
		450			26,2	26,2	26,2	26,2	
450	26,2	26,2			26,2	26,2			
$\phi 12$	37,7	130	9,0	5,0	2,2	0,8	-	-	
		140	10,3	6,3	3,2	1,4	-	-	
		160	12,9	8,9	5,8	3,2	0,8	-	
		260	25,9	21,9	18,8	16,1	11,6	7,9	
		360	37,7	37,7	35,0	31,8	29,1	24,6	20,9
		390			35,7	33,0	28,5	24,8	
		450			37,7	37,7	36,3	32,6	
		500			37,7	37,7	37,7	37,7	
$\phi 14$	51,3	160	15,1	10,4	6,8	3,7	0,9	-	
		260	30,2	25,6	21,9	18,8	13,5	9,3	
		360	45,4	40,8	37,1	33,9	28,7	24,4	
		400	51,3	51,3	46,8	43,2	40,0	34,8	30,5
		450			50,8	47,6	42,4	38,1	
		500			51,3	51,3	50,0	45,7	
		550			51,3	51,3	51,3	51,3	

Maximum force ( $F_{s,T,max}$ ) in rebar in conjunction with HIT-RE 100 as a function of embedment depth ( $l_{inst}$ ) for the fire resistance classes F30 to F240 according to EC2,

Rebar-size	$F_{s,T,max}$ [kN]	$l_{inst}$ [mm]	Fire resistance of bar [kN]						
			R30	R60	R90	R120	R180	R240	
φ16	67,0	180	20,7	15,4	11,2	7,6	2,7	0,9	
		260	34,5	29,3	25,1	21,5	15,5	10,6	
		360	51,9	46,6	42,4	38,8	32,8	27,9	
		450	67,0	67,0	62,2	58,0	54,4	48,4	43,5
		500			66,7	63,1	57,1	52,2	
		550			67,0	67,0	65,8	60,9	
		600			67,0	67,0	67,0	67,0	67,0
φ18	84,8	200	27,2	21,2	16,5	12,4	5,9	2,6	
		260	38,9	32,9	28,2	24,1	17,4	11,9	
		360	58,4	52,4	47,7	43,6	36,9	31,4	
		500	84,8	84,8	79,7	75,0	71,0	64,2	58,7
		550			80,7	74,0	68,5		
		600			84,8	84,8	84,8	83,8	78,2
		650				84,8	84,8	84,8	84,8
φ20	104,7	220	34,5	27,9	22,7	18,2	10,7	5,5	
		260	43,2	36,6	31,3	26,8	19,4	13,2	
		360	64,9	58,3	53,0	48,5	41,0	34,9	
		550	104,7	104,7	99,4	94,2	89,7	82,2	76,1
		600			104,7	100,5	93,1	86,9	
		650			104,7	104,7	103,9	97,8	
		700				104,7	104,7	104,7	104,7
φ22	126,7	240	42,7	35,5	29,7	24,7	16,5	9,9	
		360	71,3	64,1	58,3	53,3	45,1	38,4	
		500	104,7	97,5	91,7	86,7	78,5	71,8	
		600	126,7	126,7	121,3	115,5	110,6	102,4	95,6
		650			122,5	114,3	107,5		
		700			126,7	126,7	126,7	126,2	119,5
		750				126,7	126,7	126,7	126,7
φ24	150,8	270	54,4	46,5	40,2	34,8	25,8	18,5	
		360	77,8	69,9	63,6	58,2	49,2	41,9	
		650	150,8	150,8	145,3	139,1	133,6	124,7	117,3
		700			146,6	137,7	130,3		
		750			150,8	150,8	150,8	150,7	143,3
		800				150,8	150,8	150,8	150,8
φ25	163,6	280	59,4	51,1	44,6	38,9	29,6	22,0	
		360	81,1	72,8	66,3	60,6	51,3	43,6	
		700	163,6	163,6	158,4	152,8	143,4	135,8	
		750			157,0	149,3			
		800			163,6	163,6	163,6	163,6	162,9
		850				163,6	163,6	163,6	163,6
φ26	177,0	290	64,6	56,0	49,2	43,3	33,6	25,6	
		360	84,3	75,7	68,9	63,0	53,3	45,4	
		700	177,0	177,0	171,5	164,7	158,9	149,2	141,2
		750			173,0	163,2	155,3		
		800			177,0	177,0	177,0	177,0	169,4
		850				177,0	177,0	177,0	177,0
φ27	190,9	300	70,0	61,1	54,0	47,9	37,8	29,6	
		500	128,5	119,6	112,5	106,4	96,4	88,1	
		750	190,9	190,9	185,7	179,6	169,5	161,2	
		800			184,2	175,9			
		850			190,9	190,9	190,9	190,9	190,5
		900				190,9	190,9	190,9	190,9
φ28	205,3	300	75,6	66,4	59,0	52,7	42,3	33,7	
		500	133,3	124,0	116,7	110,4	99,9	91,3	
		750	205,3	205,3	199,9	192,6	186,3	175,8	167,2
		800			201,4	191,0	182,4		
		850			205,3	205,3	205,3	205,3	197,6
		900				205,3	205,3	205,3	205,3

Concrete  
Chemical anchors  
Mechanical anchors  
Plastic/Light duty metal anchors  
Insulation anchors

Maximum force ( $F_{s,T,max}$ ) in rebar in conjunction with HIT-RE 100 as a function of embedment depth ( $l_{inst}$ ) for the fire resistance classes F30 to F240 according to EC2,

Rebar-size	$F_{s,T,max}$ [kN]	$l_{inst}$ [mm]	Fire resistance of bar [kN]					
			R30	R60	R90	R120	R180	R240
$\phi 30$	235,6	330	87,5	77,6	69,8	63,0	51,8	42,6
		500	142,8	132,9	125,0	118,3	107,1	97,9
		800	235,6	230,4	222,6	215,8	204,6	195,4
		850		235,6	235,6	235,6	232,1	220,9
		900	227,9					
		950	235,6					
$\phi 32$	268,1	350	100,3	89,7	81,4	74,1	62,2	
		500	152,3	141,8	133,4	126,2	114,2	104,4
		850	268,1	263,2	254,8	247,5	235,6	225,8
		900		268,1	268,1	264,9	252,9	243,1
		950	268,1	268,1	268,1	268,1	260,5	
		$\phi 34$	302,6	370	113,9	102,7	93,8	86,1
500	161,8			150,6	141,7	134,0	121,3	110,9
900	302,6			298,0	289,1	281,4	268,8	258,3
950				302,6	302,6	299,9	287,2	276,8
$\phi 36$	339,3			400	132,3	120,5	111,0	102,9
		600	210,4	198,5	189,1	180,9	167,5	156,5
		800	288,4	276,5	267,1	259,0	245,5	234,5
		950	339,3	335,1	325,6	317,5	304,1	293,0
		$\phi 40$	385,5	450	168,7	155,5	145,1	136,0
600	233,8			220,6	210,1	201,0	186,1	173,9
800	320,5			307,3	296,8	287,8	272,8	260,6
950	385,5			372,3	361,8	352,8	337,9	325,6

\*For additional values please check GS 3,2/15-431-4 fire report, Characteristic yield strength  $f_{yk} = 500 \text{ N/mm}^2$

Steel failure

### b) Overlap joint application

Max, bond stress,  $f_{bd,FIRE}$ , depending on actual clear concrete cover for classifying the fire resistance,

It must be verified that the actual force in the bar during a fire,  $F_{s,T}$ , can be taken up by the bar connection of the selected length,  $l_{inst}$ , Note: Cold design for ULS is mandatory,

$$F_{s,T} \leq (l_{inst} - c_f) \cdot \phi \cdot \pi \cdot f_{bd,FIRE} \quad \text{where: } (l_{inst} - c_f) \geq l_s;$$

$l_s$  = lap length

$\phi$  = nominal diameter of bar

$l_{inst} - c_f$  = selected overlap joint length; this must be at least  $l_s$ ,

but may not be assumed to be more than  $80 \phi$

$f_{bd,FIRE}$  = bond stress when exposed to fire

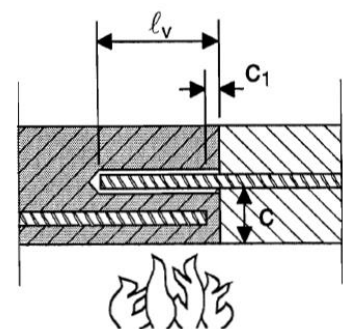

Critical temperature-dependent bond stress,  $f_{bd,FIRE}$ , concerning "overlap joint" for Hilti HIT-RE 100 injection adhesive in relation to fire resistance class and required minimum concrete coverage  $c$ ,

Clear concrete cover $c$ [mm]	Max, bond stress, $\tau_c$ [N/mm <sup>2</sup> ]					
	R30	R60	R90	R120	R180	R240
50	0,9					
60	1,7					
70	2,7					
80	3,5	1,0				
90		1,6				
100		2,3	1,0			
110		3,0	1,4			



Critical temperature-dependent bond stress,  $f_{bd, FIRE}$ , concerning “overlap joint” for Hilti HIT-RE 100 injection adhesive in relation to fire resistance class and required minimum concrete coverage  $c$ ,

Clear concrete cover $c$ [mm]	Max, bond stress, $\tau_c$ [N/mm <sup>2</sup> ]					
	R30	R60	R90	R120	R180	R240
120			1,9	1,0		
130			2,5	1,4		
140			3,1	1,9	0,7	
150				2,4	1,0	
160				2,9	1,3	
170				3,4	1,7	0,9
180					2,1	1,1
190		3,5			2,5	1,4
200			3,5		2,9	1,7
210					3,3	2,1
220				3,5		2,5
230						2,8
240					3,5	3,1
250						
260						3,5

### Materials

#### Material quality

Part	Material
Rebar EN 1992-1-1:2004+AC:2010	Bars and de-coiled rods class B or C with $f_{yk}$ and $k$ according to NDP or NCL of EN 1992-1-1/NA:2013 $f_{uk} = f_{tk} = k \cdot f_{yk}$

### Fitness for use

Some creep tests have been conducted in accordance with ETAG guideline 001 part 5 and TR 023 in the following conditions: **in dry environment at 50 °C during 90 days,**

These tests show an excellent behaviour of the post-installed connection made with HIT-RE 100: low displacements with long term stability, failure load after exposure above reference load,

### Resistance to chemical substances

Chemical	Resistance	Chemical	Resistance
Acetic acid 100%	o	Methanol 100%	o
Acetic acid 10%	+	Peroxide of hydrogen 30%	o
Hydrochloric Acid 20%	+	Solution of phenol (sat,)	-
Nitric Acid 40%	-	Sodium hydroxide pH=14	+
Phosphoric Acid 40%	+	Solution of chlorine (sat,)	+
Sulphuric acid 40%	+	Solution of hydrocarbons (60 % vol Toluene, 30 % vol Xylene, 10 % vol Methyl naphthalene)	+
Ethyl acetate 100%	o	Salted solution 10%	+
Acetone 100%	-	sodium chloride	
Ammoniac 5%	o	Suspension of concrete (sat,)	+
Diesel 100%	+	Chloroform 100%	+
Gasoline 100%	+	Xylene 100%	+
Ethanol 96%	o		
Machine oils 100%	+		

- + resistant
- o resistant in short term (max, 48h) contact

- not resistant

### Electrical Conductivity

HIT-RE 100 in the hardened state is **not conductive electrically**, Its electric resistivity is  $1,4 \cdot 10^{10} \Omega \cdot m$  (DIN IEC 93 – 12,93), It is adapted well to realize electrically insulating anchorings (ex: railway applications, subway),

### Installation temperature range:

+5°C to +40°C

### Service temperature range

Hilti HIT-RE 100 injection mortar may be applied in the temperature ranges given below, An elevated base material temperature may lead to a reduction of the design bond resistance,

Temperature range	Base material temperature	Maximum long term base material temperature	Maximum short term base material temperature
Temperature range I	-40 °C to +80 °C	+50 °C	+80 °C

### Max short term base material temperature

Short-term elevated base material temperatures are those that occur over brief intervals, e.g, as a result of diurnal cycling,

### Max long term base material temperature

Long-term elevated base material temperatures are roughly constant over significant periods of time,

### Working time and curing time<sup>a)</sup>

Temperature IN the base material $T_{BM}$	Maximum working time $t_{work}$	Initial curing time $t_{cure,ini}^{b)}$	Minimum curing time $t_{cure}$
$5\text{ °C} \leq T_{BM} < 9\text{ °C}$	2 hours	18 hours	72 hours
$10\text{ °C} \leq T_{BM} < 14\text{ °C}$	1,5 hours	12 hours	48 hours
$15\text{ °C} \leq T_{BM} < 19\text{ °C}$	30 min	8 hours	24 hours
$20\text{ °C} \leq T_{BM} < 24\text{ °C}$	25 min	6 hours	12 hours
$25\text{ °C} \leq T_{BM} < 29\text{ °C}$	20 min	5 hours	10 hours
$30\text{ °C} \leq T_{BM} \leq 39\text{ °C}$	12 min	4 hours	8 hours
40 °C	12 min	2 hours	4 hours

a) The curing time data are valid for dry base material only, In wet base material the curing times must be doubled,

b) After  $t_{cure,ini}$  has elapsed preparation work may continue

### Setting information

#### Installation equipment

Rebar – size	$\phi 8\text{-}\phi 16$	$\phi 18\text{-}\phi 40$
Rotary hammer	TE2(-A) – TE30(-A)	TE40 – TE80
Other tools	Blow out pump ( $h_{ef} \leq 10 \cdot d$ )	-
	Compressed air gun <sup>a)</sup> Set of cleaning brushes <sup>b)</sup> , dispenser, piston plug	

a) Compressed air gun with extension hose for all drill holes deeper than 250 mm (for  $\phi 8$  to  $\phi 12$ ) or deeper than  $20 \cdot \phi$  (for  $\phi > 12$  mm)

b) Automatic brushing with round brush for all drill holes deeper than 250 mm (for  $\phi 8$  to  $\phi 12$ ) or deeper than  $20 \cdot \phi$  (for  $\phi > 12$  mm)

**Minimum concrete cover  $c_{min}$  of the post-installed rebar**

Drilling method	Rebar – size [mm]	Minimum concrete cover $c_{min}$ [mm]	
		Without drilling aid	With drilling aid
Hammer drilling <b>(HD)</b>	$\phi < 25$	$30 + 0,06 \cdot l_v \geq 2 \cdot \phi$	$30 + 0,02 \cdot l_v \geq 2 \cdot \phi$
	$\phi \geq 25$	$40 + 0,06 \cdot l_v \geq 2 \cdot \phi$	$40 + 0,02 \cdot l_v \geq 2 \cdot \phi$
Compressed air drilling <b>(CA)</b>	$\phi < 25$	$50 + 0,08 \cdot l_v$	$50 + 0,02 \cdot l_v$
	$\phi \geq 25$	$60 + 0,08 \cdot l_v \geq 2 \cdot \phi$	$60 + 0,02 \cdot l_v \geq 2 \cdot \phi$
Diamond coring dry <b>(PCC)</b> or wet <b>(DD)</b>	$\phi < 25$	Drill stand is used as drilling aid	$30 + 0,02 \cdot l_v \geq 2 \cdot \phi$
	$\phi \geq 25$		$40 + 0,02 \cdot l_v \geq 2 \cdot \phi$

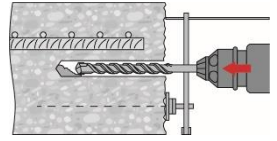
**Drilling and cleaning diameters**

Rebar [mm]	Drill bit diameters $d_0$ [mm]			Diamond core $d_0$ [mm]		Installation size [mm]	
	Hammer drill (HD)	Compressed air drill (CA)	Hollow Drill Bit (HDB)	Wet (DD)	Dry (PCC) <sup>b)</sup>	Brush HIT-RB	Air nozzle HIT-RB
$\phi 8$	12 (10 <sup>a)</sup> )	-	-	12 (10 <sup>a)</sup> )	-	12 (10 <sup>a)</sup> )	12 (10 <sup>a)</sup> )
$\phi 10$	14 (12 <sup>a)</sup> )	-	-	14 (12 <sup>a)</sup> )	-	14 (12 <sup>a)</sup> )	14 (12 <sup>a)</sup> )
$\phi 12$	16 (14 <sup>a)</sup> )	-	-	16 (14 <sup>a)</sup> )	-	16 (14 <sup>a)</sup> )	16 (14 <sup>a)</sup> )
	-	17	-	-	-	18	16
$\phi 14$	18	17	-	18	-	18	18
	20	-	-	20	-	20	20
$\phi 16$	-	20	-	-	-	22	20
	22	22	-	22	-	22	22
$\phi 20$	25 (24 <sup>a)</sup> )	-	-	25	-	25 (24 <sup>a)</sup> )	25 (24 <sup>a)</sup> )
	-	26	-	-	-	28	25
$\phi 22$	28	28	-	28	-	28	28
	32	32	-	32	-	32	32
$\phi 24$	-	-	35	-	35	-	
	32 (30 <sup>a)</sup> )	32 (30 <sup>a)</sup> )	-	32 (30 <sup>a)</sup> )	-	32 (30 <sup>a)</sup> )	
$\phi 25$	-	-	35	-	35	-	
	35	35	35	35	35	35	
$\phi 26$	35	35	35	35	35	35	
	35	35	35	35	35	35	
$\phi 28$	-	35	35	35	35	35	
	37	-	-	-		37	
$\phi 30$	40	40	47	40	47	40	
	-	42	-	42	47	42	
$\phi 32$	45	-	47	-		45	
	45	45	-	-	45		
$\phi 34$	-	-	47	47	47	47	
	52	-	52	52		52	
$\phi 36$	-	-	52	-	52	52	
	55	57	-	-		55	

- a) Both of a given values can be used,  
b) No cleaning required,

Dispenser and corresponding maximum embedment depth  $l_{v,max}$

Rebar	Dispenser	
	HDM 330, HDM 500	HDE 500
	$l_{v,max}$ [mm]	
$\phi 8$ to $\phi 10$	1000	1000
$\phi 12$ to $\phi 14$		1200
$\phi 16$		1500
$\phi 18$ to $\phi 20$	700	1300
$\phi 22$ to $\phi 25$		1000
$\phi 26$ to $\phi 28$	500	700
$\phi 30$ to $\phi 32$		
$\phi 34$ to $\phi 40$	-	500

Concrete

Chemical anchors

Mechanical anchors

Plastic/Light duty metal anchors

Insulation anchors

## Setting instructions

\*For detailed information on installation see instruction for use given with the package of the product,



### Safety regulations,

Review the Material Safety Data Sheet (MSDS) before use for proper and safe handling! Wear well-fitting protective goggles and protective gloves when working with Hilti HIT-RE 100,

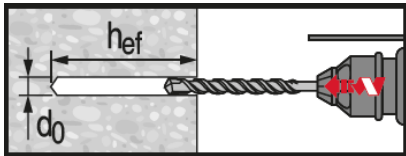

### Hammer drilled hole

For dry and wet concrete,

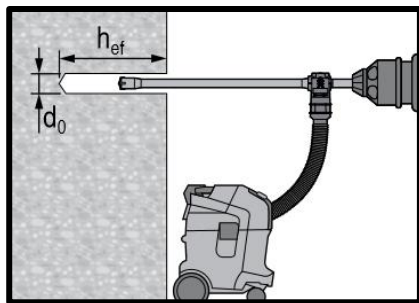

### Hammer drilled hole with Hollow Drilled Bit (HDB)

No cleaning required,

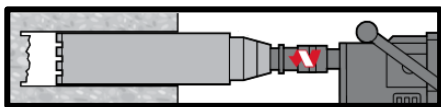

### Diamond Drilling (DD)

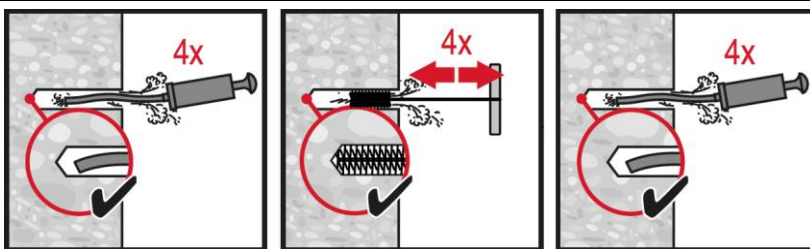

### Hammer Drilling:

#### Manual cleaning (MC)

for drill diameters  $d_0 \leq 20$  mm and drill hole depth  $h_0 \leq 10 \cdot d$ ,

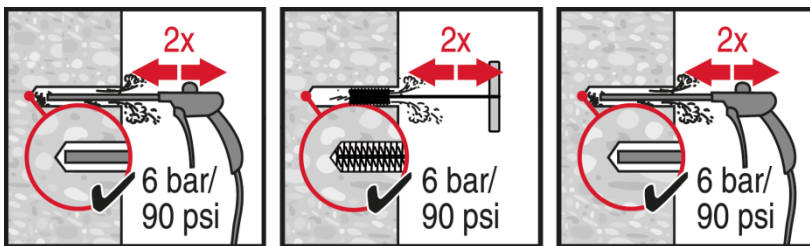

### Hammer Drilling:

#### Compressed air cleaning (CAC)

for all drill hole diameters  $d_0$  and drill hole depths  $h_0 \leq 20 \cdot d$ ,

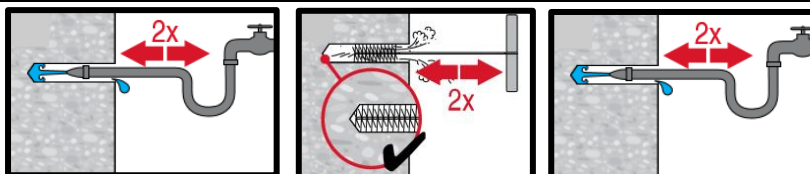

### Wet diamond coring:

#### Compressed air cleaning (CAC)

for all drill hole diameters  $d_0$  and drill hole depths  $h_0$ ,

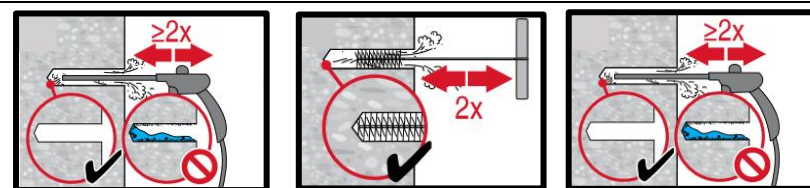

### Dry diamond coring:

#### Compressed air cleaning (CAC)

for all drill hole diameters  $d_0$  and drill hole depths  $h_0$ ,

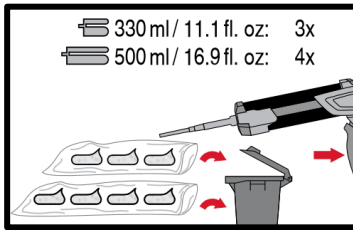
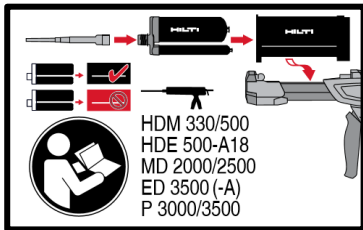

Injection system preparation,

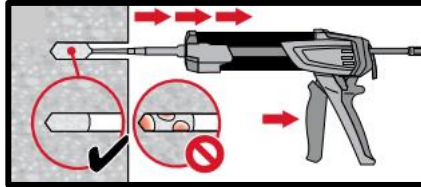

Injection method for drill hole depth  
 $h_{ef} \leq 250$  mm,

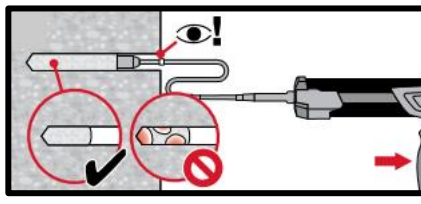
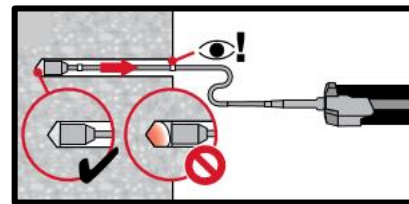

Injection method for drill hole depth  
 $h_{ef} > 250$  mm,

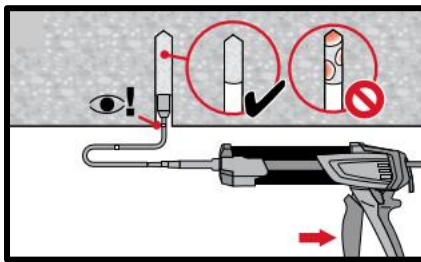
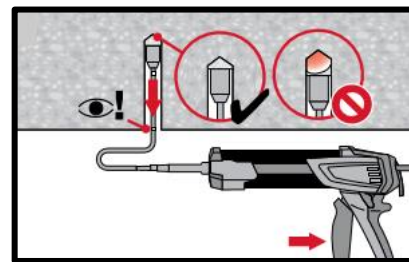

Injection method for overhead  
application,

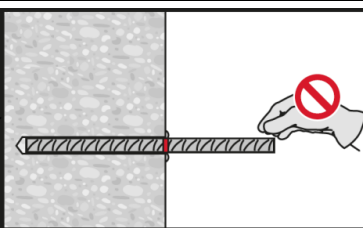
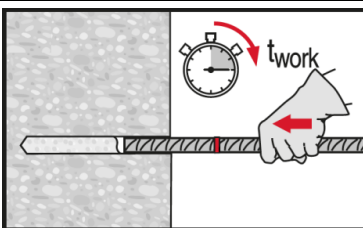

Setting element, observe working time  
“ $t_{work}$ ”,

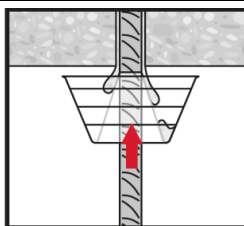
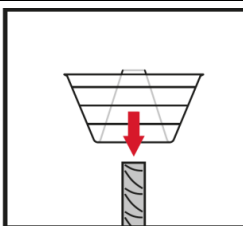
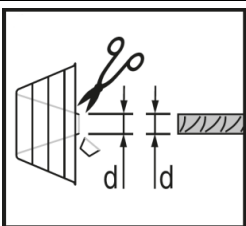

Setting element for overhead  
applications, observe working time “ $t_{work}$ ”,

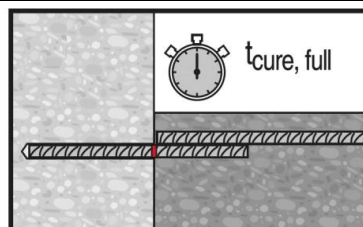
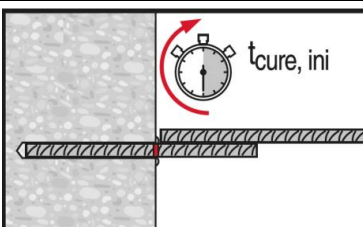
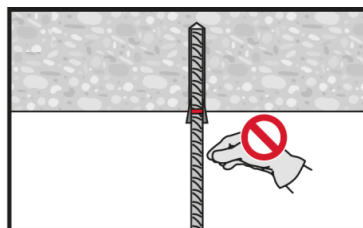
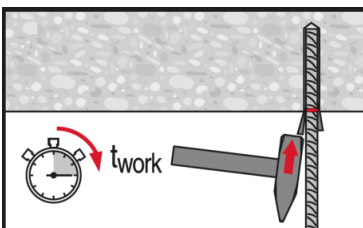

Apply full load only after curing time  
“ $t_{cure}$ ”,



# HIT-RE 100-HC injection mortar

Anchor design (EN 1992-4) / Rods&Sleeves / Concrete

## Injection mortar system



Hilti HIT-RE 100-HC  
580 ml hard cartridge



Anchor rods:  
HAS-U  
HAS-U HDG  
HAS-U A4  
HAS-U HCR  
(M8-M30)

## Benefits

- Suitable for cracked and uncracked concrete C 20/25 to C 50/60
- High loading capacity
- Suitable for dry and water saturated concrete
- Large diameter applications
- Long working time at elevated temperatures
- Odourless epoxy

## Base material



Concrete (uncracked)



Concrete (cracked)



Dry concrete



Wet concrete



Static/  
quasi-static

## Load conditions

## Installation conditions

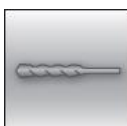

Hammer drilling

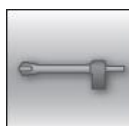

Hollow drill-bit drilling

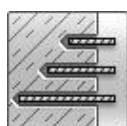

Variable embedment depth

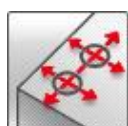

Small edge distance and spacing

## Other informations



European Technical Assessment



CE conformity

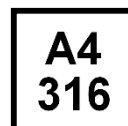

Corrosion resistance



High corrosion resistance

## Approvals / certificates

Description	Authority / Laboratory	No. / date of issue
European technical assessment <sup>a)</sup>	DIBt, Berlin	ETA-19/0148 / 2019-12-13

<sup>a)</sup> All data given in this section according to ETA-19/0148, issue 2019-12-13.



## Static and quasi-static loading (for a single anchor)

### All data in this section applies to

- Correct setting (See setting instruction)
- No edge distance and spacing influence
- Steel failure
- Anchor HAS-U with strength 5.8
- Base material thickness, as specified in the table
- One typical embedment depth, as specified in the table
- Concrete C 20/25,  $f_{ck,cube} = 25 \text{ N/mm}^2$
- Temperate range I  
(min. base material temperature  $-40^\circ\text{C}$ , max. long term/short term base material temperature:  $+24^\circ\text{C}/40^\circ\text{C}$ )

### Embedment depth and base material thickness

Anchor size	ETA-19/0148, issue 2019-12-13								Hilti technical data		
	M8	M10	M12	M16	M20	M24	M27	M30	M33	M36	M39
HAS-U											
Eff. anchorage depth [mm]	80	90	110	125	170	210	240	270	300	330	360
Base material thickness [mm]	110	120	140	160	220	270	300	340	380	410	450

### Characteristic resistance

Anchor size	ETA-19/0148, issue 2019-12-13								Hilti technical data			
	M8	M10	M12	M16	M20	M24	M27	M30	M33	M36	M39	
<b>Non-cracked concrete</b>												
Tension $N_{Rk}$	HAS-U 5.8	18,0	29,0	42,0	68,7	109	150	183	218	256	295	336
	HAS-U 8.8	29,0	42,0	56,8	68,7	109	150	183	218	256	295	336
	HAS-U A4	26,0	41,0	56,8	68,7	109	150	183	218	256	295	336
	HAS-U HCR	29,0	42,0	56,8	68,7	109	150	183	218	256	295	336
Shear $V_{Rk}$	HAS-U 5.8	9,0	15,0	21,0	39,0	61,0	88,0	115	140	174	204	244
	HAS-U 8.8	15,0	23,0	34,0	63,0	98,0	141	184	224	278	327	390
	HAS-U A4	13,0	20,0	30,0	55,0	86,0	124	115	140	174	204	244
	HAS-U HCR	15,0	23,0	34,0	63,0	98,0	124	161	196	174	204	244
<b>Cracked concrete</b>												
Tension $N_{Rk}$	HAS-U 5.8	-	19,8	29,0	40,8	64,1	95,0	112	140	156	187	221
	HAS-U 8.8	-	19,8	29,0	40,8	64,1	95,0	112	140	156	187	221
	HAS-U A4	-	19,8	29,0	40,8	64,1	95,0	112	140	156	187	221
	HAS-U HCR	-	19,8	29,0	40,8	64,1	95,0	112	140	156	187	221
Shear $V_{Rk}$	HAS-U 5.8	-	15,0	21,0	39,0	61,0	88,0	115	140	174	204	244
	HAS-U 8.8	-	23,0	34,0	63,0	98,0	141	184	224	278	327	390
	HAS-U A4	-	20,0	30,0	55,0	86,0	124	115	140	174	204	244
	HAS-U HCR	-	23,0	34,0	63,0	98,0	124	161	196	174	204	244

**Design resistance**

Anchor size		ETA-19/0148, issue 2019-12-13								Hilti technical data		
		M8	M10	M12	M16	M20	M24	M27	M30	M33	M36	M39
<b>Non-cracked concrete</b>												
Tension $N_{Rd}$	HAS-U 5.8	12,0	19,3	27,0	32,7	51,9	71,3	87,1	104	122	140	160
	HAS-U 8.8	14,4	20,0	27,0	32,7	51,9	71,3	87,1	104	122	140	160
	HAS-U A4	13,9	20,0	27,0	32,7	51,9	71,3	80,4	98,3	121	140	160
	HAS-U HCR	14,4	20,0	27,0	32,7	51,9	71,3	87,1	104	122	140	160
Shear $V_{Rd}$	HAS-U 5.8	7,2	12,0	16,8	31,2	48,8	70,4	92,0	112	139	163	195
	HAS-U 8.8	12,0	18,4	27,2	50,4	78,4	113	147	179	222	262	312
	HAS-U A4	8,3	12,8	19,2	35,3	55,1	79,5	48,3	58,8	73,1	85,7	103
	HAS-U HCR	12,0	18,4	27,2	50,4	78,4	70,9	92,0	157	87,0	102	122
<b>Cracked concrete</b>												
Tension $N_{Rd}$	HAS-U 5.8	-	9,4	13,8	19,4	30,5	45,2	53,3	66,6	74,1	88,9	105
	HAS-U 8.8	-	9,4	13,8	19,4	30,5	45,2	53,3	66,6	74,1	88,9	105
	HAS-U A4	-	9,4	13,8	19,4	30,5	45,2	53,3	66,6	74,1	88,9	105
	HAS-U HCR	-	9,4	13,8	19,4	30,5	45,2	53,3	66,6	74,1	88,9	105
Shear $V_{Rd}$	HAS-U 5.8	-	12,0	16,8	31,2	48,8	70,4	92,0	112	139	163	195
	HAS-U 8.8	-	18,4	27,2	50,4	78,4	113	147	179	207	249	294
	HAS-U A4	-	12,8	19,2	35,3	55,1	79,5	48,3	58,8	73,1	85,7	103
	HAS-U HCR	-	18,4	27,2	50,4	78,4	70,9	92,0	112	87,0	102	122

**Recommended loads<sup>a)</sup>**

Anchor size		ETA-19/0148, issue 2019-12-13								Hilti technical data		
		M8	M10	M12	M16	M20	M24	M27	M30	M33	M36	M39
<b>Non-cracked concrete</b>												
Tension $N_{rec}$	HAS-U 5.8	8,6	13,8	19,3	23,4	37,1	50,9	62,2	74,2	86,9	100	114
	HAS-U 8.8	10,3	14,3	19,3	23,4	37,1	50,9	62,2	74,2	86,9	100	114
	HAS-U A4	9,9	14,3	19,3	23,4	37,1	50,9	57,4	70,2	86,7	100	114
	HAS-U HCR	10,3	14,3	19,3	23,4	37,1	50,9	62,2	74,2	86,9	100	114
Shear $V_{rec}$	HAS-U 5.8	5,1	8,6	12,0	22,3	34,9	50,3	65,7	80,0	99,4	117	139
	HAS-U 8.8	8,6	13,1	19,4	36,0	56,0	80,6	105	128	159	187	223
	HAS-U A4	6,0	9,2	13,7	25,2	39,4	56,8	34,5	42,0	52,2	61,2	73,2
	HAS-U HCR	8,6	13,1	19,4	36,0	56,0	50,6	65,7	112	62,1	72,9	87,1
<b>Cracked concrete</b>												
Tension $N_{rec}$	HAS-U 5.8	-	6,7	9,9	13,9	21,8	32,3	38,1	47,6	52,9	63,5	75,0
	HAS-U 8.8	-	6,7	9,9	13,9	21,8	32,3	38,1	47,6	52,9	63,5	75,0
	HAS-U A4	-	6,7	9,9	13,9	21,8	32,3	38,1	47,6	52,9	63,5	75,0
	HAS-U HCR	-	6,7	9,9	13,9	21,8	32,3	38,1	47,6	52,9	63,5	75,0
Shear $V_{rec}$	HAS-U 5.8	-	8,6	12,0	22,3	34,9	50,3	65,7	80,0	99,4	117	139
	HAS-U 8.8	-	13,1	19,4	36,0	56,0	80,6	105	128	148	178	210
	HAS-U A4	-	9,2	13,7	25,2	39,4	56,8	34,5	42,0	52,2	61,2	73,2
	HAS-U HCR	-	13,1	19,4	36,0	56,0	50,6	65,7	80,0	62,1	72,9	87,1

a) With overall partial safety factor for action  $\gamma=1,4$ . The partial safety factors for action depend on the type of loading and shall be taken from national regulations.

## Materials

### Mechanical properties

Anchor size			M8	M10	M12	M16	M20	M24	M27	M30
Nominal tensile strength $f_{uk}$	HAS-U 5.8	[N/mm <sup>2</sup> ]	500	500	500	500	500	500	-	-
	HAS-U 8.8	[N/mm <sup>2</sup> ]	800	800	800	800	800	800	800	800
	HAS-U A4	[N/mm <sup>2</sup> ]	700	700	700	700	700	700	500	500
	HAS-U HCR	[N/mm <sup>2</sup> ]	800	800	800	800	800	700	-	-
Yield strength $f_{yk}$	HAS-U 5.8	[N/mm <sup>2</sup> ]	440	440	440	440	400	400	-	-
	HAS-U 8.8	[N/mm <sup>2</sup> ]	640	640	640	640	640	640	640	640
	HAS-U A4	[N/mm <sup>2</sup> ]	450	450	450	450	450	450	210	210
	HAS-U HCR	[N/mm <sup>2</sup> ]	640	640	640	640	640	400	-	-
Stressed cross-section $A_s$	HAS-U	[mm <sup>2</sup> ]	36,6	58,0	84,3	157	245	353	459	561
Moment of resistance W	HAS-U	[mm <sup>3</sup> ]	31,2	62,3	109	277	541	935	1387	1874

### Material quality for HAS-U

Part	Material
<b>Zinc coated steel</b>	
Threaded rod, HAS-U 5.8 (HDG)	Strength class 5.8; Elongation at fracture A5 > 8% ductile Electroplated zinc coated $\geq 5\mu\text{m}$ ; (F) hot dip galvanized $\geq 45\mu\text{m}$
Threaded rod, HAS-U 8.8 (HDG)	Strength class 8.8; Elongation at fracture A5 > 12% ductile Electroplated zinc coated $\geq 5\mu\text{m}$ ; (F) hot dip galvanized $\geq 45\mu\text{m}$
Washer	Electroplated zinc coated $\geq 5\mu\text{m}$ , hot dip galvanized $\geq 45\mu\text{m}$
Nut	Strength class of nut adapted to strength class of threaded rod. Electroplated zinc coated $\geq 5\mu\text{m}$ , hot dip galvanized $\geq 45\mu\text{m}$
<b>Stainless Steel</b> corrosion resistance class III acc. to EN 1993-1-4:2006+A1:2015	
Threaded rod, HAS-U A4	Strength class 70 for $\leq M24$ and strength class 50 for $> M24$ ; Elongation at fracture A5 > 8% ductile
Washer	Stainless steel 1.4401, 1.4404, 1.4578, 1.4571, 1.4439, 1.4362 EN 10088-1:2014
Nut	Stainless steel 1.4401, 1.4404, 1.4578, 1.4571, 1.4439, 1.4362 EN 10088-1:2014
<b>High corrosion resistant steel</b> corrosion resistance class V acc. to EN 1993-1-4:2006+A1:2015	
Threaded rod, HAS-U HCR	Strength class 80 for $\leq M20$ and class 70 for $> M20$ , Elongation at fracture A5 > 8% ductile
Washer	High corrosion resistant steel 1.4529, 1.4565 EN 10088-1:2014
Nut	High corrosion resistant steel 1.4529, 1.4565 EN 10088-1:2014

## Setting information

**Installation temperature range:**  
+5°C to +40°C

### Service temperature range

Hilti HIT-RE 100-HC injection mortar may be applied in the temperature ranges given below. An elevated base material temperature may lead to a reduction of the design bond resistance.

Temperature range	Base material temperature	Max. long term base material temperature	Max. short term base material temperature
Temperature range I	-40 °C to + 40 °C	+ 24 °C	+ 40 °C
Temperature range II	-40 °C to + 58 °C	+ 35 °C	+ 58 °C
Temperature range III	-40 °C to + 70 °C	+ 43 °C	+ 70 °C

### Max. short term base material temperature

Short term elevated base material temperatures are those that occur over brief intervals, e.g. as a result of diurnal cycling.

### Max. long term base material temperature

Long term elevated base material temperatures are roughly constant over significant periods of time.

### Working time and curing time

Temperature of the base material	Max. working time in which rebar can be inserted and adjusted $t_{work}$	Min. curing time before rebar can be fully loaded $t_{cure}$
$5\text{ °C} \leq T_{BM} < 10\text{ °C}$	2,5 h	72 h
$10\text{ °C} \leq T_{BM} < 15\text{ °C}$	2 h	48 h
$15\text{ °C} \leq T_{BM} < 20\text{ °C}$	1 h	24 h
$20\text{ °C} \leq T_{BM} < 30\text{ °C}$	40 min	18 h
$30\text{ °C} \leq T_{BM} \leq 40\text{ °C}$	20 min	6 h

The curing time data are valid for dry base material only. In wet base material the curing times must be doubled.

### Setting details for HAS-U

Anchor size			M8	M10	M12	M16	M20	M24	M27	M30
Nominal diameter of drill bit	$d_0$	[mm]	10	12	14	18	22	28	30	35
Diameter of element	$d$	[mm]	8	10	12	16	20	24	27	30
Effective anchorage and drill hole depth	$h_{ef}$	[mm]	60 to 160	60 to 200	70 to 240	80 to 320	90 to 400	96 to 480	108 to 540	120 to 600
Minimum base material thickness	$h_{min}$	[mm]	$h_{ef} + 30 \geq 100$ mm				$h_{ef} + 2 d_0$			
Diameter of clearance hole in the fixture	$d_f$	[mm]	9	12	14	18	22	26	30	33
Minimum spacing	$s_{min}$	[mm]	40	50	60	75	90	115	120	140
Minimum edge distance	$c_{min}$	[mm]	40	45	45	50	55	60	75	80
Critical spacing for splitting failure	$s_{cr,sp}$	[mm]	$2 c_{cr,sp}$							
Critical edge distance for splitting failure <sup>a)</sup>	$c_{cr,sp}$	[mm]	$1,0 \cdot h_{ef}$ for $h / h_{ef} \geq 2,0$							
			$4,6 h_{ef} - 1,8 h$ for $2,0 > h / h_{ef} > 1,3$							
			$2,26 h_{ef}$ for $h / h_{ef} \leq 1,3$							
Critical spacing for concrete cone failure	$s_{cr,N}$	[mm]	$2 c_{cr,N}$							
Critical edge distance for concrete cone failure <sup>b)</sup>	$c_{cr,N}$	[mm]	$1,5 h_{ef}$							
Torque moment <sup>c)</sup>	$T_{max}$	[Nm]	10	20	40	80	150	200	270	300

For spacing (edge distance) smaller than critical spacing (critical edge distance) the design loads have to be reduced.

- a)  $h_{ef,min} \leq h_{ef} \leq h_{ef,max}$  ( $h_{ef}$ : embedment depth)  $h$ : base material thickness ( $h \geq h_{min}$ )  
b) The critical edge distance for concrete cone failure depends on the embedment depth  $h_{ef}$  and the design bond resistance. The simplified formula given in this table is on the safe side.  
c) This is the maximum recommended torque moment to avoid splitting failure during installation for anchors with minimum spacing and/or edge distance.

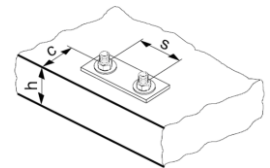
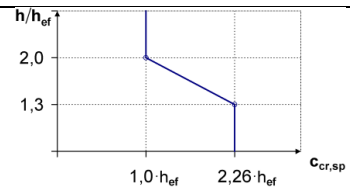

### Installation equipment

Anchor size	M8	M10	M12	M16	M20	M24	M27	M30	
Rotary hammer	TE 2– TE 16				TE 40 – TE 80				
Other tools	Compressed air gun or blow out pump Set of cleaning brushes, dispenser, piston plug								

### Drilling and cleaning parameters

HAS-U	Drill bit diameters $d_0$ [mm]		Installation size [mm]	
	Hammer drill (HD)	Hollow Drill Bit (HDB)	Brush HIT-RB	Piston plug HIT-SZ
<b>M8</b>	10	-	10	-
<b>M10</b>	12	12	12	<b>12</b>
<b>M12</b>	14	14	14	<b>14</b>
<b>M16</b>	18	18	18	<b>18</b>
<b>M20</b>	22	22	22	<b>22</b>
<b>M24</b>	28	28	28	<b>28</b>
<b>M27</b>	30	-	30	<b>30</b>
<b>M30</b>	35	35	35	<b>35</b>

## Setting instructions

\*For detailed information on installation see instruction for use given with the package of the product.



### Safety regulations.

Review the Material Safety Data Sheet (MSDS) before use for proper and safe handling! Wear well-fitting protective goggles and protective gloves when working with Hilti HIT-RE 100-HC.

### Drilling

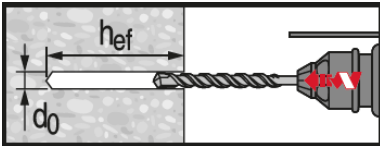

#### Hammer drilled hole

For dry and wet concrete.

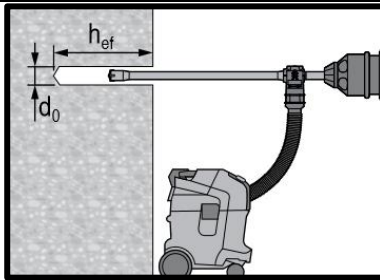

#### Hammer drilled hole with Hollow Drilled Bit (HDB)

No cleaning required.

### Cleaning

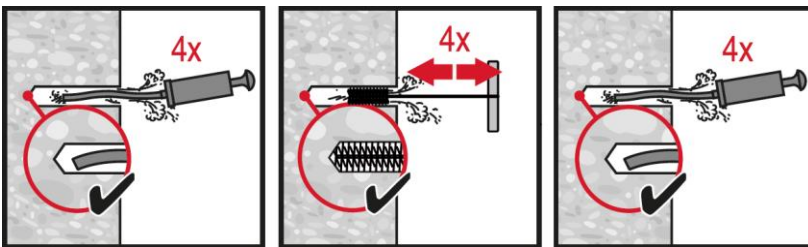

#### Manual cleaning (MC) Non-cracked concrete only

for drill diameters  $d_0 \leq 20$  mm and drill hole depths  $h_0 \leq 10 \cdot d$ .

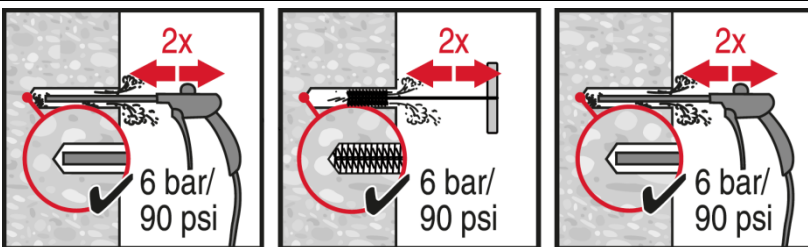

#### Compressed air cleaning (CAC)

for all drill hole diameters  $d_0$  and drill hole depths  $h_0 \leq 20 \cdot d$ .

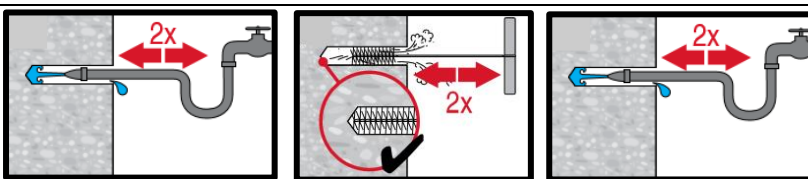

#### Compressed air cleaning (CAC) cleaning of water-filled holes

for all drill hole diameters  $d_0$  and drill hole depths  $h_0$ .

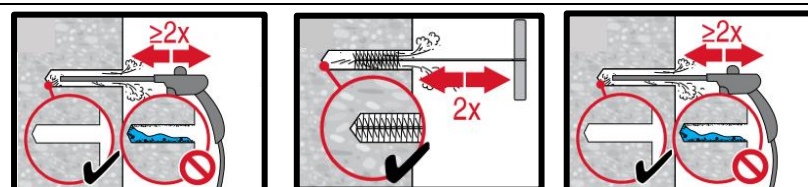

### Injection system

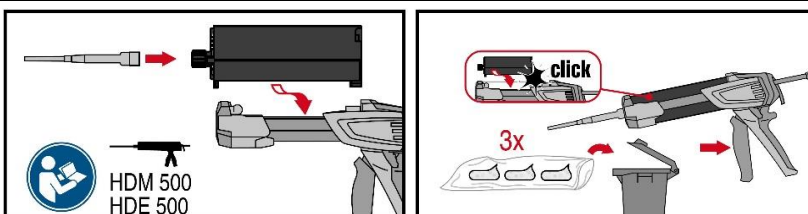

#### Injection system preparation.

HDM 500  
HDE 500



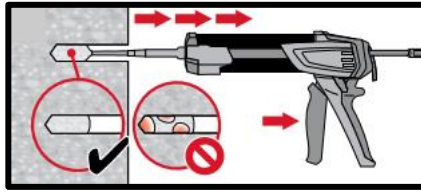
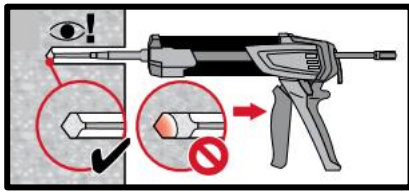

**Injection method for drill hole depth**  
 $h_{ef} \leq 250$  mm.

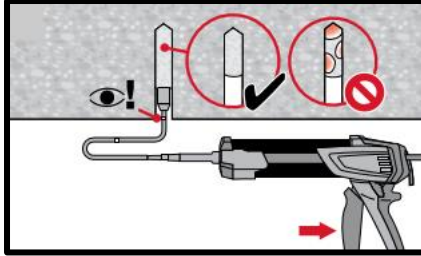
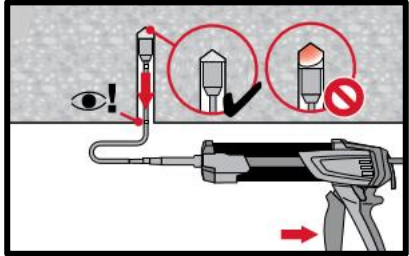

**Injection method for overhead application and/or installation with embedment depth**  
 $h_{ef} > 250$  mm.

**Setting the element**

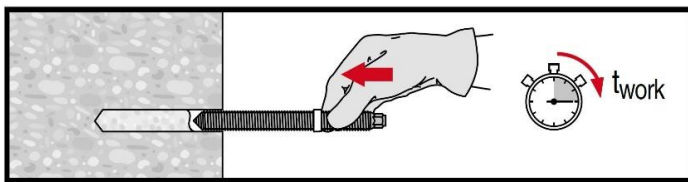

**Setting element**, observe working time " $t_{work}$ ",

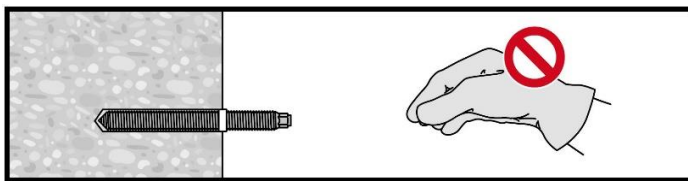

**Setting element for overhead applications**, observe working time " $t_{work}$ ",

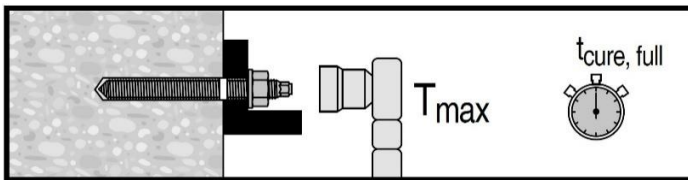

**Loading the anchor:** After required curing time  $t_{cure}$  the anchor can be loaded.





# HIT-RE 100-HC injection mortar

Anchor design (EN 1992-4) / Rebar elements / Concrete



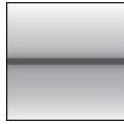
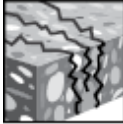
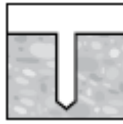

Concrete  
Chemical anchors

Injection mortar system	Benefits
 Hilti HIT-RE 100-HC 580 ml hard cartridge	<ul style="list-style-type: none"> <li>- Suitable for cracked and uncracked concrete C 20/25 to C 50/60</li> <li>- High loading capacity</li> <li>- Suitable for dry and water saturated concrete</li> <li>- Large diameter applications</li> <li>- Long working time at elevated temperatures</li> <li>- Odourless epoxy</li> </ul>
 Rebar B500B (φ8-φ32)	

Mechanical anchors

Base material	Load conditions
 Concrete (uncracked)	 Static/ quasi-static
 Concrete (cracked)	
 Dry concrete	
 Wet concrete	

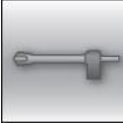
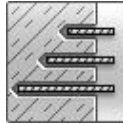
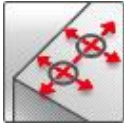
Plastic/Light duty metal anchors

Installation conditions	Other informations
 Hammer drilling	 European Technical Assessment
 Hollow drill-bit drilling	
 Variable embedment depth	
 Small edge distance and spacing	
 CE conformity	

### Approvals / certificates

Description	Authority / Laboratory	No. / date of issue
European technical assessment <sup>a)</sup>	DIBt, Berlin	ETA-19/0148 / 2019-12-13

<sup>a)</sup> All data given in this section according to ETA-19/0148, issue 2019-12-13.

Insulation anchors

## Static and quasi-static loading (for a single anchor)

### All data in this section applies to

- Correct setting (See setting instruction)
- No edge distance and spacing influence
- Steel* failure
- Base material thickness, as specified in the table
- One typical embedment depth, as specified in the table
- One anchor material, as specified in the tables
- Concrete C 20/25,  $f_{ck,cube} = 25 \text{ N/mm}^2$
- Temperate range I  
(min. base material temperature  $-40^\circ\text{C}$ , max. long term/short term base material temperature:  $+24^\circ\text{C}/40^\circ\text{C}$ )

### Embedment depth and base material thickness for static and quasi-static loading data

Anchor- size	ETA-19/0148, issue 2019-12-13											Hilti technical data	
	$\phi 8$	$\phi 10$	$\phi 12$	$\phi 14$	$\phi 16$	$\phi 20$	$\phi 25$	$\phi 26$	$\phi 28$	$\phi 30$	$\phi 32$	$\phi 36$	$\phi 40$
Typical embedment [mm]	80	90	110	125	125	170	210	240	270	270	300	330	360
Base material thickness [mm]	110	120	140	160	170	220	280	310	340	350	380	420	470

### Characteristic resistance

Anchor- size B500 B	ETA-19/0148, issue 2019-12-13											Hilti technical data	
	$\phi 8$	$\phi 10$	$\phi 12$	$\phi 14$	$\phi 16$	$\phi 20$	$\phi 25$	$\phi 26$	$\phi 28$	$\phi 30$	$\phi 32$	$\phi 36$	$\phi 40$
<b>Non-cracked concrete</b>													
Tensile $N_{Rk}$ [kN]	24,1	33,9	49,8	60,5	68,7	109	150	183	218	218	256	295	336
Shear $V_{Rk}$ [kN]	14,0	22,0	31,0	42,0	55,0	86,0	135	146	169	194	221	280	346
<b>Cracked concrete</b>													
Tensile $N_{Rk}$ [kN]	-	12,7	18,7	22,0	25,1	37,4	57,7	58,8	71,3	76,3	90,5	112	136
Shear $V_{Rk}$ [kN]	-	22,0	31,0	42,0	50,3	74,8	116	118	143	153	181	224	271

### Design resistance

Anchor- size B500 B	ETA-19/0148, issue 2019-12-13											Hilti technical data	
	$\phi 8$	$\phi 10$	$\phi 12$	$\phi 14$	$\phi 16$	$\phi 20$	$\phi 25$	$\phi 26$	$\phi 28$	$\phi 30$	$\phi 32$	$\phi 36$	$\phi 40$
<b>Non-cracked concrete</b>													
Tensile $N_{Rd}$ [kN]	11,5	16,2	23,7	28,8	32,7	51,9	71,3	87,1	104	104	122	140	160
Shear $V_{Rd}$ [kN]	9,3	14,7	20,7	28,0	36,7	57,3	90,0	97,3	113	129	147	187	231
<b>Cracked concrete</b>													
Tensile $N_{Rd}$ [kN]	-	6,1	8,9	10,5	12,0	17,8	27,5	28,0	33,9	36,4	43,1	53,3	64,6
Shear $V_{Rd}$ [kN]	-	14,7	20,7	28,0	33,5	49,8	77,0	78,4	95,0	102	121	149	181

### Recommended loads <sup>a)</sup>

Anchor-size B500 B	ETA-19/0148, issue 2019-12-13											Hilti technical data	
	φ8	φ10	φ12	φ14	φ16	φ20	φ25	φ26	φ28	φ30	φ32	φ36	φ40
<b>Non-cracked concrete</b>													
Tensile N <sub>rec</sub> [kN]	8,2	11,5	16,9	20,6	23,4	37,1	50,9	62,2	74,2	74,2	86,9	100	114
Shear V <sub>rec</sub> [kN]	6,7	10,5	14,8	20,0	26,2	41,0	64,3	69,5	80,5	92,4	105	133	165
<b>Cracked concrete</b>													
Tensile N <sub>rec</sub> [kN]	-	4,3	6,3	7,5	8,5	12,7	19,6	20,0	24,2	26,0	30,8	38,1	46,2
Shear V <sub>rec</sub> [kN]	-	10,5	14,8	20,0	23,9	35,6	55,0	56,0	67,9	72,7	86,2	107	129

a) With overall partial safety factor for action  $\gamma=1,4$ . The partial safety factors for action depend on the type of loading and shall be taken from national regulations.

### Materials

#### Mechanical properties

Anchor size	φ8	φ10	φ12	φ14	φ16	φ20	φ25	φ26	φ28	φ30	φ32
Nominal tensile strength f <sub>uk</sub> [N/mm <sup>2</sup> ]	550	550	550	550	550	550	550	550	550	550	550
Yield strength f <sub>yk</sub> [N/mm <sup>2</sup> ]	500	500	500	500	500	500	500	500	500	500	500
Stressed cross-section A <sub>s</sub> [mm <sup>2</sup> ]	50,3	78,5	113,1	153,9	201,1	314,2	490,9	531	615,8	707	804,2
Moment of resistance W [mm <sup>3</sup> ]	50,3	98,2	169,6	269,4	402,1	785,4	1534	1726	2155	2651	3217

#### Material quality

Part	Material
Rebar EN 1992-1-1:2004	Bars and de-coiled rods class B or C With f <sub>yk</sub> and k according to NDP or NCL of EN 1992-1-1/NA f <sub>uk</sub> = f <sub>tk</sub> = k · f <sub>yk</sub>

### Setting information

#### Installation temperature

+ 5°C to + 40°C

#### Service temperature range

Hilti HIT-RE 100-HC injection mortar may be applied in the temperature ranges given below, An elevated base material temperature may lead to a reduction of the design bond resistance,

Temperature range	Base material temperature	Max, long term base material temperature	Max, short term base material temperature
Temperature range I	-40 °C to + 40 °C	+ 24 °C	+ 40 °C
Temperature range II	-40 °C to + 58 °C	+ 35 °C	+ 58 °C
Temperature range III	-40 °C to + 70 °C	+ 43 °C	+ 70 °C

#### Max, short term base material temperature

Short term elevated base material temperatures are those that occur over brief intervals, e.g, as a result of diurnal cycling,

#### Max, long term base material temperature

Long term elevated base material temperatures are roughly constant over significant periods of time,

### Working time and curing time

Temperature of the base material	Max, working time in which rebar can be inserted and adjusted $t_{work}$	Min, curing time before rebar can be fully loaded $t_{cure}$
$5\text{ °C} \leq T_{BM} < 10\text{ °C}$	2,5 h	72 h
$10\text{ °C} \leq T_{BM} < 15\text{ °C}$	2 h	48 h
$15\text{ °C} \leq T_{BM} < 20\text{ °C}$	1 h	24 h
$20\text{ °C} \leq T_{BM} < 30\text{ °C}$	40 min	18 h
$30\text{ °C} \leq T_{BM} \leq 40\text{ °C}$	20 min	6 h

The curing time data are valid for dry base material only. In wet base material the curing times must be doubled.

### Setting details

Anchor size		Ø8	Ø10	Ø12		Ø14	Ø16	Ø20	Ø25	Ø26	Ø28	Ø30	Ø32
Nominal diameter of drill bit	$d_0$ [mm]	10 / 12 <sup>a)</sup>	12 / 14 <sup>a)</sup>	14 <sup>a)</sup>	16 <sup>a)</sup>	18	20	25 / 24 <sup>a)</sup>	32 / 30 <sup>a)</sup>	32	35	37	40
Effective anchorage and drill hole depth range <sup>b)</sup>	$h_{ef,min}$ [mm]	60	60	70	70	75	80	90	100	104	112	120	128
	$h_{ef,max}$ [mm]	160	200	240	240	280	320	400	500	520	560	600	640
Minimum base material thickness	$h_{min}$ [mm]	$h_{ef} + 30\text{ mm} \geq 100\text{ mm}$				$h_{ef} + 2\text{ }d_0$							
Minimum spacing	$s_{min}$ [mm]	40	50	60	60	70	80	100	125	130	140	150	160
Minimum edge distance	$c_{min}$ [mm]	40	45	45	45	50	50	65	70	75	75	80	80
Critical spacing for splitting failure	$s_{cr,sp}$ [mm]	$2\text{ }C_{cr,sp}$											
Critical edge distance for splitting failure <sup>c)</sup>	$c_{cr,sp}$ [mm]	$1,0 \cdot h_{ef}$				for $h / h_{ef} \geq 2,0$							
		$4,6\text{ }h_{ef} - 1,8\text{ }h$				for $2,0 > h / h_{ef} > 1,3$							
		$2,26\text{ }h_{ef}$				for $h / h_{ef} \leq 1,3$							
Critical spacing for concrete cone failure	$s_{cr,N}$ [mm]	$2\text{ }C_{cr,N}$											
Critical edge distance for concrete cone failure <sup>d)</sup>	$c_{cr,N}$ [mm]	$1,5\text{ }h_{ef}$											

For spacing (edge distance) smaller than critical spacing (critical edge distance) the design loads have to be reduced.

a) Both given values for drill bit diameter can be used

b)  $h_{ef,min} \leq h_{ef} \leq h_{ef,max}$  ( $h_{ef}$ : embedment depth)

c)  $h$ : base material thickness ( $h \geq h_{min}$ )



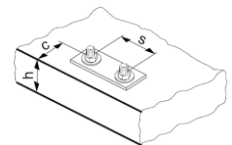
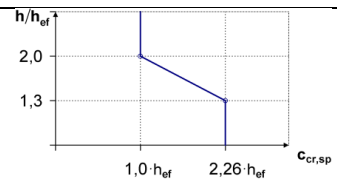

d) The critical edge distance for concrete cone failure depends on the embedment depth  $h_{ef}$  and the design bond resistance. The simplified formula given in this table is on the save side,



### Installation equipment

Anchor size	φ8	φ10	φ12	φ14	φ16	φ20	φ25	φ26	φ28	φ30	φ32
Rotary hammer	TE 2– TE 16					TE 40 – TE 80					
Other tools	Compressed air gun or blow out pump Set of cleaning brushes, dispenser, piston plug										

### Drilling and cleaning parameters

Rebar [mm]	Drill bit diameters d <sub>0</sub> [mm]		Installation size [mm]	
	Hammer drill (HD)	Hollow Drill Bit (HDB)	Brush HIT-RB	Piston plug HIT-SZ
				
φ8	10 / 12 <sup>a)</sup>	12	10 / 12 <sup>a)</sup>	12
φ10	12 / 14 <sup>a)</sup>	12 / 14 <sup>a)</sup>	12 / 14 <sup>a)</sup>	12 / 14 <sup>a)</sup>
φ12	14 / 16 <sup>a)</sup>	14 / 16 <sup>a)</sup>	14 / 16 <sup>a)</sup>	14 / 16 <sup>a)</sup>
φ14	18	18	18	18
φ16	20	20	20	20
φ20	24 / 25 <sup>a)</sup>	24 / 25 <sup>a)</sup>	24 / 25 <sup>a)</sup>	24 / 25 <sup>a)</sup>
φ25	30 / 32 <sup>a)</sup>	32	30 / 32 <sup>a)</sup>	30 / 32 <sup>a)</sup>
φ26	32	32	32	32
φ28	35	35	35	35
φ30	37	-	37	37
φ32	40	-	40	40

a) Both of the two given values can be used

## Setting instructions

\*For detailed information on installation see instruction for use given with the package of the product,



### Safety regulations,

Review the Material Safety Data Sheet (MSDS) before use for proper and safe handling! Wear well-fitting protective goggles and protective gloves when working with Hilti HIT-RE 100-HC.

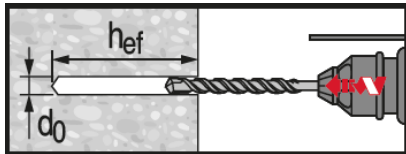

### Hammer drilled hole

For dry and wet concrete,

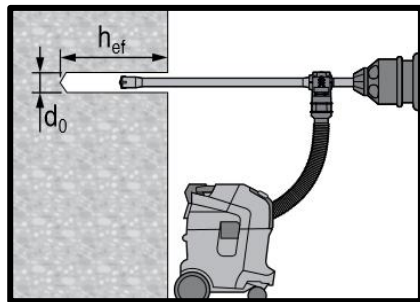

### Hammer drilled hole with Hollow Drilled Bit (HDB)

No cleaning required,

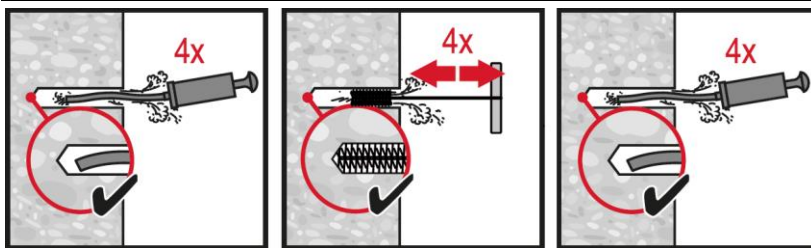

### Manual cleaning (MC) Non-cracked concrete only

for drill diameters  $d_0 \leq 20$  mm and drill hole depth  $h_0 \leq 10 \cdot d$ ,

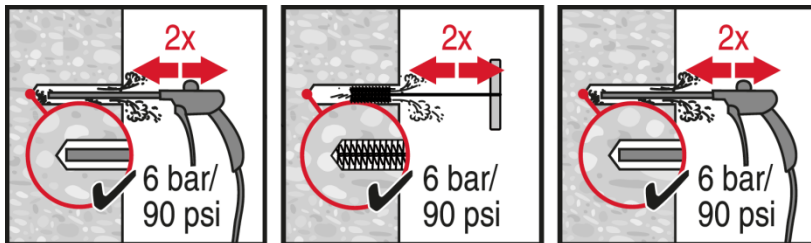

### Hammer Drilling:

### Compressed air cleaning (CAC)

for all drill hole diameters  $d_0$  and drill hole depths  $h_0 \leq 20 \cdot d$ ,

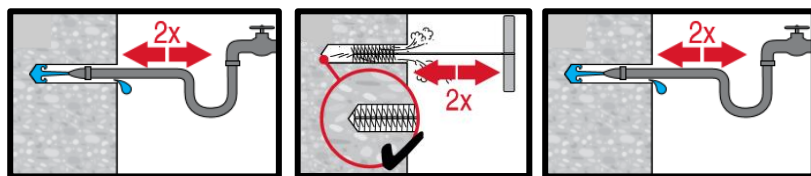

### Compressed air cleaning (CAC) cleaning of water-filled holes

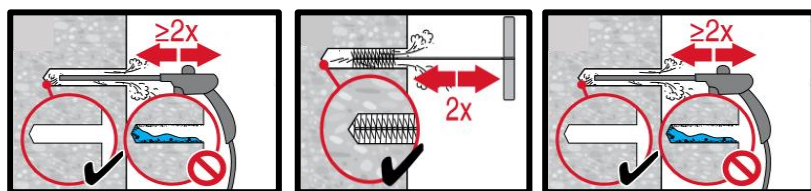

for all drill hole diameters  $d_0$  and drill hole depths  $h_0$ ,

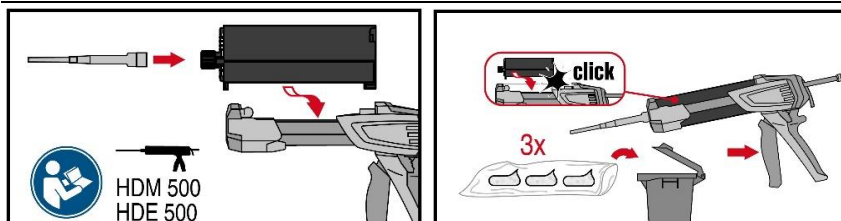

### Injection system preparation,

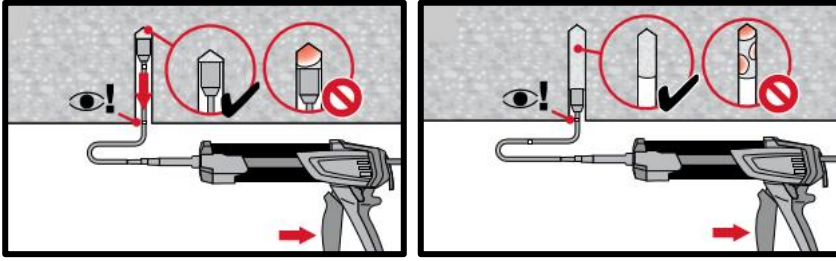

**Injection** method for overhead application and/or installation with embedment depth  $h_{ef} \leq 250$  mm

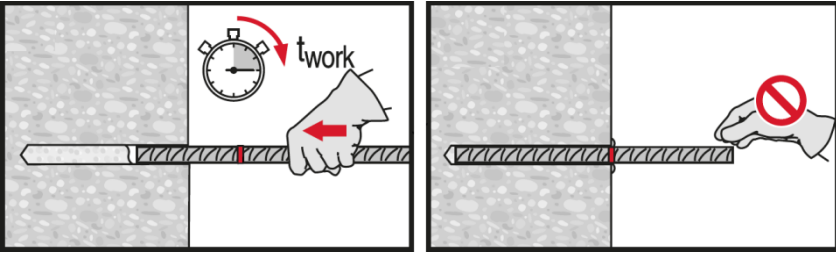

**Setting element**, observe working time "t<sub>work</sub>",

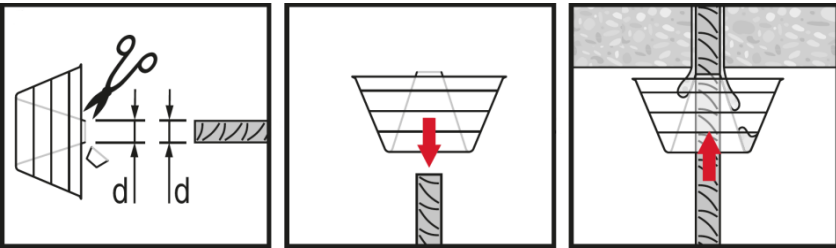

**Setting element** for overhead applications, observe working time "t<sub>work</sub>",

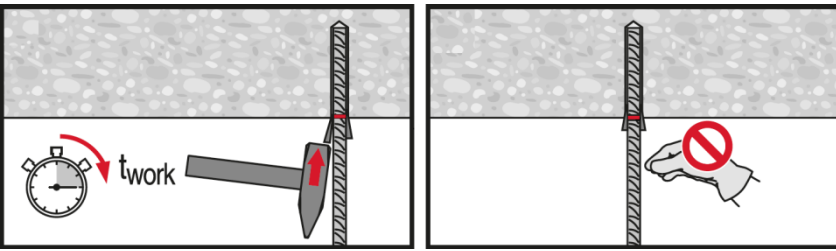





Concrete

Chemical anchors

Mechanical anchors

Plastic/Light duty metal anchors

Insulation anchors

# HIT-RE 100-HC injection mortar

Rebar design (EOTA TR023) / Rebar elements / Concrete

Concrete

Chemical anchors

Mechanical anchors

Plastic/Light duty metal anchors

Insulation anchors

## Injection mortar system



Hilti HIT-RE 100-HC  
580 ml hard cartridge



Rebar B500 B  
(φ8 - φ40)

## Benefits

- Suitable for concrete C 12/15 to C 50/60
- High loading capacity
- Suitable for dry and water saturated concrete
- For rebar diameters up to 40 mm
- Non corrosive to rebar elements
- Long working time at elevated temperatures
- Suitable for embedment length till 3200 mm

## Base material



Concrete (uncracked)



Concrete (cracked)

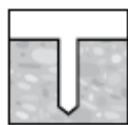

Dry concrete



Wet concrete

## Load conditions



Static/  
quasi-static



Fire  
resistance

## Installation conditions

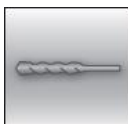

Hammer  
drilling

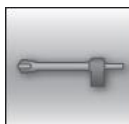

Hollow drill-  
bit drilling



Diamond  
coring

## Other information



European  
Technical  
Assessment



CE  
conformity

## Approvals / certificates

Description	Authority / Laboratory	No. / date of issue
European technical assessment <sup>a)</sup>	DIBt, Berlin	ETA-19/0149 / 2019-12-10

a) All data given in this section according to ETA-19/0149, issue 2019-12-10.

## Basic design data

### Static EC2 design

Design bond strength in N/mm<sup>2</sup> according to ETA-19/0149 for good bond conditions

Rebar-size	Concrete class								
	C12/15	C16/20	C20/25	C25/30	C30/37	C35/45	C40/50	C45/55	C50/60
<b>All allowed hammer drilling methods</b>									
φ8 - φ32	1,6	2,0	2,3	2,7	3,0	3,4	3,7	4,0	4,3
φ34	1,6	2,0	2,3	2,6	2,9	3,3	3,6	3,9	4,2
φ36	1,5	1,9	2,2	2,6	2,9	3,3	3,6	3,8	4,1
φ40	1,5	1,8	2,1	2,5	2,8	3,1	3,4	3,7	4,0
<b>Diamond coring wet</b>									
φ8 - φ32	1,6	2,0	2,3	2,7					
φ34	1,6	2,0	2,3	2,6					
φ36	1,5	1,9	2,2	2,6					
φ40	1,5	1,8	2,1	2,5					

For poor bond conditions multiply the values by 0,7, Values valid for non-cracked and cracked concrete

### Minimum anchorage length and minimum lap length

The minimum anchorage length  $\ell_{b,min}$  and the minimum overlap length  $\ell_{0,min}$  according to EN 1992-1-1 shall be multiplied by the relevant **Amplification factor** in the table below,

**Amplification factor  $\alpha_{lb}$  for the min, anchorage length and min, lap length according to EN 1992-1-1 for:**

Rebar - size	Concrete class								
	C12/15	C16/20	C20/25	C25/30	C30/37	C35/45	C40/50	C45/55	C50/60
<b>All allowed hammer drilling methods</b>									
φ8 -φ40	1,0								
<b>Diamond coring dry and wet</b>									
φ8 -φ40	1,5								

### Pre-calculated values<sup>1)</sup> – anchorage length

Rebar yield strength  $f_{yk}=500$  N/mm<sup>2</sup>, concrete C25/30, good bond conditions

Rebar-size	Anchorage length	Design value	Mortar volume <sup>2)</sup>	Anchorage length	Design value	Mortar volume <sup>2)</sup>
	$\ell_{bd}$ [mm]	$N_{Rd}$ [KN]	$V_M$ [ml]		$\ell_{bd}$ [mm]	$N_{Rd}$ [KN]
$\alpha_1=\alpha_2=\alpha_3=\alpha_4=\alpha_5=1,0$						
φ8	100	6,8	8	100	9,7	8
	170	11,5	13	140	13,6	11
	250	17,0	19	180	17,4	14
	<b>322,1</b>	21,9	24	<b>225,4</b>	21,9	17
φ10	121	10,3	11	121	14,7	11
	220	18,7	20	170	20,6	15
	310	26,3	28	230	27,9	21
	<b>402,6</b>	34,1	36	<b>281,8</b>	34,1	25
φ12	145	14,8	15	145	21,1	15
	260	26,5	27	210	30,5	22
	370	37,7	39	270	39,3	29
	<b>483,1</b>	49,2	51	<b>338,2</b>	49,2	36
φ14	169	20,1	20	169	28,7	20
	300	35,6	36	240	40,7	29
	430	51,1	52	320	54,3	39
	<b>563,6</b>	66,9	68	<b>394,5</b>	66,9	48

### Pre-calculated values<sup>1)</sup> – anchorage length

Rebar yield strength  $f_{yk}=500$  N/mm<sup>2</sup>, concrete C25/30, good bond conditions

Rebar-size	Anchorage length	Design value	Mortar volume <sup>2)</sup>	Anchorage length	Design value	Mortar volume <sup>2)</sup>
	$l_{bd}$ [mm]	$N_{Rd}$ [KN]	$V_M$ [ml]		$l_{bd}$ [mm]	$N_{Rd}$ [KN]
	$\alpha_1=\alpha_2=\alpha_3=\alpha_4=\alpha_5=1,0$			$\alpha_1=\alpha_3=\alpha_4=1,0 \quad \alpha_2 \text{ or } \alpha_5=0,7$		
φ16	193	26,2	26	193	37,4	26
	340	46,1	46	280	54,3	38
	490	66,5	67	370	71,7	50
	<b>644</b>	87,4	87	<b>450,9</b>	87,4	61
φ18	217	33,1	33	217	47,3	33
	380	58	57	310	67,6	47
	540	82,4	81	410	89,4	62
	<b>724,6</b>	110,6	109	<b>507,2</b>	110,6	76
φ20	242	41,1	51	242	58,6	51
	390	66,2	83	350	84,8	74
	550	93,3	117	460	111,5	98
	<b>805,2</b>	136,6	171	<b>563,6</b>	136,6	120
φ22	266	49,6	75	266	70,9	75
	410	76,5	116	380	101,3	107
	560	104,5	158	500	133,3	141
	<b>885,7</b>	165,3	250	<b>620</b>	165,3	175
φ24	290	59	122	290	84,3	122
	430	87,5	182	420	122,1	177
	560	114	236	550	160	232
	<b>966,2</b>	196,7	408	<b>676,3</b>	196,7	286
φ25	302	64	114	302	91,5	114
	430	91,2	162	430	130,3	162
	570	120,9	214	570	172,7	214
	<b>1006,4</b>	213,4	378	<b>704,5</b>	213,4	265
φ28	350	83,1	145	338	114,7	140
	595	141,3	247	480	162,9	200
	875	207,8	364	635	215,5	264
	<b>1127,2</b>	267,7	469	<b>789</b>	267,7	328
φ30	374	95,2	165	374	136	165
	635	161,6	281	528	191,9	233
	935	237,9	413	700	254,5	309
	<b>1207,7</b>	307,3	534	<b>845,4</b>	307,3	374
φ32	400	108,6	217	400	155,1	217
	680	184,6	369	580	224,9	315
	1000	271,4	543	800	310,2	434
	<b>1288,2</b>	349,7	699	<b>901,8</b>	349,7	490
φ36	450	132,3	387	440	184,8	379
	765	225	658	640	268,8	551
	1125	330,8	968	900	378,1	774
	<b>1505,0</b>	442,6	1295	<b>1053,5</b>	442,6	907
φ40	500	157,1	520	485	217,7	505
	850	267	884	700	314,2	728
	1000	314,2	1040	990	444,3	1030
	<b>1739,1</b>	546,4	1810	<b>1217,4</b>	546,4	1267

1) Values corresponding to the minimum anchorage length. The maximum permissible load is valid for "good bond conditions" as described in EN 1992-1-1. For all other conditions multiply by the value by 0,7,

2) The volume of mortar corresponds to the formula " $1,2 \cdot (d_o^2 - d_s^2) \cdot \pi \cdot l_b / 4$ " for hammer drilling

**Pre-calculated values – overlap length**

Rebar yield strength  $f_{yk}=500 \text{ N/mm}^2$ , concrete c25/30, good bond conditions

Rebar-size	Overlap length	Design value	Mortar volume <sup>2)</sup>	Overlap length	Design value	Mortar volume <sup>2)</sup>
	$l_0$ [mm]	$N_{Rd}$ [KN]	$V_M$ [ml]		$l_0$ [mm]	$N_{Rd}$ [KN]
$\alpha_1=\alpha_2=\alpha_3=\alpha_4=\alpha_5=1,0$				$\alpha_1=\alpha_3=\alpha_4=1,0 \quad \alpha_2 \text{ or } \alpha_5=0,7$		
φ8	200	13,6	15	200	19,4	15
	240	16,3	18	210	20,4	16
	280	19	21	220	21,3	17
	<b>322,1</b>	21,9	24	<b>225,4</b>	21,9	17
φ10	200	17	18	200	24,2	18
	270	22,9	24	230	27,9	21
	340	28,8	31	250	30,3	23
	<b>402,6</b>	34,1	36	<b>281,8</b>	34,1	25
φ12	200	20,4	21	200	29,1	21
	290	29,5	31	250	36,4	26
	390	39,7	41	290	42,2	31
	<b>483,1</b>	49,2	51	<b>338,2</b>	49,2	36
φ14	210	24,9	25	210	35,6	25
	330	39,2	40	270	45,8	33
	450	53,4	54	330	56	40
	<b>563,6</b>	66,9	68	<b>394,5</b>	66,9	48
φ16	240	32,6	33	240	46,5	33
	370	50,2	50	310	60,1	42
	510	69,2	69	380	73,7	52
	<b>644</b>	87,4	87	<b>450,9</b>	87,4	61
φ18	270	41,2	41	270	58,9	41
	410	62,6	62	350	76,3	53
	560	85,5	84	430	93,8	65
	<b>724,6</b>	110,6	109	<b>507,2</b>	110,6	76
φ20	300	50,9	64	300	72,7	64
	430	72,9	91	390	94,5	83
	570	96,7	121	480	116,3	102
	<b>805,2</b>	136,6	171	<b>563,6</b>	136,6	120
φ22	330	61,6	93	330	88	93
	450	84	127	430	114,6	122
	580	108,2	164	520	138,6	147
	<b>885,7</b>	165,3	250	<b>620</b>	165,3	175
φ24	360	73,3	152	360	104,7	152
	470	95,7	198	470	136,7	198
	590	120,1	249	570	165,8	241
	<b>966,2</b>	196,7	408	<b>676,3</b>	196,7	286
φ25	375	79,5	141	375	113,6	141
	430	91,2	162	480	145,4	181
	570	120,9	214	590	178,7	222
	<b>1006,4</b>	213,4	378	<b>704,5</b>	213,4	265
φ28	420	99,8	175	420	142,5	175
	595	141,3	247	530	179,8	220
	875	207,8	364	635	215,5	264
	<b>1127,2</b>	267,7	469	<b>789</b>	267,7	328

Concrete

Chemical anchors

Mechanical anchors

Plastic/Light duty metal anchors

Insulation anchors

## Pre-calculated values – overlap length

Rebar yield strength  $f_{yk}=500 \text{ N/mm}^2$ , concrete c25/30, good bond conditions

Rebar-size	Overlap length	Design value	Mortar volume <sup>2)</sup>	Overlap length	Design value	Mortar volume <sup>2)</sup>
	$l_0$ [mm]	$N_{Rd}$ [KN]	$V_M$ [ml]		$l_0$ [mm]	$N_{Rd}$ [KN]
	$\alpha_1=\alpha_2=\alpha_3=\alpha_4=\alpha_5=1,0$			$\alpha_1=\alpha_3=\alpha_4=1,0 \quad \alpha_2 \text{ or } \alpha_5=0,7$		
$\phi 30$	450	114,5	199	450	163,6	199
	635	161,6	281	528	191,9	233
	935	237,9	413	700	254,5	309
	<b>1207,7</b>	<b>307,3</b>	<b>534</b>	<b>845,4</b>	<b>307,3</b>	<b>374</b>
$\phi 32$	480	130,3	261	480	186,1	261
	680	184,6	369	650	252	353
	1000	271,4	543	800	310,2	434
	<b>1288,2</b>	<b>349,7</b>	<b>699</b>	<b>901,8</b>	<b>349,7</b>	<b>490</b>
$\phi 36$	540	158,8	465	540	218,1	465
	765	225,0	658	720	290,0	620
	1125	330,8	968	900	363,5	774
	<b>1505,0</b>	<b>442,6</b>	<b>1295</b>	<b>1053,5</b>	<b>442,6</b>	<b>907</b>
$\phi 40$	600	188,5	624	600	269,3	624
	850	267,0	884	750	336,6	780
	1000	314,2	1040	990	444,3	1030
	<b>1739,1</b>	<b>505,9</b>	<b>1676</b>	<b>1217,4</b>	<b>546,4</b>	<b>1267</b>

- 1) Values corresponding to the minimum anchorage length. The maximum permissible load is valid for "good bond conditions" as described in EN 1992-1-1. For all other conditions multiply by the value by 0,7.
- 2) The volume of mortar corresponds to the formula " $1,2 \cdot (d_o^2 - d_s^2) \cdot \pi \cdot l_b / 4$ " for hammer drilling

## Fire resistance

The design method consists of four steps. First, determining a reduction factor  $KN(\theta)$ , which describes the proportion between bond resistance and temperature, based on pullout tests at various temperatures. Secondly, a thermal simulation using the Finite Elements method is carried out to determine the temperature figure along the rebar at certain time  $T$  during a fire. Thirdly, the bond resistances in case of fire are estimated using the first two steps. A fourth step, in case of the beam-wall connection, is the calculation of the characteristic maximal load by integration of the bond resistance. Thermal simulations, geometrics considerations and safety co-efficients are determined in accordance with Eurocode and standards.

### Step 1

Reduction factor  $KN(\theta)$

### Step 2

Finite Element simulation: Temperature profile for each rebar diameter and anchorage length along the bonding interface in relation to the fire exposure duration  $T$ .

### Step 3

Slab-slab connection:  $TR_k$  along the bonding interface

### Step 4

Characteristic maximal load

$$F_{bk} = \emptyset \cdot \pi \cdot \int_0^L \tau_{Rk} \cdot (T(x)) \cdot dx$$

Where:

- $\tau_{Rk}$ : the characteristic bonding resistance [N/mm<sup>2</sup>].
- $T$ : the temperature [°].
- $F_{bk}$ : the characteristic maximum load applicable to the rebar at a given time [N].
- $L$ : the embedment length [mm].
- $\emptyset$ : the rebar diameter [mm].

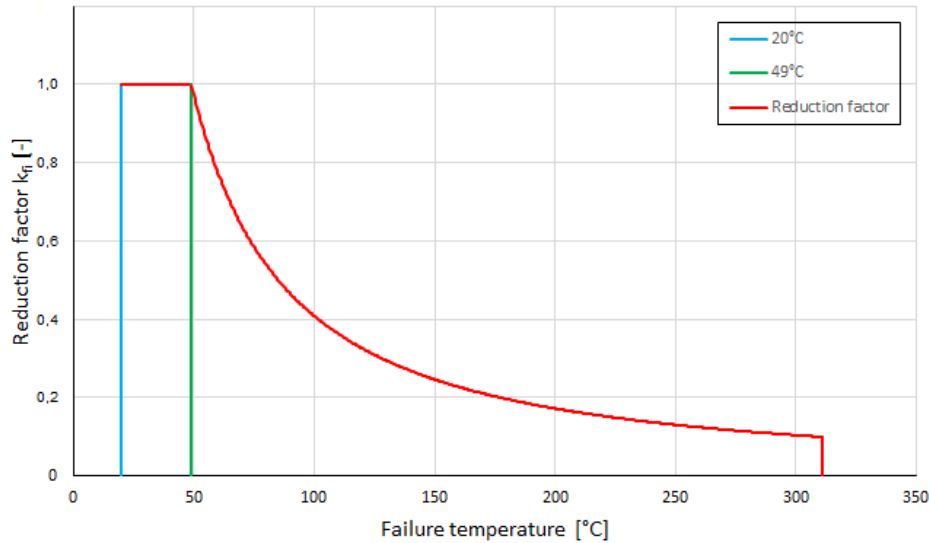

Relationship between temperature and the reduction factor

$$\begin{aligned}
 20^{\circ}\text{C} \leq \theta \leq 49^{\circ}\text{C} & \quad k_N = 1 \\
 50^{\circ}\text{C} \leq \theta \leq 311^{\circ}\text{C} & \quad k_N = \frac{1285,7 * \theta^{-1,249}}{10} \\
 \theta > 311^{\circ}\text{C} & \quad k_N = 0
 \end{aligned}$$

This report uses the characteristic values of bond strength. Accordingly, the values of bond resistance and load resistance in case of fire are given as characteristic values

**a) Anchoring application**

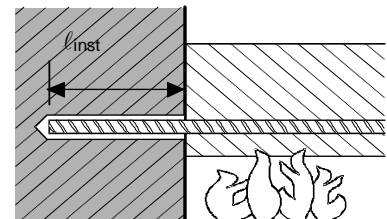

**Anchoring application beam-wall connections with a concrete cover of 20 mm**

**Maximum force ( $F_{s,T,max}$ ) in rebar in conjunction with HIT-RE 100-HC as a function of embedment depth ( $l_{inst}$ ) for the fire resistance classes F30 to F240 according to EC2.**

Rebar-size	$F_{s,T,max}$ [kN]	$l_{inst}$ [mm]	Fire resistance of bar [kN]					
			R30	R60	R90	R120	R180	R240
$\phi 8$	16,8	100	3,9	1,6	0,9	0,6	0,3	0,1
		110	4,6	1,9	1,1	0,7	0,4	0,1
		140	7,4	4,3	2,6	1,7	1,0	0,6
		160	9,1	6,1	4,0	2,7	1,6	1,0
		260	17,8	14,8	12,6	10,9	8,0	5,6
		290	20,4	17,4	15,2	13,5	10,6	8,0
		310	22,1	19,1	16,9	15,2	12,4	9,9
		330	23,8	20,8	18,7	16,9	14,1	11,6
		370	25,1	24,3	22,1	20,4	17,6	15,1
		400		25,1	24,7	23,0	20,2	17,7
$\phi 10$	26,2	110	5,6	2,3	1,3	0,8	0,5	0,1
		140	9,1	5,1	3,0	2,1	1,3	0,8
		160	11,3	7,3	4,6	3,2	1,9	1,2
		260	22,1	18,1	15,4	13,2	9,7	6,7
		290	25,4	21,4	18,6	16,4	13,0	9,6
		310	27,6	23,6	20,8	18,6	15,1	12,0
		340	30,8	26,8	24,0	21,9	18,4	15,2
		360	33,0	29,0	26,2	24,0	20,5	17,4
		380	35,1	31,1	28,4	26,2	22,7	19,6
		450	39,3	38,7	35,9	33,8	30,3	27,1



Maximum force ( $F_{s,T,max}$ ) in rebar in conjunction with HIT-RE 100-HC as a function of embedment depth ( $l_{inst}$ ) for the fire resistance classes F30 to F240 according to EC2.

Rebar-size	$F_{s,T,max}$ [kN]	$l_{inst}$ [mm]	Fire resistance of bar [kN]					
			R30	R60	R90	R120	R180	R240
$\phi 12$	37,7	110	6,5	2,6	1,5	0,9	0,6	0,1
		140	10,7	5,8	3,4	2,4	1,4	0,9
		160	13,3	8,4	5,2	3,6	2,2	1,4
		260	26,4	21,4	18,0	15,4	11,1	7,7
		360	39,4	34,4	31,0	28,4	24,1	20,4
		390	43,3	38,3	34,9	32,3	28,0	24,3
		450	51,1	46,1	42,7	40,1	35,8	32,1
		500	56,5	52,6	49,2	46,6	42,3	38,6
$\phi 14$	51,3	160	15,5	9,3	5,8	4,0	2,5	1,6
		260	30,6	24,5	20,6	17,3	12,3	8,5
		360	45,8	39,7	35,7	32,5	27,4	23,1
		400	51,9	45,7	41,8	38,6	33,5	29,2
		450	59,5	53,3	49,4	46,2	41,1	36,8
		500	67,1	60,9	57,0	53,8	48,7	44,4
		550	74,6	68,5	64,6	61,3	56,3	51,9
$\phi 16$	67,0	180	21,0	13,6	9,0	6,4	4,0	2,7
		260	34,8	27,4	22,8	19,2	13,4	9,3
		360	52,2	44,8	40,1	36,5	30,7	25,7
		460	69,5	62,1	57,5	53,9	48,1	43,0
		500	76,4	69,1	64,4	60,8	55,0	49,9
		560	86,8	79,5	74,8	71,2	65,4	60,3
		600	93,8	86,4	81,7	78,1	72,3	67,3
$\phi 20$	104,7	220	34,3	24,6	18,4	13,4	8,2	6,1
		260	43,0	33,2	27,0	21,9	14,7	10,6
		360	64,7	54,9	48,7	43,6	36,2	30,3
		550	108,0	98,3	92,1	86,9	79,5	73,6
		600	116,7	106,9	100,7	95,6	88,2	82,3
		650	129,7	119,9	113,8	108,6	101,2	95,3
		700	138,4	128,6	122,4	117,3	109,9	104,0

\*For additional values please check GS 3,2/15-431-4 fire report, Characteristic yield strength  $f_{yk} = 500 \text{ N/mm}^2$

### b) Overlap joint application

Max, bond stress,  $f_{bd,FIRE}$ , depending on actual clear concrete cover for classifying the fire resistance,

It must be verified that the actual force in the bar during a fire,  $F_{s,T}$ , can be taken up by the bar connection of the selected length,  $l_{inst}$ , Note: Cold design for ULS is mandatory,

$$F_{s,T} \leq (l_{inst} - c_f) \cdot \phi \cdot \pi \cdot f_{bd,FIRE} \quad \text{where: } (l_{inst} - c_f) \geq l_s;$$

$l_s$  = lap length

$\phi$  = nominal diameter of bar

$l_{inst} - c_f$  = selected overlap joint length; this must be at least  $l_s$ ,

but may not be assumed to be more than  $80 \phi$

$f_{bd,FIRE}$  = bond stress when exposed to fire

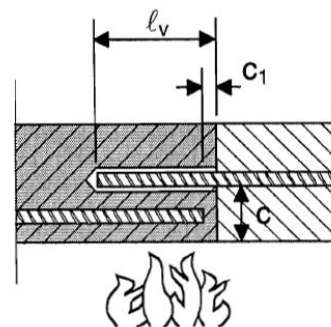

Critical temperature-dependent bond resistance,  $f_{bk,FIRE}$ , concerning “overlap joint” for Hilti HIT-RE 100-HC injection adhesive in relation to fire resistance class and required minimum concrete coverage c.

Concrete cover $c_{nom}$ [mm]	Characteristic bond resistance in case of fire, $f_{bk,fire}$ [N/mm <sup>2</sup> ]							
	R30	R60	R90	R120	R180	R240		
50	1,1	0,4	0,0	0,0	0,0	0,0		
60	1,6	0,6	0,4					
70	2,2	0,8	0,5	0,4				
80	3,0	1,1	0,6	0,5	0,4	0,3		
90	3,5	1,4	0,8	0,6				
100		1,8	1,1	0,7	0,5			
110		2,3	1,3	0,9	0,5			
120		2,9	1,6	1,1	0,6			
130		3,5	3,5	2,0	1,3	0,8	0,5	
140				2,4	1,6	0,9	0,6	
150				2,8	1,9	1,1	0,7	
160				3,3	2,2	1,3	0,9	
170				3,5	3,5	2,6	1,5	1,0
180						3,0	1,7	1,1
190	3,5	3,5	3,5	3,5	1,9	1,3		
200					2,2	1,5		
210					2,5	1,7		
220					2,8	1,9		
230				3,2	2,1	3,5		
240				2,3				
250				2,6				
260				2,8				
270	3,1	3,5						
280	3,5							
290								

## Materials

### Material quality

Part	Material
Rebar EN 1992-1-1	Bars and de-coiled rods class B or C with $f_{yk}$ and $k$ according to NDP or NCL of EN 1992-1-1 $f_{uk} = f_{tk} = k \cdot f_{yk}$

### Fitness for use

Some creep tests have been conducted in accordance with ETAG guideline 001 part 5 and TR 023 in the following conditions: **in dry environment at 50 °C during 90 days**,

These tests show an excellent behaviour of the post-installed connection made with HIT-RE 100-HC: low displacements with long term stability, failure load after exposure above reference load,

### Resistance to chemical substances

Chemical	Resistance	Chemical	Resistance
Acetic acid 100%	o	Methanol 100%	o
Acetic acid 10%	+	Peroxide of hydrogen 30%	o
Hydrochloric Acid 20%	+	Solution of phenol (sat.)	-
Nitric Acid 40%	-	Sodium hydroxide pH=14	+
Phosphoric Acid 40%	+	Solution of chlorine (sat.)	+
Sulphuric acid 40%	+	Solution of hydrocarbons (60 % vol Toluene, 30 % vol Xylene, 10 % vol Methyl naphthalene)	+
Ethyl acetate 100%	o	Salted solution 10%	+
Acetone 100%	-	sodium chloride	
Ammoniac 5%	o	Suspension of concrete (sat.)	+
Diesel 100%	+	Chloroform 100%	+
Gasoline 100%	+	Xylene 100%	+
Ethanol 96%	o		
Machine oils 100%	+		

- + resistant
- o resistant in short term (max, 48h) contact
- not resistant

### Electrical Conductivity

HIT-RE 100-HC in the hardened state **is not conductive electrically**, Its electric resistivity is  $1,4 \cdot 10^{10} \Omega \cdot m$  (DIN IEC 93 – 12,93), It is adapted well to realize electrically insulating anchorings (ex: railway applications, subway),

### Installation temperature range:

+5°C to +40°C

### Service temperature range

Hilti HIT-RE 100-HC injection mortar may be applied in the temperature ranges given below, An elevated base material temperature may lead to a reduction of the design bond resistance,

Temperature range	Base material temperature	Maximum long term base material temperature	Maximum short term base material temperature
Temperature range I	-40 °C to +80 °C	+50 °C	+80 °C

### Max short term base material temperature

Short-term elevated base material temperatures are those that occur over brief intervals, e.g, as a result of diurnal cycling,

### Max long term base material temperature

Long-term elevated base material temperatures are roughly constant over significant periods of time,

### Working time and curing time<sup>a)</sup>

Temperature IN the base material $T_{BM}$	Maximum working time $t_{work}$	Initial curing time $t_{cure,ini}^{b)}$	Minimum curing time $t_{cure}$
$5\text{ °C} \leq T_{BM} < 9\text{ °C}$	2,5 h	18 hours	72 hours
$10\text{ °C} \leq T_{BM} < 14\text{ °C}$	2 h	12 hours	48 hours
$15\text{ °C} \leq T_{BM} < 19\text{ °C}$	1 h	8 hours	24 hours
$20\text{ °C} \leq T_{BM} < 29\text{ °C}$	40 min	6 hours	18 hours
$30\text{ °C} \leq T_{BM} \leq 40\text{ °C}$	20 min	2 hours	6 hours

- a) The curing time data are valid for dry base material only, In wet base material the curing times must be doubled,  
b) After  $t_{cure,ini}$  has elapsed preparation work may continue

### Setting information

#### Installation equipment

Rebar – size	$\phi 8\text{-}\phi 16$	$\phi 18\text{-}\phi 40$
Rotary hammer	TE2(-A) – TE30(-A)	TE40 – TE80
Other tools	Blow out pump ( $h_{ef} \leq 10 \cdot d$ )	-
	Compressed air gun <sup>a)</sup> Set of cleaning brushes <sup>b)</sup> , dispenser, piston plug	

- a) Compressed air gun with extension hose for all drill holes deeper than 250 mm (for  $\phi 8$  to  $\phi 12$ ) or deeper than  $20 \cdot \phi$  (for  $\phi > 12$  mm)  
b) Automatic brushing with round brush for all drill holes deeper than 250 mm (for  $\phi 8$  to  $\phi 12$ ) or deeper than  $20 \cdot \phi$  (for  $\phi > 12$  mm)

#### Minimum concrete cover $c_{min}$ of the post-installed rebar

Drilling method	Rebar – size [mm]	Minimum concrete cover $c_{min}$ [mm]	
		Without drilling aid	With drilling aid
Hammer drilling (HD) and (HDB) <sup>1)</sup>	$\phi < 25$	$30 + 0,06 \cdot l_v \geq 2 \cdot \phi$	$30 + 0,02 \cdot l_v \geq 2 \cdot \phi$
	$\phi \geq 25$	$40 + 0,06 \cdot l_v \geq 2 \cdot \phi$	$40 + 0,02 \cdot l_v \geq 2 \cdot \phi$
Compressed air drilling (CA)	$\phi < 25$	$50 + 0,08 \cdot l_v$	$50 + 0,02 \cdot l_v$
	$\phi \geq 25$	$60 + 0,08 \cdot l_v \geq 2 \cdot \phi$	$60 + 0,02 \cdot l_v \geq 2 \cdot \phi$
Diamond coring dry (PCC) or wet (DD)	$\phi < 25$	Drill stand is used as drilling aid	$30 + 0,02 \cdot l_v \geq 2 \cdot \phi$
	$\phi \geq 25$		$40 + 0,02 \cdot l_v \geq 2 \cdot \phi$

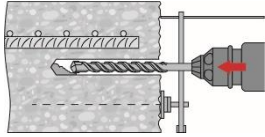

- 1) HDB = hollow drill bit Hilti TE-CD and TE-YD.

#### Dispenser and corresponding maximum embedment depth $l_{v,max}$

Dispenser	HDM 500			HDE 500			
	Mortar temperature	10-19°C	20-25°C	10-19°C	20-25°C		
Base material temperature	5-20°C	5-20°C	>20°C	5-20°C	5-20°C	>20°C	
$\phi$ [mm]	$l_{v,max}$ [mm]						
$\phi 8$ to $\phi 12$	500	1000	1000	500	1000	1000	
$\phi 14$					1200	1200	
$\phi 16$		700	1000		1500	1500	
$\phi 18$ to $\phi 20$					1300		
$\phi 22$ to $\phi 25$		500	700		700	1000	1000
$\phi 26$ to $\phi 32$						700	
$\phi 34$ to $\phi 40$						500	

### Drilling and cleaning diameters

Rebar [mm]	Drill bit diameters d <sub>0</sub> [mm]			Diamond core d <sub>0</sub> [mm]		Installation size [mm]	
	Hammer drill (HD)	Compressed air drill (CA)	Hollow Drill Bit (HDB)	Wet (DD)	Dry (PCC) <sup>b)</sup>	Brush HIT-RB	Air nozzle HIT-DL
φ8	12 (10 <sup>a)</sup> )	-	12	12 (10 <sup>a)</sup> )	-	12 (10 <sup>a)</sup> )	12 (10 <sup>a)</sup> )
φ10	14 (12 <sup>a)</sup> )	-	14 (12 <sup>a)</sup> )	14 (12 <sup>a)</sup> )	-	14 (12 <sup>a)</sup> )	14 (12 <sup>a)</sup> )
φ12	16 (14 <sup>a)</sup> )	-	16 (14 <sup>a)</sup> )	16 (14 <sup>a)</sup> )	-	16 (14 <sup>a)</sup> )	16 (14 <sup>a)</sup> )
	-	17	-	-	-	18	16
φ14	18	17	18	18	-	18	18
φ16	20	-	20	20	-	20	20
	-	20	-	-	-	22	20
φ18	22	22	22	22	-	22	22
φ20	25 (24 <sup>a)</sup> )	-	25	25	-	25 (24 <sup>a)</sup> )	25 (24 <sup>a)</sup> )
	-	26	-	-	-	28	25
φ22	28	28	28	28	-	28	28
φ24	32	32	32	32	-	32	32
	-	-	-	-	35	-	
φ25	32 (30 <sup>a)</sup> )	32 (30 <sup>a)</sup> )	32	32 (30 <sup>a)</sup> )	-	32 (30 <sup>a)</sup> )	
	-	-	-	-	35	-	
φ26	35	35	-	35	35	35	
φ28	35	35	-	35	35	35	
φ30	-	35	-	35	35	35	
	37	-	-	-	-	37	
φ32	40	40	-	40	47	40	
φ34	-	42	-	42	47	42	
	45	-	-	-	-	45	
φ36	45	45	-	-	47	45	
	-	-	-	47	-	47	
φ40	-	-	-	52	52	52	
	55	57	-	-	-	55	

- a) Both of a given values can be used,  
b) No cleaning required,

## Setting instructions

\*For detailed information on installation see instruction for use given with the package of the product,



### Safety regulations,

Review the Material Safety Data Sheet (MSDS) before use for proper and safe handling! Wear well-fitting protective goggles and protective gloves when working with Hilti HIT-RE 100-HC.

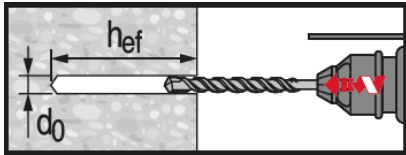

### Hammer drilled hole

For dry and wet concrete,

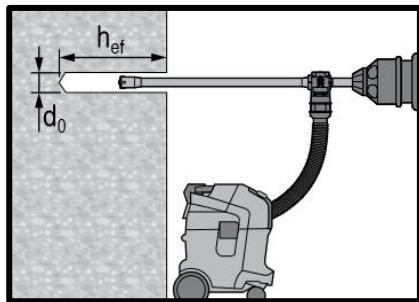

### Hammer drilled hole with Hollow Drilled Bit (HDB)

No cleaning required,

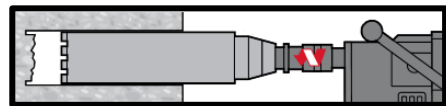

### Diamond Drilling (DD)

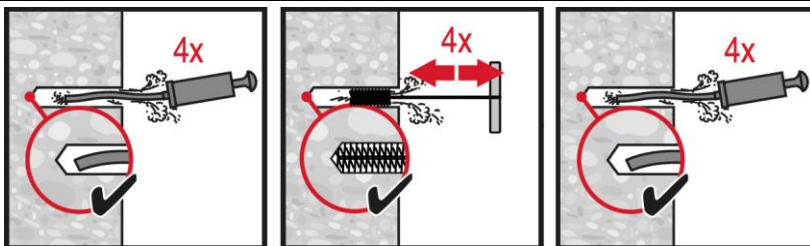

### Hammer Drilling:

#### Manual cleaning (MC)

for drill diameters  $d_0 \leq 20$  mm and drill hole depth  $h_0 \leq 10 \cdot d_0$ ,

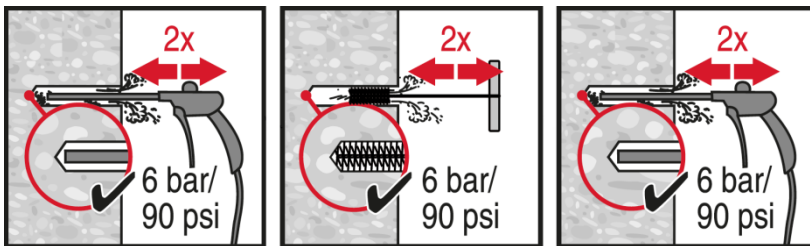

### Hammer Drilling:

#### Compressed air cleaning (CAC)

for all drill hole diameters  $d_0$  and drill hole depths  $h_0 \leq 20 \cdot d_0$ ,

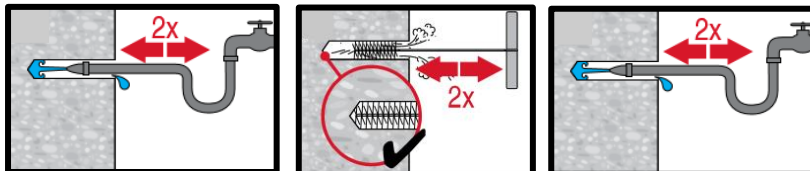

### Wet diamond coring:

#### Compressed air cleaning (CAC)

for all drill hole diameters  $d_0$  and drill hole depths  $h_0$ ,

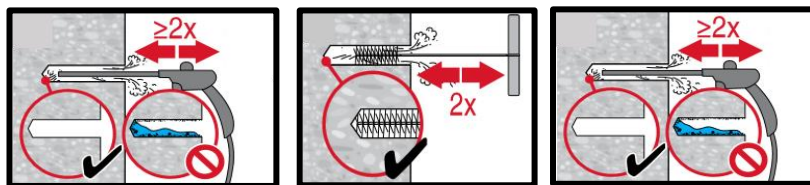



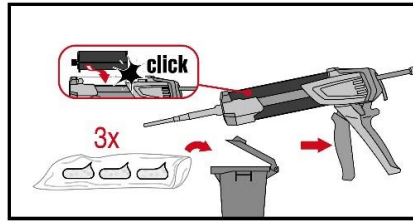
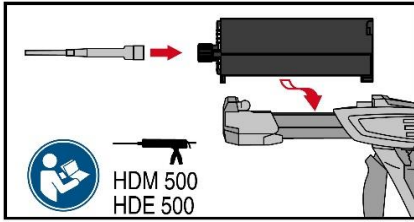

Injection system preparation,

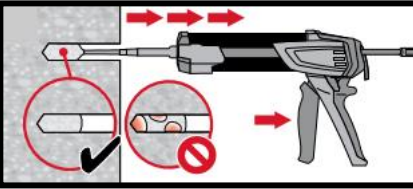
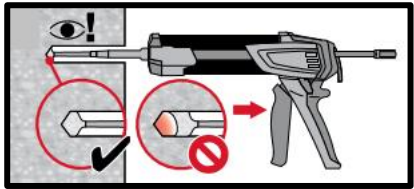

Injection method for drill hole depth  
 $h_{ef} \leq 250$  mm,

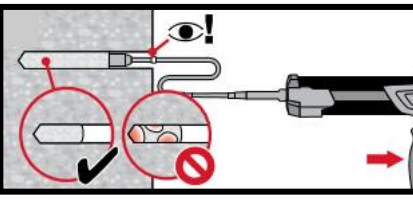
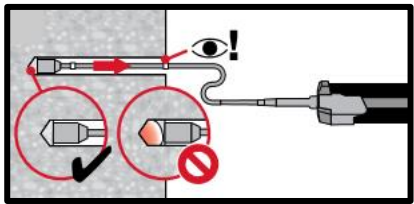

Injection method for drill hole depth  
 $h_{ef} > 250$  mm,

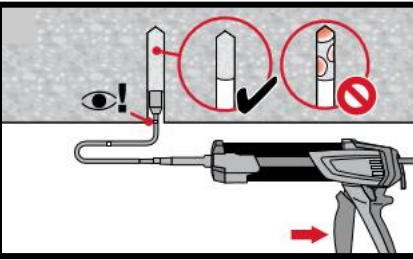
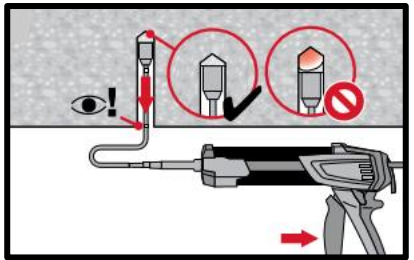

Injection method for overhead  
application,

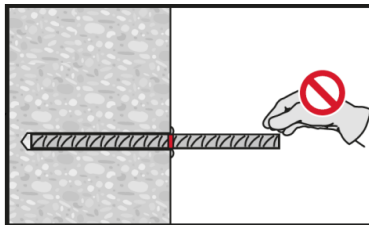
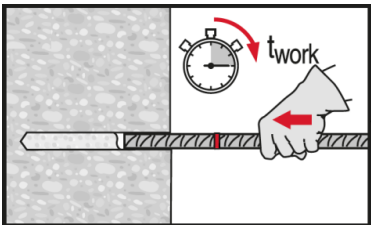

Setting element, observe working time  
“ $t_{work}$ ”,

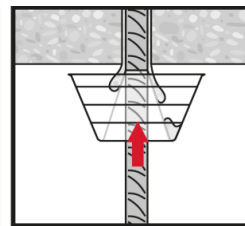
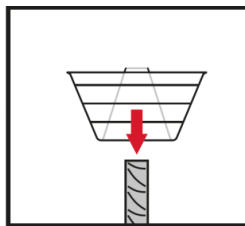
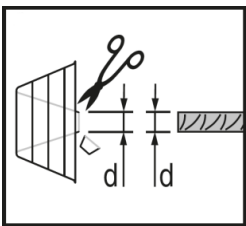

Setting element for overhead  
applications, observe working time “ $t_{work}$ ”,

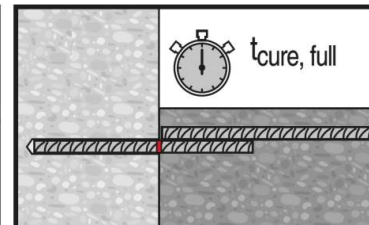
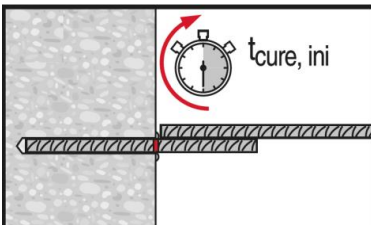
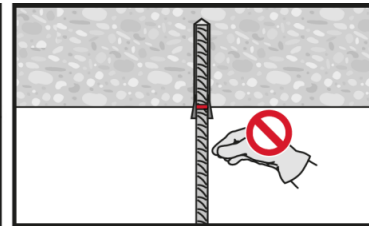
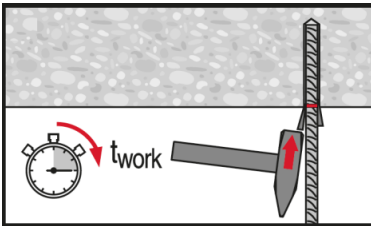

Apply full load only after curing time  
“ $t_{cure}$ ”,





Concrete

Chemical anchors

Mechanical anchors

Plastic/Light duty metal anchors

Insulation anchors

# HIT-HY 110 injection mortar

Anchor design (ETAG 001) / Rods&Sleeves / Concrete

Concrete

Chemical anchors

Mechanical anchors

Plastic/Light duty metal anchors

Insulation anchors

## Injection mortar system



Hilti HIT-HY 110  
330 ml foil pack  
(also available as  
500 ml and 1.400  
ml foil pack)



Anchor rod:  
HIT-V  
HIT-V-F  
HIT-V-R  
HIT-V-HCR  
(M8-M30)

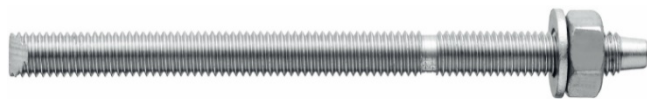

Anchor rod:  
HAS-(E)  
HAS-(E)R  
HAS-(E)RHCR  
(M8-M30)



Internally threaded  
sleeve:  
HIS-N  
HIS-RN  
(M8-M20)

## Benefits

- Suitable non-cracked concrete C 20/25 to C 50/60
- High corrosion<sup>a)</sup> / corrosion resistant
- Suitable for dry and water saturated concrete
- Small edge distance and anchor spacing possible
- Large diameter applications
- In service temperature range up to 120°C short term / 72°C long term

a) Applications only for HIT-V rods

## Base material



Concrete  
(non-cracked)



Dry concrete



Wet concrete

## Load conditions

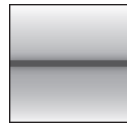

Static/  
quasi-static

## Installation conditions

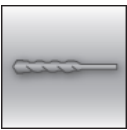

Hammer  
drilling

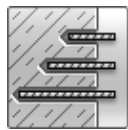

Variable  
embedment  
depth

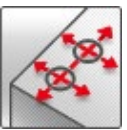

Small edge  
distance and  
spacing

## Other informations



European  
Technical  
Assessment



CE  
conformity

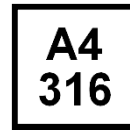

Corrosion  
resistance



High  
corrosion  
resistance<sup>a)</sup>

a) Applications only for HIT-V rods

## Approvals / certificates

Description	Authority / Laboratory	No. / date of issue
European technical assessment <sup>a)</sup>	DIBt, Berlin	ETA-08/0341 / 2013-03-18

a) All data given in this section according to ETA-08/0341 issue 2013-03-18.

## Static and quasi-static loading (for a single anchor)

### All data in this section applies to

- Correct setting (See setting instruction)
- No edge distance and spacing influence
- Steel failure
- Base material thickness, as specified in the table
- One typical embedment depth, as specified in the table
- One anchor material, as specified in the tables
- Concrete C 20/25,  $f_{ck,cube} = 25 \text{ N/mm}^2$
- Temperate range I  
(min. base material temperature  $-40^\circ\text{C}$ , max. long term/short term base material temperature:  $+24^\circ\text{C}/40^\circ\text{C}$ )

### Embedment depth and base material thickness

Anchor size	M8	M10	M12	M16	M20	M24	M27	M30
<b>HIT-V</b>								
Typical embedment depth $h_{ef}$ [mm]	80	90	110	125	170	210	240	270
Base material thickness $h$ [mm]	110	120	140	165	220	270	300	340
<b>HIS-N</b>								
Typical embedment depth [mm]	90	110	125	170	205	-	-	-
Base material thickness $h$ [mm]	120	150	170	230	270	-	-	-

### Characteristic resistance

Anchor size	M8	M10	M12	M16	M20	M24	M27	M30	
Tension $N_{Rk}$ [kN]	HIT-V 5.8	18,0	29,0	42,0	56,5	90,8	126,7	152,7	178,1
	HIS-N 8.8	25,0	40,0	60,0	119,0	109,0	-	-	-
Shear $V_{Rk}$ [kN]	HIT-V 5.8	9,0	15,0	21,0	39,0	61,0	88,0	115,0	140,0
	HIS-N 8.8	13,0	23,0	39,0	59,0	55,0	-	-	-

### Design resistance

Anchor size	M8	M10	M12	M16	M20	M24	M27	M30	
Tension $N_{Rd}$ [kN]	HIT-V 5.8	12,0	17,3	25,3	26,9	43,2	60,3	72,7	84,8
	HIS-N 8.8	17,5	26,7	40,0	62,2	74,1	-	-	-
Shear $V_{Rd}$ [kN]	HIT-V 5.8	7,2	12,0	16,8	31,2	48,8	70,4	92,0	112,0
	HIS-N 8.8	10,4	18,4	26,0	39,3	36,7	-	-	-

### Recommended loads <sup>a)</sup>

Anchor size	M8	M10	M12	M16	M20	M24	M27	M30	
Tension $N_{Rec}$ [kN]	HIT-V 5.8	8,6	12,3	18,1	19,2	30,9	43,1	51,9	60,6
	HIS-N 8.8	12,5	19,0	28,6	44,4	53,0	-	-	-
Shear $V_{Rec}$ [kN]	HIT-V 5.8	5,1	8,6	12,0	22,3	34,9	50,3	65,7	80,0
	HIS-N 8.8	7,4	13,1	18,6	28,1	26,2	-	-	-

a) With overall partial safety factor for action  $\gamma=1,4$ . The partial safety factors for action depend on the type of loading and shall be taken from national regulations.

**Mechanical properties for HIT-V and HAS**

Anchor size		M8	M10	M12	M16	M20	M24	M27	M30	
Nominal tensile strength $f_{uk}$	HIT-V 5.8	[N/mm <sup>2</sup> ]	500	500	500	500	500	500	500	
	HAS-(E) 5.8		800	800	800	800	800	800	800	
	HIT-V-R		700	700	700	700	700	700	500	500
	HAS-(E)R		800	800	800	800	800	700	700	700
Yield strength $f_{yk}$	HIT-V-HCR	[N/mm <sup>2</sup> ]	400	400	400	400	400	400	400	
	HAS-(E)-HCR		640	640	640	640	640	640	640	
	HIT-V 5.8		450	450	450	450	450	450	210	210
	HAS-(E) 5.8		600	600	600	600	600	400	400	400
Stressed cross-section $A_s$	HIT-V	[mm <sup>2</sup> ]	36,6	58,0	84,3	157	245	353	459	561
	HAS-(E)		32,8	52,3	76,2	144,0	225,0	324,0	427	519
Moment of resistance $W$	HIT-V	[mm <sup>3</sup> ]	31,2	62,3	109	277	541	935	1387	1874
	HAS-(E)		27,0	54,1	93,8	244,0	474,0	809,0	1274	1706

**Mechanical properties for HIS-N**

Anchor size		M8	M10	M12	M16	M20	
Nominal tensile strength $f_{uk}$	HIS-N	[N/mm <sup>2</sup> ]	490	490	460	460	460
	Screw 8.8		800	800	800	800	800
	HIS-RN		700	700	700	700	700
	Screw A4-70		700	700	700	700	700
Yield strength $f_{yk}$	HIS-N	[N/mm <sup>2</sup> ]	410	410	375	375	375
	Screw 8.8		640	640	640	640	640
	HIS-RN		350	350	350	350	350
	Screw A4-70		450	450	450	450	450
Stressed cross-section	HIS-(R)N	[mm <sup>2</sup> ]	51,5	108,0	169,1	256,1	237,6
	Screw		36,6	58	84,3	157	245
Moment of resistance $W$	HIS-(R)N	[mm <sup>3</sup> ]	145	430	840	1595	1543
	Screw		31,2	62,3	109	277	541

### Material quality for HIT-V

Part	Material
<b>Zinc coated steel</b>	
Threaded rod, HIT-V 5.8 (F) HAS-(E) M8 to M24	Strength class 5.8; Elongation at fracture A5 > 8% ductile Electroplated zinc coated $\geq 5\mu\text{m}$ ; (F) hot dip galvanized $\geq 45\mu\text{m}$
Threaded rod, HIT-V 8.8 (F) HAS-(E) M27 to M30	Strength class 8.8; Elongation at fracture A5 > 12% ductile Electroplated zinc coated $\geq 5\mu\text{m}$ ; (F) hot dip galvanized $\geq 45\mu\text{m}$
Washer	Electroplated zinc coated $\geq 5\mu\text{m}$ , hot dip galvanized $\geq 45\mu\text{m}$
Nut	Strength class of nut adapted to strength class of threaded rod. Electroplated zinc coated $\geq 5\mu\text{m}$ , hot dip galvanized $\geq 45\mu\text{m}$
<b>Stainless Steel</b>	
Threaded rod, HIT-V-R HAS-(E)R	Strength class 70 for $\leq M24$ and strength class 50 for $> M24$ ; Elongation at fracture A5 > 8% ductile Stainless steel 1.4401; 1.4404; 1.4578; 1.4571; 1.4439; 1.4362
Washer	Stainless steel 1.4401, 1.4404, 1.4578, 1.4571, 1.4439, 1.4362 EN 10088-1:2014
Nut	Stainless steel 1.4401, 1.4404, 1.4578, 1.4571, 1.4439, 1.4362 EN 10088-1:2014
<b>High corrosion resistant steel</b>	
Threaded rod, HIT-V-HCR HAS-(E)HCR	Strength class 80 for $\leq M20$ and class 70 for $> M20$ , Elongation at fracture A5 > 8% ductile High corrosion resistance steel 1.4529; 1.4565;
Washer	High corrosion resistant steel 1.4529, 1.4565 EN 10088-1:2014
Nut	High corrosion resistant steel 1.4529, 1.4565 EN 10088-1:2014

### Material quality for HIS-N

Part	Material
HIS-N	Internal threaded sleeve C-steel 1.0718 Steel galvanized $\geq 5\mu\text{m}$
	Screw 8.8 Strength class 8.8, A5 > 8 % Ductile Steel galvanized $\geq 5\mu\text{m}$
HIS-RN	Internal threaded sleeve Stainless steel 1.4401, 1.4571
	Screw 70 Strength class 70, A5 > 8 % Ductile Stainless steel 1.4401; 1.4404, 1.4578; 1.4571; 1.4439; 1.4362

### Setting information

#### Installation temperature range:

-5°C to +40°C

#### In service temperature range

Hilti HIT-HY 110 injection mortar may be applied in the temperature ranges given below. An elevated base material temperature may lead to a reduction of the design bond resistance.

Temperature range	Base material temperature	Max. long term base material temperature	Max. short term base material temperature
Temperature range I	-40 °C to + 40 °C	+ 24 °C	+ 40 °C
Temperature range II	-40 °C to + 80 °C	+ 50 °C	+ 80 °C
Temperature range II	-40 °C to + 120 °C	+ 72 °C	+ 120 °C

**Max. short term base material temperature**

Short term elevated base material temperatures are those that occur over brief intervals, e.g. as a result of diurnal cycling.

**Max. long term base material temperature**

Long term elevated base material temperatures are roughly constant over significant periods of time.

**Working time and curing time**

Temperature in the anchorage base	Maximum working time $t_{work}$	Minimum curing time $t_{cure}$
$-5^{\circ}\text{C} < T_{BM} \leq 0^{\circ}\text{C}$	90 min	9 h
$0^{\circ}\text{C} < T_{BM} \leq 5^{\circ}\text{C}$	45 min	4,5 h
$5^{\circ}\text{C} < T_{BM} \leq 10^{\circ}\text{C}$	25 min	2 h
$10^{\circ}\text{C} < T_{BM} \leq 20^{\circ}\text{C}$	6 min	90 min
$20^{\circ}\text{C} < T_{BM} \leq 30^{\circ}\text{C}$	4 min	50 min
$30^{\circ}\text{C} < T_{BM} \leq 40^{\circ}\text{C}$	2 min	40 min

The curing time data are valid for dry base material only. In wet base material the curing times must be doubled.

**Setting details for HIT-V and HAS**

Anchor size	M8	M10	M12	M16	M20	M24	M27	M30	
Nominal diameter of drill bit $d_0$ [mm]	10	12	14	18	22	28	30	35	
Diameter of element $d$ [mm]	8	10	12	16	20	24	27	30	
Effective anchorage and drill hole depth <sup>a)</sup> for HIT-V	$h_{ef,min}$ [mm]	60	60	70	80	90	100	110	120
	$h_{ef,max}$ [mm]	160	200	240	320	400	480	540	600
Effective anchorage and drill hole depth <sup>a)</sup> for HAS	$h_{ef}$ [mm]	80	90	110	125	170	210	240	270
Minimum base material thickness $h_{min}$ [mm]	$h_{ef} + 30$			$h_{ef} + 2 d_0$					
Diameter of clearance hole in the fixture $d_f \leq$ [mm]	9	12	14	18	22	26	30	33	
Torque moment <sup>b)</sup> $T_{max}$ [Nm]	10	20	40	80	150	200	270	300	
Min. spacing $s_{min}$ [mm]	40	50	60	80	100	120	135	150	
Min. edge distance $c_{min}$ [mm]	40	50	60	80	100	120	135	150	
Critical spacing for splitting failure $s_{cr,sp}$ [mm]	$2 C_{cr,sp}$								
Critical edge distance for splitting failure <sup>c)</sup> $C_{cr,sp}$ [mm]	$1,0 \cdot h_{ef}$ for $h / h_{ef} \geq 2,0$								
	$4,6 h_{ef} - 1,8 h$ for $2,0 > h / h_{ef} > 1,3$								
	$2,26 h_{ef}$ for $h / h_{ef} \leq 1,3$								
Critical spacing for concrete cone failure $s_{cr,N}$ [mm]	$2 C_{cr,N}$								
Critical edge distance for concrete cone failure <sup>d)</sup> $C_{cr,N}$ [mm]	$1,5 h_{ef}$								

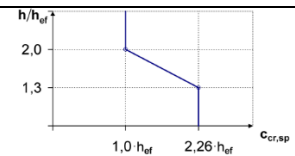

For spacing (edge distance) smaller than critical spacing (critical edge distance) the design loads have to be reduced.

- $h_{ef,min} \leq h_{ef} \leq h_{ef,max}$  ( $h_{ef}$ : embedment depth)
- Maximum recommended torque moment to avoid splitting failure during installation with minimum spacing anchor edge distance
- $h$ : base material thickness ( $h \geq h_{min}$ )
- The critical edge distance for concrete cone failure depends on the embedment depth  $h_{ef}$  and the design bond resistance. The simplified formula given in this table is on the safe side.

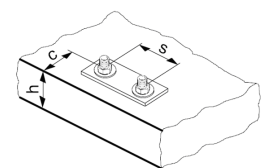

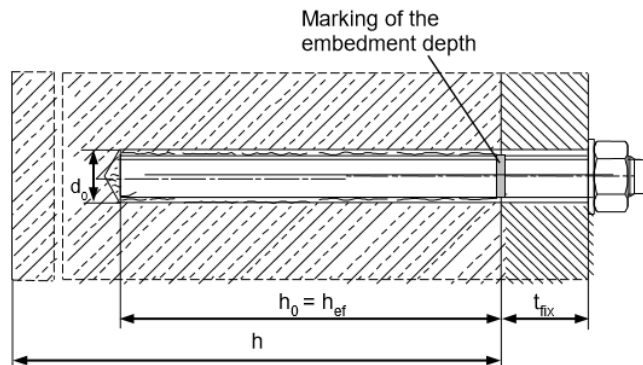

### Setting details for HIS-N

Anchor size		M8	M10	M12	M16	M20
Nominal diameter of drill bit	$d_0$ [mm]	14	18	22	28	32
Diameter of element	$d$ [mm]	12,5	16,5	20,5	25,4	27,6
Effective anchorage and drill hole depth	$h_{ef}$ [mm]	90	110	125	170	205
Minimum base material thickness	$h_{min}$ [mm]	120	150	170	230	270
Diameter of clearance hole in the fixture	$d_f$ [mm]	9	12	14	18	22
Thread engagement length min-max	$h_s$ [mm]	8-20	10-25	12-30	16-40	20-50
Min. spacing	$s_{min}$ [mm]	40	45	55	65	90
Min. edge distance	$c_{min}$ [mm]	40	45	55	65	90
Critical spacing for splitting failure	$s_{cr,sp}$ [mm]	$2 C_{cr,sp}$				
Critical edge distance for splitting failure <sup>a)</sup>	$c_{cr,sp}$ [mm]	$1,0 \cdot h_{ef}$ for $h / h_{ef} \geq 2,0$				
		$4,6 h_{ef} - 1,8 h$ for $2,0 > h / h_{ef} > 1,3$				
		$2,26 h_{ef}$ for $h / h_{ef} \leq 1,3$				
Critical spacing for concrete cone failure	$s_{cr,N}$ [mm]	$2 C_{cr,N}$				
Critical edge distance for concrete cone failure <sup>b)</sup>	$c_{cr,N}$ [mm]	$1,5 h_{ef}$				
Torque moment <sup>c)</sup>	$T_{max}$ [Nm]	10	20	40	80	150

For spacing (edge distance) smaller than critical spacing (critical edge distance) the design loads have to be reduced.

- $h$ : base material thickness ( $h \geq h_{min}$ ),  $h_{ef}$ : embedment depth
- The critical edge distance for concrete cone failure depends on the embedment depth  $h_{ef}$  and the design bond resistance. The simplified formula given in this table is on the safe side.
- Maximum recommended torque moment to avoid splitting failure during installation with minimum spacing and/or edge distance.

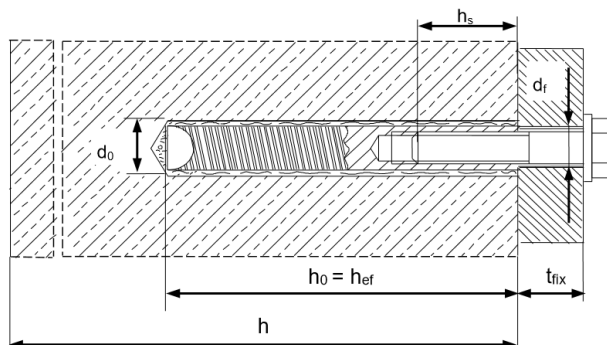
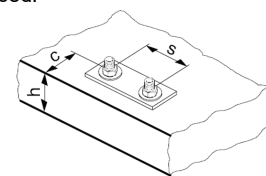







## Installation equipment

Anchor size	M8	M10	M12	M16	M20	M24	M27	M30
Rotary hammer	HIT-V / HAS			TE 2– TE 30			TE 40 – TE 80	
	HIS-N			TE 2– TE 30			TE 40 – TE 80	
Other tools	compressed air gun or blow out pump set of cleaning brushes, dispenser							

## Drilling and cleaning parameters

HIT-V HAS	HIS-N	Hammer drill	Brush HIT-RB	Piston plug HIT-SZ
		$d_0$ [mm]	size [mm]	
				
M8	-	10	10	-
M10	-	12	12	12
M12	M8	14	14	14
M16	M10	18	18	18
M20	M12	22	22	22
M24	M16	28	28	28
M27	-	30	30	30
-	M20	32	32	32
M30	-	35	35	35

## Setting instructions

\*For detailed information on installation see instruction for use given with the package of the product.



### Safety regulations.

Review the Material Safety Data Sheet (MSDS) before use for proper and safe handling! Wear well-fitting protective goggles and protective gloves when working with Hilti HIT-HY 110.

## Drilling

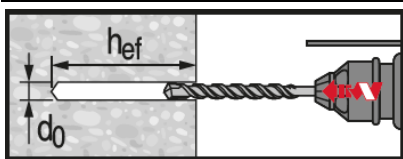

Hammer drilled hole (HD)

## Cleaning

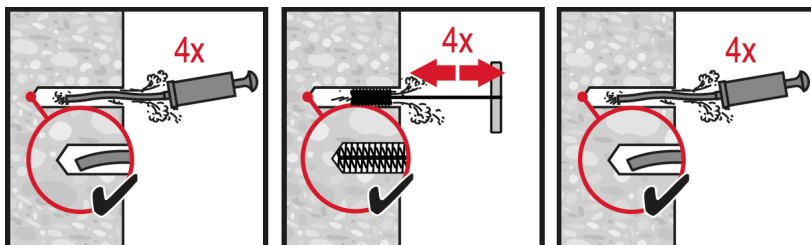

### Manual cleaning (MC) Non-cracked concrete only

for drill diameters  $d_0 \leq 18$  mm and drill hole depth  $h_0 \leq 10 \cdot d$  or  $h_0 \leq 160$ .



### Compressed air cleaning (CAC)

for all drill hole diameters  $d_0$  and drill hole depths  $h_0$ .

## Injection system

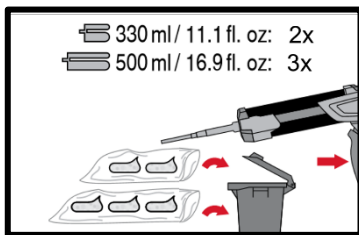
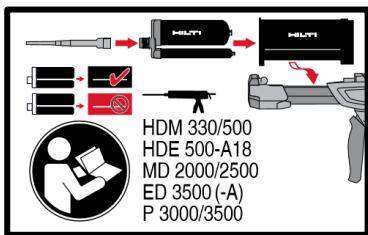

Injection system preparation.

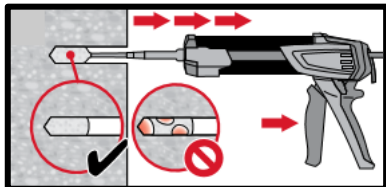
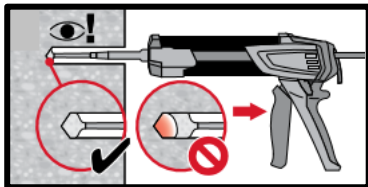

Injection method for drill hole depth  $h_{ef} \leq 250$  mm.

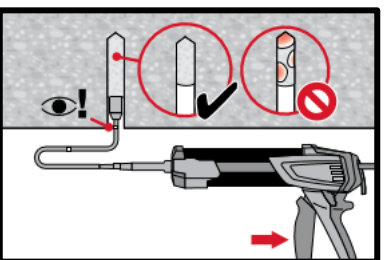
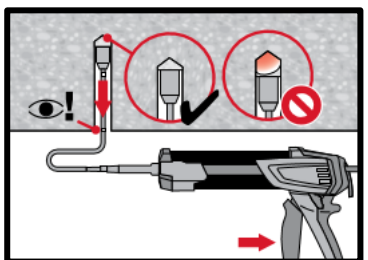

Injection method for overhead application or installation with embedment depth  $h_{ef} > 250$  mm.

## Setting the element

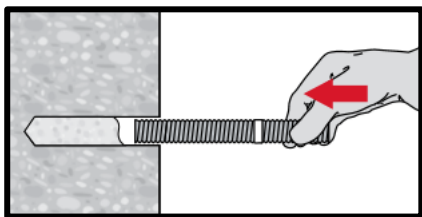

Setting element, observe working time " $t_{work}$ ".

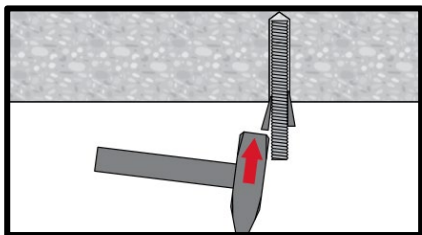

Setting element for overhead applications, observe working time " $t_{work}$ ".

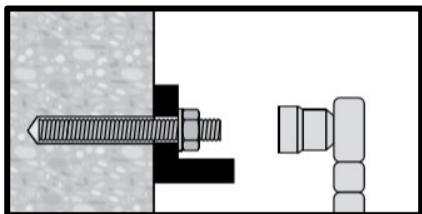





Loading the anchor: After required curing time  $t_{cure}$  the anchor can be loaded.

# HIT-HY 110 injection mortar

Anchor design (ETAG 001) / Rebar elements / Concrete

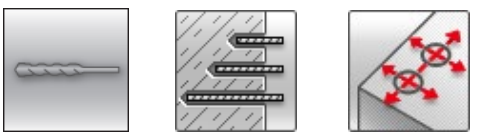
Injection mortar system	Benefits
 <p>Hilti HIT-HY 110 330 ml foil pack (also available as 500 ml and 1.400 ml foil pack)</p> <p>Rebar B St 500 S (<math>\phi 8</math>-<math>\phi 25</math>)</p>	<ul style="list-style-type: none"> <li>- Suitable non-cracked concrete C 20/25 to C 50/60</li> <li>- Suitable for dry and water saturated concrete</li> <li>- Small edge distance and anchor spacing possible</li> <li>- Large diameter applications</li> <li>- In service temperature range up to 120°C short term / 72°C long term</li> </ul>

Base material	Load conditions
 <p>Concrete (non-cracked)    Dry concrete    Wet concrete</p>	 <p>Static/ quasi-static</p>
Installation conditions	Other informations
 <p>Hammer drilling    Variable embedment depth    Small edge distance and spacing</p>	 <p>European Technical Assessment    CE conformity</p>

b) Applications only for HIT-V rods

### Approvals / certificates

Description	Authority / Laboratory	No. / date of issue
European technical assessment <sup>a)</sup>	DIBt, Berlin	ETA-08/0341 / 2013-03-18

b) All data given in this section according to ETA-08/0341 issue 2013-03-18.

### Static and quasi-static loading (for a single anchor)

#### All data in this section applies to

- Correct setting (See setting instruction)
- No edge distance and spacing influence
- Steel failure
- Base material thickness, as specified in the table
- One typical embedment depth, as specified in the table
- Anchor material: Rebar B St 500 S
- Concrete C 20/25,  $f_{ck,cube} = 25 \text{ N/mm}^2$
- Temperature range I  
(min. base material temperature -40°C, max. long term/short term base material temperature: +24°C/40°C)

### Embedment depth <sup>a)</sup> and base material thickness for static and quasi-static loading data

Anchor- size	φ8	φ10	φ12	φ14	φ16	φ20	φ25
Typical embedment depth [mm]	80	90	110	125	170	210	240
Base material thickness [mm]	110	120	140	165	220	270	300

a) The allowed range of embedment depth is shown in the setting details. The corresponding load values can be calculated according to the simplified design method.

### Characteristic resistance

Anchor- size	φ8	φ10	φ12	φ14	φ16	φ20	φ25
Tensile $N_{Rk}$	17,1	24,0	35,2	41,2	54,7	80,1	123,7
Shear $V_{Rk}$ [kN]	9,3	14,7	20,7	28,0	36,7	57,3	90,0

### Design resistance

Anchor- size	φ8	φ10	φ12	φ14	φ16	φ20	φ25
Tensile $N_{Rd}$	11,4	13,4	19,6	19,6	26,0	38,1	58,9
Shear $V_{Rd}$ [kN]	9,3	14,7	20,7	28,0	36,7	57,3	90,0

### Recommended loads <sup>a)</sup>

Anchor- size	φ8	φ10	φ12	φ14	φ16	φ20	φ25
Tensile $N_{Rec}$	8,1	9,5	14,0	14,0	18,6	27,2	42,1
Shear $V_{Rec}$ [kN]	6,7	10,5	14,8	20,0	26,2	41,0	64,3

a) With overall partial safety factor for action  $\gamma = 1,4$ . The partial safety factors for action depend on the type of loading and shall be taken from national regulations.

## Materials

### Mechanical properties

Anchor size	φ8	φ10	φ12	φ14	φ16	φ20	φ25
Nominal tensile strength $f_{uk}$ [N/mm <sup>2</sup> ]	550	550	550	550	550	550	550
Yield strength $f_{yk}$ [N/mm <sup>2</sup> ]	500	500	500	500	500	500	500
Stressed cross-section $A_s$ [mm <sup>2</sup> ]	50,3	78,5	113,1	153,9	201,1	314,2	490,9
Moment of resistance $W$ [mm <sup>3</sup> ]	50,3	98,2	169,6	269,4	402,1	785,4	1534

### Material quality

Part	Material
Rebar EN 1992-1-1	Mechanical properties according to DIN 488-1:1984 Geometry according to DIN 488-21:1986

## Setting information

**Installation temperature range:**  
-5°C to +40°C

### In service temperature range

Hilti HIT-HY 110 injection mortar may be applied in the temperature ranges given below. An elevated base material temperature may lead to a reduction of the design bond resistance.

Temperature range	Base material temperature	Max. long term base material temperature	Max. short term base material temperature
Temperature range I	- 40 °C to + 40 °C	+ 24 °C	+ 40 °C
Temperature range II	- 40 °C to + 80 °C	+ 50 °C	+ 80 °C
Temperature range III	- 40 °C to + 120 °C	+ 72 °C	+ 120 °C

### Max. short term base material temperature

Short term elevated base material temperatures are those that occur over brief intervals, e.g. as a result of diurnal cycling.

### Max. long term base material temperature

Long term elevated base material temperatures are roughly constant over significant periods of time.

### Working time and curing time

Temperature in the anchorage base	Maximum working time $t_{work}$	Minimum curing time $t_{cure}$
-5°C < $T_{BM}$ ≤ 0°C	90 min	9 h
0°C < $T_{BM}$ ≤ 5°C	45 min	4,5 h
5°C < $T_{BM}$ ≤ 10°C	25 min	2 h
10°C < $T_{BM}$ ≤ 20°C	6 min	90 min
20°C < $T_{BM}$ ≤ 30°C	4 min	50 min
30°C < $T_{BM}$ ≤ 40°C	2 min	40 min

The curing time data are valid for dry base material only. In wet base material the curing times must be doubled.

### Setting details

Anchor size		φ8	φ10	φ12	φ14	φ16	φ20	φ25
Nom. diameter of drill bit	$d_0$ [mm]	10 / 12 <sup>a)</sup>	12 / 14 <sup>a)</sup>	14 <sup>a)</sup> / 16 <sup>a)</sup>	18	20	25	32
Effective anchorage and drill hole depth range	$h_{ef,min}$ [mm]	60	60	70	75	80	90	100
	$h_{ef,max}$ [mm]	160	200	240	280	320	400	500
Minimum base material thickness	$h_{min}$ [mm]	$h_{ef} + 30$ mm ≥ 100 mm			$h_{ef} + 2 d_0$			
Min. spacing	$s_{min}$ [mm]	40	50	60	70	80	100	125
Min. edge distance	$c_{min}$ [mm]	40	50	60	70	80	100	125
Critical spacing for splitting failure	$s_{cr,sp}$ [mm]	2 $C_{cr,sp}$						
Critical edge distance for splitting failure <sup>b)</sup>	$C_{cr,sp}$ [mm]	1,0 · $h_{ef}$		for $h / h_{ef} \geq 2,0$				
		4,6 $h_{ef}$ - 1,8 h		for $2,0 > h / h_{ef} > 1,3$				
		2,26 $h_{ef}$		for $h / h_{ef} \leq 1,3$				
Critical spacing for concrete cone failure	$s_{cr,N}$ [mm]	2 $C_{cr,N}$						
Critical edge distance for concrete cone failure <sup>c)</sup>	$C_{cr,N}$ [mm]	1,5 $h_{ef}$						

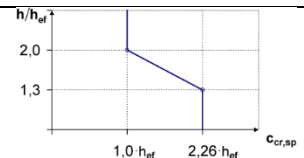

For spacing (edge distance) smaller than critical spacing (critical edge distance) the design loads have to be reduced.

- a) Each of the two given values can be used.  
 b)  $h$ : base material thickness ( $h \geq h_{min}$ ),  $h_{ef}$ : embedment depth  
 c) The critical edge distance for concrete cone failure depends on the embedment depth  $h_{ef}$  and the design bond resistance. The simplified formula given in this table is on the safe side.

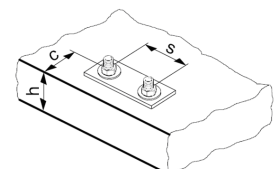

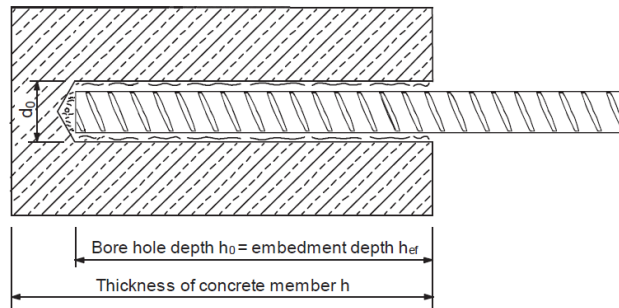

### Installation equipment

Anchor size	$\phi 8$	$\phi 10$	$\phi 12$	$\phi 14$	$\phi 16$	$\phi 20$	$\phi 25$
Rotary hammer	TE 2 – TE 30					TE 40 – TE 70	
Other tools	compressed air gun or blow out pump set of cleaning brushes, dispenser						

### Drilling and cleaning parameters

Rebar	Hammer drilling (HD)	Brush HIT-RB	Piston plug HIT-SZ
	$d_0$ [mm]	size [mm]	
$\phi 8$	10 / 12 <sup>a)</sup>	10 / 12 <sup>a)</sup>	- / 12
$\phi 10$	12 / 14 <sup>a)</sup>	12 / 14 <sup>a)</sup>	12 / 14 <sup>a)</sup>
$\phi 12$	14 / 16 <sup>a)</sup>	14 / 16 <sup>a)</sup>	14 / 16 <sup>a)</sup>
$\phi 14$	18	18	18
$\phi 16$	20	20	20
$\phi 20$	25	25	25
$\phi 25$	32	32	32

a) Each of the two given values can be used



## Setting instructions

\*For detailed information on installation see instruction for use given with the package of the product.



### Safety regulations.

Review the Material Safety Data Sheet (MSDS) before use for proper and safe handling! Wear well-fitting protective goggles and protective gloves when working with Hilti HIT-HY 110.

### Drilling

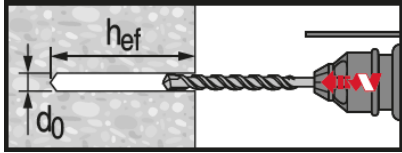

**Hammer drilled hole (HD)**

### Cleaning

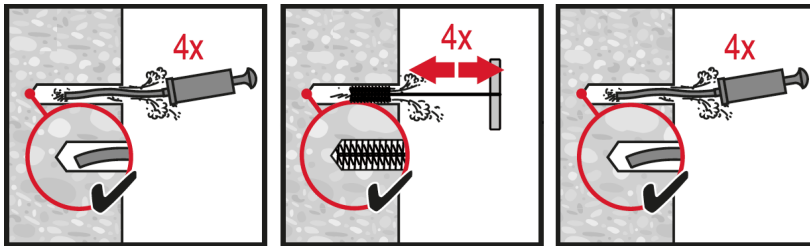

**Manual cleaning (MC)**  
Non-cracked concrete only

for drill diameters  $d_0 \leq 18$  mm and drill hole depth  $h_0 \leq 10 \cdot d$  or  $h_0 \leq 160$ .

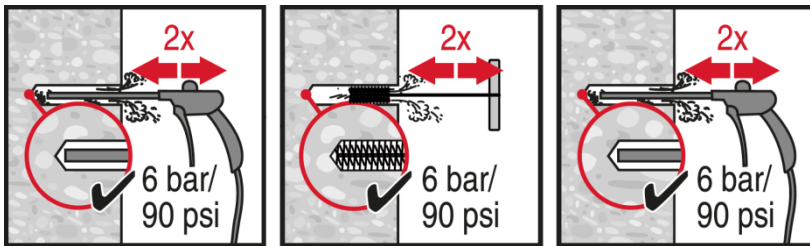

**Compressed air cleaning (CAC)**

for all drill hole diameters  $d_0$  and drill hole depths  $h_0$ .

### Injection system

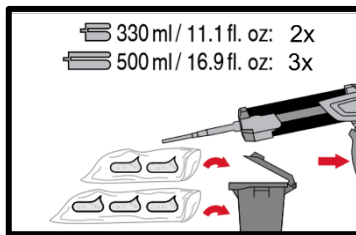
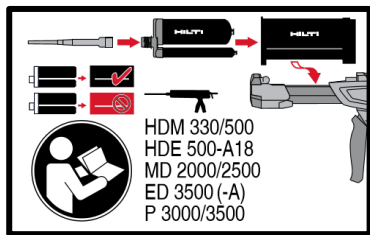

**Injection system preparation.**

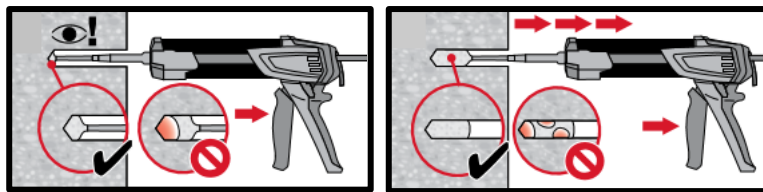

**Injection method for drill hole depth**  
 $h_{ef} \leq 250$  mm.

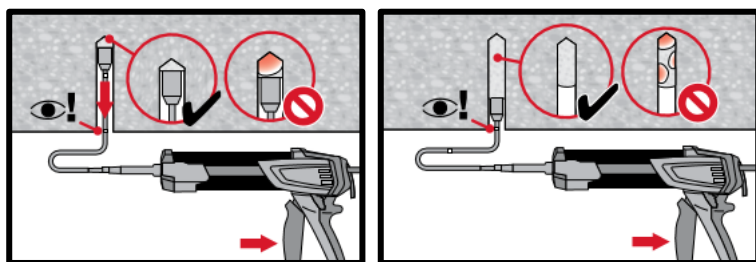

**Injection method for overhead application or installation with embedment depth**  
 $h_{ef} > 250$  mm.



### Setting the element

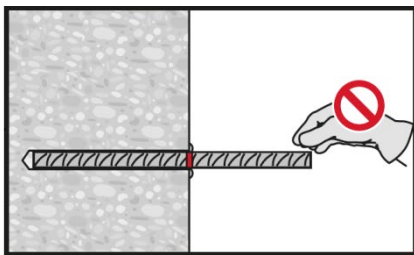
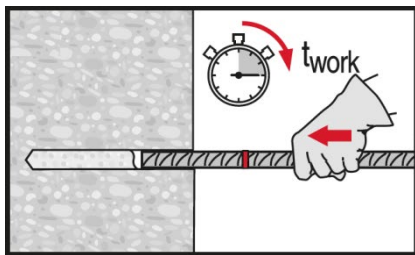

**Setting element**, observe working time " $t_{work}$ ".

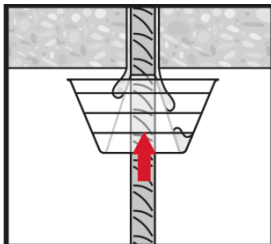
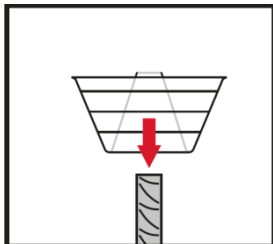
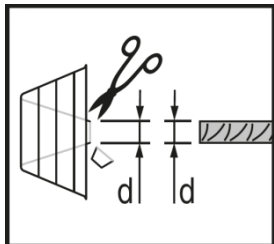

**Setting element** for overhead applications, observe working time " $t_{work}$ ".

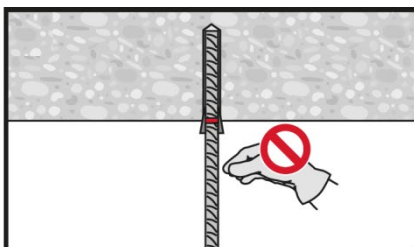
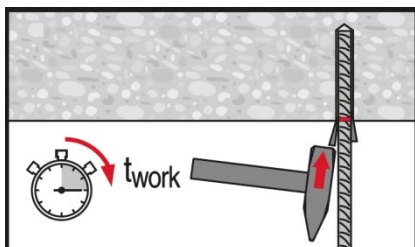

**Loading the anchor:** After required curing time  $t_{cure}$  the anchor can be loaded.

# HIT-HY 110 injection mortar

Rebar design (EN 1992-1) / Rebar elements / Concrete

## Injection mortar system



Hilti HIT-HY 110

500 ml foil pack (also available as 330 ml foil pack)

Rebar ( $\phi 8$ - $\phi 25$ )

## Benefits

- Suitable for concrete C 12/15 to C 50/60
- Suitable for dry and water saturated concrete
- For rebar diameters up to 25 mm
- Non corrosive to rebar elements
- Good loading capacity and fast cure
- Suitable for applications down to -5 °C
- Suitable for embedment depth up to 1500 mm depending on the rebar diameter

## Base material



Concrete (non-cracked)

## Load conditions



Static/quasi-static

## Installation conditions

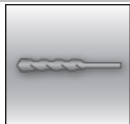

Hammer drilled holes

## Other information



European Technical Assessment



CE conformity

## Approvals / certificates

Description	Authority / Laboratory	No. / date of issue
European technical approval	DIBt, Berlin	ETA-13/1037 / 2014-05-26

a) All data given in this section according to ETA-13/1037, issue 2014-05-26.

## Static and quasi-static loading

Design bond strength in N/mm<sup>2</sup> according to ETA 11/0492 for good bond conditions for hammer drilling and compressed air drilling.

Rebar (mm)	Concrete class								
	C12/15	C16/20	C20/25	C25/30	C30/37	C35/45	C40/50	C45/55	C50/60
8 - 25	1,6	2,0	2,3	2,7	3,0	3,0	3,0	3,4	3,7

For all other bond conditions, multiply the value by 0.7.

## Anchorage length

The minimum anchorage length  $\ell_{b,min}$  and the minimum lap length  $\ell_{0,min}$  according to EN 1992-1-1:2004+AC:2010 ( $\ell_{b,min}$  acc. to Eq. 8.6 and Eq. 8.7 and  $\ell_{0,min}$  acc. to Eq. 8.11) shall be multiplied by a factor according to Table below.

Concrete class	Drilling method	Factor
C12/15 to C25/30	Hammer drilling (HD) and compressed air drilling (CA)	1,0
C30/37		1,1
C35/45 to C40/50		1,2
C45/55 to C50/60		1,3

**Example of pre-calculated values for rebar yield strength  $f_{yk} = 500 \text{ N/mm}^2$ , concrete C25/30 and good bond conditions**

Rebar [mm]	Anchorage length $l_{bd}$ [mm]	Design value $N_{Rd}$ [kN]	Mortar volume [ml]	Anchorage length $l_{bd}$ [mm]	Design value $N_{Rd}$ [kN]	Mortar volume [ml]
<b>All <math>\alpha = 1</math></b>				<b>One of the <math>\alpha = 0.7</math></b>		
8	100 (minimum)	6,8	7,5	100	9,7	8
	170	11,5	13	140	13,6	11
	250	17,0	19	180	17,4	14
	<b>322 (yielding)</b>	<b>21,9</b>	24	<b>225</b>	<b>21,8</b>	17
10	121	10,3	11	121	14,7	11
	220	18,7	20	170	20,6	15
	310	26,3	28	230	27,9	21
	<b>403</b>	<b>34,2</b>	36	<b>282</b>	<b>34,2</b>	26
12	145	14,8	15	145	21,1	15
	260	26,5	27	210	30,5	22
	370	37,7	39	270	39,3	29
	<b>483</b>	<b>49,2</b>	51	<b>338</b>	<b>49,1</b>	36
14	169	20,1	20	169	28,7	20
	300	35,6	36	240	40,7	29
	430	51,1	52	320	54,3	39
	<b>564</b>	<b>67,0</b>	68	<b>395</b>	<b>67,0</b>	48
16	193	26,2	26	193	37,4	26
	340	46,1	46	280	54,3	38
	490	66,5	67	370	71,7	50
	<b>644</b>	<b>87,4</b>	87	<b>451</b>	<b>87,4</b>	61
18	218	33,3	33	218	47,5	33
	310	47,3	47	310	67,6	47
	410	62,6	62	410	89,4	62
	<b>500</b>	<b>76,3</b>	75	<b>500</b>	<b>109,1</b>	75
20	242	41,1	51	242	58,6	51
	330	56,0	70	330	80,0	70
	410	69,6	87	410	99,4	87
	<b>500</b>	<b>84,8</b>	106	<b>500</b>	<b>121,2</b>	106
22	266	49,6	75	266	70,9	75
	340	63,4	96	340	90,6	96
	420	78,4	119	420	112,0	119
	<b>500</b>	<b>93,3</b>	141	<b>500</b>	<b>133,3</b>	141
24	290	59,0	122	290	84,3	122
	360	73,3	152	360	104,7	152
	430	87,5	182	430	125,1	182
	<b>500</b>	<b>101,8</b>	211	<b>500</b>	<b>145,4</b>	211
25	302	64,0	114	302	91,5	114
	370	78,5	139	370	112,1	139
	430	91,2	162	430	130,3	162
	<b>500</b>	<b>106,0</b>	188	<b>500</b>	<b>151,5</b>	188

\* Values corresponding to the minimum anchorage length. The maximum permissible load is valid for "good bond conditions" as described in EN 1992-1-1. For all other conditions multiply by the value by 0,7. The volume of mortar correspond to the formula " $1,2 \cdot (d_0^2 - d_s^2) \cdot \pi \cdot l_b / 4$ " for hammer drilling

**Materials**
**Material quality**

Part	Material
Rebar EN 1992-1-1	Bars and de-coiled rods class B or C with $f_{yk}$ and $k$ according to NDP or NCL of EN 1992-1-1 $f_{uk} = f_{tk} = k \cdot f_{yk}$

**Fitness for use**

Temperature range	Base material temperature	Max. long term base material temperature	Max. short term base material temperature
Temperature range II	- 40 °C to + 80 °C	+ 50 °C	+ 80 °C

**Curing and working time**

Temperature of the base material $T_{BM}$	Working time $t_{work}^{a)}$	Curing time $t_{cure}$
-5 °C to -1 °C	90 min	9 h
0 °C to 4 °C	45 min	4,5 h
5 °C to 9 °C	20 min	2 h
10 °C to 19 °C	6 min	90 min
20 °C to 29 °C	4 min	50 min
30 °C to 40 °C <sup>b)</sup>	2 min	40 min

**Setting information**
**Installation equipment**

Rebar [mm]	φ8	φ10	φ12	φ14	φ16	φ18	φ20	φ22	φ24	φ25
Rotary hammer	TE 2 – TE 40					TE 40 – TE 70				
Other tools	compressed air gun or blow out pump, set of cleaning brushes									

### Drilling and cleaning diameters

Rebar [mm]	Hammer drill (HD)	Compressed air drill (CA)	Brush HIT-RB	Air nozzle HIT-RB
	d <sub>0</sub> [mm]		size [mm]	
φ8	12 / 10 <sup>a)</sup>	-	12 / 10 <sup>a)</sup>	12 / 10 <sup>a)</sup>
φ10	14 / 12 <sup>a)</sup>	-	14 / 12 <sup>a)</sup>	14 / 12 <sup>a)</sup>
φ12	16 / 14 <sup>a)</sup>	-	16 / 14 <sup>a)</sup>	16 / 14 <sup>a)</sup>
	-	17	18	16
φ14	18	17	18	18
	20	-	20	20
φ16	-	20	22	20
	22	22	22	22
φ18	25	-	25	25
	-	26	28	25
φ22	28	28	28	28
φ24	32	32	32	32
φ25	32	32	32	-

a) Maximum installation length l=250 mm.

### Dispensers and corresponding maximum embedment depth $l_{v,max}$

Rebar	Dispenser	
	HDM 330, HDM 500	HDE 500
	$l_{v,max}$ [mm]	$l_{v,max}$ [mm]
φ8 - φ10	700	1000
φ12	700	1150
φ14	700	1300
φ16	700	1500
φ18 - φ25	500	500

## Setting instructions

\*For detailed information on installation see instruction for use given with the package of the product.



### Safety regulations.

Review the Material Safety Data Sheet (MSDS) before use for proper and safe handling! Wear well-fitting protective goggles and protective gloves when working with Hilti HIT-HY 110.

### Drilling

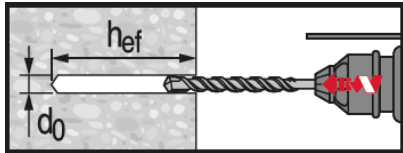

**Hammer drilled hole (HD)**

### Cleaning

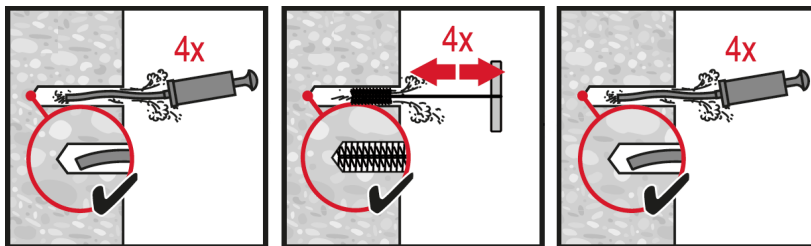

**Manual cleaning (MC)**  
Non-cracked concrete only

for drill diameters  $d_0 \leq 18$  mm and drill hole depth  $h_0 \leq 10 \cdot d$  or  $h_0 \leq 160$ .

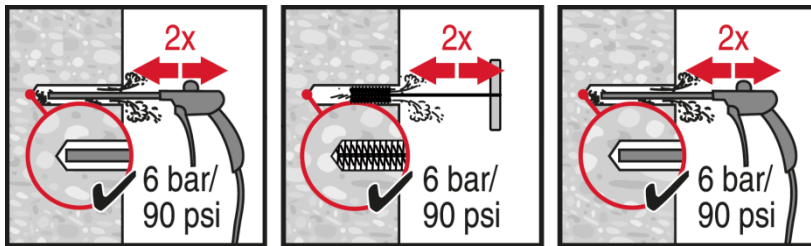

**Compressed air cleaning (CAC)**

for all drill hole diameters  $d_0$  and drill hole depths  $h_0$ .

### Injection system

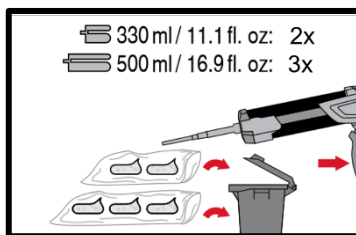
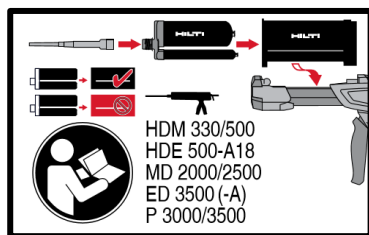

**Injection system preparation.**

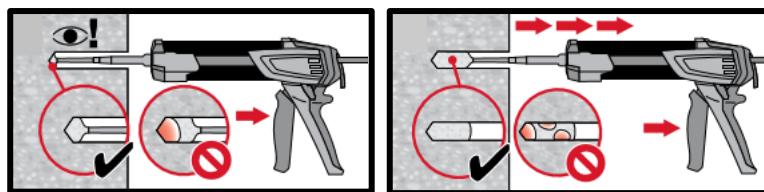

**Injection method for drill hole depth**  
 $h_{ef} \leq 250$  mm.

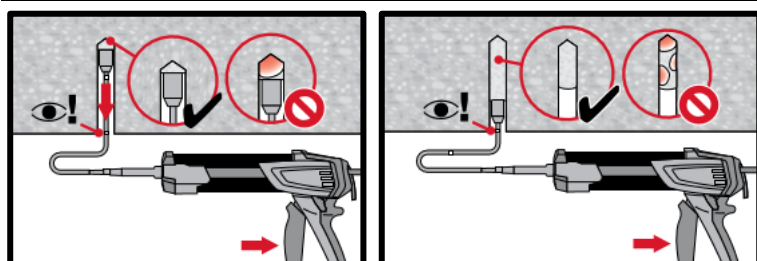

**Injection method for overhead application or installation with embedment depth**  
 $h_{ef} > 250$  mm.

### Setting the element

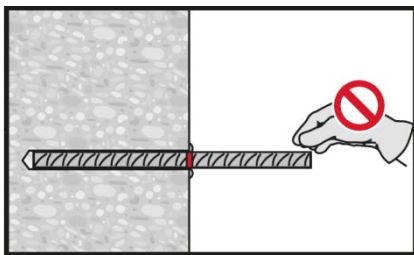
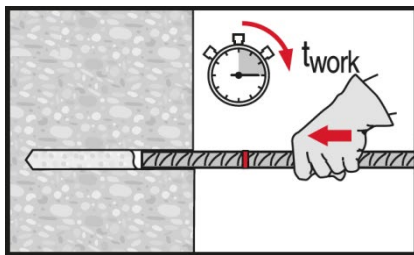

**Setting element**, observe working time " $t_{work}$ ".

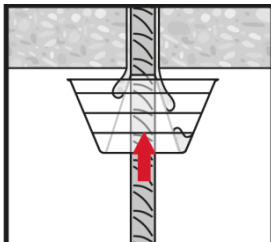
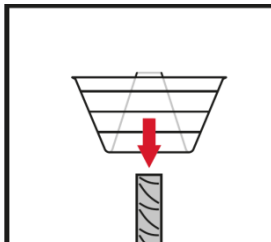
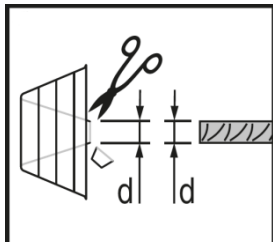

**Setting element** for overhead applications, observe working time " $t_{work}$ ".

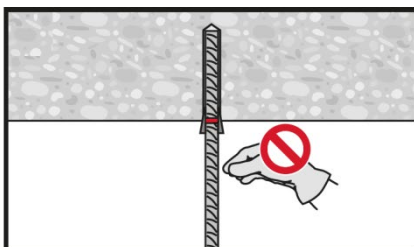
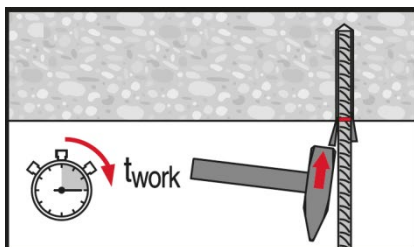

**Loading the anchor:** After required curing time  $t_{cure}$  the anchor can be loaded.



# HIT-HY 100 injection mortar

Anchor design (ETAG 001) / Rods&Sleeves / Concrete

Concrete

Chemical anchors

Mechanical anchors

Plastic/Light duty metal anchors

Insulation anchors

## Injection mortar system



Hilti HIT-HY 100  
330 ml foil pack  
(also available as  
500 ml foil pack)



Anchor rod:  
HIT-V  
HIT-V-F  
HIT-V-R  
HIT-V-HCR  
(M8-M30)



Internally threaded  
sleeve:  
HIS-N  
HIS-RN sleeves  
(M8-M20)

## Benefits

- Suitable for cracked<sup>a)</sup> and non-cracked concrete C 20/25 to C 50/60
- High corrosion<sup>a)</sup> / corrosion resistant
- Suitable for dry and water saturated concrete
- Small edge distance and anchor spacing possible
- In service temperature range up to 80°C short term / 50°C long term

a) Applications only with HIT-V anchor rods

## Base material



Concrete  
(non-cracked)

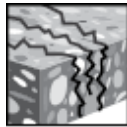

Concrete  
(cracked)<sup>a)</sup>



Dry concrete



Wet  
concrete

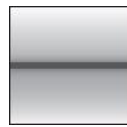

Static/  
quasi-static

## Load conditions

## Installation conditions

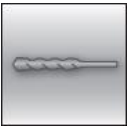

Hammer  
drilling

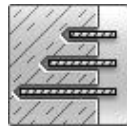

Variable  
embedment  
depth

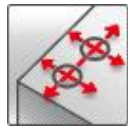

Small edge  
distance and  
spacing

a) Applications only for HIT-V rods.

## Other informations



European  
Technical  
Assessment



CE  
conformity

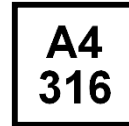

Corrosion  
resistance



High  
corrosion  
resistance<sup>a)</sup>

## Approvals / certificates

Description	Authority / Laboratory	No. / date of issue
European technical assessment <sup>a)</sup>	CSTB, Marne-la-Vallée	ETA-14/0009 / 2014-05-24

a) All data given in this section according to ETA-14/0009 issue 2014-05-24.

## Static and quasi-static loading (for a single anchor)

### All data in this section applies to

- Correct setting (See setting instruction)
- No edge distance and spacing influence
- Steel failure
- Base material thickness, as specified in the table
- One typical embedment depth, as specified in the table
- One anchor material, as specified in the tables
- Concrete C 20/25,  $f_{ck,cube} = 25 \text{ N/mm}^2$
- Temperate range

### Embedment depth and base material thickness

Anchor size		M8	M10	M12	M16	M20	M24	M27	M30
<b>HIT-V</b>									
Typical embedment depth	[mm]	80	90	110	125	170	210	240	270
Base material thickness	[mm]	110	120	140	165	220	270	300	340
<b>HIS-N</b>									
Typical embedment depth	[mm]	90	110	125	170	205	-	-	-
Base material thickness	[mm]	120	150	170	230	270	-	-	-

### Characteristic resistance

Anchor size			M8	M10	M12	M16	M20	M24	M27	M30
<b>Non-cracked concrete</b>										
Tension $N_k$	HIT-V 5.8	[kN]	18,0	29,0	42,0	70,6	111,9	153,7	187,8	216,3
	HIS-N 8.8		25,0	46,0	67,0	95,0	109,0	-	-	-
Shear $V_k$	HIT-V 5.8	[kN]	9,0	15,0	21,0	39,0	61,0	88,0	115,0	140,0
	HIS-N 8.8		13,0	23,0	39,0	59,0	55,0	-	-	-
<b>Cracked concrete</b>										
Tension $N_k$	HIT-V 5.8	[kN]	-	15,6	22,8	34,6	-	-	-	-
Shear $V_k$	HIT-V 5.8	[kN]	-	15,0	21,0	39,0	-	-	-	-

### Design resistance

Anchor size			M8	M10	M12	M16	M20	M24	M27	M30
<b>Non-cracked concrete</b>										
Tension $N_{Rd}$	HIT-V 5.8	[kN]	12,0	19,3	28,0	39,2	62,2	85,4	104,3	120,2
	HIS-N 8.8		17,5	27,8	39,2	52,8	63,9	-	-	-
Shear $V_{Rd}$	HIT-V 5.8	[kN]	7,2	12,0	16,8	31,2	48,8	70,4	92,0	112,0
	HIS-N 8.8		10,4	18,4	26,0	39,3	36,7	-	-	-
<b>Cracked concrete</b>										
Tension $N_{Rd}$	HIT-V 5.8	[kN]	-	8,6	12,7	19,2	-	-	-	-
Shear $V_{Rd}$	HIT-V 5.8	[kN]	-	12,0	16,8	31,2	-	-	-	-

### Recommended loads <sup>a)</sup>

Anchor size			M8	M10	M12	M16	M20	M24	M27	M30
<b>Non-cracked concrete</b>										
Tension $N_{Rec}$	HIT-V 5.8	[kN]	8,6	13,8	20,0	28,0	44,4	61,0	74,5	85,8
	HIS-N 8.8		12,5	19,8	28,0	37,7	45,6	-	-	-
Shear $V_{Rec}$	HIT-V 5.8	[kN]	5,1	8,6	12,0	22,3	34,9	50,3	65,7	80,0
	HIS-N 8.8		7,4	13,1	18,6	28,1	26,2	-	-	-
<b>Cracked concrete</b>										
Tension $N_{Rec}$	HIT-V 5.8	[kN]	-	6,2	9,1	13,7	-	-	-	-
Shear $V_{Rec}$	HIT-V 5.8	[kN]	-	8,6	12,0	22,3	-	-	-	-

a) With overall partial safety factor for action  $\gamma=1,4$ . The partial safety factors for action depend on the type of loading and shall be taken from national regulations.

## Materials

### Mechanical properties for HIT-V

Anchor size		M8	M10	M12	M16	M20	M24	M27	M30	
Nominal tensile strength $f_{uk}$	HIT-V 5.8	500	500	500	500	500	500	500	500	
	HIT-V 8.8	800	800	800	800	800	800	800	800	
	HIT-V-R	700	700	700	700	700	700	500	500	
	HIT-V-HCR	800	800	800	800	800	700	700	700	
Yield strength $f_{yk}$	HIT-V 5.8	400	400	400	400	400	400	400	400	
	HIT-V 8.8	640	640	640	640	640	640	640	640	
	HIT-V-R	450	450	450	450	450	450	210	210	
	HIT-V-HCR	640	640	640	640	640	400	400	400	
Stressed cross-section $A_s$	HIT-V	[mm <sup>2</sup> ]	36,6	58,0	84,3	157	245	353	459	561
Moment of resistance $W$	HIT-V	[mm <sup>3</sup> ]	31,2	62,3	109	277	541	935	1387	1874

### Mechanical properties for HIS-N

Anchor size		M8	M10	M12	M16	M20	
Nominal tensile strength $f_{uk}$	HIS-N	490	490	460	460	460	
	Screw 8.8	800	800	800	800	800	
	HIS-RN	700	700	700	700	700	
	Screw A4 - 70	700	700	700	700	700	
Yield strength $f_{yk}$	HIS-N	410	410	375	375	375	
	Screw 8.8	640	640	640	640	640	
	HIS-RN	350	350	350	350	350	
	Screw A4 - 70	450	450	450	450	450	
Stressed cross-section $A_s$	HIS-(R)N	[mm <sup>2</sup> ]	51,5	108,0	169,1	256,1	237,6
	Screw	[mm <sup>2</sup> ]	36,6	58	84,3	157	245
Moment of resistance $W$	HIS-(R)N	[mm <sup>3</sup> ]	145	430	840	1595	1543
	Screw	[mm <sup>3</sup> ]	31,2	62,3	109	277	541

### Material quality for HIT-V

Part	Material
<b>Zinc coated steel</b>	
Threaded rod, HIT-V 5.8 (F)	Strength class 5.8; Elongation at fracture A5 > 8% ductile Electroplated zinc coated $\geq 5\mu\text{m}$ ; (F) hot dip galvanized $\geq 45\mu\text{m}$
Threaded rod, HIT-V 8.8 (F)	Strength class 8.8; Elongation at fracture A5 > 12% ductile Electroplated zinc coated $\geq 5\mu\text{m}$ ; (F) hot dip galvanized $\geq 45\mu\text{m}$
Washer	Electroplated zinc coated $\geq 5\mu\text{m}$ , hot dip galvanized $\geq 45\mu\text{m}$
Nut	Strength class of nut adapted to strength class of threaded rod. Electroplated zinc coated $\geq 5\mu\text{m}$ , hot dip galvanized $\geq 45\mu\text{m}$
<b>Stainless Steel</b>	
Threaded rod, HIT-V-R	Strength class 70 for $\leq M24$ and strength class 50 for $> M24$ ; Elongation at fracture A5 > 8% ductile Stainless steel 1.4401; 1.4404; 1.4578; 1.4571; 1.4439; 1.4362
Washer	Stainless steel 1.4401, 1.4404, 1.4578, 1.4571, 1.4439, 1.4362 EN 10088-1:2014
Nut	Stainless steel 1.4401, 1.4404, 1.4578, 1.4571, 1.4439, 1.4362 EN 10088-1:2014

### Material quality for HIT-V

Part	Material
<b>High corrosion resistant steel</b>	
Threaded rod, HIT-V-HCR	Strength class 80 for $\leq M20$ and class 70 for $> M20$ , Elongation at fracture A5 $> 8\%$ ductile High corrosion resistance steel 1.4529; 1.4565;
Washer	High corrosion resistant steel 1.4529, 1.4565 EN 10088-1:2014
Nut	High corrosion resistant steel 1.4529, 1.4565 EN 10088-1:2014

### Material quality for HIS-N

Part	Material
HIS-N	Internal threaded sleeve C-steel 1.0718 Steel galvanized $\geq 5 \mu\text{m}$
	Screw 8.8 Strength class 8.8, A5 $> 8\%$ Ductile Steel galvanized $\geq 5 \mu\text{m}$
HIS-RN	Internal threaded sleeve Stainless steel 1.4401, 1.4571
	Screw 70 Strength class 70, A5 $> 8\%$ Ductile Stainless steel 1.4401; 1.4404, 1.4578; 1.4571; 1.4439; 1.4362

### Setting information

#### Installation temperature range:

-10°C to +40°C

#### In service temperature range

Hilti HIT-HY 100 injection mortar may be applied in the temperature ranges given below. An elevated base material temperature may lead to a reduction of the design bond resistance.

Temperature range	Base material temperature	Max. long term base material temperature	Max. short term base material temperature
Temperature range I	-40 °C to + 40 °C	+ 24 °C	+ 40 °C
Temperature range II	-40 °C to + 80 °C	+ 50 °C	+ 80 °C

#### Max. short term base material temperature

Short term elevated base material temperatures are those that occur over brief intervals, e.g. as a result of diurnal cycling.

#### Max. long term base material temperature

Long term elevated base material temperatures are roughly constant over significant periods of time.

### Working time and curing time

Temperature of the base material	Maximum working time $t_{\text{work}}$	Minimum curing time $t_{\text{cure}}$
$-10 \text{ °C} < T_{\text{BM}} \leq -5 \text{ °C}^{\text{a)}$	180 min	12 h
$-5 \text{ °C} < T_{\text{BM}} \leq 0 \text{ °C}$	40 min	4 h
$0 \text{ °C} < T_{\text{BM}} \leq 5 \text{ °C}$	20 min	2 h
$5 \text{ °C} < T_{\text{BM}} \leq 20 \text{ °C}$	8 min	1 h
$20 \text{ °C} < T_{\text{BM}} \leq 30 \text{ °C}$	5 min	30 min
$30 \text{ °C} < T_{\text{BM}} \leq 40 \text{ °C}$	2 min	30 min

The curing time data are valid for dry base material only. In wet base material the curing times must be doubled.

a) The foil pack temperature must be between 20°C and 25°C.

### Setting details for HIT-V

Anchor size		M8	M10	M12	M16	M20	M24	M27	M30
Nominal diameter of drill bit	$d_0$ [mm]	10	12	14	18	22	28	30	35
Diameter of element	$d$ [mm]	8	10	12	16	20	24	27	30
Effective anchorage and drill hole depth <sup>b)</sup>	$\frac{h_{ef,min}}{h_{ef,max}}$ [mm]	60	60	70	80	90	100	110	120
	$h_{ef,max}$ [mm]	160	200	240	320	400	480	540	600
Minimum base material thickness <sup>c)</sup>	$h_{min}$ [mm]	$h_{ef} + 30 \geq 100$ mm			$h_{ef} + 2 d_0$				
Diameter of clearance hole in the fixture	$d_f$ [mm]	9	12	14	18	22	26	30	33
Min. spacing	$s_{min}$ [mm]	40	50	60	80	100	120	135	150
Min. edge distance	$c_{min}$ [mm]	40	50	60	80	100	120	135	150
Critical spacing for splitting failure	$s_{cr,sp}$ [mm]	$2 C_{cr,sp}$							
Critical edge distance for splitting failure <sup>a)</sup>	$C_{cr,sp}$ [mm]	$1,0 \cdot h_{ef}$		for $h / h_{ef} \geq 2,0$					
		$4,6 h_{ef} - 1,8 h$		for $2,0 > h / h_{ef} > 1,3$					
		$2,26 h_{ef}$		for $h / h_{ef} \leq 1,3$					
Critical spacing for concrete cone failure	$s_{cr,N}$ [mm]	$2 C_{cr,N}$							
Critical edge distance for concrete cone failure <sup>d)</sup>	$C_{cr,N}$ [mm]	$1,5 h_{ef}$							
Torque moment <sup>e)</sup>	$T_{max}$ [Nm]	10	20	40	80	150	200	270	300

For spacing (edge distance) smaller than critical spacing (critical edge distance) the design loads have to be reduced.

- a) both given values for drill bit diameter can be used
- b)  $h_{ef,min} \leq h_{ef} \leq h_{ef,max}$  ( $h_{ef}$ : embedment depth)
- c)  $h$ : base material thickness ( $h \geq h_{min}$ )
- d) The critical edge distance for concrete cone failure depends on the embedment depth  $h_{ef}$  and the design bond resistance. The simplified formula given in this table is on the save side.
- e) Maximum recommended torque moment to avoid splitting failure during installation with minimum spacing and/or edge distance.

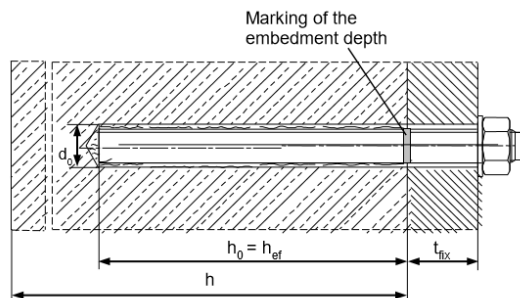
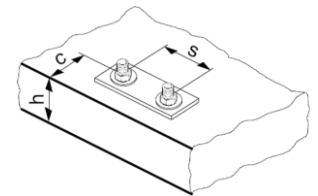

### Setting details for HIS-N

Anchor size	M8	M10	M12	M16	M20
Nominal diameter of drill bit $d_0$ [mm]	14	18	22	28	32
Diameter of element $d$ [mm]	12,5	16,5	20,5	25,4	27,6
Effective anchorage and drill hole depth $h_{ef}$ [mm]	90	110	125	170	205
Minimum base material thickness $h_{min}$ [mm]	120	150	170	230	270
Diameter of clearance hole in the fixture $d_f$ [mm]	9	12	14	18	22
Thread engagement length min-max $h_s$ [mm]	8-20	10-25	12-30	16-40	20-50
Min. spacing $s_{min}$ [mm]	40	45	55	65	90
Min. edge distance $c_{min}$ [mm]	40	45	55	65	90
Critical spacing for splitting failure $s_{cr,sp}$ [mm]	$2 C_{cr,sp}$				
Critical edge distance for splitting failure <sup>a)</sup> $c_{cr,sp}$ [mm]	$1,0 \cdot h_{ef}$		for $h / h_{ef} \geq 2,0$		
	$4,6 h_{ef} - 1,8 h$		for $2,0 > h / h_{ef} > 1,3$		
	$2,26 h_{ef}$		for $h / h_{ef} \leq 1,3$		
Critical spacing for concrete cone failure $s_{cr,N}$ [mm]	$2 C_{cr,N}$				
Critical edge distance for concrete cone failure <sup>b)</sup> $c_{cr,N}$ [mm]	$1,5 h_{ef}$				
Torque moment <sup>c)</sup> $T_{max}$ [Nm]	10	20	40	80	150

For spacing (edge distance) smaller than critical spacing (critical edge distance) the design loads have to be reduced.



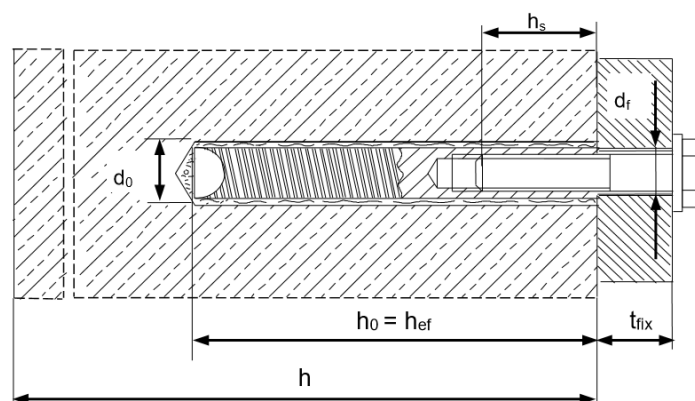
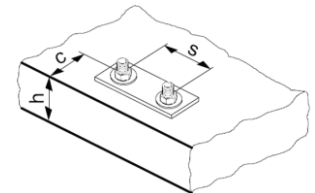

- f) both given values for drill bit diameter can be used
- g)  $h_{ef,min} \leq h_{ef} \leq h_{ef,max}$  ( $h_{ef}$ : embedment depth)
- h)  $h$ : base material thickness ( $h \geq h_{min}$ )
- i) The critical edge distance for concrete cone failure depends on the embedment depth  $h_{ef}$  and the design bond resistance. The simplified formula given in this table is on the save side.
- j) Maximum recommended torque moment to avoid splitting failure during installation with minimum spacing and/or edge distance.



### Installation equipment

Anchor size	M8	M10	M12	M16	M20	M24	M27	M30
Rotary hammer	HIT-V			TE 2 – TE 30		TE 40 – TE 80		
	HIS-N			TE 2 – TE 30		TE 40 – TE 80		-
Other tools	compressed air gun or blow out pump set of cleaning brushes, dispenser							

## Drilling and cleaning parameters

HIT-V	HIS-N	Hammer drill	Brush HIT-RB	Piston plug HIT-SZ
		$d_0$ [mm]	size [mm]	
				
<b>M8</b>	-	10	10	-
<b>M10</b>	-	12	12	12
<b>M12</b>	<b>M8</b>	14	14	14
<b>M16</b>	<b>M10</b>	18	18	18
-	<b>M12</b>	22	22	22
<b>M20</b>	-	24	24	24
<b>M24</b>	<b>M16</b>	28	28	28
<b>M27</b>	-	30	30	30
-	<b>M20</b>	32	32	32
<b>M30</b>	-	35	35	35

## Setting instructions

\*For detailed information on installation see instruction for use given with the package of the product.



### Safety regulations.

Review the Material Safety Data Sheet (MSDS) before use for proper and safe handling! Wear well-fitting protective goggles and protective gloves when working with Hilti HIT-HY 100.

## Drilling

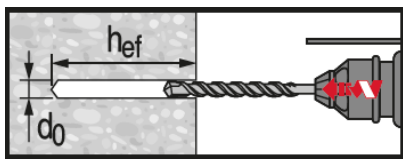

Hammer drilled hole (HD)

## Cleaning

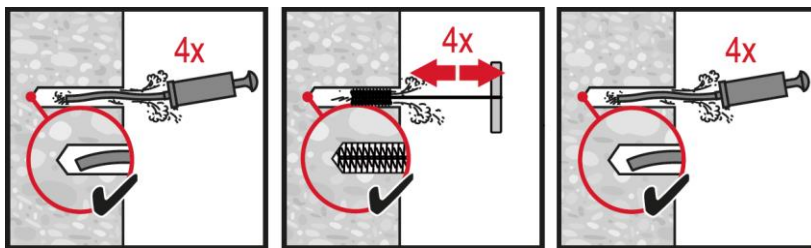

### Manual cleaning (MC)

for drill diameters  $d_0 \leq 18$  mm and drill hole depth  $h_0 \leq 10 \cdot d_0$ .

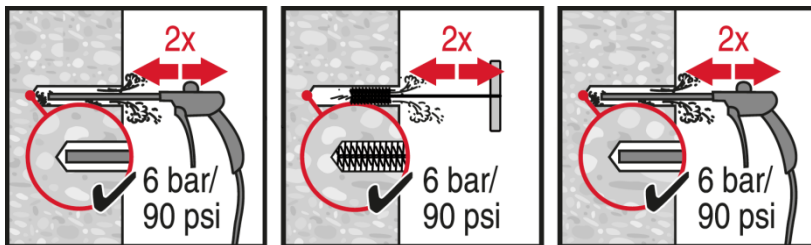

### Compressed air cleaning (CAC)

for all drill hole diameters  $d_0$  and drill hole depths  $h_0$ .

Concrete  
Chemical anchors  
Mechanical anchors  
Plastic/Light duty metal anchors  
Insulation anchors



## Injection system

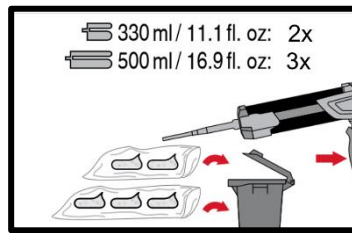
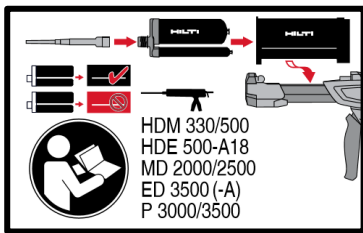

**Injection system preparation.**

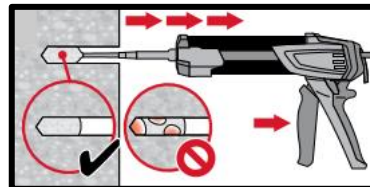
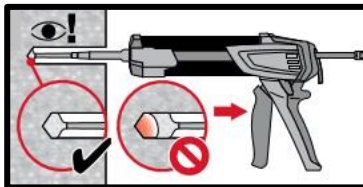

**Injection method for drill hole depth**  
 $h_{ef} \leq 250 \text{ mm.}$

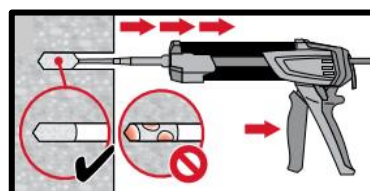
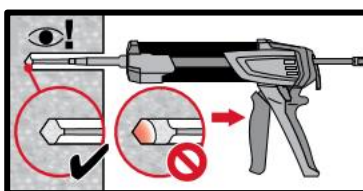

**Injection method for application with**  
embedment depth  $h_{ef} > 250 \text{ mm.}$

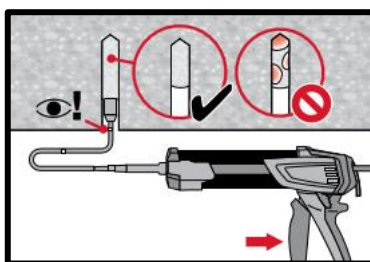
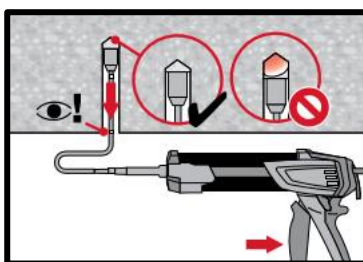

**Injection method for overhead**  
application and/or installation with  
embedment depth  $h_{ef} > 250 \text{ mm.}$

## Setting the element

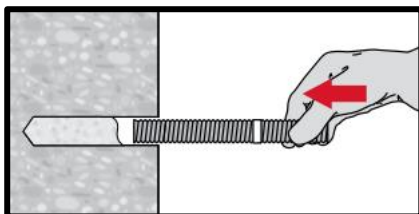

**Setting element**, observe working time  
“ $t_{work}$ ”,

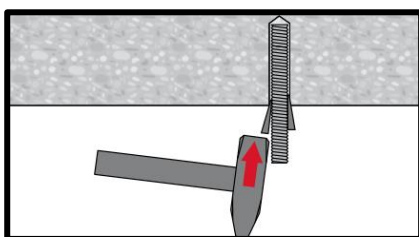

**Setting element for overhead**  
applications, observe working time “ $t_{work}$ ”,

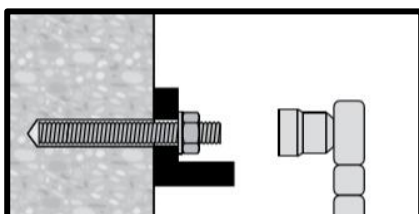

**Loading the anchor:** After required  
curing time  $t_{cure}$  the anchor can be  
loaded.

# HIT-HY 100 injection mortar

Anchor design (ETAG 001) / Rebar elements / Concrete

## Injection mortar system



Hilti HIT-HY 100  
330 ml foil pack  
(also available as  
500 ml foil pack)



Rebar B500 B  
( $\phi 8$ - $\phi 25$ )

## Benefits

- Suitable for cracked and non-cracked concrete C 20/25 to C 50/60
- Suitable for dry and water saturated concrete
- Small edge distance and anchor spacing possible
- In service temperature range up to 80°C short term / 50°C long term

## Base material



Concrete (non-cracked)

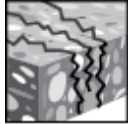

Concrete (cracked)



Dry concrete



Wet concrete

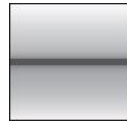

Static/  
quasi-static

## Load conditions

## Installation conditions



Hammer drilling

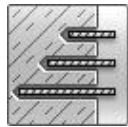

Variable embedment depth

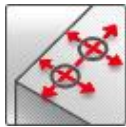

Small edge distance and spacing

## Other informations



European Technical Assessment



CE conformity

## Approvals / certificates

Description	Authority / Laboratory	No. / date of issue
European technical assessment <sup>a)</sup>	CSTB, Marne-la-Vallée	ETA-14/0009 / 2014-05-24

b) All data given in this section according to ETA-14/0009 issue 2014-05-24.

## Static and quasi-static loading (for a single anchor)

### All data in this section applies to

- Correct setting (See setting instruction)
- No edge distance and spacing influence
- Steel failure
- Base material thickness, as specified in the table
- One typical embedment depth, as specified in the table
- Anchor material: rebar B500 B
- Concrete C 20/25,  $f_{ck,cube} = 25 \text{ N/mm}^2$
- Temperature range I  
(min. base material temperature  $-40^\circ\text{C}$ , max. long term/short term base material temperature:  $+24^\circ\text{C}/40^\circ\text{C}$ )

### Embedment depth <sup>a)</sup> and base material thickness for static and quasi-static loading data

Anchor- size	$\phi 8$	$\phi 10$	$\phi 12$	$\phi 14$	$\phi 16$	$\phi 20$	$\phi 25$
Typical embedment depth [mm]	80	90	110	125	145	170	210
Base material thickness [mm]	110	120	140	165	185	220	274

a) The allowed range of embedment depth is shown in the setting details. The corresponding load values can be calculated according to the simplified design method.

### Characteristic resistance

Anchor- size	$\phi 8$	$\phi 10$	$\phi 12$	$\phi 14$	$\phi 16$	$\phi 20$	$\phi 25$
<b>Non-cracked concrete</b>							
Tensile $N_{Rk}$ [kN]	19,1	26,9	39,4	52,2	69,2	101,5	153,7
Shear $V_{Rk}$ [kN]	14,0	22,0	31,0	42,0	55,0	86,0	135,0
<b>Cracked concrete</b>							
Tensile $N_{Rk}$ [kN]	-	15,6	22,8	30,2	29,2	-	-
Shear $V_{Rk}$ [kN]	-	22,0	31,0	42,0	55,0	-	-

### Design resistance

Anchor- size	$\phi 8$	$\phi 10$	$\phi 12$	$\phi 14$	$\phi 16$	$\phi 20$	$\phi 25$
<b>Non-cracked concrete</b>							
Tensile $N_{Rd}$ [kN]	10,6	14,9	21,9	29,0	38,5	56,4	85,4
Shear $V_{Rd}$ [kN]	9,3	14,7	20,7	28,0	36,7	57,3	90,0
<b>Cracked concrete</b>							
Tensile $N_{Rd}$ [kN]	-	8,6	12,7	16,8	16,2	-	-
Shear $V_{Rd}$ [kN]	-	14,7	20,7	28,0	36,7	-	-

### Recommended loads <sup>a)</sup>

Anchor- size	$\phi 8$	$\phi 10$	$\phi 12$	$\phi 14$	$\phi 16$	$\phi 20$	$\phi 25$
<b>Non-cracked concrete</b>							
Tensile $N_{Rec}$ [kN]	7,6	10,7	15,6	20,7	27,5	40,3	61,0
Shear $V_{Rec}$ [kN]	6,7	10,5	14,8	20,0	26,2	41,0	64,3
<b>Cracked concrete</b>							
Tensile $N_{Rec}$ [kN]	-	6,2	9,1	12,0	11,6	-	-
Shear $V_{Rec}$ [kN]	-	10,5	14,8	20,0	26,2	-	-

a) With overall partial safety factor for action  $\gamma = 1,4$ . The partial safety factors for action depend on the type of loading and shall be taken from national regulations.

## Materials

### Mechanical properties

Anchor size		φ8	φ10	φ12	φ14	φ16	φ20	φ25
Nominal tensile strength $f_{uk}$	[N/mm <sup>2</sup> ]	550	550	550	550	550	550	550
Yield strength $f_{yk}$	[N/mm <sup>2</sup> ]	500	500	500	500	500	500	500
Stressed cross-section $A_s$	[mm <sup>2</sup> ]	50,3	78,5	113,1	153,9	201,1	314,2	490,9
Moment of resistance $W$	[mm <sup>3</sup> ]	50,3	98,2	169,6	269,4	402,1	785,4	1534

### Material quality

Part	Material
Rebar B500 B	EN 1992-1-1:2004 and AC:2010, Annex C Bars and de-coiled rods Class B or C with $f_{yk}$ and $k$ according to NDP or NCL of EN 1992-1-1/NA:2013

### Setting information

**Installation temperature range:**  
-10°C to +40°C

#### In service temperature range

Hilti HIT-HY 100 injection mortar may be applied in the temperature ranges given below. An elevated base material temperature may lead to a reduction of the design bond resistance.

Temperature range	Base material temperature	Max. long term base material temperature	Max. short term base material temperature
Temperature range I	-40 °C to + 40 °C	+ 24 °C	+ 40 °C
Temperature range II	-40 °C to + 80 °C	+ 50 °C	+ 80 °C

#### Max. short term base material temperature

Short term elevated base material temperatures are those that occur over brief intervals, e.g. as a result of diurnal cycling.

#### Max. long term base material temperature

Long term elevated base material temperatures are roughly constant over significant periods of time.

### Working time and curing time

Temperature of the base material	Maximum working time $t_{work}$	Minimum curing time $t_{cure}$
-10 °C < $T_{BM}$ ≤ -5 °C <sup>a)</sup>	180 min	12 h
-5 °C < $T_{BM}$ ≤ 0 °C	40 min	4 h
0 °C < $T_{BM}$ ≤ 5 °C	20 min	2 h
5 °C < $T_{BM}$ ≤ 20 °C	8 min	1 h
20 °C < $T_{BM}$ ≤ 30 °C	5 min	30 min
30 °C < $T_{BM}$ ≤ 40 °C	2 min	30 min

The curing time data are valid for dry base material only. In wet base material the curing times must be doubled.

b) The foil pack temperature must be between 20°C and 25°C.

### Setting details

Anchor size		φ8	φ10	φ12	φ14	φ16	φ20	φ25
Nominal diameter of drill bit	$d_0$ [mm]	12	14	16	18	20	25	32
Effective anchorage and drill hole depth range	$h_{ef,min}$ [mm]	60	60	70	80	80	90	100
	$h_{ef,max}$ [mm]	160	200	240	280	320	400	500
Minimum base material thickness	$h_{min}$ [mm]	$h_{ef} + 30$ mm			$h_{ef} + 2 d_0$			
Min. spacing	$s_{min}$ [mm]	40	50	60	70	80	100	125
Min. edge distance	$c_{min}$ [mm]	40	50	60	70	80	100	125
Critical spacing for splitting failure	$s_{cr,sp}$ [mm]	$2 c_{cr,sp}$						
Critical edge distance for splitting failure <sup>a)</sup>	$c_{cr,sp}$ [mm]	$1,0 \cdot h_{ef}$		for $h / h_{ef} \geq 2,0$				
		$4,6 h_{ef} - 1,8 h$		for $2,0 > h / h_{ef} > 1,3$				
		$2,26 h_{ef}$		for $h / h_{ef} \leq 1,3$				
Critical spacing for concrete cone failure	$s_{cr,N}$ [mm]	$2 c_{cr,N}$						
Critical edge distance for concrete cone failure <sup>b)</sup>	$c_{cr,N}$ [mm]	$1,5 h_{ef}$						

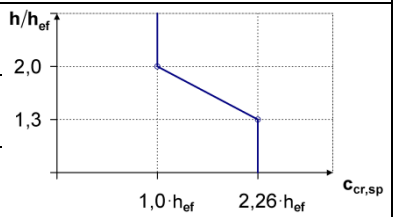

For spacing (edge distance) smaller than critical spacing (critical edge distance) the design loads have to be reduced.

- a)  $h$ : base material thickness ( $h \geq h_{min}$ ),  $h_{ef}$ : embedment depth
- b) The critical edge distance for concrete cone failure depends on the embedment depth  $h_{ef}$  and the design bond resistance. The simplified formula given in this table is on the same side.

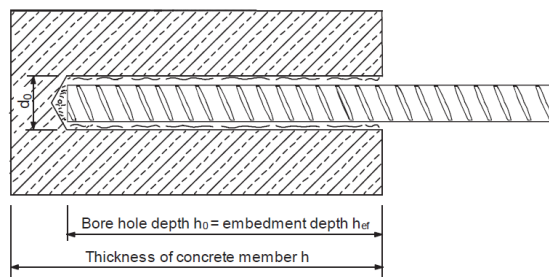
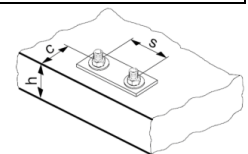

### Installation equipment

Anchor size	φ8	φ10	φ12	φ14	φ16	φ20	φ25
Rotary hammer	TE 2 – TE 30					TE 40 – TE 70	
Other tools	compressed air gun or blow out pump set of cleaning brushes, dispenser						

## Drilling and cleaning parameters

Rebar	Hammer drilling (HD)	Brush HIT-RB	Piston plug HIT-SZ
	$d_0$ [mm]	size [mm]	
$\phi 8$	10 / 12 <sup>a)</sup>	10 / 12 <sup>a)</sup>	- / 12
$\phi 10$	12 / 14 <sup>a)</sup>	12 / 14 <sup>a)</sup>	12 / 14 <sup>a)</sup>
$\phi 12$	14 / 16 <sup>a)</sup>	14 / 16 <sup>a)</sup>	14 / 16 <sup>a)</sup>
$\phi 14$	18	18	18
$\phi 16$	20	20	20
$\phi 20$	25	25	25
$\phi 25$	32	32	32

a) Each of the two given values can be used

## Setting instructions

\*For detailed information on installation see instruction for use given with the package of the product.



### Safety regulations.

Review the Material Safety Data Sheet (MSDS) before use for proper and safe handling! Wear well-fitting protective goggles and protective gloves when working with Hilti HIT-HY 100.

## Drilling

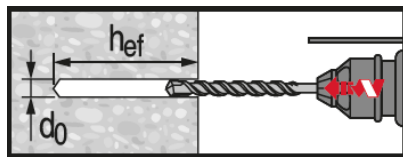

Hammer drilled hole (HD)

## Cleaning

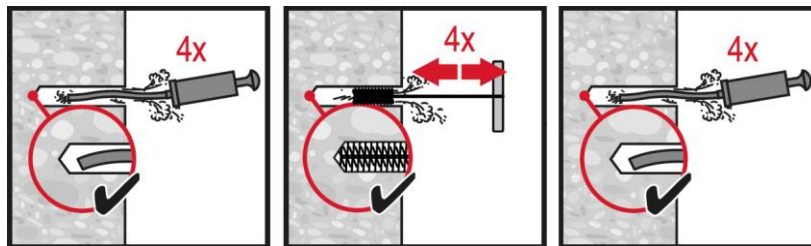

### Manual cleaning (MC)

for drill diameters  $d_0 \leq 18$  mm and drill hole depth  $h_0 \leq 10 \cdot d_0$ .

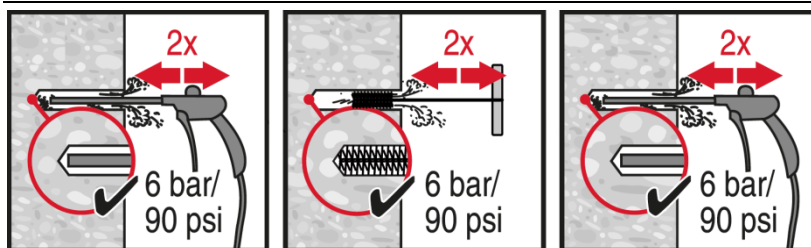

### Compressed air cleaning (CAC)

for all drill hole diameters  $d_0$  and drill hole depths  $h_0$ .

## Injection system

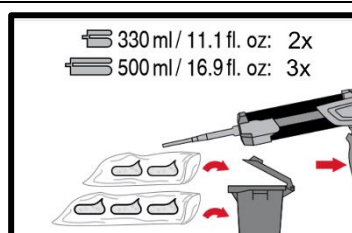
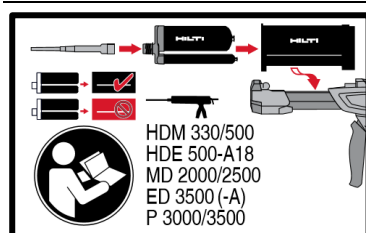

Injection system preparation.



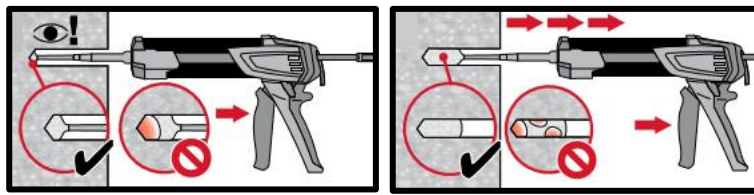

**Injection method** for drill hole depth  $h_{ef} \leq 250$  mm.

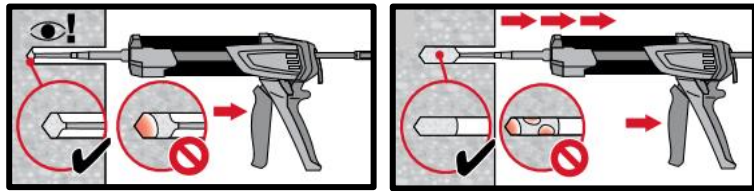

**Injection method** for application with embedment depth  $h_{ef} > 250$  mm.

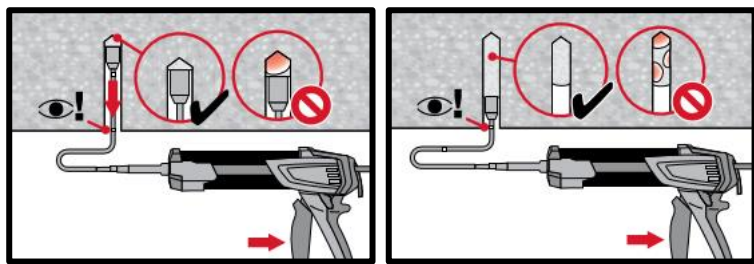

**Injection method** for overhead application and/or installation with embedment depth  $h_{ef} > 250$  mm.

**Setting the element**

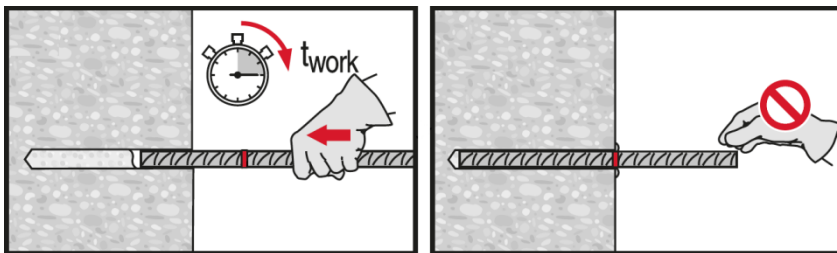

**Setting element**, observe working time " $t_{work}$ ".

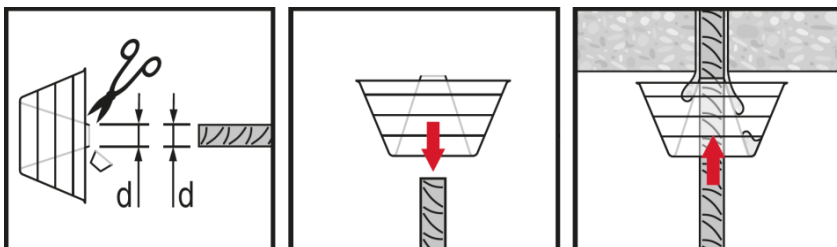

**Setting element** for overhead applications, observe working time " $t_{work}$ ".

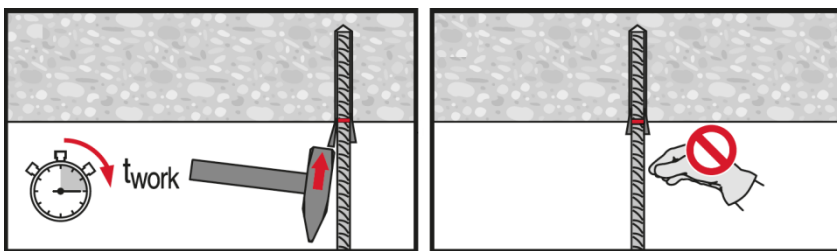

**Loading the anchor:** After required curing time  $t_{cure}$  the anchor can be loaded.





# HIT-HY 100 injection mortar

Rebar design (EN 1992-1) / Rebar elements / Concrete

Concrete  
Chemical anchors

Mechanical anchors

Plastic/Light duty metal anchors

Insulation anchors

## Injection mortar system



Hilti HIT-HY 100  
500 ml foil pack  
(also available  
as 330 ml  
foil pack)



Rebar  
( $\phi 8$ - $\phi 25$ )

## Benefits

- Suitable for concrete C 12/15 to C 50/60
- High loading capacity and fast cure
- Suitable for dry and water saturated concrete
- For rebar diameters up to 25 mm
- Non corrosive to rebar elements
- Suitable for applications down to -10 °C.
- Suitable for embedment depth up to 700 mm depending on the rebar diameter

## Base material



Concrete  
(non-cracked)

## Load conditions



Static/  
quasi-static



Fire  
resistance

## Installation conditions

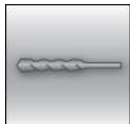

Hammer  
drilled holes

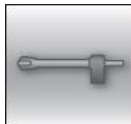

Hollow drill-  
bit drilling

## Other information



European  
Technical  
Assessment



CE  
conformity

**SGK**

Corrosion  
tested

## Approvals / certificates

Description	Authority / Laboratory	No. / date of issue
European technical Approval <sup>a)</sup>	DIBt, Berlin	ETA-14/0001 / 2014-02-12
Assesment	DIBt, Berlin	I 26.1-1.21.8-22/14

a) All data given in this section according to ETA-14/0001, issue 2014-02-12.

## Static and quasi-static loading

Design bond strength in N/mm<sup>2</sup> according to ETA 11/0492 for good bond conditions for hammer drilling and compressed air drilling.

Rebar (mm)	Concrete class								
	C12/15	C16/20	C20/25	C25/30	C30/37	C35/45	C40/50	C45/55	C50/60
8 – 24	1,6	2,0	2,3	2,7	3,0	3,4	3,4	3,4	3,7
25	1,6	2,0	2,3	2,7	3,0	3,4	3,7	3,7	3,7

For all other bond conditions, multiply the value by 0.7.

### Anchorage length

The minimum anchorage length  $\ell_{b,min}$  and the minimum lap length  $\ell_{0,min}$  according to EN 1992-1-1:2004+AC:2010 ( $\ell_{b,min}$  acc. to Eq. 8.6 and Eq. 8.7 and  $\ell_{0,min}$  acc. to Eq. 8.11) shall be multiplied by a factor according to Table below.

Concrete class	Drilling method	Factor
C12/15 to C50/60	Hammer and compressed air drilling	1,5

Example of pre-calculated values for rebar yield strength  $f_{yk} = 500 \text{ N/mm}^2$ , concrete C25/30 and good bond conditions.

Rebar [mm]	Anchorage length $\ell_{bd}$ [mm]	Design value $N_{Rd}$ [kN]	Mortar volume [ml]	Anchorage length $\ell_{bd}$ [mm]	Design value $N_{Rd}$ [kN]	Mortar volume [ml]
	All $\alpha = 1$				One of the $\alpha = 0.7$	
8	150	10,2	11	150	14,5	11
	210	14,3	16	180	17,4	14
	260	17,6	20	200	19,4	15
	<b>322</b>	<b>21,9</b>	24	<b>226</b>	<b>21,9</b>	17
10	181	15,4	16	181	21,9	16
	260	22,1	24	210	25,4	19
	330	28,0	30	250	30,3	23
	<b>403</b>	<b>34,2</b>	36	<b>281</b>	<b>34,1</b>	25
12	218	22,2	23	218	31,7	23
	310	31,6	33	260	37,8	27
	390	39,7	41	300	43,6	32
	<b>483</b>	<b>49,2</b>	51	<b>338</b>	<b>49,1</b>	36
14	254	30,2	31	254	43,1	31
	360	42,8	43	300	50,9	36
	460	54,6	55	350	59,4	42
	<b>564</b>	<b>67,0</b>	68	<b>394</b>	<b>66,8</b>	48
16	290	39,4	39	290	56,2	39
	410	55,6	56	340	65,9	46
	530	71,9	72	400	77,6	54
	<b>644</b>	<b>87,4</b>	87	<b>451</b>	<b>87,4</b>	61
18	326	49,8	49	326	71,1	49
	380	58,0	57	380	82,9	57
	440	67,2	66	440	96,0	66
	<b>500</b>	<b>76,3</b>	75	<b>500</b>	<b>109,1</b>	75
20	363	61,6	77	363	88,0	77
	410	69,6	87	410	99,4	87
	450	76,3	95	450	109,1	95
	<b>500</b>	<b>84,8</b>	106	<b>500</b>	<b>121,2</b>	106

Example of pre-calculated values for rebar yield strength  $f_{yk} = 500 \text{ N/mm}^2$ , concrete C25/30 and good bond conditions.

Rebar	Anchorage length $l_{bd}$	Design value $N_{Rd}$	Mortar volume	Anchorage length $l_{bd}$	Design value $N_{Rd}$	Mortar volume
[mm]	[mm]	[kN]	[ml]	[mm]	[kN]	[ml]
<b>All <math>\alpha = 1</math></b>				<b>One of the <math>\alpha = 0.7</math></b>		
22	399	74,5	113	399	106,4	113
	430	80,2	122	430	114,6	122
	470	87,7	133	470	125,3	133
	<b>500</b>	<b>93,3</b>	141	<b>500</b>	<b>133,3</b>	141
24	435	88,6	184	435	126,5	184
	460	93,6	194	460	133,8	194
	480	97,7	203	480	139,6	203
	<b>500</b>	<b>101,8</b>	211	<b>500</b>	<b>145,4</b>	211
25	453	96,1	170	453	137,2	170
	470	99,7	177	470	142,4	177
	480	101,8	181	480	145,4	181
	<b>500</b>	<b>106,0</b>	188	<b>500</b>	<b>151,5</b>	188

\* Values corresponding to the minimum anchorage length. The maximum permissible load is valid for "good bond conditions" as described in EN 1992-1-1. For all other conditions multiply by the value by 0,7. The volume of mortar correspond to the formula " $1,2 \cdot (d_0^2 - d_s^2) \cdot \pi \cdot l_b / 4$ " for hammer drilling

### Fire loading: according to DIBt Z-21.8-2024

#### a) Fire situation "anchorage"

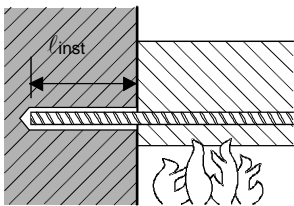

Maximum force in rebar in conjunction with HIT-HY 100 as a function of embedment depth for the fire resistance classes F30 to F180 (yield strength  $f_{yk} = 500 \text{ N/mm}^2$ ) according to EC2.

Bar $\varnothing$	Max. $F_{s,T}$	$l_{inst}$	Fire resistance of bar in [kN]				
			[mm]	R30	R60	R90	R120
8	16,19	80	3,0	0,7	0,2	0,0	0,0
		120	7,0	2,2	1,3	0,7	0,2
		170	16,2	10,2	9,2	4,0	1,7
		210		16,2	11,0	7,5	
		230	14,5		10,9		
		250	14,5		14,5		
		300	16,2	16,2			
10	25,29	100	6,1	2,0	1,0	0,4	0,0
		150	19,3	9,3	7,1	2,2	1,0
		190	25,3	18,0	15,9	9,3	4,9
		230		25,3	24,7	18,1	13,7
		260	24,7		20,3		
		280	25,3		24,7		
		320	25,3	25,3			
12	36,42	120	15,3	6,0	1,9	1,1	0,3
		180	31,0	19,0	17,8	8,5	7,0
		220	36,4	29,6	27,0	19,1	13,8
		260		36,4	29,7	24,4	
		280	35,0		29,6		
		300	36,4		34,9		
		340	36,4	36,4			

Bar Ø [mm]	Max. F <sub>s,T</sub> [kN]	l <sub>inst</sub> [mm]	Fire resistance of bar in [kN]						
			R30	R60	R90	R120	R180		
14	49,58	140	24,0	9,9	6,9	2,6	1,0		
		210	45,0	31,4	28,5	25,7	13,0		
		240	49,6	49,6	49,6	40,6	37,7	32,8	22,3
		280				40,7	34,6		
		300				44,7	40,7		
		330	49,6	49,6	49,6	49,6	48,1		
		360					49,6		
16	64,75	160	34,5	18,4	14,9	4,4	2,3		
		240	62,6	46,4	43,0	37,7	25,5		
		260	64,8	53,5	50,0	44,7	32,5		
		300		64,8	57,0	51,7	49,6		
		330			64,8	61,3	57,2		
		360				64,8	62,7		
		400					64,8		
20	101,18	200	60,7	40,0	36,3	29,3	14,3		
		250	78,3	62,5	58,3	51,3	36,3		
		310	101,2	88,9	84,6	77,6	62,6		
		350		101,2	101,2	94,2	80,2		
		370				101,2	83,5		
		390					97,8		
		430					101,2		
25	158,09	250	97,9	78,1	72,6	64,7	45,3		
		280	126,5	94,6	89,4	81,2	61,8		
		370	158,1	144,0	127,9	119,7	111,2		
		410		158,1	150,0	141,8	123,2		
		430			158,1	150,0	144,2		
		450				158,1	155,2		
		500					158,1		
32	158,09	250	97,9	78,1	72,6	64,7	45,3		
		280	126,5	94,6	89,4	81,2	61,8		
		370	158,1	144,0	127,9	119,7	111,2		
		410		158,1	150,0	141,8	123,2		
		430			158,1	150,0	144,2		
		450				158,1	155,2		
		500					158,1		

**b) Fire situation “parallel”**

Max. bond stress,  $\tau_c$ , depending on actual clear concrete cover for classifying the fire resistance.

It must be verified that the actual force in the bar during a fire,  $F_{s,T}$ , can be taken up by the bar connection of the selected length,  $l_{inst}$ . Note: Cold design for ULS is mandatory.

$$F_{s,T} \leq (l_{inst} - c_f) \cdot \phi \cdot \pi \cdot \tau_c \quad \text{where: } (l_{inst} - c_f) \geq l_s;$$

$l_s$  = lap length

$\phi$  = nominal diameter of bar

$l_{inst} - c_f$  = selected overlap joint length; this must be at least  $l_s$ ,

but may not be assumed to be more than  $80 \phi$

$\tau_c$  = bond stress when exposed to fire

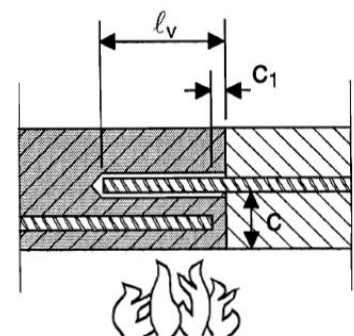

**Critical temperature-dependent bond stress,  $\tau_c$ , concerning “overlap joint” for Hilti HIT-HY 100 injection adhesive in relation to fire resistance class and required minimum concrete coverage c.**

Clear concrete cover c [mm]	Max. bond stress, $\tau_c$ [N/mm <sup>2</sup> ]					
	R30	R60	R90	R120	R180	
30	0,6	0,3	0	0	0	
35	0,7	0,3				
40	0,9	0,4	0,2			
45	1,0	0,4	0,2			
50	1,2	0,5	0,3			
55	1,5	0,6	0,3	0,2		
60	1,8	0,8	0,4	0,3		
65	2,2	0,9	0,5	0,3		
70		1,0	0,5	0,3		
75		1,2	0,6	0,4		0,2
80		1,5	0,7	0,5	0,3	
85		1,7	0,8	0,5	0,3	
90		2,0	1,0	0,6	0,3	
95		2,2	2,2	1,1	0,7	0,4
100				1,3	0,8	0,4
105				1,5	0,9	0,5
110				1,7	1,1	0,5
115	2,0			1,2	0,6	
120	2,2			2,2	1,4	0,6
125					1,6	0,7
130					1,9	0,8
135					2,1	0,9
200						2,3

**Materials**

**Material quality**

Part	Material
Rebar EN 1992-1-1	Bars and de-coiled rods class B or C with $f_{yk}$ and $k$ according to NDP or NCL of EN 1992-1-1 $f_{uk} = f_{tk} = k \cdot f_{yk}$

**Fitness for use**

Some creep tests have been conducted in accordance with ETAG guideline 001 part 5 and TR 023 in the following conditions : in dry environment at 50 °C during 90 days.  
These tests show an excellent behaviour of the post-installed connection made with HIT-HY 100: low displacements with long term stability, failure load after exposure above reference load.

**Resistance to chemical substances**

Chemical substance	Comment	Resistance
Sulphuric acid	23°C	+
Under sea water	23°C	+
Under water	23°C	+
Alkaline medium	pH = 13,2, 23°C	+

- + resistant
- o resistant in short term (max. 48h) contact
- not resistant

### Curing and working time

Temperature of the base material $T_{BM}$	Working time $t_{work}^{a)}$	Curing time $t_{cure}$
$-10\text{ °C} < T_{BM} < -6\text{ °C}$	180 min	12 h
$-5\text{ °C} < T_{BM} < -1\text{ °C}$	40 min	4 h
$0\text{ °C} < T_{BM} < +4\text{ °C}$	20 min	2 h
$+5\text{ °C} < T_{BM} < +9\text{ °C}$	8 min	1 h
$+10\text{ °C} < T_{BM} < +14\text{ °C}$	7 min	50 min
$+15\text{ °C} < T_{BM} < +19\text{ °C}$	6 min	40 min
$+20\text{ °C} < T_{BM} < +24\text{ °C}$	5 min	30 min
$+25\text{ °C} < T_{BM} < +29\text{ °C}$	3 min	30 min
$+30\text{ °C} < T_{BM} \leq +40\text{ °C}$	2 min	30 min

### Setting information

#### Installation equipment

Rebar [mm]	$\phi 8$	$\phi 10$	$\phi 12$	$\phi 14$	$\phi 16$	$\phi 18$	$\phi 20$	$\phi 22$	$\phi 24$	$\phi 25$
Rotary hammer	TE 2 – TE 40					TE 40 – TE 70				
Other tools	compressed air gun or blow out pump, set of cleaning brushes									

#### Drilling and cleaning diameters

Rebar [mm]	Hammer drill (HD)	Compressed air drill (CA)	Brush HIT-RB	Air nozzle HIT-RB
	$d_0$ [mm]		size [mm]	
$\phi 8$	12 / 10 <sup>a)</sup>	-	12 / 10 <sup>a)</sup>	12 / 10 <sup>a)</sup>
$\phi 10$	14 / 12 <sup>a)</sup>	-	14 / 12 <sup>a)</sup>	14 / 12 <sup>a)</sup>
$\phi 12$	16 / 14 <sup>a)</sup>	-	16 / 14 <sup>a)</sup>	16 / 14 <sup>a)</sup>
	-	17	18	16
$\phi 14$	18	17	18	18
	20	-	20	20
$\phi 16$	-	20	22	20
	22	22	22	22
$\phi 20$	25	-	25	25
	-	26	28	25
$\phi 22$	28	28	28	28
$\phi 24$	32	32	32	32
$\phi 25$	32	32	32	

a) Maximum installation length  $l=250$  mm.

#### Dispensers and corresponding maximum embedment depth $l_{v,max}$

Rebar	Dispenser
	HDM 330, HDM 500, HDE 500, HIT-MD 2000, HIT-MD 2500 HIT-ED 3500, HIT-P300F, HIT-P3500F
	$l_{v,max}$ [mm]
$\phi 8 - \phi 16$	700
$\phi 18 - \phi 25$	500

## Setting instructions

\*For detailed information on installation see instruction for use given with the package of the product.



### Safety regulations.

Review the Material Safety Data Sheet (MSDS) before use for proper and safe handling! Wear well-fitting protective goggles and protective gloves when working with Hilti HIT-HY 100.

### Drilling

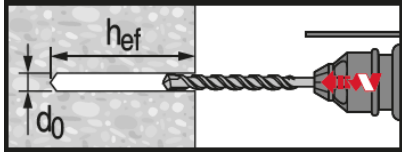

Hammer drilled hole (HD)

### Cleaning

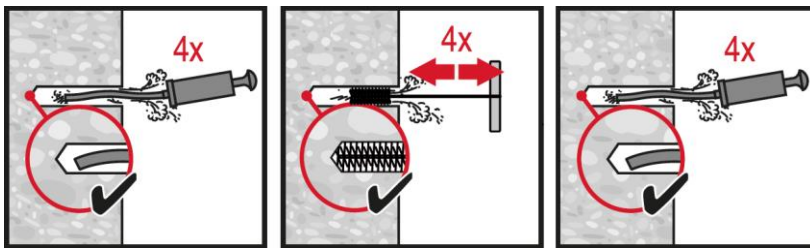

#### Manual cleaning (MC)

for drill diameters  $d_0 \leq 18$  mm and drill hole depth  $h_0 \leq 10 \cdot d_0$ .

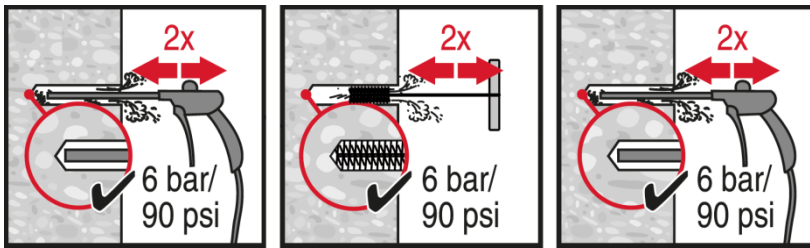

#### Compressed air cleaning (CAC)

for all drill hole diameters  $d_0$  and drill hole depths  $h_0$ .

### Injection system

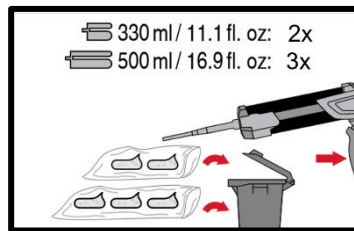
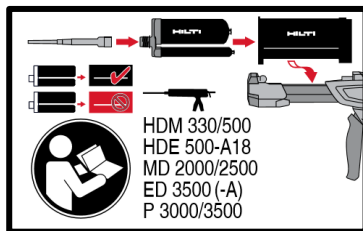

#### Injection system preparation.

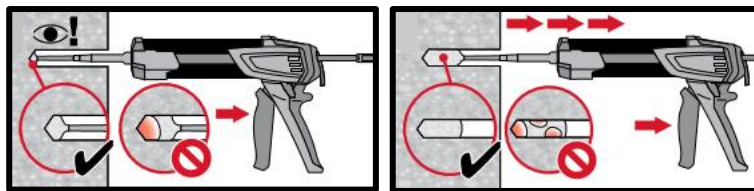

Injection method for drill hole depth  $h_{ef} \leq 250$  mm.

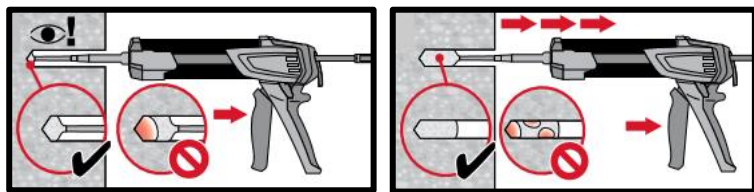

Injection method for application with embedment depth  $h_{ef} > 250$  mm.



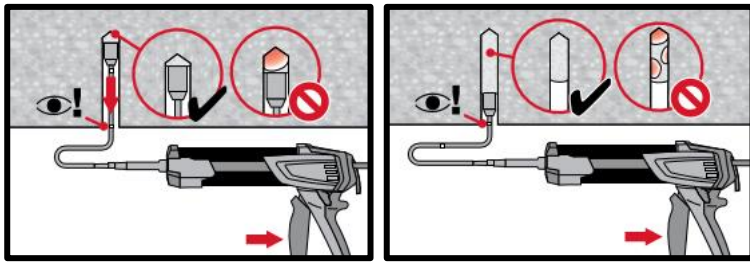

**Injection** method for overhead application and/or installation with embedment depth  $h_{ef} > 250$  mm.

**Setting the element**

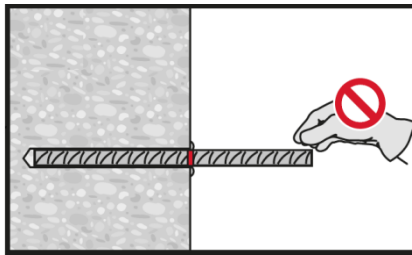
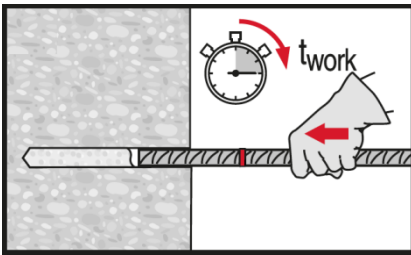

**Setting element**, observe working time "t<sub>work</sub>".

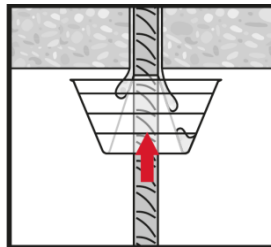
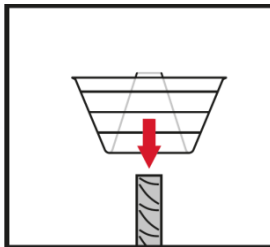
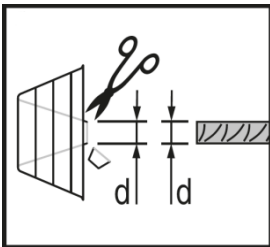

**Setting element** for overhead applications, observe working time "t<sub>work</sub>".

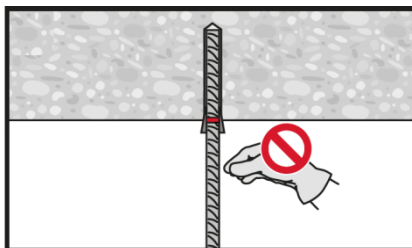
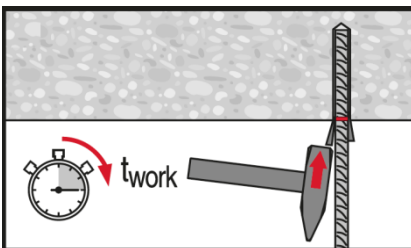

**Loading the anchor:** After required curing time  $t_{cure}$  the anchor can be loaded.

# HIT-CT 1 injection mortar

Anchor design (EN 1992-4) / Rods&Sleeves / Concrete

## Injection mortar system



Hilti HIT- CT 1

330 ml foil pack  
(also available as  
500 ml foil pack)



Anchor rods:  
HAS-U  
HAS-U HDG  
HAS-U A4  
HAS-U HCR  
(M8 - M24)

## Benefits

- **Clean-Tec** technology: HIT-CT 1 mortar contains no hazardous labels and protects users and the environment in the event of contact with the mortar.
- **SafeSet** technology: Hilti hollow drill bit for hammer drilling
- Suitable for non-cracked concrete C20/25 to C50/60
- Suitable for dry and water saturated concrete
- High loading capacity and fast curing
- Hybrid chemistry
- Good load capacity at elevated temperatures, and suitable for applications down to -5°C

## Base material



Concrete  
(non-cracked)



Dry concrete



Wet concrete

## Load condition

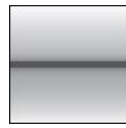

Static/  
quasi-static

## Installation conditions



Hammer  
drilling

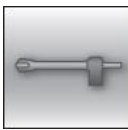

Hollow drill-  
bit drilling

**SAFESET**

Hilti **SafeSet**  
technology

## Other information



European  
Technical  
Assessment



Hilti Clean  
technology



CE  
conformity



PROFIS  
Rebar design  
Software

## Approvals / certificates

Description	Authority / Laboratory	No. / date of issue
European technical assessment <sup>a)</sup>	CSTB, Marne la Vallée	ETA-11/0354 / 2019-09-06

a) All data given in this section according to ETA-11/0354 issue 2019-09-06.

## Static and quasi-static loading (for a single anchor)

### All data in this section applies to

- Correct setting
- No edge distance and spacing influence
- Steel failure
- Base material thickness, as specified in the table
- One typical embedment depth, as specified in the table
- One anchor material, as specified in the tables
- Concrete C 20/25,  $f_{ck,cube} = 25 \text{ N/mm}^2$
- Temperate range I  
(min. base material temperature  $-40^\circ\text{C}$ , max. long term/short term base material temperature:  $+24^\circ\text{C}/40^\circ\text{C}$ )

### Embedment depth and base material thickness

Anchor- size		M8	M10	M12	M16	M20	M24
Typical embedment depth	$h_{ef}$ [mm]	80	90	110	125	170	210
Base material thickness	$h_{min}$ [mm]	110	120	140	160	220	270

For hammer drilled holes and Hilti hollow drill bit <sup>a)</sup>:

### Characteristic resistance

Anchor size		M8	M10	M12	M16	M20	M24
<b>Non-cracked concrete</b>							
Tension $N_{Rk}$	HAS-U 5.8	18,0	29,0	42,0	62,8	102	143
	HAS-U 8.8	24,1	31,1	45,6	62,8	102	143
	HAS-U A4	24,1	31,1	45,6	62,8	102	143
	HAS-U HCR	24,1	31,1	45,6	62,8	102	143
Shear $V_{Rk}$	HAS-U 5.8	9,0	15,0	21,0	39,0	61,0	88,0
	HAS-U 8.8	15,0	23,0	34,0	63,0	98,0	141
	HAS-U A4	13,0	20,0	30,0	55,0	86,0	124
	HAS-U HCR	15,0	23,0	34,0	63,0	98,0	124

a) Hilti hollow drill bit available for element size M12-M24.

### Design resistance

Anchor size		M8	M10	M12	M16	M20	M24
<b>Non-cracked concrete</b>							
Tension $N_{Rd}$	HAS-U 5.8	12,0	17,3	25,3	34,9	56,4	79,2
	HAS-U 8.8	13,4	17,3	25,3	34,9	56,4	79,2
	HAS-U A4	13,4	17,3	25,3	34,9	56,4	79,2
	HAS-U HCR	13,4	17,3	25,3	34,9	56,4	79,2
Shear $V_{Rd}$	HAS-U 5.8	7,2	12,0	16,8	31,2	48,8	70,4
	HAS-U 8.8	12,0	18,4	27,2	50,4	78,4	113
	HAS-U A4	8,3	12,8	19,2	35,3	55,1	79,5
	HAS-U HCR	12,0	18,4	27,2	50,4	78,4	70,9

a) Hilti hollow drill bit available for element size M12-M24.

**Recommended loads <sup>b)</sup>**

Anchor size		M8	M10	M12	M16	M20	M24
<b>Non-cracked concrete</b>							
Tension $N_{Rec}$	HAS-U 5.8	8,6	12,3	18,1	24,9	40,3	56,5
	HAS-U 8.8	9,6	12,3	18,1	24,9	40,3	56,5
	HAS-U A4	9,6	12,3	18,1	24,9	40,3	56,5
	HAS-U HCR	9,6	12,3	18,1	24,9	40,3	56,5
Shear $V_{Rec}$	HAS-U 5.8	5,1	8,6	12,0	22,3	34,9	50,3
	HAS-U 8.8	8,6	13,1	19,4	36,0	56,0	80,6
	HAS-U A4	6,0	9,2	13,7	25,2	39,4	56,8
	HAS-U HCR	8,6	13,1	19,4	36,0	56,0	50,6

a) Hilti hollow drill bit available for element size M12-M24.

b) With overall partial safety factor for action  $\gamma=1,4$ . The partial safety factors for action depend on the type of loading and shall be taken from national regulations.

**Materials**
**Mechanical properties**

Anchor size		M8	M10	M12	M16	M20	M24	
Nominal tensile strength $f_{uk}$	HAS-U 5.8	500	500	500	500	500	500	
	HAS-U 8.8	800	800	800	800	800	800	
	HAS-U A4	700	700	700	700	700	700	
	HAS-U HCR	800	800	800	800	800	700	
Yield strength $f_{yk}$	HAS-U 5.8	400	400	400	400	400	400	
	HAS-U 8.8	640	640	640	640	640	640	
	HAS-U A4	450	450	450	450	450	450	
	HAS-U HCR	600	600	600	600	600	400	
Stressed cross-section $A_s$	HAS-U	[mm <sup>2</sup> ]	36,6	58,0	84,3	157	245	353
Moment of resistance $W$	HAS-U	[mm <sup>3</sup> ]	31,2	62,3	109	277	541	935

**Material quality for HAS-U**

Part	Material
<b>Zinc coated steel</b>	
Threaded rod, HAS-U 5.8 (HDG)	Strength class 5.8; Elongation at fracture A5 > 8% ductile Electroplated zinc coated $\geq 5\mu\text{m}$ ; (F) hot dip galvanized $\geq 45\mu\text{m}$
Threaded rod, HAS-U 8.8 (HDG)	Strength class 8.8; Elongation at fracture A5 > 12% ductile Electroplated zinc coated $\geq 5\mu\text{m}$ ; (F) hot dip galvanized $\geq 45\mu\text{m}$
Hilti Meter rod, AM 8.8 (HDG)	Strength class 8.8; Elongation at fracture A5 > 12% ductile Electroplated zinc coated $\geq 5\mu\text{m}$ (HDG) hot dip galvanized $\geq 45\mu\text{m}$
Washer	Electroplated zinc coated $\geq 5\mu\text{m}$ , hot dip galvanized $\geq 45\mu\text{m}$
Nut	Strength class of nut adapted to strength class of threaded rod. Electroplated zinc coated $\geq 5\mu\text{m}$ , hot dip galvanized $\geq 45\mu\text{m}$
<b>Stainless Steel</b>	
Threaded rod, HAS-U A4	Strength class 70 for $\leq M24$ and strength class 50 for $> M24$ ; Elongation at fracture A5 > 8% ductile Stainless steel 1.4401; 1.4404; 1.4578; 1.4571; 1.4439; 1.4362
Washer	Stainless steel 1.4401, 1.4404, 1.4578, 1.4571, 1.4439, 1.4362 EN 10088-1:2014
Nut	Stainless steel 1.4401, 1.4404, 1.4578, 1.4571, 1.4439, 1.4362 EN 10088-1:2014
<b>High corrosion resistant steel</b>	
Threaded rod, HAS-U HCR	Strength class 80 for $\leq M20$ and class 70 for $> M20$ , Elongation at fracture A5 > 8% ductile High corrosion resistance steel 1.4529; 1.4565;
Washer	High corrosion resistant steel 1.4529, 1.4565 EN 10088-1:2014
Nut	High corrosion resistant steel 1.4529, 1.4565 EN 10088-1:2014

## Setting information

### Installation temperature:

-5°C to +40°C

### Service temperature range:

Hilti HIT-CT 1 injection mortar may be applied in the temperature ranges given below. An elevated base material temperature may lead to a reduction of the design bond resistance.

Temperature range	Base material temperature	Max, long term base material temperature	Max, short term base material temperature
Temperature range I	-40 °C to + 40 °C	+ 24 °C	+ 40 °C
Temperature range II	-40 °C to + 80 °C	+ 50 °C	+ 80 °C

### Max, short term base material temperature

Short term elevated base material temperatures are those that occur over brief intervals, e.g. as a result of diurnal cycling.

### Max, long term base material temperature

Long term elevated base material temperatures are roughly constant over significant periods of time.

### Working time and curing time

Temperature of the base material	Max, working time in which anchor can be inserted and adjusted $t_{work}$	Min, curing time before anchor can be fully loaded $t_{cure}^{1)}$
$-5\text{ °C} < t_{BM} < 0\text{ °C}$	1 hour	6 hours
$0\text{ °C} \leq t_{BM} < 5\text{ °C}$	40 min	3 hours
$5\text{ °C} \leq t_{BM} < 10\text{ °C}$	25 min	2 hours
$10\text{ °C} \leq t_{BM} < 20\text{ °C}$	10 min	90 min
$20\text{ °C} \leq t_{BM} < 30\text{ °C}$	4 min	75 min
$30\text{ °C} \leq t_{BM} < 40\text{ °C}$	2 min	60 min

1) The curing time data are valid for dry base material only. In wet material the curing times must be doubled.

### Setting details HAS-U

Anchor size		M8	M10	M12	M16	M20	M24	
Nominal diameter of drill bit $d_0$	[mm]	10	12	14	18	22	28	
Effective anchorage and drill hole depth range <sup>a)</sup>	$h_{ef,min}$	64	80	96	128	160	192	
	$h_{ef,max}$	96	120	144	192	240	288	
Min. base material thickness	$h_{min}$	$h_{ef} + 30 \text{ mm} \geq 100 \text{ mm}$			$h_{ef} + 2 d_0$			
Min. spacing	$s_{min}$	40	50	60	80	100	120	
Min. edge distance	$c_{min}$	40	45	45	50	55	60	
Max. diameter of clearance hole in the fixture	$d_f$	9	12	14	18	22	26	
Max. torque moment <sup>b)</sup>	$T_{max}$	10	20	40	80	150	200	
Critical spacing for splitting failure	$s_{cr,sp}$	$2 c_{cr,sp}$						
Critical edge distance for splitting failure <sup>b)</sup>	$c_{cr,sp}$	[mm]	$1,0 \cdot h_{ef}$ for $h / h_{ef} \geq 2,0$					
			$4,6 h_{ef} - 1,8 h$ for $2,0 > h / h_{ef} > 1,3$					
			$2,26 h_{ef}$ for $h / h_{ef} \leq 1,3$					
Critical spacing for concrete cone failure	$s_{cr,N}$	$2 c_{cr,N}$						
Critical edge distance for concrete cone failure <sup>c)</sup>	$c_{cr,N}$	$1,5 h_{ef}$						

For spacing (edge distance) smaller than critical spacing (critical edge distance) the design loads have to be reduced.

- a)  $h_{ef,min} \leq h_{ef} \leq h_{ef,max}$  ( $h_{ef}$ : embedment depth)
- b) Max. recommended torque moment to avoid splitting failure during installation with min. spacing and/or edge distance
- c)  $h$ : base material thickness ( $h \geq h_{min}$ )
- d) The critical edge distance for concrete cone failure depends on the embedment depth  $h_{ef}$  and the design bond resistance. The simplified formula given in this table is on the save side.

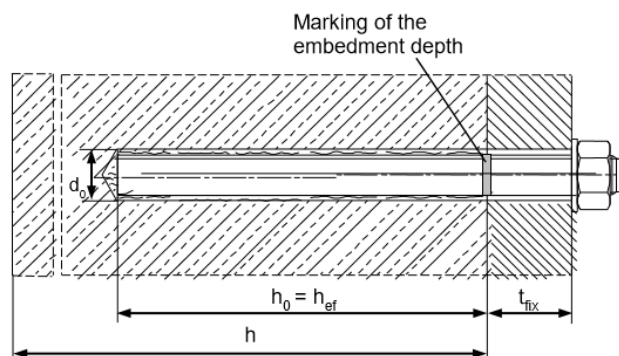
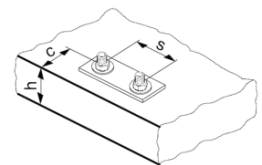

### Installation equipment

Anchor size	M8	M10	M12	M16	M20	M24
Rotary hammer	TE 2 (-A) – TE 16 (-A)				TE 40 – TE 80	
Other tools	Compressed air gun, blow out pump Set of cleaning brushes, dispenser					

Concrete  
Chemical anchors  
Mechanical anchors  
Plastic/Light duty metal anchors  
Insulation anchors

### Drilling and cleaning parameters

HAS-U	Hammer drill (HD)	Hollow Drill Bit (HDB)	Brush HIT-RB	Air nozzle HIT-RB
	d <sub>0</sub> [mm]		size [mm]	
M8	10	-	10	-
M10	12	-	12	12
M12	14	14	14	14
M16	18	18	18	18
M20	22	22	22	22
M24	28	28	28	28

### Setting instructions

\*For detailed information on installation see instruction for use given with the package of the product.



#### Safety regulations,

Review the Material Safety Data Sheet (MSDS) before use for proper and safe handling! Wear well-fitting protective goggles and protective gloves when working with Hilti HIT-CT 1.

### Drilling

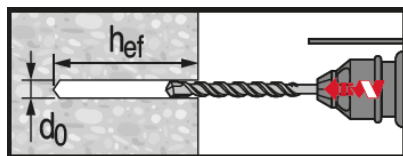

Hammer drilled hole (HD)

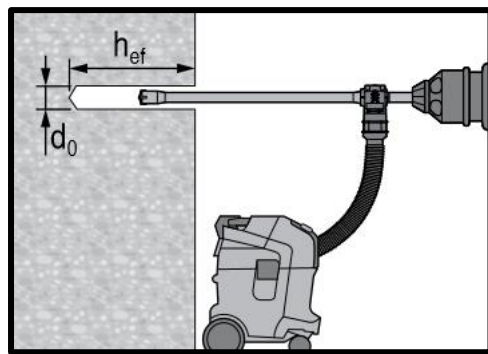

Hammer drilled hole with Hollow drill bit (HDB)  
No cleaning required

### Cleaning

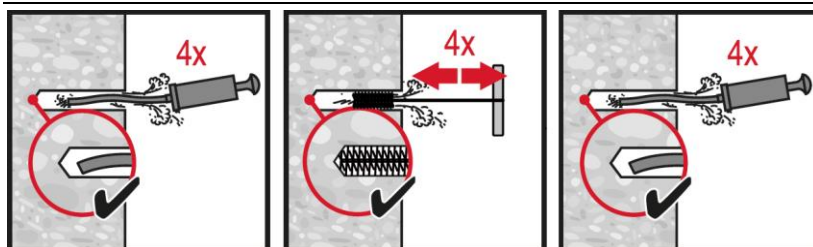

#### Manual cleaning (MC)

for drill diameters  $d_0 \leq 20$  mm and drill hole depth  $h_0 \leq 10 \cdot d$ .

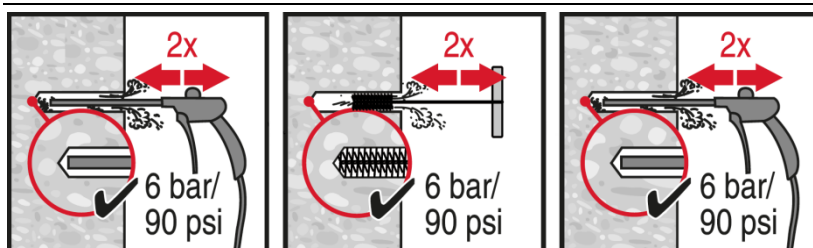

#### Compressed air cleaning (CAC)

for all drill hole diameters  $d_0$  and drill hole depths  $h_0 \leq 20 \cdot d$ .



## Injection

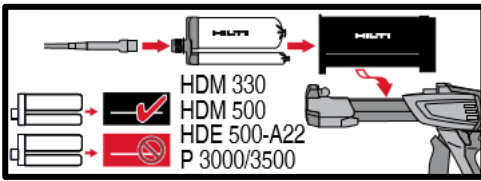

Injection system preparation

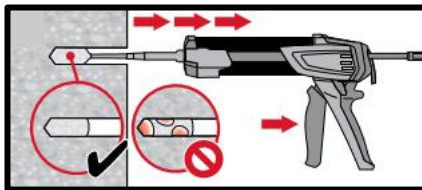
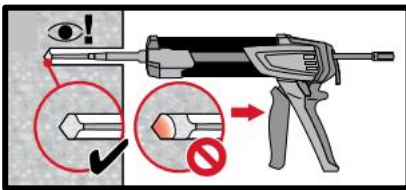
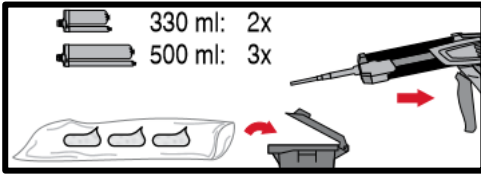

Injection method for drill hole depth  $h_{ef} \leq 250$  mm.

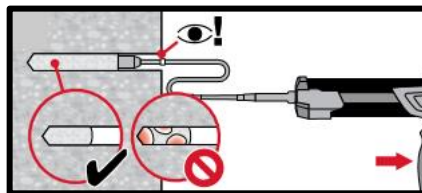
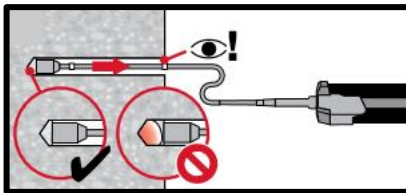

Injection method for drill hole depth  $h_{ef} > 250$  mm.

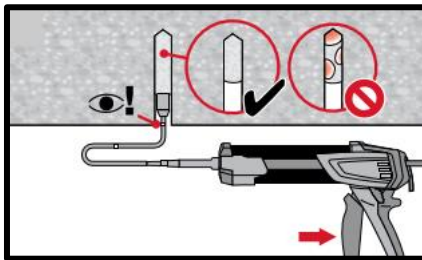
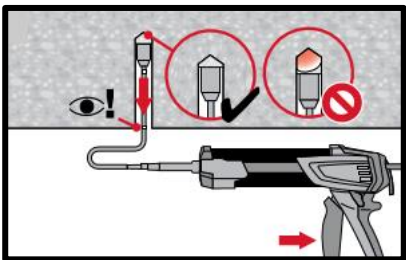

Injection method for overhead application

## Setting the element

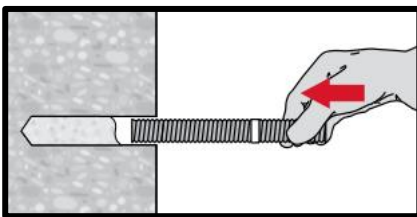

Setting element, observe working time  $t_{work}$ .

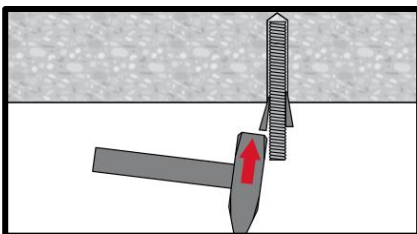

Setting element for overhead applications, observe working time  $t_{work}$ .

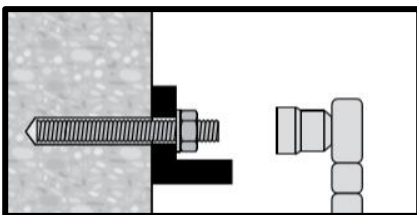

Loading the anchor: After required curing time  $t_{cure}$  the anchor can be loaded.



Concrete

Chemical anchors

Mechanical anchors

Plastic/Light duty metal anchors

Insulation anchors

# HIT-CT 1 injection mortar

Anchor design (EN 1992-4) / Rebar elements / Concrete











Concrete  
Chemical anchors

Mechanical anchors

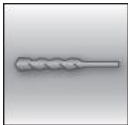
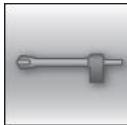
Plastic/Light duty metal anchors

Insulation anchors

Injection mortar system	Benefits
 <p>Hilti HIT- CT 1 330 ml foil pack (also available as 500 ml foil pack)</p>	<ul style="list-style-type: none"> <li>- <b>Clean-Tec</b> technology: HIT-CT 1 mortar contains no hazardous labels and protects users and the environment in the event of contact with the mortar.</li> <li>- <b>SafeSet</b> technology: Hilti hollow drill bit for hammer drilling</li> <li>- Suitable for non-cracked concrete C20/25 to C50/60</li> <li>- Suitable for dry and water saturated concrete</li> <li>- High loading capacity and fast curing</li> <li>- Hybrid chemistry</li> <li>- Good load capacity at elevated temperatures, and suitable for applications down to -5°C</li> </ul>
 <p>Rebar B500 B (<math>\phi 8</math>-<math>\phi 25</math>)</p>	

Base material	Load condition
 <p>Concrete (non-cracked)</p>  <p>Dry concrete</p>  <p>Wet concrete</p>	 <p>Static/ quasi-static</p>
Installation conditions	Other information
 <p>Hammer drilling</p>  <p>Hollow drill-bit drilling</p>  <p>Hilti <b>SafeSet</b> technology</p>	 <p>European Technical Assessment</p>  <p>Hilti Clean technology</p>  <p>CE conformity</p>  <p>PROFIS Rebar design Software</p>

**Approvals / certificates**

Description	Authority / Laboratory	No. / date of issue
European technical assessment <sup>a)</sup>	CSTB, Marne la Vallée	ETA-11/0354 / 2019-09-06

b) All data given in this section according to ETA-11/0354 issue 2019-09-06.

## Static and quasi-static loading (for a single anchor)

### All data in this section applies to

- Correct setting
- No edge distance and spacing influence
- Steel failure
- Base material thickness, as specified in the table
- One typical embedment depth, as specified in the table
- Anchor material: rebar B500 B
- Concrete C 20/25,  $f_{ck,cube} = 25 \text{ N/mm}^2$
- Temperature range I  
(min. base material temperature  $-40^\circ\text{C}$ , max. long term/short term base material temperature:  $+24^\circ\text{C}/40^\circ\text{C}$ )

### Embedment depth and base material thickness for static and quasi-static loading data

Anchor- size	$\phi 8$	$\phi 10$	$\phi 12$	$\phi 14$	$\phi 16$	$\phi 20$	$\phi 25$
Typical embedment depth [mm]	80	90	110	125	125	170	210
Base material thickness [mm]	110	120	145	160	165	220	274

### For hammer drilled holes and Hilti hollow drill bit<sup>a)</sup>:

#### Characteristic resistance

Anchor- size	$\phi 8$	$\phi 10$	$\phi 12$	$\phi 14$	$\phi 16$	$\phi 20$	$\phi 25$
Tensile $N_{Rk}$	14,1	21,2	31,1	41,2	47,1	85,5	132
Shear $V_{Rk}$ [kN]	14,0	22,0	31,0	42,0	55,0	86,0	135

a) Hilti hollow drill bit available for element size M12-M25.

#### Design resistance

Anchor- size	$\phi 8$	$\phi 10$	$\phi 12$	$\phi 14$	$\phi 16$	$\phi 20$	$\phi 25$
Tensile $N_{Rd}$	7,8	11,8	17,3	22,9	26,2	47,5	73,3
Shear $V_{Rd}$ [kN]	9,3	14,7	20,7	28,0	36,7	57,3	90,0

1) Hilti hollow drill bit available for element size M12-M25.

#### Recommended loads<sup>b)</sup>

Anchor- size	$\phi 8$	$\phi 10$	$\phi 12$	$\phi 14$	$\phi 16$	$\phi 20$	$\phi 25$
Tensile $N_{Rec}$	5,6	8,4	12,3	16,4	18,7	33,9	52,4
Shear $V_{Rec}$ [kN]	6,7	10,5	14,8	20,0	26,2	41,0	64,3

a) Hilti hollow drill bit available for element size M12-M25.

b) With overall partial safety factor for action  $\gamma = 1,4$ . The partial safety factors for action depend on the type of loading and shall be taken from national regulations.

## Materials

### Mechanical properties

Anchor size		φ8	φ10	φ12	φ14	φ16	φ20	φ25
Nominal tensile strength $f_{uk}$ [N/mm <sup>2</sup> ]		550	550	550	550	550	550	550
Yield strength $f_{yk}$ [N/mm <sup>2</sup> ]		500	500	500	500	500	500	500
Stressed cross-section $A_s$ [mm <sup>2</sup> ]		50,3	78,5	113	1534	201	314	491
Moment of resistance $W$ [mm <sup>3</sup> ]		50,3	98,2	170	269	402	785	1534

### Material quality

Part	Material
Rebar B500 B	EN 1992-1-1:2004 and AC:2010, Annex C Bars and de-coiled rods Class B or C with $f_{yk}$ and $k$ according to NDP or NCL of EN 1992-1-1/NA:2013

### Setting information

#### Installation temperature:

-5°C to +40°C

#### Service temperature range:

Hilti HIT-CT 1 injection mortar may be applied in the temperature ranges given below. An elevated base material temperature may lead to a reduction of the design bond resistance.

Temperature range	Base material temperature	Max, long term base material temperature	Max, short term base material temperature
Temperature range I	-40 °C to + 40 °C	+ 24 °C	+ 40 °C
Temperature range II	-40 °C to + 80 °C	+ 50 °C	+ 80 °C

#### Max, short term base material temperature

Short term elevated base material temperatures are those that occur over brief intervals, e.g. as a result of diurnal cycling.

#### Max, long term base material temperature

Long term elevated base material temperatures are roughly constant over significant periods of time.

### Working time and curing time

Temperature of the base material	Max, working time in which anchor can be inserted and adjusted $t_{work}$	Min, curing time before anchor can be fully loaded $t_{cure}^{1)}$
-5 °C < $t_{BM}$ < 0 °C	1 hour	6 hours
0 °C ≤ $t_{BM}$ < 5 °C	40 min	3 hours
5 °C ≤ $t_{BM}$ < 10 °C	25 min	2 hours
10 °C ≤ $t_{BM}$ < 20 °C	10 min	90 min
20 °C ≤ $t_{BM}$ < 30 °C	4 min	75 min
30 °C ≤ $t_{BM}$ < 40 °C	2 min	60 min

1) The curing time data are valid for dry base material only. In wet material the curing times must be doubled.

### Setting details

Anchor size		φ8	φ10	φ12	φ14	φ16	φ20	φ25
Nominal diameter of drill bit	$d_0$ [mm]	10 / 12 <sup>a)</sup>	12 / 14 <sup>a)</sup>	14 <sup>a)</sup> / 16 <sup>a)</sup>	18	20	25	30 / 32 <sup>a)</sup>
Effective anchorage and drill hole depth range	$h_{ef,min}$ [mm]	64	80	96	112	128	160	200
	$h_{ef,max}$ [mm]	96	120	144	168	192	240	300
Minimum base material thickness	$h_{min}$ [mm]	$h_{ef} + 30 \text{ mm}$ $\geq 100 \text{ mm}$			$h_{ef} + 2 d_0$			
Min. spacing	$s_{min}$ [mm]	40	50	60	70	80	100	125
Min. edge distance	$c_{min}$ [mm]	40	45	45	50	50	65	70
Critical spacing for splitting failure	$s_{cr,sp}$ [mm]	$2 c_{cr,sp}$						
Critical edge distance for splitting failure <sup>b)</sup>	$c_{cr,sp}$ [mm]	$1,0 \cdot h_{ef}$		for $h / h_{ef} \geq 2,0$				
		$4,6 h_{ef} - 1,8 h$		for $2,0 > h / h_{ef} > 1,3$				
		$2,26 h_{ef}$		for $h / h_{ef} \leq 1,3$				
Critical spacing for concrete cone failure	$s_{cr,N}$ [mm]	$3,0 h_{ef}$						
Critical edge distance for concrete cone failure <sup>c)</sup>	$c_{cr,N}$ [mm]	$1,5 h_{ef}$						

For spacing (edge distance) smaller than critical spacing (critical edge distance) the design loads have to be reduced.

- a) Both given values for drill bit diameter can be used
- b)  $h$ : base material thickness ( $h \geq h_{min}$ ),  $h_{ef}$ : embedment depth
- c) The critical edge distance for concrete cone failure depends on the embedment depth  $h_{ef}$  and the design bond resistance. The simplified formula given in this table is on the safe side.

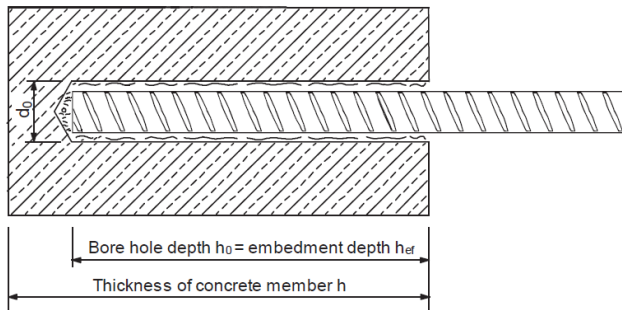
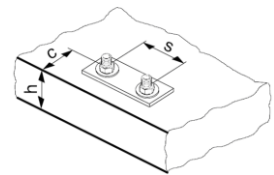

### Installation equipment

Anchor size	φ8	φ10	φ12	φ14	φ16	φ20	φ25
Rotary hammer	TE 2 – TE 30					TE 40 – TE 80	
Other tools	compressed air gun or blow out pump set of cleaning brushes, dispenser						

## Drilling and cleaning parameters

Rebar	Hammer drilling (HD)	Hollow Drill Bit (HDB)	Brush HIT-RB	Piston plug HIT-SZ
	$d_0$ [mm]		size [mm]	
$\phi 8$	10 / 12 <sup>a)</sup>	-	10 / 12 <sup>a)</sup>	- / 12
$\phi 10$	12 / 14 <sup>a)</sup>	14	12 / 14 <sup>a)</sup>	12 / 14 <sup>a)</sup>
$\phi 12$	14 / 16 <sup>a)</sup>	16 (14 <sup>a)</sup> )	14 / 16 <sup>a)</sup>	14 / 16 <sup>a)</sup>
$\phi 14$	18	18	18	18
$\phi 16$	20	20	20	20
$\phi 20$	25	25	25	25
$\phi 25$	32	32	32	32

a) Each of the two given values can be used

## Setting instructions

\*For detailed information on installation see instruction for use given with the package of the product.



### Safety regulations,

Review the Material Safety Data Sheet (MSDS) before use for proper and safe handling! Wear well-fitting protective goggles and protective gloves when working with Hilti HIT-CT 1.

## Drilling

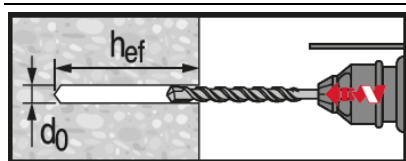

Hammer drilled hole (HD)

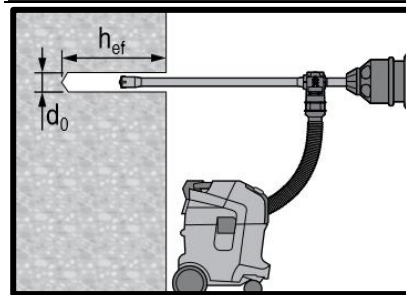

Hammer drilled hole with Hollow drill bit (HDB)

No cleaning required

## Cleaning

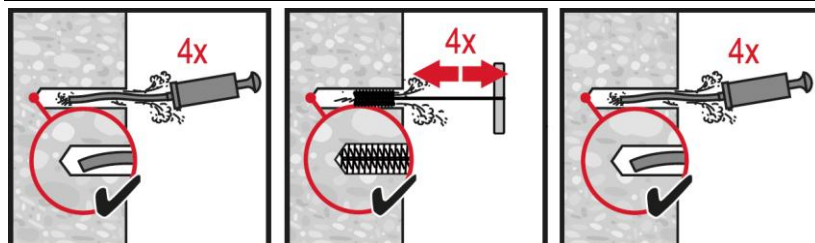

### Manual cleaning (MC)

for drill diameters  $d_0 \leq 20$  mm and drill hole depth  $h_0 \leq 10 \cdot d_0$ .

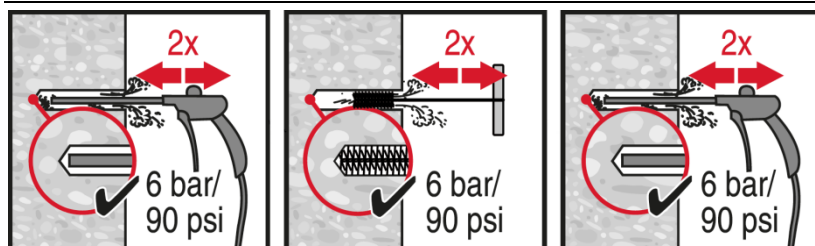

### Compressed air cleaning (CAC)

for all drill hole diameters  $d_0$  and drill hole depths  $h_0 \leq 20 \cdot d_0$ .



## Injection

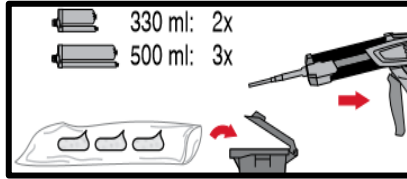
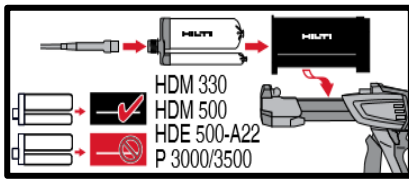

Injection system preparation

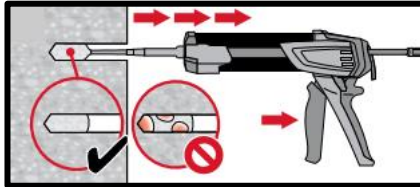
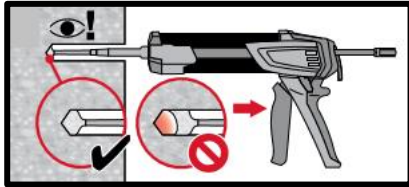

Injection method for drill hole depth  $h_{ef} \leq 250$  mm.

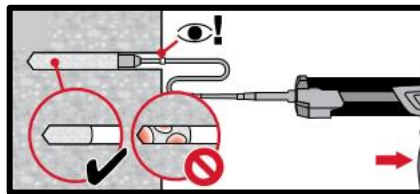
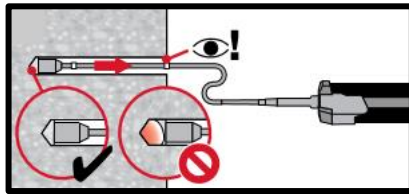

Injection method for drill hole depth  $h_{ef} > 250$  mm.

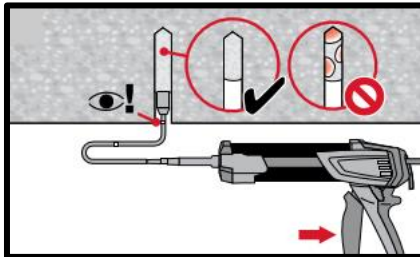
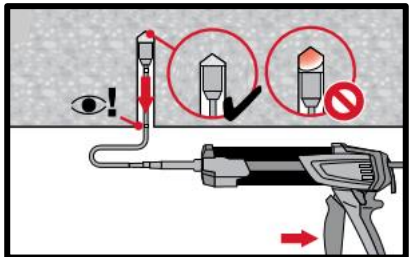

Injection method for overhead application

## Setting the element

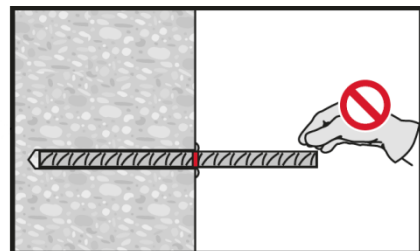
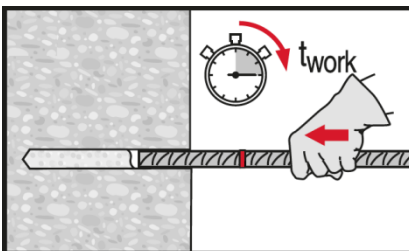

Setting element, observe working time " $t_{work}$ ".

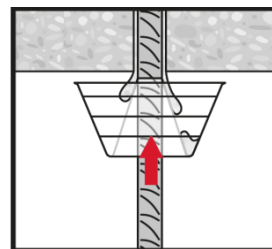
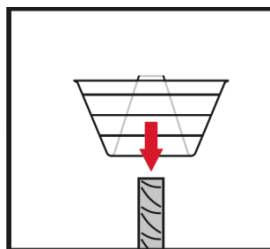
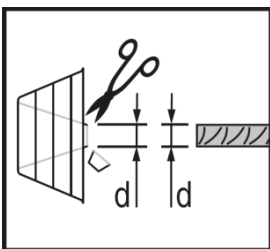

Setting element for overhead applications, observe working time " $t_{work}$ ".

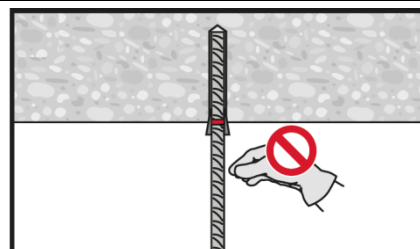
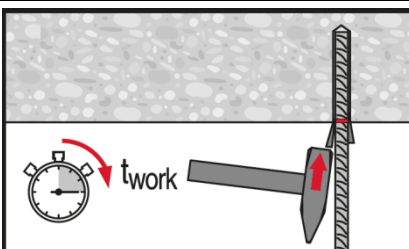

Loading the anchor: After required curing time  $t_{cure}$  the anchor can be loaded.

# HIT-CT 1 injection mortar

Rebar design (EOTA TR023) / Rebar elements / Concrete

## Injection mortar system



Hilti HIT- CT 1

330 ml foil pack  
(also available as  
500 ml foil pack)



Rebar B500 B  
( $\phi 8 - \phi 25$ )

## Benefits

- **Clean-Tec** technology: HIT-CT 1 mortar contains no hazardous labels and protects users and the environment in the event of contact with the mortar.
- **SafeSet** technology: Hilti hollow drill bit for hammer drilling
- Suitable for concrete C12/15 to C50/60
- Suitable for dry or wet concrete
- High loading capacity and fast curing
- Hybrid chemistry
- Suitable for dry and water saturated concrete
- For rebar diameters up to 25 mm
- Non-corrosive to rebar elements

## Base material



Concrete  
(non-cracked)



Dry concrete



Wet  
concrete



Static/  
quasi-static



Fire  
resistance

## Load conditions

## Installation conditions

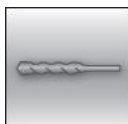

Hammer  
drilled holes

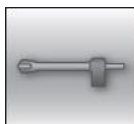

Hollow drill-  
bit drilling

**SAFESET**

Hilti **SafeSet**  
technology  
with hollow  
drill bit



European  
Technical  
Assessment



Hilti Clean  
technology



CE  
conformity



PROFIS  
Rebar design  
software

## Other information

## Approvals / certificates

Description	Authority / Laboratory	No. / date of issue
European Technical Assessment <sup>a)</sup>	CSTB, Marne la Vallée	ETA-11/0390 / 2016-11-01
Fire report	CSTB, Marne la Vallée	n° 26059386 / 2015-10-23

c) All data given in this section according to the approvals mentioned above ETA-11/0390 issue 2016-11-01

## Static and quasi-static loading

### Static EC2 design

#### Design bond strength in N/mm<sup>2</sup> accord. to ETA 11/0390 for good bond conditions

All allowed drilling methods									
Rebar - size	Concrete class								
	C12/15	C16/20	C20/25	C25/30	C30/37	C35/45	C40/50	C45/55	C50/60
φ8 - φ25	1,6	2,0	2,3	2,7	3,0	3,0	3,0	3,0	3,0

For poor bond conditions multiply the values by 0,7. Values valid for non-cracked and cracked concrete

### Minimum anchorage length and minimum lap length

The minimum anchorage length  $\ell_{b,min}$  and the minimum lap length  $\ell_{0,min}$  according to EN 1992-1-1 shall be multiplied by relevant **Amplification factor  $\alpha_{lb}$**  in the table below.

#### Amplification factor $\alpha_{lb}$ for the min. anchorage length and min. lap length according to EN 1992-1-1 for:

All allowed drilling methods									
Rebar - size	Concrete class								
	C12/15	C16/20	C20/25	C25/30	C30/37	C35/45	C40/50	C45/55	C50/60
φ8 - φ25	1,0			1,2	1,4				

#### Anchorage length for characteristic steel strength $f_{yk}=500$ N/mm<sup>2</sup> for good conditions

All allowed drilling methods								
Size	$f_{y,k}$ [N/mm <sup>2</sup> ]	$\ell_{b,min}^*$ [mm]			$\ell_{0,min}^*$ [mm]			$\ell_{max}$ [mm]
		C20/25	C25/30	C30/37- C50/60	C20/25	C25/30	C30/37- C50/60	
φ8	500	113	120	140	200	240	280	700
φ10	500	142	145	152	200	240	280	700
φ12	500	170	174	183	200	240	280	700
φ14	500	199	203	213	210	252	294	700
φ16	500	227	232	244	240	288	336	700
φ18	500	255	261	274	270	324	378	500
φ20	500	284	290	305	300	360	420	500
φ22	500	312	319	335	330	396	462	500
φ24	500	340	348	365	360	432	-	500
φ25	500	355	363	381	375	450	-	500

According to EN 1992-1-1  $\ell_{b,min}$  (8.6) are calculated for good bond conditions with maximum yield strength  $f_{yk}=1,15$  and  $\alpha_6 = 1,0$

Temperature reduction factor  $k_{fi}(\theta)$

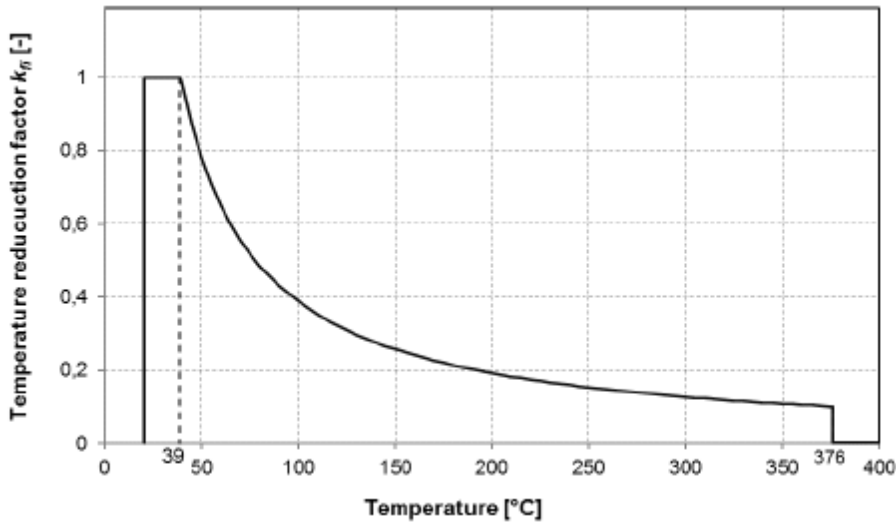

The analytic equation that describe the variation of  $k_{fi}(\theta)$  with temperature is given by the following function:

If  $39^\circ\text{C} \leq \theta \leq 376^\circ\text{C}$ :  $k_{fi}(\theta) = 41,001 \times \theta^{-1,012} \leq 1,0$   $\theta$  in  $^\circ\text{C}$   
 If  $\theta < 39^\circ\text{C}$ :  $k_{fi}(\theta) = 1.0$   
 If  $\theta > 376^\circ\text{C}$ :  $k_{fi}(\theta) = 0.0$

The design value of ultimate bond strength  $f_{bd,fi}$  under fire exposure is calculated according to following equation:

$$f_{bd,fi} = k_{fi}(\theta) \cdot f_{bd} \cdot \gamma_c / \gamma_{M,fi}$$

With:

- $k_{fi}(\theta)$  temperature reduction factor under fire exposure.
- $f_{bd}$  design values of the ultimate bond resistance according to amplification factor  $\alpha_{1b}$
- $\gamma_c = 1,5$  recommended safety factor according to EN 1992-1-1.
- $\gamma_{M,fi}$  safety factor according to EN 1992-1-2 under fire exposure.

a) Anchoring application

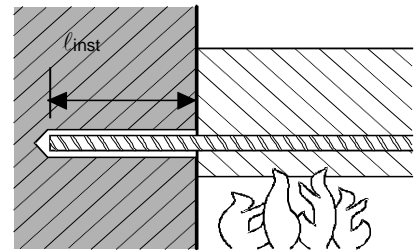

Anchoring application beam-wall connections with a concrete cover of 20 mm

Maximum force ( $F_{s,T,max}$ ) in rebar in conjunction with HIT-CT 1 as a function of embedment depth ( $l_{inst}$ ) for the fire resistance classes R30 to R240 according to EC2.

Rebar-size	$F_{s,T,max}$ [kN]	$l_{inst}$ [mm]	Fire resistance of bar [kN]					
			R30	R60	R90	R120	R180	R240
$\phi 8$	16,8	100	4,0	2,0	1,2	0,9	0,5	0,3
		140	7,4	4,7	3,0	2,3	1,5	1,1
		180	10,9	8,2	6,1	4,6	3,0	2,2
		220	14,4	11,7	9,5	7,9	5,3	3,9
		250	16,8	14,3	12,1	10,5	7,6	5,6
		280		16,8	14,7	13,1	10,2	7,9
		310	16,8	16,8	16,8	15,7	12,8	10,4
		330				16,8	14,5	12,2
		360	16,8	16,8	16,8	16,8	16,8	14,8
		390						16,8

Maximum force ( $F_{s,T,max}$ ) in rebar in conjunction with HIT-CT 1 as a function of embedment depth ( $\ell_{inst}$ ) for the fire resistance classes F30 to F240 according to EC2.

Rebar-size	$F_{s,T,max}$ [kN]	$\ell_{inst}$ [mm]	Fire resistance of bar [kN]							
			R30	R60	R90	R120	R180	R240		
$\phi 10$	26,2	110	6,0	3,1	2,0	1,5	0,9	0,6		
		150	10,4	7,0	4,6	3,5	2,2	1,6		
		190	14,7	11,3	8,7	6,7	4,3	3,2		
		230	19,0	15,7	13,0	10,9	7,5	5,6		
		300	26,2	26,2	23,3	20,6	18,5	14,9	12,0	
		330			23,8	21,8	18,2	15,2		
		360			26,2	25,0	21,4	18,5		
		380				23,6	20,6			
		410			26,2	23,9				
		440			26,2	26,2				
$\phi 12$	37,7	140			11,1	7,1	4,5	3,5	2,2	1,6
		200			18,9	14,9	11,7	9,2	6,0	4,5
		260			26,7	22,7	19,5	17,0	12,7	9,5
		320			34,6	30,5	27,3	24,8	20,5	17,0
		350	37,7	37,7	34,4	31,2	28,7	24,4	20,9	
		380			35,1	32,6	28,3	24,8		
		400			37,7	35,3	30,9	27,4		
		420				33,5	30,0			
		460			37,7	35,2				
		480			37,7	37,7				
$\phi 14$	51,3	160			16,0	11,3	7,7	5,8	3,7	2,8
		220			25,1	20,4	16,7	13,8	9,2	6,9
		280			34,2	29,5	25,8	22,9	17,9	13,8
		340			43,3	38,6	34,9	32,0	27,0	22,8
		400	51,3	51,3	47,7	44,0	41,1	36,1	31,9	
		430			48,5	45,7	40,6	36,5		
		450			51,3	48,7	43,7	39,5		
		470				46,7	42,6			
		510			51,3	48,6				
		530			51,3	51,3				
$\phi 16$	67,0	180			21,8	16,4	12,1	9,1	6,0	4,4
		240			32,2	26,8	22,5	19,3	13,5	10,0
		300			42,6	37,2	32,9	29,7	23,9	19,2
		360			53,0	47,6	43,3	40,1	34,3	29,6
		450	67,0	67,0	63,2	58,9	55,7	49,9	45,2	
		480			64,1	60,9	55,1	50,4		
		500			67,0	64,3	58,6	53,8		
		520				62,0	57,3			
		550			67,0	62,5				
		580			67,0	67,0				
$\phi 20$	104,7	220			35,9	29,2	23,8	19,7	13,1	9,8
		280			48,9	42,2	36,8	32,7	25,5	19,7
		340			61,9	55,2	49,8	45,7	38,5	32,6
		400			74,9	68,2	62,8	58,8	51,5	45,6
		460	87,9	81,2	75,8	71,8	64,5	58,6		
		540	104,7	104,7	98,5	93,2	89,1	81,9	76,0	
		570			99,7	95,6	88,4	82,5		
		600			104,7	102,1	94,9	89,0		
		620				99,2	93,3			
		650			104,7	99,8				
680	104,7	104,7								

\*For additional values please check CSTB report n°26048096.

Characteristic yield strength  $f_{yk} = 500 \text{ N/mm}^2$

Steel failure

### b) Overlap joint application

Max. bond stress,  $f_{bd, FIRE}$ , depending on actual clear concrete cover for classifying the fire resistance. It must be verified that the actual force in the bar during a fire,  $F_{s, T}$ , can be taken up by the bar connection of the selected length,  $l_{inst}$ . Note: Cold design for ULS is mandatory.

$$F_{s, T} \leq (l_{inst} - c_f) \cdot \phi \cdot \pi \cdot f_{bd, FIRE} \quad \text{where: } (l_{inst} - c_f) \geq l_s;$$

$l_s$  = lap length

$\phi$  = nominal diameter of bar

$l_{inst} - c_f$  = selected overlap joint length; this must be at least  $l_s$ ,

but may not be assumed to be more than  $80 \phi$

$f_{bd, FIRE}$  = bond stress when exposed to fire

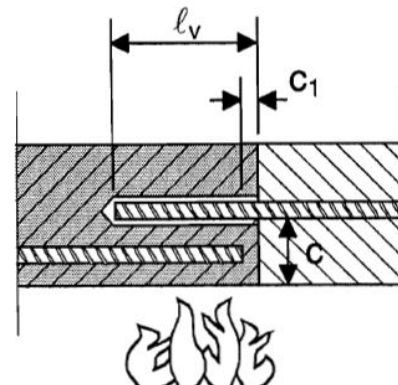

**Critical temperature-dependent bond stress,  $f_{bd, FIRE}$ , concerning “overlap joint” for Hilti HIT-CT 1 injection adhesive in relation to fire resistance class and required minimum concrete coverage  $c$ .**

Clear concrete cover $c$ [mm]	Max. bond stress, $\tau_c$ [N/mm <sup>2</sup> ]					
	R30	R60	R90	R120	R180	R240
20	0,4					
30	0,6					
40	0,9	0,5				
50	1,2	0,6	0,4			
60	1,6	0,8	0,5	0,4		
70	2,0	1,0	0,7	0,5	0,4	
80	2,6	1,3	0,9	0,6	0,4	0,4
90	3,2	1,5	1,0	0,8	0,5	0,4
100		1,8	1,2	0,9	0,6	0,5
110		2,2	1,4	1,1	0,7	0,5
120		2,6	1,7	1,3	0,9	0,6
130		3,0	1,9	1,4	1,0	0,7
140			2,2	1,6	1,1	0,9
150			2,5	1,8	1,2	1,0
160			2,9	2,1	1,4	1,1
170			3,3	2,4	1,5	1,2
180				2,7	1,7	1,3
190				3,0	1,9	1,4
200				3,3	2,1	1,6
210					2,3	1,7
220		3,5			2,6	1,9
230					2,8	2,0
240			3,5		3,1	2,2
250					3,3	2,4
260				3,5		2,6
270						2,8
280					3,5	3,1
290						3,3
300						3,5



## Materials

### Material quality

Part	Material
Rebar EN 1992-1-1	Bars and de-coiled rods class B or C with $f_{yk}$ and $k$ according to NDP or NCL of EN 1992-1-1 $f_{uk} = f_{tk} = k \cdot f_{yk}$

### Fitness for use

Some creep tests have been conducted in accordance with ETAG guideline 001 part 5 and TR 023 in the following conditions: **in dry environment at 50 °C during 90 days.**

These tests show an excellent behaviour of the post-installed connection made with HIT-CT 1: low displacements with long term stability, failure load after exposure above reference load.

### Resistance to chemical substances

Chemical	Resistance	Chemical	Resistance
Acetic acid 100%	o	Methanol 100%	o
Acetic acid 10%	+	Peroxide of hydrogen 30%	o
Hydrochloric Acid 20%	+	Solution of phenol (sat.)	-
Nitric Acid 40%	-	Sodium hydroxide pH=14	+
Phosphoric Acid 40%	+	Solution of chlorine (sat.)	+
Sulphuric acid 40%	+	Solution of hydrocarbons (60 % vol Toluene, 30 % vol Xylene, 10 % vol Methyl naphthalene)	+
Ethyl acetate 100%	o	Salted solution 10%	+
Acetone 100%	-	Sodium chloride	
Ammoniac 5%	o	Suspension of concrete (sat.)	+
Diesel 100%	+	Chloroform 100%	+
Gasoline 100%	+	Xylene 100%	+
Ethanol 96%	o		
Machine oils 100%	+		

- + resistant
- o resistant in short term (max. 48h) contact
- not resistant

### Electrical Conductivity

HIT-CT 1 in the hardened state **is not conductive electrically**. Its electric resistivity is  $1,4 \cdot 10^{10} \Omega \cdot m$  (DIN IEC 93 – 12.93). It is adapted well to realize electrically insulating anchoring (ex: railway applications, subway).

### Installation temperature range:

+5°C to +40°C

### Service temperature range

Hilti HIT-CT 1 injection mortar may be applied in the temperature ranges given below. An elevated base material temperature may lead to a reduction of the design bond resistance.

Temperature range	Base material temperature	Maximum long term base material temperature	Maximum short term base material temperature
Temperature range	-40 °C to +80 °C	+50°C	+80 °C



### Max short term base material temperature

Short-term elevated base material temperatures are those that occur over brief intervals, e.g. as result of diurnal cycling.

### Max long term base material temperature

Long-term elevated base material temperatures are roughly constant over significant periods of time.

### Working time and curing time <sup>1)</sup>

Temperature of the base material $T_{BM}$	Working time $t_{gel}$	Curing time $t_{cure}$
$-5\text{ °C} < t_{BM} < 0\text{ °C}$	60 min	6 h
$0\text{ °C} \leq t_{BM} < 5\text{ °C}$	40 min	3 h
$5\text{ °C} \leq t_{BM} < 10\text{ °C}$	25 min	2 h
$10\text{ °C} \leq t_{BM} < 20\text{ °C}$	10 min	90 min
$20\text{ °C} \leq t_{BM} < 30\text{ °C}$	4 min	75 min
$30\text{ °C} \leq t_{BM} < 40\text{ °C}$	2 min	60 min

1) The curing time data are valid for dry anchorage base only. For water saturated anchorage bases the curing times must be doubled.

### Setting information

#### Installation equipment

Rebar – size	$\phi 8$	$\phi 10$	$\phi 12$	$\phi 14$	$\phi 16$	$\phi 18$	$\phi 20$	$\phi 22$	$\phi 24$	$\phi 25$
Rotary hammer	TE2(-A) – TE30(-A)						TE40 – TE80			
Other tools	Blow out pump ( $h_{ef} \leq 10 \cdot d$ )						-			
	Compressed air gun <sup>a)</sup> Set of cleaning brushes <sup>b)</sup> , dispenser, piston plug									

a) Compressed air gun with extension hose for all drill holes deeper than 250 mm (for  $\phi 8$  to  $\phi 12$ ) or deeper than  $20 \cdot \phi$  (for  $\phi > 12$  mm)

b) Automatic brushing with round brush for all drill holes deeper than 250 mm (for  $\phi 8$  to  $\phi 12$ ) or deeper than  $20 \cdot \phi$  (for  $\phi > 12$  mm)

#### Minimum concrete cover $c_{min}$ of the post-installed rebar

Drilling method	Rebar – size [mm]	Minimum concrete cover $c_{min}$ [mm]		
		Without drilling aid	With drilling aid	
Hammer drilling (HD) and HD with Hilti hollow drill bit (HDB)	$\phi \leq 24$	$30 + 0,06 \cdot l_v \geq 2 \cdot \phi$	$30 + 0,02 \cdot l_v \geq 2 \cdot \phi$	
	$\phi = 25$	$40 + 0,06 \cdot l_v \geq 2 \cdot \phi$	$40 + 0,02 \cdot l_v \geq 2 \cdot \phi$	
Compressed air drilling (CA)	$\phi \leq 24$	$50 + 0,08 \cdot l_v$	$50 + 0,02 \cdot l_v$	
	$\phi = 25$	$60 + 0,08 \cdot l_v \geq 2 \cdot \phi$	$60 + 0,02 \cdot l_v \geq 2 \cdot \phi$	

### Drilling and cleaning parameters

Rebar	Hammer drilling (HD)	Hollow Drill Bit (HDB) <sup>a)</sup>	Compressed air drilling (CA)	Brush HIT-RB	Air nozzle HIT-RB
	d <sub>0</sub> [mm]			size [mm]	
φ8	10	-	-	10	-
	12	12	-	12	12
φ10	12	12	-	12	12
	14	14	-	14	14
φ12	14	14	-	14	14
	16	16	-	16	16
	-	-	17	18	16
φ14	18	18	-	18	18
	-	-	17	18	16
φ16	20	20	20	20	20
φ18	22	22	22	22	22
φ20	25	25	-	25	25
	-	-	26	28	25
φ22	28	28	28	28	28
φ24	32	32	32	32	32
φ25	32	32	32	32	32

a) No cleaning required

### Dispenser and corresponding maximum embedment depth $l_{v,max}$

Rebar – size [mm]	Dispenser (HDM 330, HDM 500, HDE 500)
	$l_{v,max}$ [mm]
φ8 - φ16	700
φ18 - φ25	500

## Setting instructions

\*For detailed information on installation see instruction for use given with the package of the product.



### Safety regulations.

Review the Material Safety Data Sheet (MSDS) before use for proper and safe handling! Wear well-fitting protective goggles and protective gloves when working with Hilti HIT-CT1.

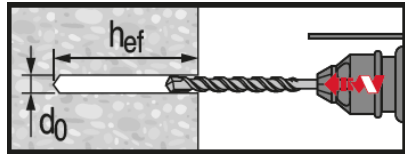

**Hammer drilled hole (HD)**

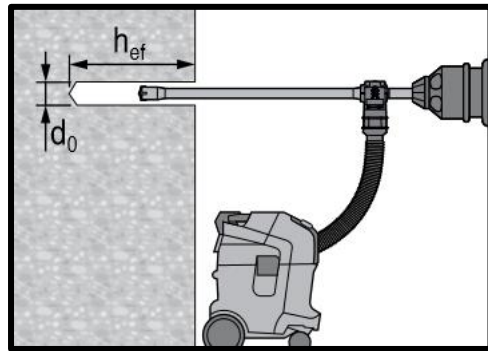

**Hammer drilled hole with Hollow drill bit (HDB)**

No cleaning required

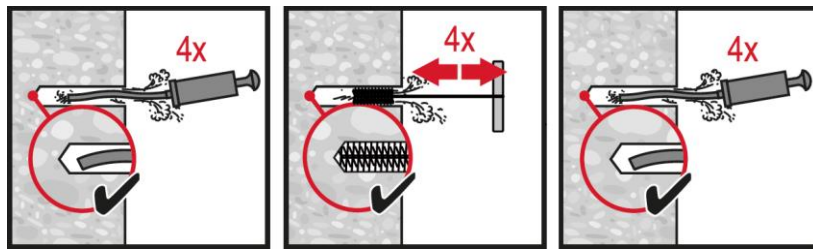

### Manual cleaning (MC)

for drill diameters  $d_0 \leq 20$  mm and drill hole depth  $h_0 \leq 10 \cdot d$ .

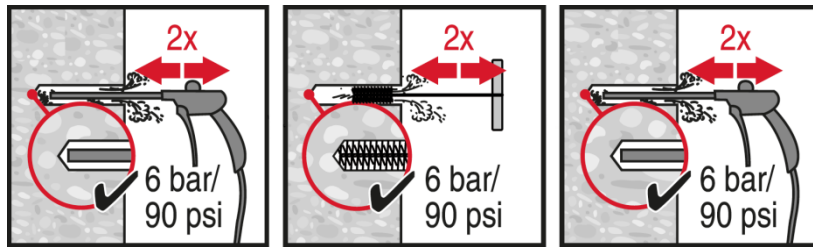

### Compressed air cleaning (CAC)

for all drill hole diameters  $d_0$  and drill hole depths  $h_0 \leq 20 \cdot d$ .

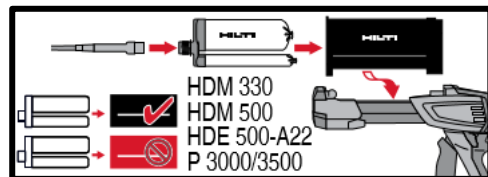

### Injection system preparation.

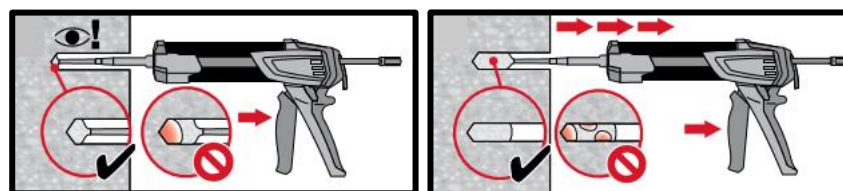
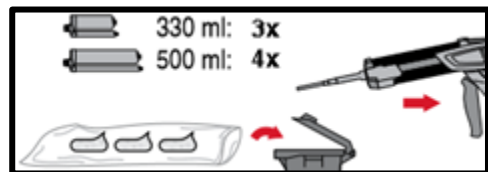

### Injection method for drill hole depth

$h_{ef} \leq 250$  mm.

Concrete  
Chemical anchors  
Mechanical anchors  
Plastic/Light duty metal anchors  
Insulation anchors

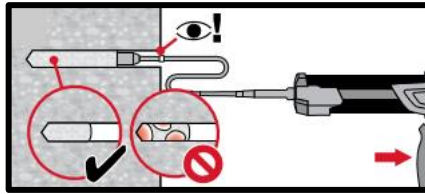
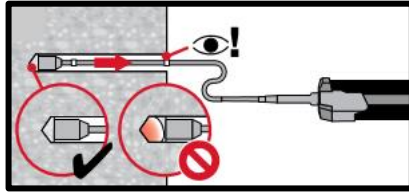

**Injection method for drill hole depth**  
 $h_{ef} > 250\text{mm}$ .

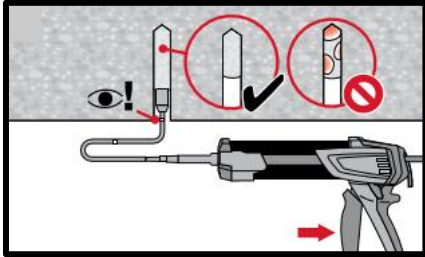
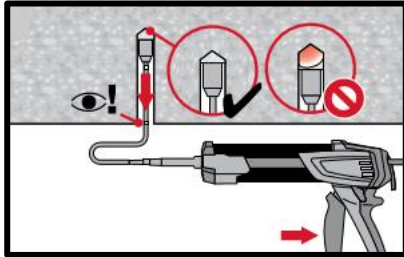

**Injection method for overhead application.**

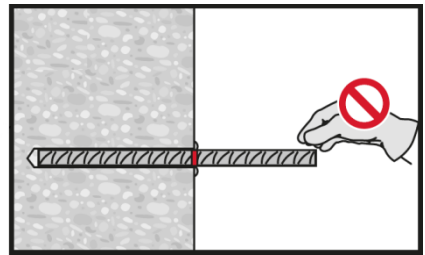
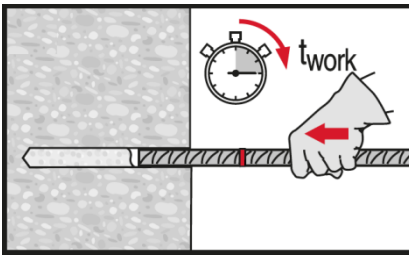

**Setting element, observe working time**  
 "t<sub>work</sub>".

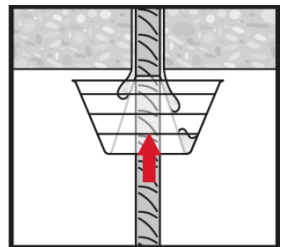
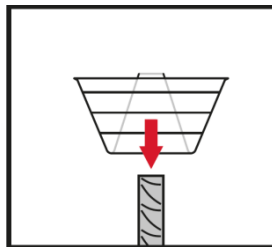
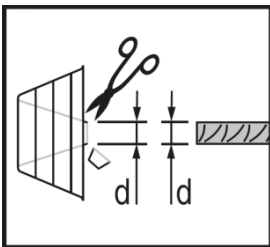

**Setting element for overhead applications, observe working time**  
 "t<sub>work</sub>".

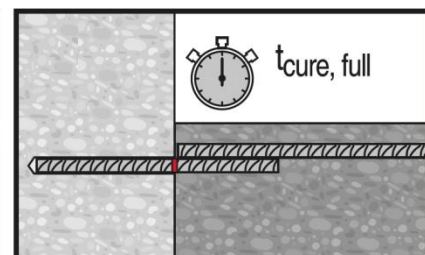
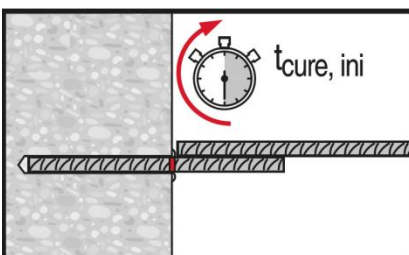
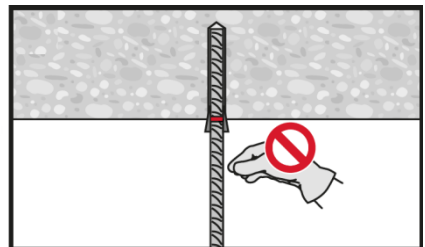
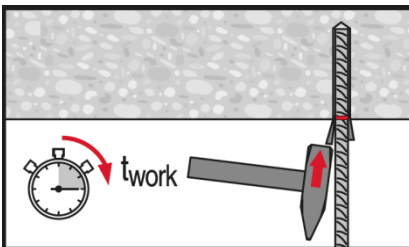

**Apply full load only after curing time**  
 "t<sub>cure</sub>".

# HIT-ICE injection mortar

Anchor design (ETAG 001) / Rods&Sleeves / Concrete

## Injection mortar system

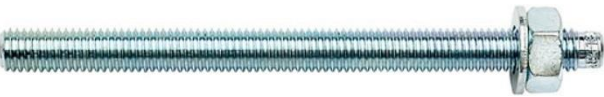

Hilti HIT-ICE  
296 ml cartridge

Anchor rod:  
HIT-V  
HIT-V-F  
HIT-V-R  
HIT-V-HCR rods  
(M8-M24)

Anchor rod:  
HAS-(E)  
HAS-(E)-R  
HAS-(E)-HCR rods  
(M8-M24)

Internally threaded  
sleeve:  
HIS-N  
HIS-R-N sleeves  
(M8-M20)

## Benefits

- Suitable for cracked <sup>a)</sup> and non-cracked concrete C 20/25 to C 50/60
- High loading capacity
- Suitable for dry and water saturated concrete
- High corrosion <sup>a)</sup> / corrosion resistant
- Odourless resin
- Low installation temperature

## Base material



Concrete (non-cracked)

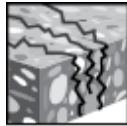

Concrete <sup>a)</sup> (cracked)

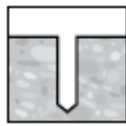

Dry concrete



Wet concrete

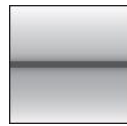

Static/  
quasi-static

## Load conditions

## Installation conditions



Hammer drilled holes

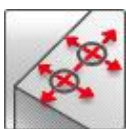

Small edge distance and spacing

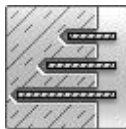

Variable embedment depth

a) Applications only for HIT-V rods.

## Other information



PROFIS  
Anchor design software

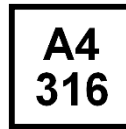

Corrosion resistance



High corrosion resistance <sup>a)</sup>

## Approvals / certificates

Description	Authority / Laboratory	No. / date of issue
Hilti Technical Data <sup>a)</sup>	Hilti	2017-11-28

a) All data given in this section according to Hilti Technical Data.

## Basic loading data (for a single anchor)

### All data in this section applies to

- Correct setting (See setting instruction)
- No edge distance and spacing influence
- Steel failure
- Base material thickness, as specified in the table
- One typical embedment depth, as specified in the table
- One anchor material, as specified in the tables
- Concrete C 20/25,  $f_{ck,cube} = 25 \text{ N/mm}^2$

### Embedment depth and base material thickness

Anchor size		M8	M10	M12	M16	M20	M24
<b>HIT-V</b>							
Typical embedment depth	[mm]	80	90	110	125	170	210
Base material thickness	[mm]	110	120	140	165	220	270
<b>HIS-N</b>							
Typical embedment depth	[mm]	90	110	125	170	205	-
Base material thickness	[mm]	120	150	170	230	270	-

### Characteristic resistance

Anchor size		M8	M10	M12	M16	M20	M24
<b>Non-cracked concrete</b>							
Tension $N_{Rk}$	HIT-V 5.8	17,6	29,0	42,0	66,0	96,1	142,5
	HIS-N 8.8	25,0	42,8	56,4	88,2	88,9	-
Shear $V_{Rk}$	HIT-V 5.8	9,0	15,0	21,0	39,0	61,0	88,0
	HIS-N 8.8	13,0	23,0	34,0	63,0	58,0	-
<b>Cracked concrete</b>							
Tension $N_{Rk}$	HIT-V 5.8	-	-	20,7	25,1	32,0	-
Shear $V_{Rk}$	HIT-V 5.8	-	-	21,0	39,0	61,0	-

### Design resistance

Anchor size		M8	M10	M12	M16	M20	M24
<b>Non-cracked concrete</b>							
Tension $N_{Rd}$	HIT-V 5.8	11,7	16,5	24,2	36,7	53,4	79,2
	HIS-N 8.8	16,7	28,5	37,6	58,8	59,3	-
Shear $V_{Rd}$	HIT-V 5.8	7,2	12,0	16,8	31,2	48,8	70,4
	HIS-N 8.8	10,4	18,4	27,2	50,4	46,4	-
<b>Cracked concrete</b>							
Tension $N_{Rd}$	HIT-V 5.8	-	-	11,5	14,0	17,8	-
Shear $V_{Rd}$	HIT-V 5.8	-	-	16,8	31,2	42,7	-

### Recommended loads <sup>a)</sup>

Anchor size		M8	M10	M12	M16	M20	M24
<b>Non-cracked concrete</b>							
Tension $N_{Rec}$	HIT-V 5.8	8,4	11,8	17,3	26,2	38,1	56,5
	HIS-N 8.8	11,9	20,4	26,8	42,0	42,3	-
Shear $V_{Rec}$	HIT-V 5.8	5,1	8,6	12,0	22,3	34,9	50,3
	HIS-N 8.8	7,4	13,1	19,4	36,0	33,1	-
<b>Cracked concrete</b>							
Tension $N_{Rec}$	HIT-V 5.8	-	-	8,2	10,0	12,7	-
Shear $V_{Rec}$	HIT-V 5.8	-	-	12,0	22,3	30,5	-

a) With overall partial safety factor for action  $\gamma=1,2$ . The partial safety factors for action depend on the type of loading and shall be taken from national regulations.



## Materials

### Mechanical properties for HIT-V / HAS

Anchor size		M8	M10	M12	M16	M20	M24
Nominal tensile strength $f_{uk}$	HIT-V 5.8 HAS-(E) 5.8	500	500	500	500	500	500
	HIT-V 8.8	800	800	800	800	800	800
	HIT-V-R HAS-(E)R	700	700	700	700	700	700
	HIT-V-HCR HAS-(E)HCR	800	800	800	800	800	700
Yield strength $f_{yk}$	HIT-V 5.8 HAS-(E) 5.8	400	400	400	400	400	400
	HIT-V 8.8	640	640	640	640	640	640
	HIT-V-R HAS-(E)R	450	450	450	450	450	450
	HIT-V-HCR HAS-(E)HCR	600	600	600	600	600	400
Stressed cross-section $A_s$	HIT-V	36,6	58,0	84,3	157	245	353
	HAS-(E)	32,8	52,3	76,2	144,0	225,0	324,0
Moment of resistance $W$	HIT-V	31,2	62,3	109,0	277,0	541,0	935,0
	HAS-(E)	27,0	54,1	93,8	244,0	474,0	809,0

### Mechanical properties for HIS-N

Anchor size		M8	M10	M12	M16	M20
Nominal tensile strength $f_{uk}$	HIS-N	490	490	460	460	460
	Screw 8.8	800	800	800	800	800
	HIS-RN	700	700	700	700	700
	Screw A4-70	700	700	700	700	700
Yield strength $f_{yk}$	HIS-N	410	410	375	375	375
	Screw 8.8	640	640	640	640	640
	HIS-RN	350	350	350	350	350
	Screw A4-70	450	450	450	450	450
Stressed cross-section $A_s$	HIS-(R)N	51,5	108,0	169,1	256,1	237,6
	Screw	36,6	58	84,3	157	245
Moment of resistance $W$	HIS-(R)N	145	430	840	1595	1543
	Screw	31,2	62,3	109	277	541



### Material quality for HIT-V

Part	Material
<b>Zinc coated steel</b>	
Threaded rod, HIT-V 5.8 (F) HAS-(E) 5.8	Strength class 5.8; Elongation at fracture A5 > 8% ductile Electroplated zinc coated $\geq 5\mu\text{m}$ ; (F) hot dip galvanized $\geq 45\mu\text{m}$
Threaded rod, HIT-V 8.8 (F) HAS-(E) 8.8	Strength class 8.8; Elongation at fracture A5 > 12% ductile Electroplated zinc coated $\geq 5\mu\text{m}$ ; (F) hot dip galvanized $\geq 45\mu\text{m}$
Washer	Electroplated zinc coated $\geq 5\mu\text{m}$ , hot dip galvanized $\geq 45\mu\text{m}$
Nut	Strength class of nut adapted to strength class of threaded rod. Electroplated zinc coated $\geq 5\mu\text{m}$ , hot dip galvanized $\geq 45\mu\text{m}$
<b>Stainless Steel</b>	
Threaded rod, HIT-V-R HAS-(E)-R	Strength class 70 for $\leq \text{M}24$ and strength class 50 for $> \text{M}24$ ; Elongation at fracture A5 > 8% ductile Stainless steel 1.4401; 1.4404; 1.4578; 1.4571; 1.4439; 1.4362
Washer	Stainless steel 1.4401, 1.4404, 1.4578, 1.4571, 1.4439, 1.4362 EN 10088-1:2014
Nut	Stainless steel 1.4401, 1.4404, 1.4578, 1.4571, 1.4439, 1.4362 EN 10088-1:2014
<b>High corrosion resistant steel</b>	
Threaded rod, HIT-V-HCR HAS-(E)-HCR	Strength class 80 for $\leq \text{M}20$ and class 70 for $> \text{M}20$ , Elongation at fracture A5 > 8% ductile High corrosion resistance steel 1.4529; 1.4565;
Washer	High corrosion resistant steel 1.4529, 1.4565 EN 10088-1:2014
Nut	High corrosion resistant steel 1.4529, 1.4565 EN 10088-1:2014

### Material quality for HIS-N

Part	Material	
HIS-N	Internally threaded sleeves	C-steel 1.0781 Steel galvanized $\geq 5\mu\text{m}$
	Screw 8.8	Strength class 8.8, A5 > 8% ductile Steel galvanized $\geq 5\mu\text{m}$
HIS-RN	Internally threaded sleeves	Stainless steel 1.4401 and 1.4571
	Screw A4-70	Strength 70, A5 > 8% ductile Stainless steel 1.4401, 1.4404, 1.4578, 1.4571, 1.4439, 1.4362

### Anchor dimension

Anchor size	M8	M10	M12	M16	M20	M24
HAS-(E), HAS-(E)-R, HAS-(E)-HCR	M8x80	M10x90	M12x110	M16x125	M20x170	M24x210
HIT-V, HIT-V-R, HIT-V-HCR	Anchor rods HIT-V (-R/-HCR) are available in variable length					
HIS-(R)N	M8x90	M10x90	M12x110	M16x125	M20x170	-

### Setting information

#### Installation temperature range:

-23°C to +32°C

#### In service temperature range

Hilti HIT-ICE injection mortar may be applied in the temperature ranges given below. An elevated base material temperature may lead to a reduction of the design bond resistance.

### Temperature in base material

Temperature range	Base material temperature	Max. long term base material temperature	Max. short term base material temperature
Temperature range I	-40 °C to + 40 °C	+ 24 °C	+ 40 °C
Temperature range II	-40 °C to + 54 °C	+ 43 °C	+ 54 °C

### Max. short term base material temperature

Short term elevated base material temperatures are those that occur over brief intervals, e.g. as a result of diurnal cycling.

### Max. long term base material temperature

Long term elevated base material temperatures are roughly constant over significant periods of time.

### Working time and curing time

Temperature of the base material	Curing time before anchor can be fully loaded $t_{cure}$	Working time in which anchor can be inserted and adjusted $t_{work}$
32 °C	35 min	1 min
21 °C	45 min	2,5 min
16 °C	1 h	5 min
4 °C	1,5 h	15 min
-7 °C	6 h	1 h
-18 °C	24 h	1,5 h
-23 °C	36 h	1,5 h

### Setting details

Anchor size	M8	M10	M12	M16	M20	M24
Nominal diameter of drill bit $d_0$ [mm]	10	12	14	18	24	28
Effective anchorage and drill hole depth $h_{ef}$ [mm]	60 to 160	60 to 200	70 to 240	80 to 320	90 to 400	96 to 480
Min. base material thickness <sup>a)</sup> $h_{min}$ [mm]	$h_{ef} + 30 \geq 100$ mm			$h_{ef} + 2 d_0$		
Diameter of clearance hole in the fixture $d_f$ [mm]	9	12	14	18	22	26
Minimum spacing $s_{min}$ [mm]	40	50	60	80	100	120
Minimum edge distance $c_{min}$ [mm]	40	45	45	50	55	60
Critical spacing for splitting failure $s_{cr,sp}$ [mm]	$2 C_{cr,sp}$					
Critical edge distance for splitting failure <sup>b)</sup> $c_{cr,sp}$ [mm]	$1,0 \cdot h_{ef}$ for $h / h_{ef} \geq 2,0$					
	$4,6 h_{ef} - 1,8 h$ for $2,0 > h / h_{ef} > 1,3$					
	$2,26 h_{ef}$ for $h / h_{ef} \leq 1,3$					
Critical spacing for concrete cone failure $s_{cr,N}$ [mm]	$2 C_{cr,N}$					
Critical edge distance for concrete cone failure <sup>b)</sup> $c_{cr,N}$ [mm]	$1,5 h_{ef}$					
Torque moment <sup>c)</sup> $T_{max}$ [Nm]	10	20	40	80	150	200

For spacing (edge distance) smaller than critical spacing (critical edge distance) the design loads have to be reduced.

- $h$ : base material thickness ( $h \geq h_{min}$ )
- The critical edge distance for concrete cone failure depends on the embedment depth  $h_{ef}$  and the design bond resistance. The simplified formula given in this table is on the same side.
- This is the maximum recommended torque moment to avoid splitting failure during installation for anchors with minimum spacing and / or edge distance.

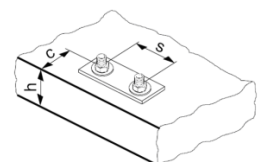
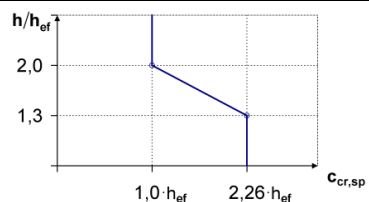

### Installation equipment

Anchor size		M8	M10	M12	M16	M20	M24
Rotary hammer	HIT-V	TE 2 – TE 30			TE 40 – TE 70		
	HIS-N	TE 2 – TE 30		TE 40 – TE 70		-	
Other tools		Compressed air gun or blow out pump					
		Set of cleaning brushes, dispenser					

### Drilling and cleaning parameters

HIT-V HAS	HIS-N	Hammer drill (HD)	Brush HIT-RB
		$d_0$ [mm]	size [mm]
M8	-	10	10
M10	-	12	12
M12	M8	14	14
M16	M10	18	18
-	M12	22	22
M20	-	24	24
M24	M16	28	28
M27	-	30	30
-	M20	32	32

### Setting instructions

\*For detailed information on installation see instruction for use given with the package of the product.



#### Safety regulations.

Review the Material Safety Data Sheet (MSDS) before use for proper and safe handling! Wear well-fitting protective goggles and protective gloves when working with Hilti HIT-ICE.

### Drilling

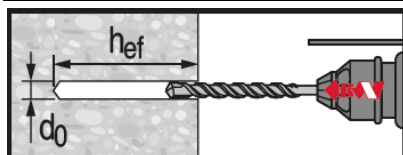

Hammer drilled hole (HD)

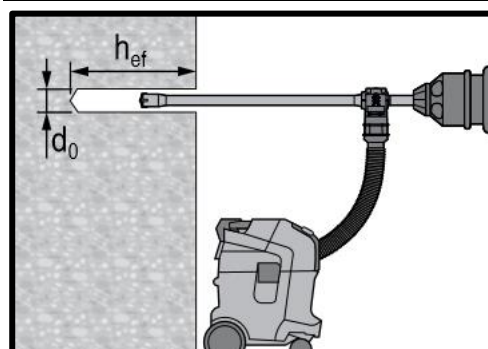

Hammer drilled hole with Hollow Drilled Bit (HDB)

No cleaning required.  
For dry and wet concrete, only.

## Cleaning

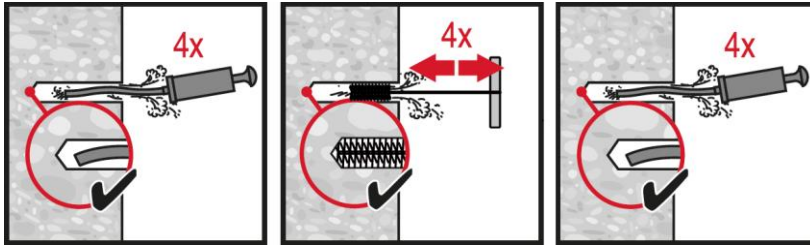

### Hammer Drilling:

#### Manual cleaning (MC)

for drill diameters  $d_0 \leq 16$  mm and drill hole depth  $h_0 \leq 10 \cdot d_0$ .

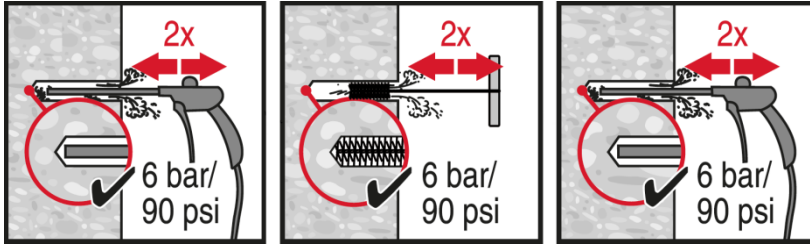

### Hammer Drilling:

#### Compressed air cleaning (CAC)

For all drill hole diameters  $d_0$  and all drill hole depths  $h_0$ .

## Injection system

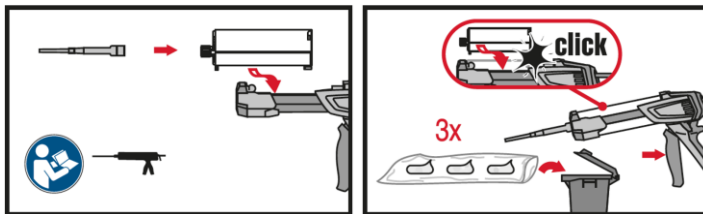

Injection system preparation.

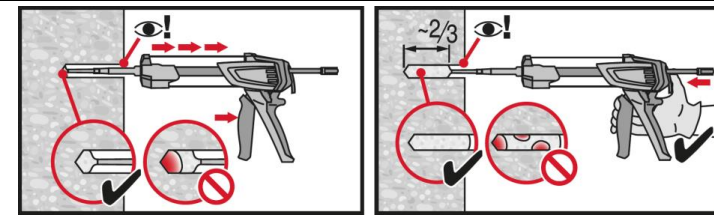

### Injection method for drill hole depth

$h_{ef} \leq 250$  mm.

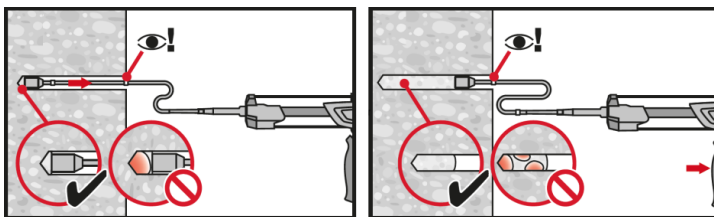

### Injection method for drill hole depth

$h_{ef} > 250$  mm.

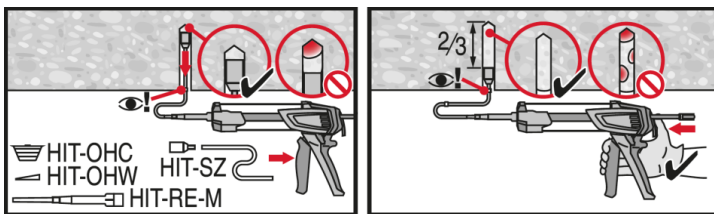

Injection method for overhead application.

## Setting the element

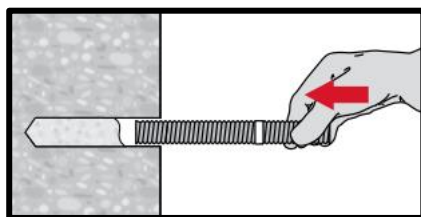

Setting element, observe working time " $t_{work}$ ".

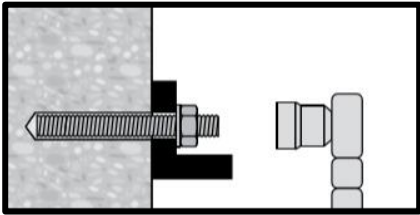

**Loading the anchor:** After required curing time  $t_{cure}$  the anchor can be loaded.

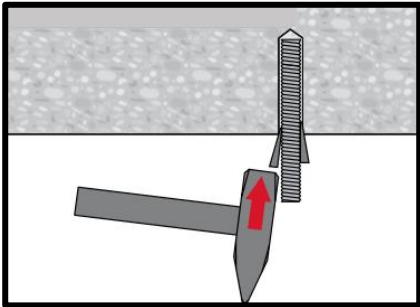

**Setting element for overhead applications,** observe working time " $t_{work}$ ".

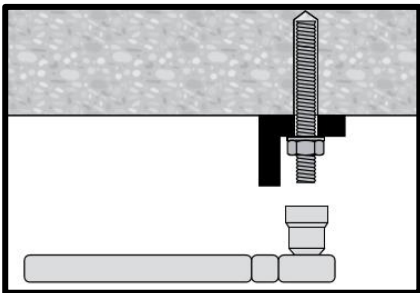

**Loading the anchor** after required curing time  $t_{cure}$  the anchor can be loaded.

Concrete

Chemical anchors

Mechanical anchors

Plastic/Light duty metal anchors

Insulation anchors

# HIT-ICE injection mortar

Anchor design (ETAG 001) / Rebar elements / Concrete

## Injection mortar system



Hilti HIT-ICE  
296 ml cartridge



Rebar B500 B  
(φ8 - φ25)

## Benefits

- Suitable for non-cracked concrete C20/25 to C50/60
- Suitable for dry and water saturated concrete
- High loading capacity
- High corrosion resistant
- Odourless resin
- Low installation temperature

## Base material



Concrete  
(non-cracked)



Dry concrete



Wet concrete

## Load condition

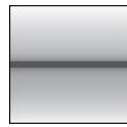

Static/  
quasi-static

## Installation conditions

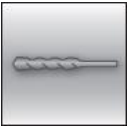

Hammer  
drilling

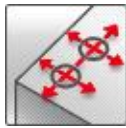

Small edge  
distance and  
spacing

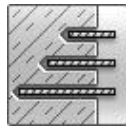

Variable  
embedment  
depth

## Other information



PROFIS  
Rebar design  
Software

## Approvals / certificates

Description	Authority / Laboratory	No. / date of issue
Hilti Technical Data <sup>a)</sup>	Hilti	2017-11-28

a) All data given in this section according to Hilti Technical Data.

### Basic loading data (for a single anchor)

#### All data in this section applies to

- Correct setting
- No edge distance and spacing influence
- Steel* failure
- Base material thickness, as specified in the table
- One typical embedment depth, as specified in the table
- One anchor material, as specified in the tables
- Concrete C20/25,  $f_{ck,cube} = 25 \text{ N/mm}^2$

#### Embedment depth and base material thickness for static and quasi-static loading data

Anchor- size		φ8	φ10	φ12	φ14	φ16	φ20	φ25
Typical embedment depth	$h_{ef}$ [mm]	80	90	110	125	125	170	210
Base material thickness	$h_{min}$ [mm]	110	120	145	165	165	220	275

#### Characteristic resistance for rebar B500 B

Anchor- size		φ8	φ10	φ12	φ14	φ16	φ20	φ25
Tensile $N_{Rk}$	[kN]	17,1	24,0	35,2	46,7	53,4	85,5	131,9
Shear $V_{Rk}$		14,0	22,0	31,0	42,0	55,0	86,0	135,0

#### Design resistance for rebar B500 B

Anchor- size		φ8	φ10	φ12	φ14	φ16	φ20	φ25
Tensile $N_{Rd}$	[kN]	9,5	13,4	19,6	26,0	29,7	47,5	73,3
Shear $V_{Rd}$		9,3	14,7	20,7	28,0	36,7	57,3	90,0

#### Recommended loads <sup>a)</sup> for rebar B500 B

Anchor- size		φ8	φ10	φ12	φ14	φ16	φ20	φ25
Tensile $N_{Rec}$	[kN]	6,8	9,5	14,0	18,5	21,2	33,9	52,4
Shear $V_{Rec}$		6,7	10,5	14,8	20,0	26,2	41,0	64,3

a) With overall partial safety factor for action  $\gamma=1,2$ . The partial safety factors for action depend on the type of loading and shall be taken from national regulations.

### Materials

#### Mechanical properties for rebar B500 B

Anchor size		φ8	φ10	φ12	φ14	φ16	φ20	φ25
Nominal tensile strength $f_{uk}$	[N/mm <sup>2</sup> ]	550	550	550	550	550	550	550
Yield strength $f_{yk}$	[N/mm <sup>2</sup> ]	500	500	500	500	500	500	500
Stressed cross-section $A_s$	[mm <sup>2</sup> ]	50,3	78,5	113,1	153,9	201,1	314,2	490,9
Moment of resistance $W$	[mm <sup>3</sup> ]	50,3	98,2	169,6	269,4	402,1	785,4	1534

#### Material quality

Part	Material
Rebar B500 B	Geometry and mechanical properties according to DIN 488-2:1986 or DIN 488-2



## Setting information

**Installation temperature range:**  
-23°C to +32°C

### Service temperature range

Hilti HIT-ICE injection mortar may be applied in the temperature ranges given below. An elevated base material temperature may lead to a reduction of the design bond resistance.

Temperature range	Base material temperature	Max. long term base material temperature	Max. short term base material temperature
Temperature range I	-40 °C to + 40 °C	+ 24 °C	+ 40 °C
Temperature range II	-40 °C to + 40 °C	+ 43 °C	+ 54 °C

### Max. short term base material temperature

Short term elevated base material temperatures are those that occur over brief intervals, e.g. as a result of diurnal cycling.

### Max. long term base material temperature

Long term elevated base material temperatures are roughly constant over significant periods of time.

### Working time and curing time

Temperature of the base material	Curing time before anchor can be fully loaded $t_{\text{cure}}$	Working time in which anchor can be inserted and adjusted $t_{\text{work}}$
32 °C	35 min	1 min
21 °C	45 min	2,5 min
16 °C	1 h	5 min
4 °C	1,5 h	15 min
-7 °C	6 h	1 h
-18 °C	24 h	1,5 h
-23 °C	36 h	1,5 h

1) The curing time data are valid for dry base material only. In wet material the curing times must be doubled.

### Installation equipment

Anchor size	Ø8	Ø10	Ø12	Ø14	Ø16	Ø20	Ø25
Rotary hammer	TE 2 – TE 16					TE 40 – TE 80	
Other tools	Compressed air gun, blow out pump Set of cleaning brushes, dispenser						

### Setting details

Anchor size		Ø8	Ø10	Ø12	Ø14	Ø16	Ø20	Ø25
Nominal diameter of drill bit $d_0$	[mm]	12	14	16	18	20	25	32
Effective anchorage and drill hole depth range <sup>a)</sup>	$h_{ef}$ [mm]	60 to 160	60 to 200	70 to 240	75 to 280	80 to 320	90 to 400	100 to 500
Minimum base material thickness	$h_{min}$ [mm]	$h_{ef} + 30 \text{ mm}$ $\geq 100 \text{ mm}$			$h_{ef} + 2 d_0$			
Minimum spacing	$s_{min}$ [mm]	40	50	60	70	80	100	125
Minimum edge distance	$c_{min}$ [mm]	40	50	60	70	80	100	125
Critical spacing for splitting failure	$s_{cr,sp}$ [mm]	$2 c_{cr,sp}$						
Critical edge distance for splitting failure <sup>b)</sup>	$c_{cr,sp}$ [mm]	$1,0 \cdot h_{ef}$ for $h / h_{ef} \geq 2,0$						
		$4,6 h_{ef} - 1,8 h$ for $2,0 > h / h_{ef} > 1,3$						
		$2,26 h_{ef}$ for $h / h_{ef} \leq 1,3$						
Critical spacing for concrete cone failure	$s_{cr,N}$ [mm]	$2 c_{cr,N}$						
Critical edge distance for concrete cone failure	$c_{cr,N}$ [mm]	$1,5 h_{ef}$						

For spacing (edge distance) smaller than critical spacing (critical edge distance) the design loads have to be reduced.

a)  $h$ : base material thickness ( $h \geq h_{min}$ )

b) The critical edge distance for concrete cone failure depends on the embedment depth  $h_{ef}$  and the design bond resistance. The simplified formula given in this table is on the safe side.

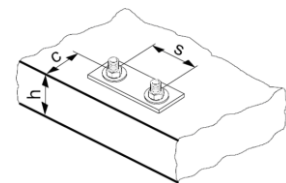
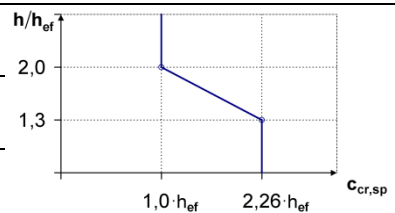

## Setting instructions

\*For detailed information on installation see instruction for use given with the package of the product.



### Safety regulations.

Review the Material Safety Data Sheet (MSDS) before use for proper and safe handling! Wear well-fitting protective goggles and protective gloves when working with Hilti HIT-ICE

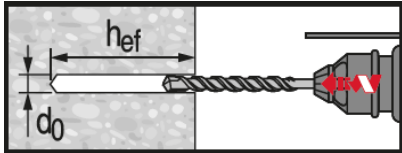

### Hammer drilled hole (HD)

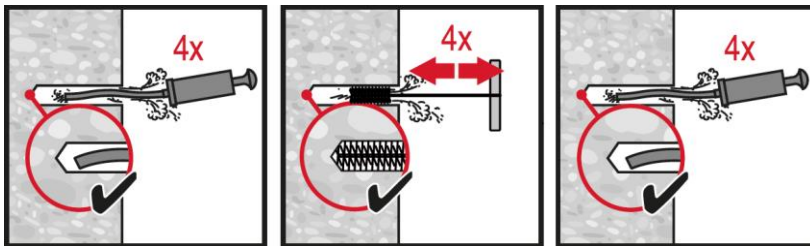

### Manual cleaning (MC)

For element sizes  $d \leq 16\text{mm}$  and embedment depth  $h_{ef} \leq 10d$  only.

Brush bore hole with required steel brush HIT-RB.

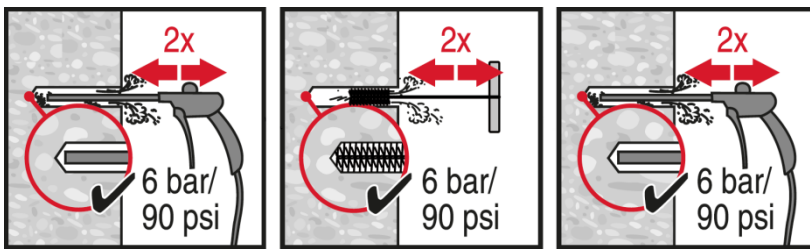

### Compressed air cleaning (CAC)

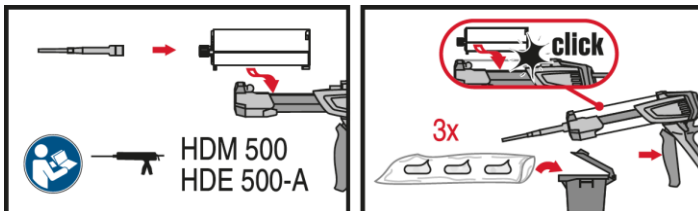

### Injection system preparation.

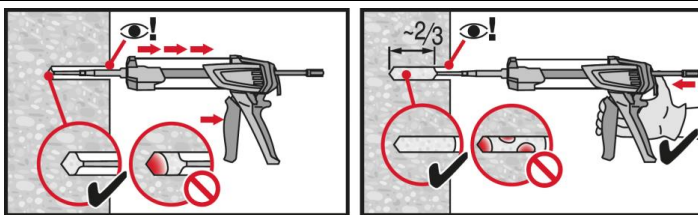

### Injection method for drill hole depth $h_{ef} > 250\text{mm}$

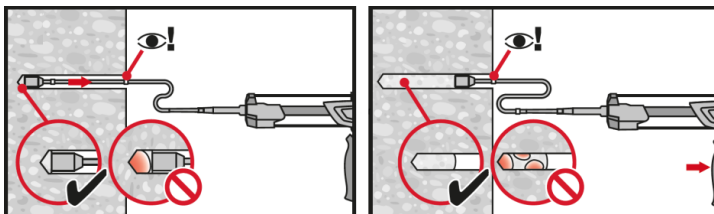

### Injection method for drill hole depth $h_{ef} > 250\text{mm}$ .

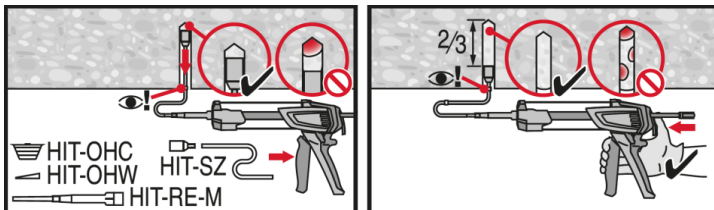

### Injection method for overhead application.

Concrete  
Chemical anchors  
Mechanical anchors  
Plastic/Light duty metal anchors  
Insulation anchors

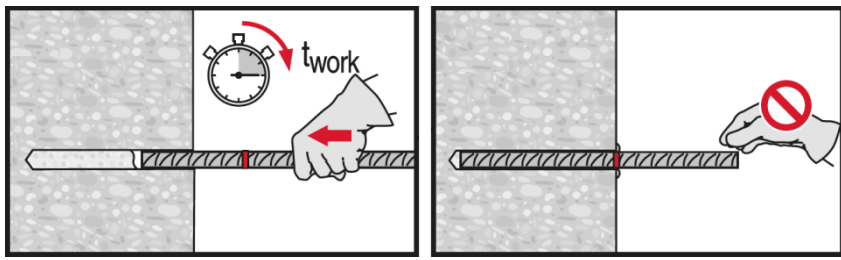

**Setting element**, observe working time "t<sub>work</sub>".

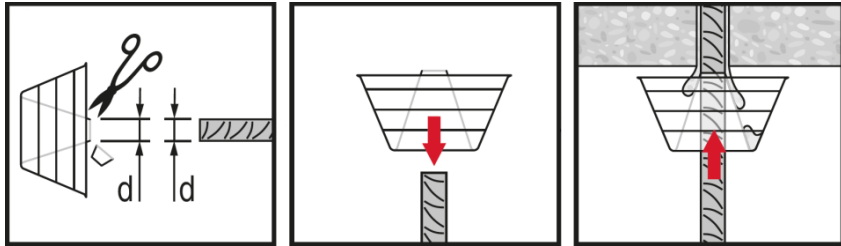

**Setting element** for overhead applications, observe working time "t<sub>work</sub>".

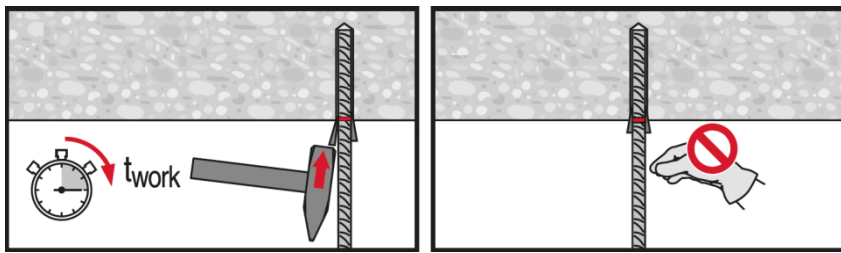

# HVZ (HVU-TZ+HAS-TZ) adhesive anchor system

Anchor design (ETAG 001) / Rods&Sleeves / Concrete

## Anchor version



HVZ  
Mortar capsule



Anchor rod:  
HAS-TZ  
HAS-R-TZ  
HAS-HCR-TZ  
(M10-M20)

## Benefits

- Suitable for cracked and non-cracked concrete C20/25 to C50/60
- High loading capacity
- Suitable for dry and water saturated concrete

## Base material



Concrete (non-cracked)



Concrete (cracked)



Dry concrete

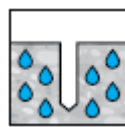

Wet concrete

## Load conditions

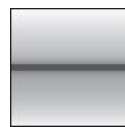

Static/  
quasi-static



Fire  
resistance

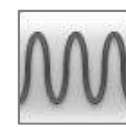

Fatigue



Shock

## Installation conditions

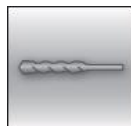

Hammer  
drilled  
holes

**SAFE-SET**

Hilti  
SafeSet  
technology

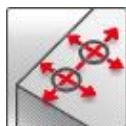

Small edge  
distance  
and  
spacing



European  
Technical  
Assessment



CE  
conformity

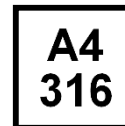

Corrosion  
resistance



High  
corrosion  
resistance



PROFIS  
design  
Software

## Other information

## Approvals / certificates

Description	Authority / Laboratory	No. / date of issue
European Technical Assessment <sup>a)</sup>	DIBt, Berlin	ETA-03/0032 / 2015-08-27
Approval for shockproof fastenings in civil defence installations	Federal Office for Civil Protection, Bern	BZS D 09-602 / 2009-10-28
Fatigue loading	DIBt, Berlin	Z-21.3-1692 / 2016-10-14
Fire test report ZTV – Tunnel	IBMB, Braunschweig	UB 3357/0550-2 / 2001-06-26
Fire test report	IMBM, Brunswick	UB 3357/0550-1 / 2001-04-17
Assessment report (fire)	Warringtonfire	WF 327804/B / 2013-07-10

a) All data given in this section according to ETA-03/0032, issue 2015-08-27.

## Static and quasi-static resistance (for a single anchor)

### All data in this section applies to:

- Correct setting (See setting instruction)
- No edge distance and spacing influence
- Steel failure
- Base material thickness, as specified in the table
- Embedment depth, as specified in the table
- One anchor material, as specified in the tables
- Concrete C 20/25,  $f_{ck,cube} = 25 \text{ N/mm}^2$
- Temperature range I  
(min. Base material temperature  $-40^\circ\text{C}$ , max. Long term/short term base material temperature:  $+50^\circ\text{C}/80^\circ\text{C}$ )

### Effective anchorage depth for static

Anchor size			M10	M12	M16		M20
Eff. Anchorage depth	$h_{ef}$	[mm]	75	95	105	125	170
Base material thickness	$h_{min}$	[mm]	150	190	210	250	340

### Characteristic resistance

Anchor size		M10x75	M12x95	M16x105	M16x125	M20x170
<b>Non-cracked concrete</b>						
Tension $N_{Rk}$	HAS-TZ	32,8	40,0	54,3	70,6	111,9
	HAS-RTZ, HAS-HCR-TZ	32,8	40,0	54,3	70,6	111,9
Shear $V_{Rk}$	HAS-TZ	18,0	27,0	51,0	51,0	88,0
	HAS-RTZ, HAS-HCR-TZ	20,0	30,0	56,0	56,0	98,0
<b>Cracked concrete</b>						
Tension $N_{Rk}$	HAS-TZ	23,4	33,3	38,7	50,3	79,8
	HAS-RTZ, HAS-HCR-TZ	23,4	33,3	38,7	50,3	79,8
Shear $V_{Rk}$	HAS-TZ	18,0	27,0	51,0	51,0	88,0
	HAS-RTZ, HAS-HCR-TZ	20,0	30,0	56,0	56,0	98,0

### Design resistance

Anchor size		M10x75	M12x95	M16x105	M16x125	M20x170
<b>Non-cracked concrete</b>						
Tension $N_{Rd}$	HAS-TZ	21,9	26,7	36,2	47,1	74,6
	HAS-RTZ, HAS-HCR-TZ	21,9	26,7	36,2	47,1	74,6
Shear $V_{Rd}$	HAS-TZ	14,4	21,6	40,8	40,8	70,4
	HAS-RTZ, HAS-HCR-TZ	16,0	24,0	44,8	44,8	78,4
<b>Cracked concrete</b>						
Tension $N_{Rd}$	HAS-TZ	15,6	22,2	25,8	33,5	53,2
	HAS-RTZ, HAS-HCR-TZ	15,6	22,2	25,8	33,5	53,2
Shear $V_{Rd}$	HAS-TZ	14,4	21,6	40,8	40,8	70,4
	HAS-RTZ, HAS-HCR-TZ	16,0	24,0	44,8	44,8	78,4

### Recommended loads <sup>a)</sup>

Anchor size		M10x75	M12x95	M16x105	M16x125	M20x170
<b>Non-cracked concrete</b>						
Tension $N_{Rec}$	HAS-TZ [kN]	15,6	19,0	25,9	33,6	53,3
	HAS-RTZ, HAS-HCR-TZ	15,6	19,0	25,9	33,6	53,3
Shear $V_{Rec}$	HAS-TZ [kN]	10,3	15,4	29,1	29,1	50,3
	HAS-RTZ, HAS-HCR-TZ	11,4	17,1	32,0	32,0	56,0
<b>Cracked concrete</b>						
Tension $N_{Rec}$	HAS-TZ [kN]	11,1	15,9	18,4	24,0	38,0
	HAS-RTZ, HAS-HCR-TZ	11,1	15,9	18,4	24,0	38,0
Shear $V_{Rec}$	HAS-TZ [kN]	10,3	15,4	29,1	29,1	50,3
	HAS-RTZ, HAS-HCR-TZ	11,4	17,1	32,0	32,0	56,0

a) With overall partial safety factor for action  $\gamma = 1,4$ . The partial safety factors for action depend on the type of loading and shall be taken from national regulations.

### Materials

#### Mechanical properties

Anchor size		M10x75	M12x95	M16x105	M16x125	M20x170
Nominal tensile strength $f_{uk}$	[N/mm <sup>2</sup> ]	800	800	800	800	800
Yield strength $f_{yk}$	[N/mm <sup>2</sup> ]	640	640	640	640	640
Stressed cross-section $A_s$	tension [mm <sup>2</sup> ]	44,2	63,6	113	113	227
	shear [mm <sup>2</sup> ]	50,3	73,9	141	141	245
Moment of resistance W	HVZ [mm <sup>3</sup> ]	50,3	89,6	236	236	541

#### Material quality

Part	Material
HAS-TZ	carbon steel, strength class 8.8
HAS-R-TZ	stainless steel 1.4401 and 1.4571
HAS-HCR-TZ	high corrosion resistance steel 1.4529 and 1.4547

### Setting information

#### Installation temperature range:

-5°C to +80°C

#### In service temperature range

Hilti HVZ adhesive anchor with anchor rod HAS-TZ may be applied in the temperature ranges given below. An elevated base material temperature may lead to a reduction of the design bond resistance.

Temperature range	Base material temperature	Maximum long term base material temperature	Maximum short term base material temperature
Temperature range I	-40 °C to +80 °C	+ 50°C	+ 80°C

#### Max short term base material temperature

Short-term elevated base material temperatures are those that occur over brief intervals, e.g. as a result of diurnal cycling.

#### Max long term base material temperature

Long-term elevated base material temperatures are roughly constant over significant periods of time.



## Curing time

Temperature of the base material	Release screwed on setting tool curing time $t_{rel}$	Full load curing time $t_{cure}$
$-5\text{ °C} \leq T_{BM} < 0\text{ °C}$	60 min	5 hour
$0\text{ °C} \leq T_{BM} < 10\text{ °C}$	30 min	1 hour
$10\text{ °C} \leq T_{BM} < 20\text{ °C}$	20 min	30 min
$20\text{ °C} \leq T_{BM} < 40\text{ °C}$	8 min	20 min

## Setting details

Anchor size		M10x75	M12x95	M16x105	M16x125	M20x170
Diameter of element	d [mm]	10	12	16	16	20
Nominal diameter of drill bit	$d_0$ [mm]	12	14	18	18	25
Effective anchorage depth	$h_{ef}$ [mm]	75	95	105	125	170
Drill hole depth	$h_1$ [mm]	90	110	125	145	195
Min. thickness of concrete member	$h_{min}^{a)}$ [mm]	150	190	210	250	340
Diameter of clearance hole in the fixture	$d_f$ [mm]	12	14	18	18	22
<b>Cracked concrete</b>						
Min. spacing	$s_{min}$ [mm]	50	60	70	70	80
Min. edge distance	$c_{min}$ [mm]	50	60	70	70	80
<b>Non-cracked concrete</b>						
Min. spacing	$s_{min}$ [mm]	50	60	70	70	80
Min. edge distance	$c_{min}$ [mm]	50	70	85	85	80
Critical spacing for splitting failure	$s_{cr,sp}$ [mm]	$2\ c_{cr,sp}$				
Critical edge distance for splitting failure <sup>a)</sup>	$c_{cr,sp}$ [mm]	$1,5 \cdot h_{ef}$				
Critical spacing for concrete cone failure	$s_{cr,N}$ [mm]	$2\ c_{cr,N}$				
Critical edge distance for concrete cone failure <sup>b)</sup>	$c_{cr,N}$ [mm]	$1,5\ h_{ef}$				
Torque moment <sup>c)</sup>	[Nm]	40	50	90	90	150

For spacing (edge distance) smaller than critical spacing (critical edge distance) the design loads have to be reduced.

a)  $h$ : base material thickness ( $h \geq h_{min}$ )

b) The critical edge distance for concrete cone failure depends on the embedment depth  $h_{ef}$  and the design bond resistance. The simplified formula given in this table is on the same side.

c) Max. recommended torque moment to avoid splitting failure during installation with min. spacing and/or edge distance

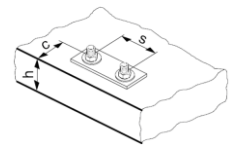

## Installation equipment

Anchor size	M10x75	M12x95	M16x105	M16x125	M20x170
Rotary hammer	TE 1 -TE 30		TE 1 – TE 60		TE 30 – TE 80
Tools	compressed air gun and blow out pump, set of cleaning brushes, dispenser				

## Drilling and cleaning parameters

HAS-TZ	Hammer drill	Hollow Drill Bit	Brush HIT-RB
	$d_0$ [mm]	size [mm]	
<b>M10</b>	10	-	10
<b>M12</b>	12	-	12
<b>M16</b>	16	16	16
<b>M20</b>	20	20	20

**Setting instructions**

\*For detailed information on installation see instruction for use given with the package of the product.



**Safety regulations.**

Review the Material Safety Data Sheet (MSDS) before use for proper and safe handling! Wear well-fitting protective goggles and protective gloves when working with Hilti HVZ.

**Hole drilling**

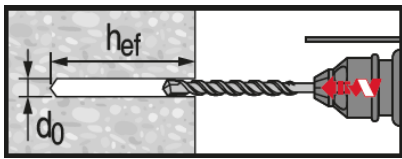

**Hammer drilled hole**

For dry or wet concrete and installation in flooded holes (no sea water).

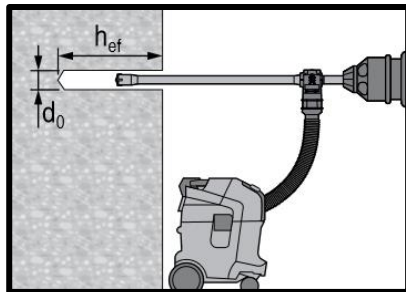

**Hammer drilled hole with Hollow drill bit**

For dry and wet concrete, only.  
No cleaning required.

**Hole cleaning**

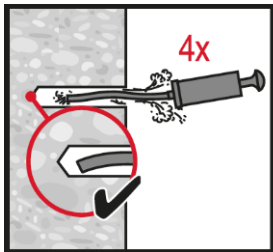

**Manual cleaning for hammer drilled hole**

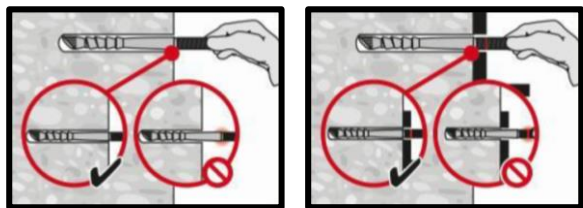

**Check the setting depth.**

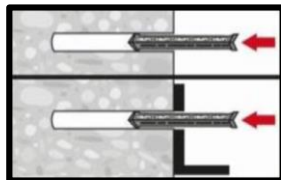

**Insert the foil capsule with the peak ahead to the back of the hole.**

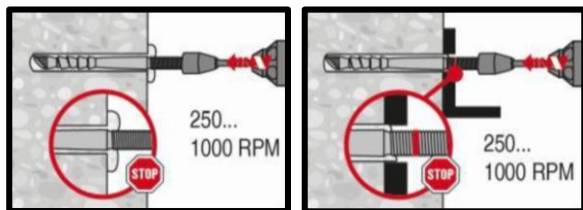

**Drive the anchor rod with the plugged tool into the hole.**

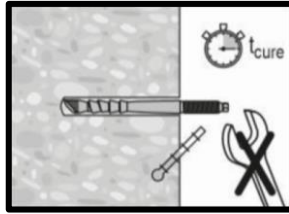
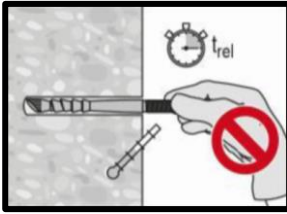

After **required time** remove the screwed on setting tool and excess mortar

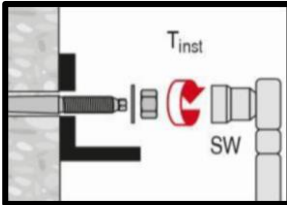

**Loading the anchor** after required curing time  $t_{cure}$  and apply installation torque

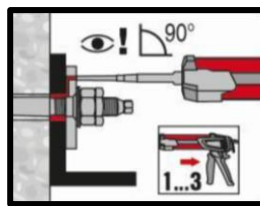
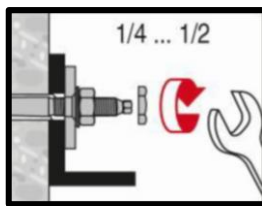
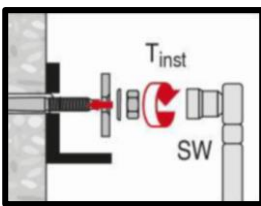

**Use of filling set.** Apply installation torque after required curing time, apply the lock nut and fill annular gap between anchor rod and picture

# HVU2 adhesive capsule

Anchor design (EN 1992-4) / Rods&Sleeves / Concrete

## Anchor version



HVU2  
Mortar capsule



Anchor rod:  
HAS-U  
HAS-U HDG  
HAS-U A4  
HAS-U HCR  
(M8-M30)



Internally threaded sleeve:  
HIS-N  
HIS-RN  
(M8-M20)

## Benefits

- **SafeSet** technology: Hilti hollow drill bit for automatic cleaning
- Suitable for cracked and non-cracked concrete C20/25 to C50/60 both for hammer drilled and diamond cored holes
- Highly reliable and safe anchor for seismic design with ETA C1/C2 approval. Seismic C1 ETA available even for Diamond cored holes.
- Clean and fast installation that suits hard jobsite conditions
- Suitable for dry and water saturated concrete
- High loading capacity
- Short curing time
- In service temperature range up to 120°C short term / 72°C long term

## Base material

## Load conditions



Concrete (non-cracked)



Concrete (cracked)

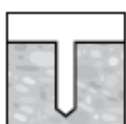

Dry concrete

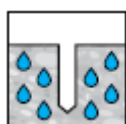

Wet concrete



Static/  
quasi-static



Fire  
resistance



Seismic  
ETA-C1/C2

## Installation conditions

## Other information

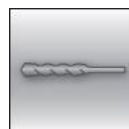

Hammer drilled holes



Diamond drilled holes

**SAFE-SET**

Hilti SafeSet technology

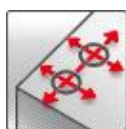

Small edge distance and spacing



European Technical Assessment



CE conformity



PROFIS design Software

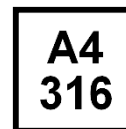

Corrosion resistance



High corrosion resistance

## Approvals / certificates

Description	Authority / Laboratory	No. / date of issue
European Technical Assessment <sup>a)</sup>	DIBt, Berlin	ETA-16/0515 / 2019-06-17
Fire test assessment	ING.Thiele, Pirmasens	21735 / 2017-08-01

a) All data given in this section according to ETA-16/0515, issue 2019-06-17.

## Static and quasi-static resistance (for a single anchor)

### All data in this section applies to:

- Correct setting (See setting instructions)
- No edge distance and spacing influence
- Steel failure
- Minimum base material thickness
- Concrete C20/25,  $f_{ck,cube} = 25 \text{ N/mm}^2$
- Temperature range I:  $-40 \text{ °C}$  to  $+40 \text{ °C}$   
(max. long term temperature  $+24 \text{ °C}$  and max. short term temperature  $+40 \text{ °C}$ )
- All data given in this section according ETA-16/0515, issue 2019-06-17.
- Short term loading. For long term loading please apply  $\psi_{sus}$ .  
Hammer drilled holes and Hammer drilled holes with Hollow Drill Bit:  $\psi_{sus} = 1.00$   
Diamond cored holes:  $\psi_{sus} = 0.78$

### Embedment depth and base material thickness

Anchor size	M8	M10	M12	M16	M20	M24	M27	M30
<b>HAS-U</b>								
Eff. Anchorage depth $h_{ef}$ [mm]	80	90	110	125	170	210	240	270
Base material thickness $h_{min}$ [mm]	110	120	140	160	220	270	300	340
<b>HIS-N</b>								
Eff. Anchorage depth $h_{ef}$ [mm]	90	110	125	170	205	-	-	-
Base material thickness $h_{min}$ [mm]	120	150	170	230	270	-	-	-

### Hammer drilled holes and hammer drilled holes with hollow drill bit<sup>1)</sup>:

#### Characteristic resistance

Anchor size	M8	M10	M12	M16	M20	M24	M27	M30	
<b>Non-cracked concrete</b>									
Tension $N_{Rk}$	HAS-U 5.8	18,3	29,0	42,2	68,8	109	150	-	-
	HAS-U 8.8	24,1	42,0	56,8	68,8	109	150	183	218
	HAS-U A4	24,1	40,6	56,8	68,8	109	150	183	218
	HAS-U HCR	24,1	42,0	56,8	68,8	109	150	-	-
	HIS-N 8.8	25,0	46,0	67,0	109	116	-	-	-
	HIS-RN 70	26,0	41,0	59,0	109	144	-	-	-
Shear $V_{Rk}$	HAS-U 5.8	9,2	14,5	21,1	39,3	61,3	88,3	-	-
	HAS-U 8.8	14,6	23,2	33,7	62,8	98,0	141	184	224
	HAS-U A4	12,8	20,3	29,5	55,0	85,8	124	115	140
	HAS-U HCR	14,6	23,2	33,7	62,8	98,0	124	-	-
	HIS-N 8.8	13,0	23,0	34,0	63,0	58,0	-	-	-
	HIS-RN 70	13,0	20,0	30,0	55,0	83,0	-	-	-
<b>Cracked concrete</b>									
Tension $N_{Rk}$	HAS-U 5.8	10,1	24,0	35,2	48,1	76,3	105	-	-
	HAS-U 8.8	10,1	24,0	35,2	48,1	76,3	105	128	153
	HAS-U A4	10,1	24,0	35,2	48,1	76,3	105	128	153
	HAS-U HCR	10,1	24,0	35,2	48,1	76,3	105	-	-
	HIS-N 8.8	23,0	37,1	48,1	76,3	101	-	-	-
	HIS-RN 70	23,0	37,1	48,1	76,3	101	-	-	-
Shear $V_{Rk}$	HAS-U 5.8	9,2	14,5	21,1	39,3	61,3	88,3	-	-
	HAS-U 8.8	14,6	23,2	33,7	62,8	98,0	141	184	224
	HAS-U A4	12,8	20,3	29,5	55,0	85,8	124	115	140
	HAS-U HCR	14,6	23,2	33,7	62,8	98,0	124	-	-
	HIS-N 8.8	13,0	23,0	34,0	63,0	58,0	-	-	-
	HIS-RN 70	13,0	20,0	30,0	55,0	83,0	-	-	-

1) Hilti hollow drill bit is available for the element sizes M12 to M30.

**Design resistance**

Anchor size		M8	M10	M12	M16	M20	M24	M27	M30
<b>Non-cracked concrete</b>									
Tension $N_{Rd}$	HAS-U 5.8	12,2	19,3	28,1	45,8	72,7	99,8	-	-
	HAS-U 8.8	16,1	28,0	37,8	45,8	72,7	99,8	122	145
	HAS-U A4	15,3	24,2	35,1	45,8	72,7	99,8	80,2	98,1
	HAS-U HCR	16,1	28,0	37,8	45,8	72,7	99,8	-	-
	HIS-N 8.8	16,7	30,7	44,7	72,7	77,3	-	-	-
	HIS-RN 70	13,9	21,9	31,6	58,8	69,2	-	-	-
Shear $V_{Rd}$	HAS-U 5.8	7,3	11,6	16,9	31,4	49,0	70,6	-	-
	HAS-U 8.8	11,7	18,6	27,0	50,2	78,4	113	147	180
	HAS-U A4	9,2	14,5	21,1	39,3	55,0	79,2	48,2	58,9
	HAS-U HCR	11,7	18,6	27,0	50,2	78,4	70,6	-	-
	HIS-N 8.8	10,4	18,4	27,2	50,4	46,4	-	-	-
	HIS-RN 70	8,3	12,8	19,2	35,3	41,5	-	-	-
<b>Cracked concrete</b>									
Tension $N_{Rd}$	HAS-U 5.8	6,7	16,0	23,5	32,1	50,9	69,9	-	-
	HAS-U 8.8	6,7	16,0	23,5	32,1	50,9	69,9	85,4	102
	HAS-U A4	6,7	16,0	23,5	32,1	50,9	69,9	80,2	98,1
	HAS-U HCR	6,7	16,0	23,5	32,1	50,9	69,9	-	-
	HIS-N 8.8	15,3	24,7	32,1	50,9	67,4	-	-	-
	HIS-RN 70	13,9	21,9	31,6	50,9	67,4	-	-	-
Shear $V_{Rd}$	HAS-U 5.8	7,3	11,6	16,9	31,4	49,0	70,6	-	-
	HAS-U 8.8	11,7	18,6	27,0	50,2	78,4	113	147	180
	HAS-U A4	9,2	14,5	21,1	39,3	55,0	79,2	48,2	58,9
	HAS-U HCR	11,7	18,6	27,0	50,2	78,4	70,6	-	-
	HIS-N 8.8	10,4	18,4	27,2	50,4	46,4	-	-	-
	HIS-RN 70	8,3	12,8	19,2	35,3	41,5	-	-	-

1) Hilti hollow drill bit is available for the element sizes M12 to M30.

**Recommended loads<sup>2)</sup>**

Anchor size		M8	M10	M12	M16	M20	M24	M27	M30
<b>Non-cracked concrete</b>									
Tension $N_{Rec}$	HAS-U 5.8	8,7	13,8	20,1	32,7	51,9	71,3	-	-
	HAS-U 8.8	11,5	20,0	27,0	32,7	51,9	71,3	87,1	104
	HAS-U A4	10,9	17,3	25,1	32,7	51,9	71,3	57,3	70,1
	HAS-U HCR	11,5	20,0	27,0	32,7	51,9	71,3	-	-
	HIS-N 8.8	11,9	21,9	31,9	51,9	55,2	-	-	-
	HIS-RN 70	9,9	15,7	22,5	42,0	49,4	-	-	-
Shear $V_{Rec}$	HAS-U 5.8	5,2	8,3	12,0	22,4	35,0	50,4	-	-
	HAS-U 8.8	8,4	13,3	19,3	35,9	56,0	80,7	105	128
	HAS-U A4	6,5	10,4	15,1	28,0	39,3	56,6	34,4	42,1
	HAS-U HCR	8,4	13,3	19,3	35,9	56,0	50,4	-	-
	HIS-N 8.8	7,4	13,1	19,4	36,0	33,1	-	-	-
	HIS-RN 70	6,0	9,2	13,7	25,2	29,6	-	-	-
<b>Cracked concrete</b>									
Tension $N_{Rec}$	HAS-U 5.8	4,8	11,4	16,8	22,9	36,3	49,9	-	-
	HAS-U 8.8	4,8	11,4	16,8	22,9	36,3	49,9	61,0	72,7
	HAS-U A4	4,8	11,4	16,8	22,9	36,3	49,9	57,3	70,1
	HAS-U HCR	4,8	11,4	16,8	22,9	36,3	49,9	-	-
	HIS-N 8.8	10,9	17,6	22,9	36,3	48,1	-	-	-
	HIS-RN 70	9,9	15,7	22,5	36,3	48,1	-	-	-
Shear $V_{Rec}$	HAS-U 5.8	5,2	8,3	12,0	22,4	35,0	50,4	-	-
	HAS-U 8.8	8,4	13,3	19,3	35,9	56,0	80,7	105	128
	HAS-U A4	6,5	10,4	15,1	28,0	39,3	56,6	34,4	42,1
	HAS-U HCR	8,4	13,3	19,3	35,9	56,0	50,4	-	-
	HIS-N 8.8	7,4	13,1	19,4	36,0	33,1	-	-	-
	HIS-RN 70	6,0	9,2	13,7	25,2	29,6	-	-	-

1) Hilti hollow drill bit is available for the element sizes M12-M30.

2) With overall partial safety factor for action  $\gamma = 1,4$ . The partial safety factors for action depend on the type of loading and shall be taken from national regulations.



**Diamond cored holes:**
**Characteristic resistance**

Anchor size		M8	M10	M12	M16	M20	M24	M27	M30
<b>Non-cracked concrete</b>									
Tension $N_{Rk}$	HAS-U 5.8	-	29,0	42,2	68,8	109	150	-	-
	HAS-U 8.8	-	39,6	56,8	68,8	109	150	183	218
	HAS-U A4	-	39,6	56,8	68,8	109	150	183	218
	HAS-U HCR	-	39,6	56,8	68,8	109	150	-	-
	HIS-N 8.8	25,0	46,0	67,0	109	116	-	-	-
	HIS-RN 70	26,0	41,0	59,0	109	144	-	-	-
Shear $V_{Rk}$	HAS-U 5.8	-	14,5	21,1	39,3	61,3	88,3	-	-
	HAS-U 8.8	-	23,2	33,7	62,8	98,0	141	184	224
	HAS-U A4	-	20,3	29,5	55,0	85,8	124	115	140
	HAS-U HCR	-	23,2	33,7	62,8	98,0	124	-	-
	HIS-N 8.8	13,0	23,0	34,0	63,0	58,0	-	-	-
	HIS-RN 70	13,0	20,0	30,0	55,0	83,0	-	-	-
<b>Cracked concrete</b>									
Tension $N_{Rk}$	HAS-U 5.8	-	19,8	29,0	44,0	74,8	105	-	-
	HAS-U 8.8	-	19,8	29,0	44,0	74,8	105	128	153
	HAS-U A4	-	19,8	29,0	44,0	74,8	105	128	153
	HAS-U HCR	-	19,8	29,0	44,0	74,8	105	-	-
	HIS-N 8.8	15,9	25,7	36,2	61,0	80,0	-	-	-
	HIS-RN 70	15,9	25,7	36,2	61,0	80,0	-	-	-
Shear $V_{Rk}$	HAS-U 5.8	-	14,5	21,1	39,3	61,3	88,3	-	-
	HAS-U 8.8	-	23,2	33,7	62,8	98,0	141	184	224
	HAS-U A4	-	20,3	29,5	55,0	85,8	124	115	140
	HAS-U HCR	-	23,2	33,7	62,8	98,0	124	-	-
	HIS-N 8.8	13,0	23,0	34,0	63,0	58,0	-	-	-
	HIS-RN 70	13,0	20,0	30,0	55,0	83,0	-	-	-

**Design resistance**

Anchor size		M8	M10	M12	M16	M20	M24	M27	M30
<b>Non-cracked concrete</b>									
Tension $N_{Rd}$	HAS-U 5.8	-	19,3	28,1	45,8	72,7	99,8	-	-
	HAS-U 8.8	-	26,4	37,8	45,8	72,7	99,8	122	145
	HAS-U A4	-	24,2	35,1	45,8	72,7	99,8	80,2	98,1
	HAS-U HCR	-	26,4	37,8	45,8	72,7	99,8	-	-
	HIS-N 8.8	16,7	30,7	44,7	72,7	77,3	-	-	-
	HIS-RN 70	13,9	21,9	31,6	58,8	69,2	-	-	-
Shear $V_{Rd}$	HAS-U 5.8	-	11,6	16,9	31,4	49,0	70,6	-	-
	HAS-U 8.8	-	18,6	27,0	50,2	78,4	113	147	180
	HAS-U A4	-	14,5	21,1	39,3	55,0	79,2	48,2	58,9
	HAS-U HCR	-	18,6	27,0	50,2	78,4	70,6	-	-
	HIS-N 8.8	10,4	18,4	27,2	50,4	46,4	-	-	-
	HIS-RN 70	8,3	12,8	19,2	35,3	41,5	-	-	-
<b>Cracked concrete</b>									
Tension $N_{Rd}$	HAS-U 5.8	-	13,2	19,4	29,3	49,8	69,9	-	-
	HAS-U 8.8	-	13,2	19,4	29,3	49,8	69,9	85,4	102
	HAS-U A4	-	13,2	19,4	29,3	49,8	69,9	80,2	98,1
	HAS-U HCR	-	13,2	19,4	29,3	49,8	69,9	-	-
	HIS-N 8.8	10,6	17,1	24,2	40,7	53,3	-	-	-
	HIS-RN 70	10,6	17,1	24,2	40,7	53,3	-	-	-
Shear $V_{Rd}$	HAS-U 5.8	-	11,6	16,9	31,4	49,0	70,6	-	-
	HAS-U 8.8	-	18,6	27,0	50,2	78,4	113	147	180
	HAS-U A4	-	14,5	21,1	39,3	55,0	79,2	48,2	58,9
	HAS-U HCR	-	18,6	27,0	50,2	78,4	70,6	-	-
	HIS-N 8.8	10,4	18,4	27,2	50,4	46,4	-	-	-
	HIS-RN 70	8,3	12,8	19,2	35,3	41,5	-	-	-



**Recommended loads <sup>a)</sup>**

Anchor size		M8	M10	M12	M16	M20	M24	M27	M30
<b>Non-cracked concrete</b>									
Tension $N_{Rec}$	HAS-U 5.8	-	13,8	20,1	32,7	51,9	71,3	-	-
	HAS-U 8.8	-	18,8	27,0	32,7	51,9	71,3	87,1	104
	HAS-U A4	-	17,3	25,1	32,7	51,9	71,3	57,3	70,1
	HAS-U HCR	-	18,8	27,0	32,7	51,9	71,3	-	-
	HIS-N 8.8	11,9	21,9	31,9	51,9	55,2	-	-	-
	HIS-RN 70	9,9	15,7	22,5	42,0	49,4	-	-	-
Shear $V_{Rec}$	HAS-U 5.8	-	8,3	12,0	22,4	35,0	50,4	-	-
	HAS-U 8.8	-	13,3	19,3	35,9	56,0	80,7	105	128
	HAS-U A4	-	10,4	15,1	28,0	39,3	56,6	34,4	42,1
	HAS-U HCR	-	13,3	19,3	35,9	56,0	50,4	-	-
	HIS-N 8.8	7,4	13,1	19,4	36,0	33,1	-	-	-
	HIS-RN 70	6,0	9,2	13,7	25,2	29,6	-	-	-
<b>Cracked concrete</b>									
Tension $N_{Rec}$	HAS-U 5.8	-	9,4	13,8	20,9	35,6	49,9	-	-
	HAS-U 8.8	-	9,4	13,8	20,9	35,6	49,9	61,0	72,7
	HAS-U A4	-	9,4	13,8	20,9	35,6	49,9	57,3	70,1
	HAS-U HCR	-	9,4	13,8	20,9	35,6	49,9	-	-
	HIS-N 8.8	7,6	12,2	17,3	29,1	38,1	-	-	-
	HIS-RN 70	7,6	12,2	17,3	29,1	38,1	-	-	-
Shear $V_{Rec}$	HAS-U 5.8	-	8,3	12,0	22,4	35,0	50,4	-	-
	HAS-U 8.8	-	13,3	19,3	35,9	56,0	80,7	105	128
	HAS-U A4	-	10,4	15,1	28,0	39,3	56,6	34,4	42,1
	HAS-U HCR	-	13,3	19,3	35,9	56,0	50,4	-	-
	HIS-N 8.8	7,4	13,1	19,4	36,0	33,1	-	-	-
	HIS-RN 70	6,0	9,2	13,7	25,2	29,6	-	-	-

a) With overall partial safety factor for action  $\gamma = 1,4$ . The partial safety factors for action depend on the type of loading and shall be taken from national regulations.

## Seismic resistance

### All data in this section applies to:

- Hammer drilled holes and hammer drilled holes with hollow drill bit
- Correct setting (See setting instructions)
- No edge distance and spacing influence
- *Steel* failure
- Minimum base material thickness
- Concrete C20/25,  $f_{ck,cube} = 25 \text{ N/mm}^2$
- $\alpha_{gap} = 0,5$  if no clearance hole was filled
- Temperature range I:  $-40 \text{ °C}$  to  $+40 \text{ °C}$   
(max. long term temperature  $+24 \text{ °C}$  and max. short term temperature  $+40 \text{ °C}$ )
- All data given in this section according ETA-16/0515, issue 2019-06-17

### Embedment depth and base material thickness

Anchor size	M8	M10	M12	M16	M20	M24	M27	M30
<b>HAS-U</b>								
Eff. Anchorage depth $h_{ef}$ [mm]	80	90	110	125	170	210	240	270
Base material thickness $h_{min}$ [mm]	110	120	140	160	220	270	300	340

### Characteristic resistance

Anchor size	M8	M10	M12	M16	M20	M24	M27	M30	
<b>Seismic performance C1</b>									
Tension $N_{Rk,seis}$ [kN]	HAS-U 5.8	-	24,0	33,8	40,9	64,9	89,1	-	-
	HAS-U 8.8	-	24,0	33,8	40,9	64,9	89,1	109	130
	HAS-U A4	-	24,0	33,8	40,9	64,9	89,1	109	130
	HAS-U HCR	-	24,0	33,8	40,9	64,9	89,1	-	-
Shear $V_{Rk,seis}$ [kN]	HAS-U 5.8	-	11,0	15,0	27,0	43,0	62,0	-	-
	HAS-U 8.8	-	16,0	24,0	44,0	69,0	99,0	129	157
	HAS-U A4	-	14,0	21,0	39,0	60,0	87,0	81,0	98,0
	HAS-U HCR	-	16,0	24,0	44,0	69,0	87,0	-	-
<b>Seismic performance C2</b>									
Tension $N_{Rd,seis}$ HAS-U 8.8	-	-	-	18,2	27,8	-	-	-	
Shear $V_{Rd,seis}$ HAS-U 8.8	-	-	-	40,0	71,0	-	-	-	

### Design resistance

Anchor size	M8	M10	M12	M16	M20	M24	M27	M30	
<b>Seismic performance C1</b>									
Tension $N_{Rd,seis}$ [kN]	HAS-U 5.8	-	16,0	22,5	27,3	43,3	59,4	-	-
	HAS-U 8.8	-	16,0	22,5	27,3	43,3	59,4	72,6	86,6
	HAS-U A4	-	16,0	22,5	27,3	43,3	59,4	72,6	86,6
	HAS-U HCR	-	16,0	22,5	27,3	43,3	59,4	-	-
Shear $V_{Rd,seis}$ [kN]	HAS-U 5.8	-	8,8	12,0	21,6	34,4	49,6	-	-
	HAS-U 8.8	-	12,8	19,2	35,2	55,2	79,2	103	126
	HAS-U A4	-	10,0	15,0	27,9	38,5	55,8	34,0	41,2
	HAS-U HCR	-	12,8	19,2	35,2	55,2	49,7	-	-
<b>Seismic performance C2</b>									
Tension $N_{Rd,seis}$ HAS-U 8.8	-	-	-	12,1	18,5	-	-	-	
Shear $V_{Rd,seis}$ HAS-U 8.8	-	-	-	32,0	56,8	-	-	-	

## Fire resistance

### All data in this section applies to:

- Correct setting (See setting instruction)
- No edge distance and spacing influence
- Steel failure
- Minimum base material thickness
- Concrete C20/25,  $f_{ck,cube} = 25 \text{ N/mm}^2$
- All data given in this section according to Fire test assessment from Ing. Thiele, Pirmasens 21735 / 2017-08-01

### Embedment depth and base material thickness

Anchor size		M8	M10	M12	M16	M20	M24	M27	M30
<b>HAS</b>									
Eff. Anchorage depth	$h_{ef}$ [mm]	80	90	110	125	170	210	240	270
Base material thickness	$h_{min}$ [mm]	110	120	140	160	220	270	300	340
<b>HIS-N</b>									
Eff. Anchorage depth	$h_{ef}$ [mm]	90	110	125	170	205	-	-	-
Base material thickness	$h_{min}$ [mm]	120	150	170	230	270	-	-	-

### Characteristic/design<sup>1</sup> resistance in uncracked concrete

Anchor size		M8	M10	M12	M16	M20	M24	M27	M30
<b>Fire Exposure R30</b>									
Tension $N_{Rk,fi}$	HAS-U 8.8	1,83	2,90	4,22	7,85	12,2	17,6	23,0	28,0
	HAS-U A4	4,19	6,64	9,65	17,1	28,0	40,4	52,5	64,2
	HIS-N 8.8	1,83	2,90	4,22	7,85	12,2	-	-	-
	HIS-RN 70	4,19	6,64	9,65	18,0	28,0	-	-	-
Shear $V_{Rk,fi}$	HAS-U 8.8	1,83	2,90	4,22	7,85	12,2	17,6	23,0	28,0
	HAS-U A4	4,19	6,64	9,65	17,1	28,0	40,4	52,5	64,2
	HIS-N 8.8	1,83	2,90	4,22	7,85	12,2	-	-	-
	HIS-RN 70	4,19	6,64	9,65	18,0	28,0	-	-	-
<b>Fire Exposure R120</b>									
Tension $N_{Rk,fi}$	HAS-U 8.8	0,28	0,47	1,31	2,22	4,41	6,35	8,26	10,1
	HAS-U A4	0,28	0,47	1,31	2,22	7,11	10,2	13,3	16,3
	HIS-N 8.8	0,43	1,02	1,52	2,83	4,41	-	-	-
	HIS-RN 70	0,43	1,02	1,75	4,55	7,11	-	-	-
Shear $V_{Rk,fi}$	HAS-U 8.8	0,28	0,47	1,31	2,22	4,41	6,35	8,26	10,1
	HAS-U A4	0,28	0,47	1,31	2,22	7,11	10,2	13,3	16,3
	HIS-N 8.8	0,43	1,02	1,52	2,83	4,41	-	-	-
	HIS-RN 70	0,43	1,02	1,75	4,55	7,11	-	-	-

1) The safety factor is  $\gamma=1.0$  for all load cases

**Characteristic/design<sup>1</sup> resistance in cracked concrete**

Anchor size		M8	M10	M12	M16	M20	M24	M27	M30	
<b>Fire Exposure R30</b>										
Tension $N_{Rk,fi}$	HAS-U 8.8	[kN]	-	2,90	4,22	7,85	12,2	16,6	23,0	28,0
	HAS-U A4		-	5,00	9,00	12,8	28,0	40,4	52,5	64,2
	HIS-N 8.8		1,83	2,90	4,22	7,85	12,2	-	-	-
	HIS-RN 70		4,19	6,64	9,65	18,00	28,0	-	-	-
Shear $V_{Rk,fi}$	HAS-U 8.8	[kN]	-	2,90	4,22	7,85	12,2	16,6	23,0	28,0
	HAS-U A4		-	5,00	9,00	12,8	28,0	40,4	52,5	64,2
	HIS-N 8.8		1,83	2,90	4,22	7,85	12,2	-	-	-
	HIS-RN 70		4,19	6,64	9,65	18,00	28,0	-	-	-
<b>Fire Exposure R120</b>										
Tension $N_{Rk,fi}$	HAS-U 8.8	[kN]	-	0,35	0,99	1,66	4,40	6,35	8,26	10,1
	HAS-U A4		-	0,35	1,00	1,66	6,90	10,2	13,3	16,3
	HIS-N 8.8		0,33	0,76	1,30	2,80	4,40	-	-	-
	HIS-RN 70		0,33	0,76	1,31	4,55	7,11	-	-	-
Shear $V_{Rk,fi}$	HAS-U 8.8	[kN]	-	0,35	0,99	1,66	4,40	6,35	8,26	10,1
	HAS-U A4		-	0,35	1,00	1,66	6,90	10,2	13,3	16,3
	HIS-N 8.8		0,33	0,76	1,30	2,80	4,40	-	-	-
	HIS-RN 70		0,33	0,76	1,31	4,55	7,11	-	-	-

1) The safety factor is  $\gamma=1.0$  for all load cases

**Materials**
**Mechanical properties for HAS-U**

Anchor size		M8	M10	M12	M16	M20	M24	M27	M30
Nominal tensile strength $f_{uk}$	HAS-U 5.8	500	500	500	500	500	500	-	-
	HAS-U 8.8	800	800	800	800	800	800	800	800
	HAS-U A4	700	700	700	700	700	700	500	500
	HAS-U HCR	800	800	800	800	800	700	-	-
Yield strength $f_{yk}$	HAS-U 5.8	440	440	440	440	400	400	-	-
	HAS-U 8.8	640	640	640	640	640	640	640	640
	HAS-U A4	450	450	450	450	450	450	210	210
	HAS-U HCR	640	640	640	640	640	400	-	-
Stressed cross-section $A_s$	HAS-U	36,6	58,0	84,3	157	245	353	459	561
Moment of resistance $W$	HAS-U	31,2	62,3	109	277	541	935	1387	1874

**Mechanical properties for HIS-N**

Anchor size		M8	M10	M12	M16	M20
Nominal tensile strength $f_{uk}$	HIS-N	490	490	490	490	490
	Screw 8.8	800	800	800	800	800
	HIS-RN	700	700	700	700	700
	Screw 70	700	700	700	700	700
Yield strength $f_{yk}$	HIS-N	390	390	390	390	390
	Screw 8.8	640	640	640	640	640
	HIS-RN	350	350	350	350	350
	Screw 70	450	450	450	450	450
Stressed cross-section $A_s$	HIS-(R)N	51,5	108	169	256	238
	Screw	36,6	58,0	84,3	157	245
Moment of resistance $W$	HIS-(R)N	145	430	840	1595	1543
	Screw	31,2	62,3	109	277	541

### Material quality for HAS-U

Part	Material
<b>Metal parts made of zinc coated steel</b>	
HAS-U	M8 to M24 Strength class 5.8: - Rupture elongation ( $l_0 = 5d$ ) > 8% ductile M8 to M30: Strength class 8.8: - Rupture elongation ( $l_0 = 5d$ ) > 12% ductile Electroplated zinc coated $\geq 5 \mu\text{m}$ ; (F) hot dip galvanized $\geq 45 \mu\text{m}$
Washer	Electroplated zinc coated $\geq 5 \mu\text{m}$ ; hot dip galvanized $\geq 45 \mu\text{m}$
Nut	Strength class adapted to strength class of threaded rod. Electroplated zinc coated $\geq 5 \mu\text{m}$ ; hot dip galvanized $\geq 45 \mu\text{m}$
<b>Metal parts made of stainless steel</b>	
HAS-U A4	M8 to M24 Strength class 70: M27 to M30 Strength class 50: - Rupture elongation ( $l_0=5d$ ) > 8% ductile - Stainless steel A4 according to EN 10088-1:2014
Washer	Stainless steel A4 according to EN 10088-1:2014
Nut	Strength class adapted to strength class of threaded rod. Stainless steel A4 according to EN 10088-1:2014
<b>Metal parts made of high corrosion resistant steel</b>	
HAS-U HCR	M8 to M20 Strength class 70: M24 Strength class 80: Rupture elongation ( $l_0 = 5d$ ) > 8% ductile High corrosion resistant steel according to EN 10088-1:2014
Washer	High corrosion resistant steel according to EN 10088-1:2014
Nut	Strength class adapted to strength class of threaded rod High corrosion resistant steel according to EN 10088-1:2014

### Material quality for HIS-N

Part	Material	
<b>Metal parts made of zinc coated steel</b>		
HIS-N	Internal threaded sleeve	Electroplated zinc coated $\geq 5 \mu\text{m}$
	Screw 8.8	Strength class 8.8, A5 > 8 % Ductile Steel galvanized $\geq 5 \mu\text{m}$
<b>Metal parts made of stainless steel</b>		
HIS-RN	Internal threaded sleeve	Stainless steel A4 according to EN 10088-1:2014
	Screw 70	Strength class 70, A5 > 8 % Ductile Stainless steel 1.4401; 1.4404, 1.4578; 1.4571; 1.4439; 1.4362

## Setting information

### Installation temperature range:

-10°C to +40°C for the standard variation of temperature and rapid variation of temperature after installation.

### In service temperature range

Hilti HVU2 adhesive may be applied in the temperature ranges given below. An elevated base material temperature may lead to a reduction of the design bond resistance.

Temperature range	Base material temperature	Maximum long term base material temperature	Maximum short term base material temperature
Temperature range I	-40 °C to +40 °C	+24 °C	+40 °C
Temperature range II	-40 °C to +80 °C	+50 °C	+80 °C
Temperature range III	-40 °C to +120 °C	+72 °C	+120 °C

### Max short term base material temperature

Short-term elevated base material temperatures are those that occur over brief intervals, e.g. as a result of diurnal cycling.

### Max long term base material temperature

Long-term elevated base material temperatures are roughly constant over significant periods of time.

### Curing time

Temperature of the base material	Minimum curing time $t_{cure}$
-10 °C to -6 °C	5 hours
-5 °C to -1 °C	3 hours
0 °C to 4 °C	40 min
5 °C to 9 °C	20 min
10 °C to 19 °C	10 min
20 °C to 40 °C	5 min



### Setting details for HAS-U

Anchor size		M8	M10	M12	M16	M20	M24	M27	M30	
<b>Foil capsule HVU2</b>		<b>8x80</b>	<b>10x90</b>	<b>12x110</b>	<b>16x125</b>	<b>20x170</b>	<b>24x210</b>	<b>27x240</b>	<b>30x270</b>	
Diameter of element	$d_1=d_{nom}$ [mm]	8	10	12	16	20	24	27	30	
Nom. diameter of drill	$d_0$ [mm]	10	12	14	18	22	28	30	35	
Eff. Embedment depth and drill hole in the fixture	$h_{ef}=h_0$ [mm]	80	90	110	125	170	210	240	270	
Max. diameter of clearance hole in the fixture	$d_f$ [mm]	9	12	14	18	22	26	30	33	
Min. thickness of concrete member	$h_{min}$ [mm]	110	120	140	160	220	270	300	340	
Max. torque moment <sup>a)</sup>	$T_{max}$ [Nm]	10	20	40	80	150	200	270	300	
Min. spacing	$s_{min}$ [mm]	40	50	60	75	90	115	120	140	
Min. edge distance	$c_{min}$ [mm]	40	45	45	50	55	60	75	80	
Critical spacing for splitting failure	$s_{cr,sp}$	$2 c_{cr,sp}$								
Critical edge distance for splitting failure <sup>b)</sup>	$c_{cr,sp}$ [mm]	$1,0 \cdot h_{ef}$		for $h / h_{ef} \geq 2,0$						
		$4,6 h_{ef} - 1,8 h$		for $2,0 > h/h_{ef} > 1,3$						
		$2,26 h_{ef}$		for $h / h_{ef} \leq 1,3$						
Critical spacing for concrete cone failure	$s_{cr,N}$ [mm]	$2 c_{cr,N}$						$3 h_{ef}$		
Critical edge distance for concrete cone	$c_{cr,N}$ [mm]	$1,5 h_{ef}$								

For spacing (edge distance) smaller than critical spacing (critical edge distance) the design loads have to be reduced.

- a) Max. recommended torque moment to avoid splitting failure during installation with min. spacing and/or edge distance
- b) h: base material thickness ( $h \geq h_{min}$ )
- c) The critical edge distance for concrete cone failure depends on the embedment depth  $h_{ef}$  and the design bond resistance. The simplified formula given in this table is on the save side.

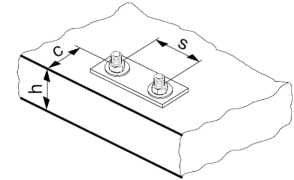

### HAS-U...



### Marking:

Steel grade number and length identification letter: e.g. 8L

### Setting details for HIS-N

Anchor size	M8	M10	M12	M16	M20
Foil capsule HVU2	10x90	12x110	16x125	20x170	24x210
Diameter of element $d_1=d_{nom}$ [mm]	12,5	16,5	20,5	25,4	27,8
Nominal diameter of drill bit $d_0$ [mm]	14	18	22	28	32
Eff. Embedment depth and drill hole in fixture $h_{ef}=h_0$ [mm]	90	110	125	170	205
Max. diameter of clearance hole in the $d_f$ [mm]	9	12	14	18	22
Min. thickness of concrete member $h_{min}$ [mm]	120	150	170	230	270
Max. torque moment <sup>a)</sup> $T_{max}$ [Nm]	10	20	40	80	150
Thread engagement $h_s$ [mm]	8-20	10-25	12-30	16-40	20-50
Min. spacing $s_{min}$ [mm]	60	75	90	115	130
Min. edge distance $c_{min}$ [mm]	40	45	55	65	90
Critical spacing for $s_{cr,sp}$	$2 c_{cr,sp}$				
Critical edge distance for splitting failure <sup>b)</sup> $c_{cr,sp}$ [mm]	$1,0 \cdot h_{ef}$		for $h / h_{ef} \geq 2,0$		
	$4,6 h_{ef} - 1,8 h$		for $2,0 > h/h_{ef} > 1,3$		
	$2,26 h_{ef}$		for $h / h_{ef} \leq 1,3$		
Critical spacing for concrete cone failure $s_{cr,N}$ [mm]	$2 c_{cr,N}$				$1,5 h_{ef}$
Critical edge distance for concrete cone $c_{cr,N}$ [mm]	$1,5 h_{ef}$				

For spacing (edge distance) smaller than critical spacing (critical edge distance) the design loads have to be reduced.

- a) Max. recommended torque moment to avoid splitting failure during installation with min. spacing and/or edge distance
- b)  $h$ : base material thickness ( $h \geq h_{min}$ )
- c) The critical edge distance for concrete cone failure depends on the embedment depth  $h_{ef}$  and the design bond resistance. The simplified formula given in this table is on the safe side.

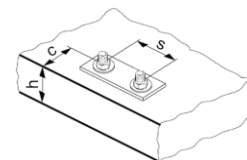

#### Internally threaded sleeve HIS-(R)N...

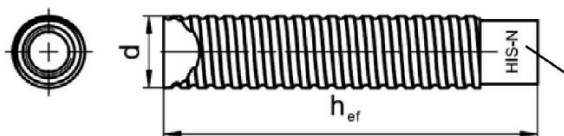

**Marking:**  
 Identifying mark - HILTI and  
 embossing "HIS-N" (for zinc coated steel)  
 embossing "HIS-RN" (for stainless steel)

### Drilling and cleaning parameters

HAS-U	HIS-N	Hammer drilling	Hollow Drill Bit	Diamond coring	Brush HIT-RB
		d <sub>0</sub> [mm]			size [mm]
M8	-	10	-	-	-
M10	-	12	-	12	12
M12	M8	14	14	14	14
M16	M10	18	18	18	18
M20	M12	22	22	22	22
M24	M16	28	28	28	28
M27	-	30	-	30	30
-	M20	32	32	32	32
M30	-	35	35	35	35

### Setting tools parameters

HAS	HIS-N	TE (A)	SID 4 A-22	SIW 22T-A	SF(H)	RPM
M8	-	1...7	+	+	2, 6, 8, 10, 14, 22	450...1300
M10	M8	1...7	+	+	6, 8, 10, 14, 22	450...1300
M12	M10	1...40	+	+	6, 8, 10, 14, 22	450...1300
M16	M12	1...40	+	-	6, 8, 10, 14, 22	450...1300
M20	-	50...60	-	-	-	-
-	M16	40...80	-	-	-	-
M24	-	50...80	-	-	-	-
-	M20	40...80	-	-	-	-
M27	-	60...80	-	-	-	-
M30	-	60...80	-	-	-	-

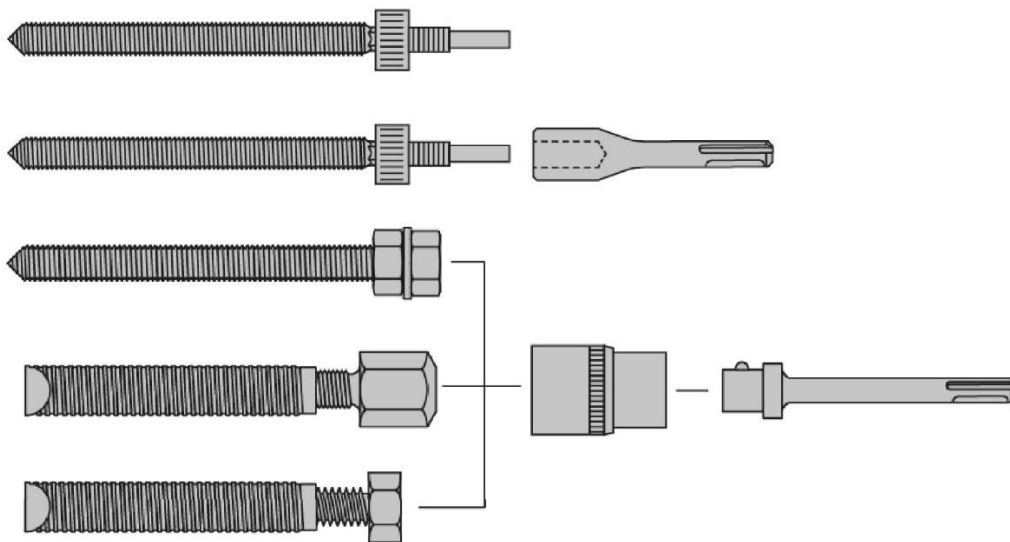

Setting tool	Article number	TE (A) 1...40	TE 50...80	SF (H)	SID 4-A22	HIS-S
-	-	-	-	+	-	-
TE-C HVU2	#2181356	+	-	-	-	-
TE-Y HVU2	#2230162...5	-	+	-	-	-
TE-C 1/2"	#32220	+	-	-	-	+
TE-Y 3/4"	#32221	-	+	-	-	+
SI-SA 1/4"-1/2"	#2077174	-	-	+	+	+
SI-SA 7/16"	#2134075	-	-	+	-	+

## Setting instructions

\*For detailed information on installation see instruction for use given with the package of the product.



### Safety regulations.

Review the Material Safety Data Sheet (MSDS) before use for proper and safe handling! Wear well-fitting protective goggles and protective gloves when working with Hilti HVU2.

### Hole drilling

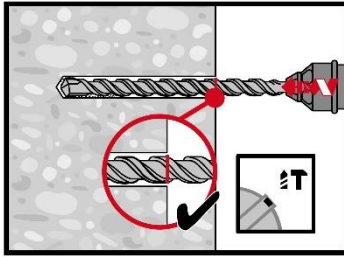

#### Hammer drilled hole

For dry or wet concrete and installation in flooded holes (no sea water).

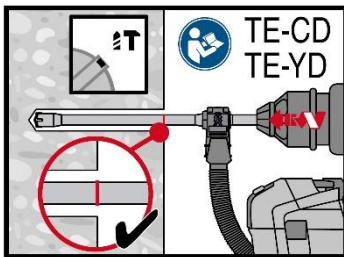

#### Hammer drilled hole with Hollow drill bit

For dry and wet concrete, only.  
No cleaning required.

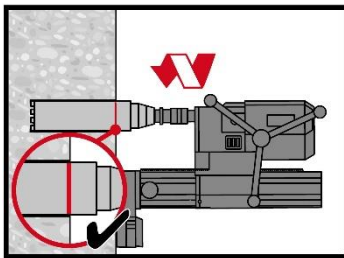

#### Diamond Coring

For dry or wet concrete only.

### Hole cleaning

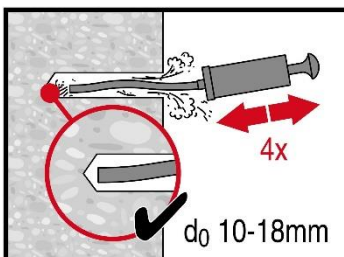

#### Manual cleaning for hammer drilled hole

for drill hole diameters  $d_0 \leq 18$  mm and drill hole depths  $h_0 \leq 10 \cdot d_0$ .

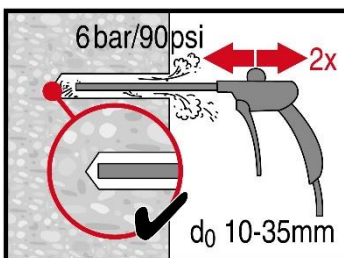

#### Compressed air cleaning (CAC) for hammer drilled hole

for all drill hole diameters  $d_0$  and all drill hole depths  $h_0$ .

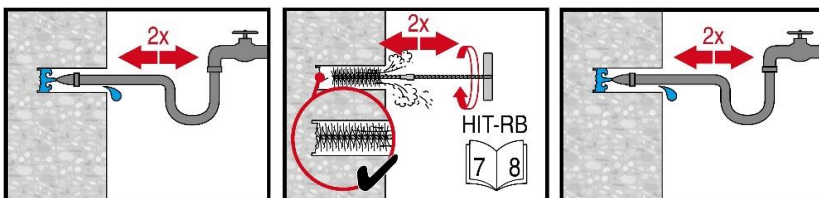

#### Hammer drilled flooded holes and diamond cored holes:

for all drill hole diameters  $d_0$  and all drill hole depths  $h_0$ .

Concrete  
Chemical anchors  
Mechanical anchors  
Plastic/Light duty metal anchors  
Insulation anchors

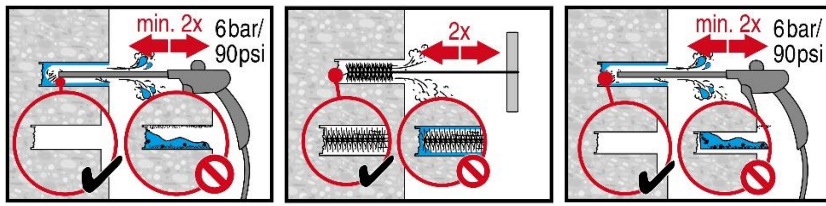

**Setting the element**

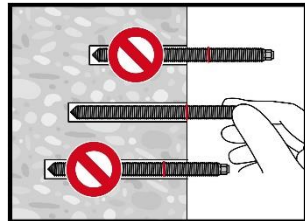
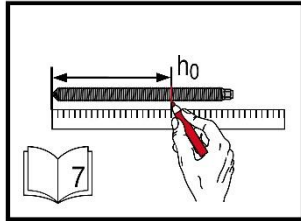

**Check setting depth.**

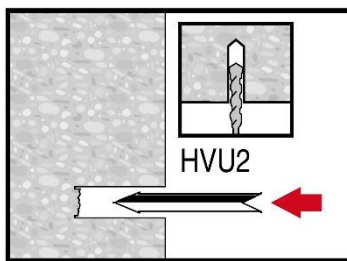

**Insert the foil capsule** with the peak ahead to the back of the hole.

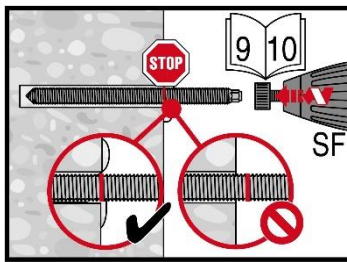

**Drive the anchor rod** with the plugged tool into the hole.

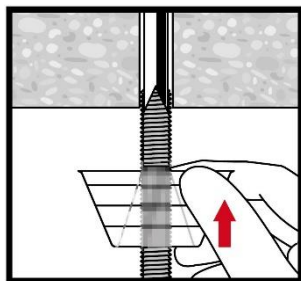
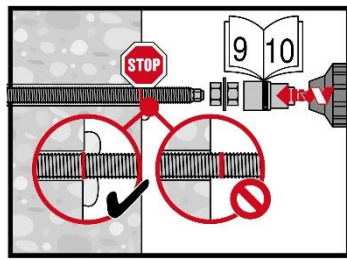

**Overhead installation**  
For HVU2 M8 to M24.

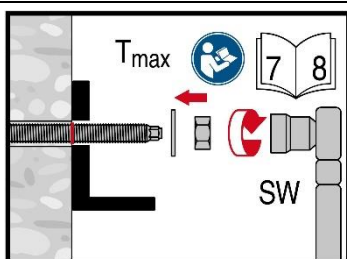

**Loading the anchor** after required curing time  $t_{cure}$ .



# HIT-HY 170 injection mortar

Anchor design (EN 1992-4) / Rods&Sleeves / Concrete

## Injection mortar system



Hilti HIT-HY 170

500 ml foil pack  
(also available as  
330 ml foil pack)

## Benefits

- Suitable for non-cracked and cracked <sup>a)</sup> concrete C 20/25 to C 50/60.
- Suitable for dry and water saturated concrete.
- Small edge distance and anchor spacing possible.
- High corrosion / corrosion resistant.
- In service temperature range up to 80°C short term / 50°C long term.



Anchor rod:  
HAS-U  
HAS-U HDG  
HAS-U A4  
HAS-U HCR  
(M8-M24)



Internally threaded sleeve:  
HIS-N  
HIS-RN  
(M8-M16)

a) Applications only with HAS-U anchor rods.

## Base material



Concrete (non-cracked)



Concrete (cracked) <sup>a)</sup>



Dry concrete



Wet concrete

## Load conditions



Static/  
quasi-static



Seismic,  
ETA-C2

## Installation conditions

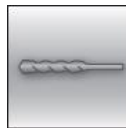

Hammer drilled holes

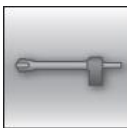

Hollow drill-bit drilling



Small edge embedment depth

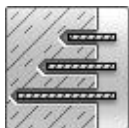

Variable embedment depth

## Other information



European Technical Assessment



CE conformity

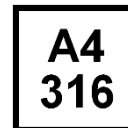

Corrosion resistance



High corrosion resistance <sup>a)</sup>

a) Applications only with HAS-U anchor rods.

## Approvals / certificates

Description	Authority / Laboratory	No. / date of issue
European technical Approval <sup>a)</sup>	DIBt, Berlin, Germany	ETA-19/0465 / 2019-08-28
European technical Approval <sup>b)</sup>	DIBt, Berlin, Germany	ETA-14/0457 / 2017-12-14

a) All data given in this section according to ETA-19/0465, issue 2019-08-28.

b) All data given in this section according to ETA-14/0457, issue 2017-12-14.

Multimaterial  
Chemical anchors  
Mechanical anchors  
Plastic/Light duty metal anchors  
Insulation anchors



## Basic loading data (for a single anchor)

### All data in this section applies to:

- Correct setting (See setting instruction)
- No edge distance and spacing influence
- Steel failure
- Base material thickness as specified in the table
- One typical embedment depth, as specified in the table
- One anchor material, as specified in the tables
- Concrete C 20/25,  $f_{ck,cube} = 25 \text{ N/mm}^2$
- Temperature range I (min. base material temp.  $-40^\circ\text{C}$ , max. long/short term base material temp.:  $+24^\circ\text{C}/40^\circ\text{C}$ )

### Embedment depth <sup>a)</sup>

Anchor size			M8	M10	M12	M16	M20	M24
<b>HAS-U</b>								
Embedment depth	$h_{ef}$	[mm]	80	90	110	125	170	210
Base material thickness	$h$	[mm]	110	120	140	160	220	270
<b>HIS-N</b>								
Embedment depth	$h_{ef}$	[mm]	90	110	125	170	-	-
Base material thickness	$h$	[mm]	120	150	170	230	-	-

a) The allowed range of embedment depth is shown in the setting details.

### For hammer drilled holes, hammer drilled holes with Hilti hollow drill bit:

#### Characteristic resistance

Anchor size			M8	M10	M12	M16	M20	M24
<b>Non-cracked concrete</b>								
Tension $N_{Rk}$	HAS-U 5.8	[kN]	18,0	28,3	41,5	62,8	106,8	158,3
	HAS-U 8.8		20,1	28,3	41,5	62,8	106,8	158,3
	HAS-U A4		20,1	28,3	41,5	62,8	106,8	158,3
	HAS-U HCR		20,1	28,3	41,5	62,8	106,8	158,3
	HIS-N 8.8		25	46,0	67,0	121,9	-	-
Shear $V_{Rk}$	HAS-U 5.8	[kN]	9,0	15,0	21,0	39,0	61,0	88,0
	HAS-U 8.8		15,0	23,0	34,0	63,0	98,0	141
	HAS-U A4		13,0	20,0	30,0	55,0	86,0	124
	HAS-U HCR		15,0	23,0	34,0	63,0	98,0	124
	HIS-N 8.8		13,0	23,0	34,0	63,0	-	-
<b>Cracked concrete</b>								
Tension $N_{Rk}$	HAS-U 5.8	[kN]	-	15,6	22,8	34,6	-	-
	HAS-U 8.8		-	15,6	22,8	34,6	-	-
	HAS-U A4		-	15,6	22,8	34,6	-	-
	HAS-U HCR		-	15,6	22,8	34,6	-	-
Shear $V_{Rk}$	HAS-U 5.8	[kN]	-	15,0	21,0	39,0	-	-
	HAS-U 8.8		-	23,0	34,0	63,0	-	-
	HAS-U A4		-	20,0	30,0	55,0	-	-
	HAS-U HCR		-	23,0	34,0	63,0	-	-



### Design resistance

Anchor size		M8	M10	M12	M16	M20	M24
<b>Non-cracked concrete</b>							
Tension $N_{Rd}$	HAS-U 5.8	12,0	18,8	27,6	41,9	71,2	99,8
	HAS-U 8.8	13,4	18,8	27,6	41,9	71,2	99,8
	HAS-U A4	13,4	18,8	27,6	41,9	71,2	99,8
	HAS-U HCR	13,4	18,8	27,6	41,9	71,2	99,8
	HIS-N 8.8	16,7	30,7	44,7	72,7	-	-
Shear $V_{Rd}$	HAS-U 5.8	7,2	12,0	16,8	31,2	48,8	70,4
	HAS-U 8.8	12,0	18,4	27,2	50,4	78,4	112,8
	HAS-U A4	8,3	12,8	19,2	35,3	55,1	79,5
	HAS-U HCR	12,0	18,4	27,2	50,4	78,4	70,9
	HIS-N 8.8	10,4	18,4	27,2	50,4	-	-
<b>Cracked concrete</b>							
Tension $N_{Rd}$	HAS-U 5.8	-	10,4	15,2	23,0	-	-
	HAS-U 8.8	-	10,4	15,2	23,0	-	-
	HAS-U A4	-	10,4	15,2	23,0	-	-
	HAS-U HCR	-	10,4	15,2	23,0	-	-
Shear $V_{Rd}$	HAS-U 5.8	-	12,0	16,8	31,2	-	-
	HAS-U 8.8	-	18,4	27,2	46,1	-	-
	HAS-U A4	-	12,8	19,2	35,3	-	-
	HAS-U HCR	-	18,4	27,2	46,1	-	-

### Recommended loads <sup>a)</sup>

Anchor size		M8	M10	M12	M16	M20	M24
<b>Non-cracked concrete</b>							
Tension $N_{Rec}$	HAS-U 5.8	8,6	13,5	19,7	29,9	50,9	71,3
	HAS-U 8.8	9,6	13,5	19,7	29,9	50,9	71,3
	HAS-U A4	9,6	13,5	19,7	29,9	50,9	71,3
	HAS-U HCR	9,6	13,5	19,7	29,9	50,9	71,3
	HIS-N 8.8	11,9	21,9	31,9	51,9	-	-
Shear $V_{Rec}$	HAS-U 5.8	5,1	8,6	12,0	22,3	34,9	50,3
	HAS-U 8.8	8,6	13,1	19,4	36,0	56,0	80,6
	HAS-U A4	6,0	9,2	13,7	25,2	39,4	56,8
	HAS-U HCR	8,6	13,1	19,4	36,0	56,0	50,6
	HIS-N 8.8	7,4	13,1	19,4	36,0	-	-
<b>Cracked concrete</b>							
Tension $N_{Rec}$	HAS-U 5.8	-	7,4	10,9	16,5	-	-
	HAS-U 8.8	-	7,4	10,9	16,5	-	-
	HAS-U A4	-	7,4	10,9	16,5	-	-
	HAS-U HCR	-	7,4	10,9	16,5	-	-
Shear $V_{Rec}$	HAS-U 5.8	-	8,6	12,0	22,3	-	-
	HAS-U 8.8	-	13,1	19,4	32,9	-	-
	HAS-U A4	-	9,2	13,7	25,2	-	-
	HAS-U HCR	-	13,1	19,4	32,9	-	-

a) With overall partial safety factor for action  $\gamma=1,4$ . The partial safety factors for action depend on the type of loading and shall be taken from national regulations.

## Seismic resistance

### All data in this section applies to:

- Hammer drilled holes and hammer drilled holes with hollow drill bit
- Correct setting (See setting instructions)
- No edge distance and spacing influence
- *Steel* failure
- Minimum base material thickness
- Concrete C20/25,  $f_{ck,cube} = 25 \text{ N/mm}^2$
- $\alpha_{gap} = 1,0$  (using Hilti seismic filling set)
- Temperature range I: -40 °C to +40 °C  
(max. long term temperature +24 °C and max. short term temperature +40 °C)

### Embedment depth and base material thickness for seismic C2

Anchor size		M8	M10	M12	M16	M20	M24
<b>HAS-U</b>							
Eff. Anchorage depth	[mm]	80	90	110	125	170	210
Base material thickness	[mm]	110	120	140	160	220	270

### For hammer drilled holes and hollow drill bit:

#### Characteristic resistance in case of seismic performance category C2

Anchor size		M8	M10	M12	M16	M20	M24
Tensile $N_{Rk}$	HAS-U 8.8, AM 8.8 [kN]	-	-	8,3	11,9	-	-
Shear $V_{Rk}$	HAS-U 8.8, AM 8.8 w/ filling set [kN]	-	-	28,0	46,0	-	-
	HAS-U 8.8, AM 8.8 w/o filling set [kN]	-	-	24,0	40,0	-	-

#### Design resistance in case of seismic performance category C2

Anchor size		M8	M10	M12	M16	M20	M24
Tensile $N_{Rd}$	HAS-U 8.8, AM 8.8 [kN]	-	-	5,5	8,0	-	-
Shear $V_{Rd}$	HAS-U 8.8, AM 8.8 w/ filling set [kN]	-	-	22,4	36,8	-	-
	HAS-U 8.8, AM 8.8 w/o filling set [kN]	-	-	19,2	32,0	-	-

## Materials

### Materials properties for HAS-U

Anchor size		M8	M10	M12	M16	M20	M24
Nominal tensile strength $f_{uk}$	HAS-U 5.8	500	500	500	500	500	500
	HAS-U 8.8	800	800	800	800	800	800
	HAS-U A4	700	700	700	700	700	700
	HAS-U HCR	800	800	800	800	800	700
Yield strength $f_{yk}$	HAS-U 5.8	400	400	400	400	400	400
	HAS-U 8.8	640	640	640	640	640	640
	HAS-U A4	450	450	450	450	450	450
	HAS-U HCR	640	640	640	640	640	400
Stressed cross-section $A_s$	HAS-U [mm <sup>2</sup> ]	36,6	58,0	84,3	157	245	353
Moment of resistance $W$	HAS-U [mm <sup>3</sup> ]	31,2	62,3	109	277	541	935

### Mechanical properties for HIS-N

Anchor size		M8	M10	M12	M16
Nominal tensile strength $f_{uk}$	HIS-N	490	490	490	490
	Screw 8.8	800	800	800	800
	HIS-RN	700	700	700	700
	Screw A4-70	700	700	700	700
Yield strength $f_{yk}$	HIS-N	390	390	390	390
	Screw 8.8	640	640	640	640
	HIS-RN	350	350	350	350
	Screw A4-70	450	450	450	450
Stressed cross-section $A_s$	HIS-(R)N [mm <sup>2</sup> ]	51,5	108,0	169,1	256,1
	Screw	36,6	58	84,3	157
Moment of resistance $W$	HIS-(R)N [mm <sup>3</sup> ]	145	430	840	1595
	Screw	31,2	62,3	109	277

### Material quality for HAS-U

Part	Material
<b>Zinc coated steel</b>	
Threaded rod, HAS-U 5.8 (HDG)	Strength class 5.8; Elongation at fracture A5 > 8% ductile Electroplated zinc coated $\geq 5\mu\text{m}$ ; (HDG) hot dip galvanized $\geq 45\mu\text{m}$
Threaded rod, HAS-U 8.8 (HDG)	Strength class 8.8; Elongation at fracture A5 > 12% ductile Electroplated zinc coated $\geq 5\mu\text{m}$ ; (HDG) hot dip galvanized $\geq 45\mu\text{m}$
Hilti Meter rod, AM 8.8 (HDG)	Strength class 8.8; Elongation at fracture A5 > 12% ductile Electroplated zinc coated $\geq 5\mu\text{m}$ (HDG) hot dip galvanized $\geq 45\mu\text{m}$
Washer	Electroplated zinc coated $\geq 5\mu\text{m}$ , hot dip galvanized $\geq 45\mu\text{m}$
Nut	Strength class of nut adapted to strength class of threaded rod. Electroplated zinc coated $\geq 5\mu\text{m}$ , hot dip galvanized $\geq 45\mu\text{m}$
Hilti Filling set (F)	Filling washer: Electroplated zinc coated $\geq 5\mu\text{m}$ , (F) hot dip galvanized $\geq 45\mu\text{m}$ Spherical washer: Electroplated zinc coated $\geq 5\mu\text{m}$ , (F) hot dip galvanized $\geq 45\mu\text{m}$ Lock nut: Electroplated zinc coated $\geq 5\mu\text{m}$ , (F) hot dip galvanized $\geq 45\mu\text{m}$
<b>Stainless Steel</b>	
Threaded rod, HAS-U A4	Strength class 70 for $\leq M24$ and strength class 50 for $> M24$ ; Elongation at fracture A5 > 8% ductile Stainless steel 1.4401; 1.4404; 1.4578; 1.4571; 1.4439; 1.4362
Washer	Stainless steel 1.4401, 1.4404, 1.4578, 1.4571, 1.4439, 1.4362 EN 10088-1:2014
Nut	Stainless steel 1.4401, 1.4404, 1.4578, 1.4571, 1.4439, 1.4362 EN 10088-1:2014
<b>High corrosion resistant steel</b>	
Threaded rod, HAS-U HCR	Strength class 80 for $\leq M20$ and class 70 for $> M20$ , Elongation at fracture A5 > 8% ductile High corrosion resistance steel 1.4529; 1.4565;
Washer	High corrosion resistant steel 1.4529, 1.4565 EN 10088-1:2014
Nut	High corrosion resistant steel 1.4529, 1.4565 EN 10088-1:2014

### Material quality for HIS-N

Part	Material	
HIS-N	Internal threaded sleeve	C-steel 1.0718 / Steel galvanized $\geq 5\mu\text{m}$
	Screw 8.8	Strength class 8.8, A5 > 8 % Ductile / Steel galvanized $\geq 5\mu\text{m}$
HIS-RN	Internal threaded sleeve	Stainless steel 1.4401, 1.4571
	Screw 70	Strength class 70, A5 > 8 % Ductile Stainless steel 1.4401; 1.4404, 1.4578; 1.4571; 1.4439; 1.4362

## Setting information

### Installation temperature range

-5°C to +40°C

### In service temperature range

Hilti HIT-HY 170 injection mortar with anchor rod HIT-V may be applied in the temperature ranges given below. An elevated base material temperature leads to a reduction of the design bond resistance.

### Temperature in the base material

Temperature range	Base material temperature	Maximum long term base material temperature	Maximum short term base material temperature
Temperature range I	-40 °C to +40 °C	+24 °C	+40 °C
Temperature range II	-40 °C to +80 °C	+50 °C	+80 °C

### Max short term base material temperature

Short-term elevated base material temperatures are those that occur over brief intervals, e.g. as a result of diurnal cycling.

### Max long term base material temperature

Long-term elevated base material temperatures are roughly constant over significant periods of time.

### Curing and working time <sup>a)</sup>

Temperature of the base material	Maximum working time $t_{work}$	Maximum curing time $t_{cure}$
$-5\text{ °C} \leq T_{BM} \leq 0\text{ °C}$ <sup>a)</sup>	10 min	12 hours
$0\text{ °C} \leq T_{BM} \leq 5\text{ °C}$ <sup>a)</sup>	10 min	5 hours
$5\text{ °C} \leq T_{BM} \leq 10\text{ °C}$	8 min	2,5 hours
$10\text{ °C} \leq T_{BM} \leq 20\text{ °C}$	5 min	1,5 hours
$20\text{ °C} \leq T_{BM} \leq 30\text{ °C}$	3 min	45 min
$30\text{ °C} \leq T_{BM} \leq 40\text{ °C}$	2 min	30 min

a) The curing time data are valid for dry base material only. In wet base material the curing times must be doubled.

### Setting details for HAS-U

Anchor size		M8	M10	M12	M16	M20	M24
Nominal diameter of drill bit	$d_0$ [mm]	10	12	14	18	22	28
Diameter of the element	$d$ [mm]	8	10	12	16	20	24
Eff. embedment depth and drill hole depth <sup>a)</sup>	$h_{ef,min}$ [mm]	60	60	70	80	90	96
	$h_{ef,ma}$ [mm]	96	120	144	192	240	288
Min. base material thickness	$h_{min}$ [mm]	$h_{ef} + 30 \text{ mm} \geq 100 \text{ mm}$			$h_{ef} + 2 d_0$		
Max. diameter of clearance hole in the fixture	$d_f$ [mm]	9	12	14	18	22	26
Max. torque moment <sup>b)</sup>	$T_{max}$ [Nm]	10	20	40	80	150	200
Min. spacing	$s_{min}$ [mm]	40	50	60	75	90	115
Min. edge distance	$c_{min}$ [mm]	40	45	45	50	55	60
Critical spacing for splitting failure	$s_{cr,sp}$ [mm]	$2 c_{cr,sp}$					
Critical edge distance for splitting failure <sup>c)</sup>	$c_{cr,sp}$ [mm]	$1,0 \cdot h_{ef}$ for $h / h_{ef} \geq 2,00$					
		$4,6 h_{ef} - 1,8 h$ for $2,00 > h / h_{ef} > 1,3$					
		$2,26 h_{ef}$ for $h / h_{ef} \leq 1,3$					
Critical spacing for concrete cone failure	$s_{cr,N}$ [mm]	$2 c_{cr,sp}$					
Critical edge distance for concrete cone failure <sup>d)</sup>	$c_{cr,N}$ [mm]	$1,5 h_{ef}$					

For spacing (edge distance) smaller than critical spacing (critical edge distance) the design loads have to be reduced.  $h_{ef,min} \leq h_{ef} \leq h_{ef,max}$  ( $h_{ef}$ : embedment depth)

- a) Maximum recommended torque moment to avoid splitting failure during instalation with minimum spacing and edge distance
- b)  $h$ : base material thickness ( $h \geq h_{min}$ )
- c) The critical edge distance for concrete cone failure depends on the embedment depth  $h_{ef}$  and the design bond resistance. The simplified formula given in this table is on the save side.

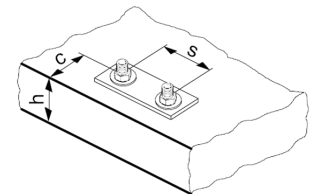

#### HAS-U...

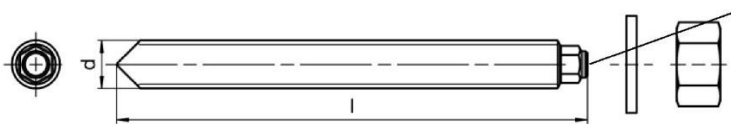

**Marking:**  
Steel grade number and length identification letter: e.g. 8L

#### AM 8.8

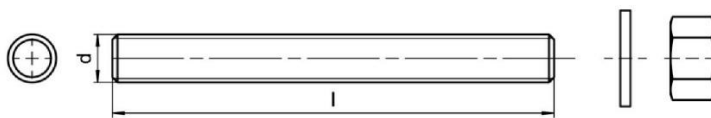

### Setting details for HIS-N

Anchor size		M8	M10	M12	M16
Nominal diameter of drill bit	$d_0$ [mm]	14	18	22	28
Diameter of element	$d$ [mm]	12,5	16,5	20,5	25,4
Eff. embedment depth and drill hole depth <sup>a)</sup>	$h_{ef}$ [mm]	90	110	125	170
	$h_{min}$ [mm]	120	150	170	230
Diameter of clearance hole in the fixture	$d_f$ [mm]	9	12	14	18
Thread engagement length min-max	$h_s$ [mm]	8-20	10-25	12-30	16-40
Min. spacing	$s_{min}$ [mm]	60	75	90	115
Min. edge distance	$c_{min}$ [mm]	40	45	55	65
Critical spacing for splitting failure	$s_{cr,sp}$ [mm]	$2 C_{cr,sp}$			
Critical edge distance for splitting failure <sup>a)</sup>	$c_{cr,sp}$ [mm]	$1,0 \cdot h_{ef}$ for $h / h_{ef} \geq 2,0$			
		$4,6 h_{ef} - 1,8 h$ for $2,0 > h / h_{ef} > 1,3$			
		$2,26 h_{ef}$ for $h / h_{ef} \leq 1,3$			
Critical spacing for concrete cone failure	$s_{cr,N}$ [mm]	$2 C_{cr,N}$			
Critical edge distance for concrete cone failure <sup>b)</sup>	$c_{cr,N}$ [mm]	$1,5 h_{ef}$			
Torque moment <sup>c)</sup>	$T_{max}$ [Nm]	10	20	40	80

For spacing (edge distance) smaller than critical spacing (critical edge distance) the design loads have to be reduced.

- a)  $h$ : base material thickness ( $h \geq h_{min}$ ),  $h_{ef}$ : embedment depth
- b) The critical edge distance for concrete cone failure depends on the embedment depth  $h_{ef}$  and the design bond resistance. The simplified formula given in this table is on the safe side.
- c) Maximum recommended torque moment to avoid splitting failure during installation with minimum spacing and/or edge distance.

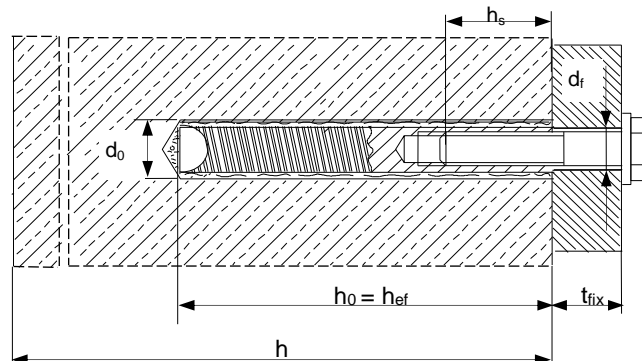



### Installation equipment

Anchor size		M8	M10	M12	M16	M20	M24
Rotary hammer	HIT-V	TE 2 (-A) – TE 30 (-A)				TE 40 - TE 80	
	HIS-N	TE 2 (-A) – TE 30 (-A)			TE 40 - TE 80		-
Other tools		compressed air gun and blow out pump, set of cleaning brushes, dispenser					

### Drilling and cleaning parameters

HAS-U	HIS-N	Drill bit diameters $d_0$ [mm]		Installation size [mm]	
		Hammer drill (HD)	Hollow Drill Bit (HDD)	Brush HIT-RB	Piston plug HIT-SZ
M8	-	10	-	10	-
M10	-	12	-	12	12
M12	M8	14	14	14	14
M16	M10	18	18	18	18
M20	M12	22	22	22	22
M24	M16	28	28	28	28

### Setting instructions

\*For detailed information on installation see instruction for use given with the package of the product



#### Safety regulations.

Review the Material Safety Data Sheet (MSDS) before use for proper and safe handling! Wear well-fitting protective goggles and protective gloves when working with Hilti HIT-HY 170.

### Drilling

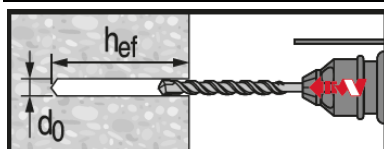

#### Hammer drilled hole

For dry and wet concrete.

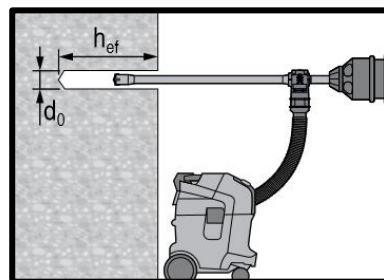

#### Hammer drilled hole with Hollow Drilled Bit (HDB)

No cleaning required.

### Cleaning

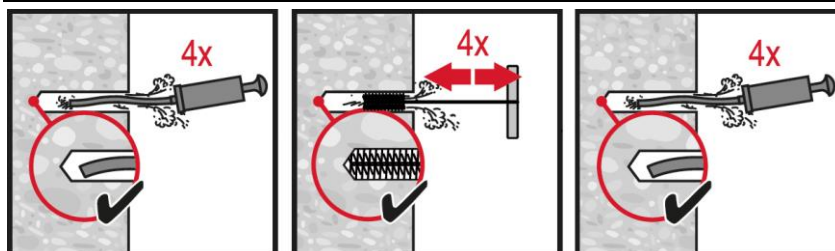

#### Manual cleaning (MC)

**Non-cracked concrete only**  
for drill diameters  $d_0 \leq 18$  mm and drill hole depth  $h_0 \leq 10 \cdot d_0$ .

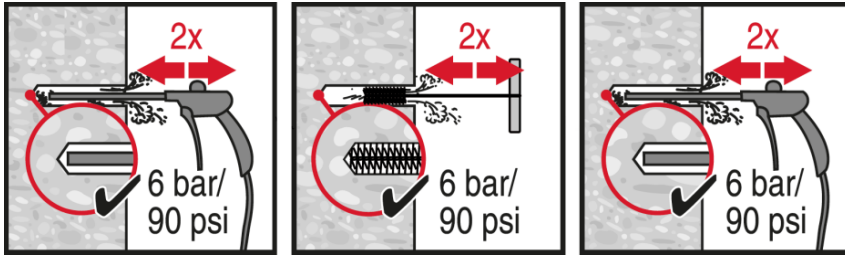

**Compressed air cleaning (CAC)**  
for all drill hole diameters  $d_0$  and drill hole depths  $h_0$ .

## Injection

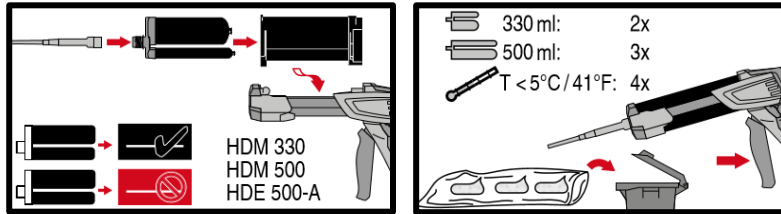

**Injection system preparation.**

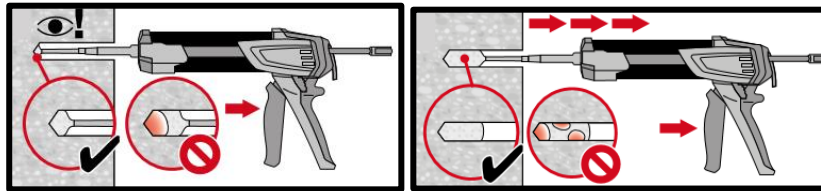

**Injection method for drill hole**

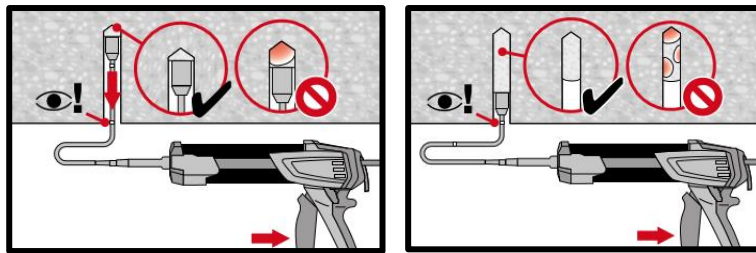

**Injection method for overhead application and/or installation with embedment depth  $h_{ef} > 250$  mm.**

## Setting the element

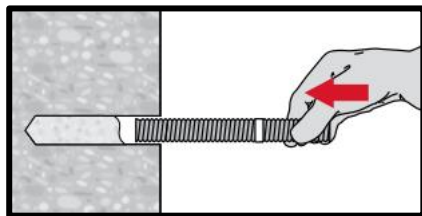

**Setting element**, observe working time " $t_{work}$ ".

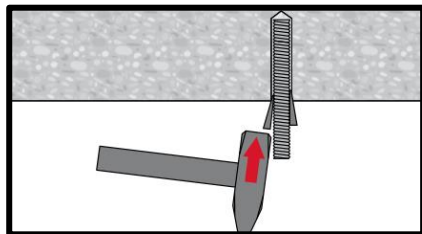

**Setting element for overhead applications**

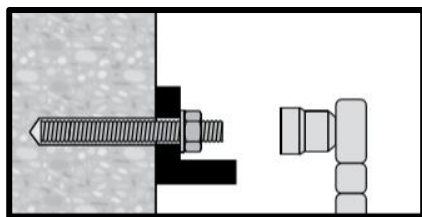

**Loading the anchor** after required curing time  $t_{cure}$



Chemical anchors    Multimaterial

Mechanical anchors

Plastic/Light duty metal anchors

Insulation anchors

# HIT-HY 170 injection mortar

Anchor design (ETAG 029) / Rods&Sleeves / Masonry

## Injection mortar system



Hilti HIT-HY 170

500 ml foil pack  
(also available as  
330 ml foil pack)



Anchor rod:  
HIT-V  
HIT-V-F  
HIT-V-R  
HIT-V-HCR  
(M8-M12)



Internally  
threaded sleeve:  
HIT-IC  
(M8-M12)

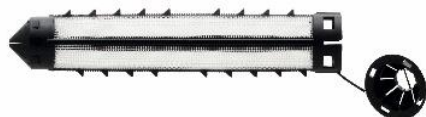

HIT-SC  
sieve sleeve  
(16-22)

## Benefits

- Chemical injection fastening for the most common types of base materials:
- Hollow and solid clay bricks, calcium silicate bricks, normal and light weight concrete blocks
- Two-component hybrid mortar
- Versatile and convenient handling with HDE dispenser
- Mortar filling control with HIT-SC sleeves

## Base material

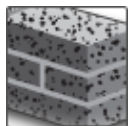

Solid brick

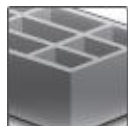

Hollow brick

## Load conditions

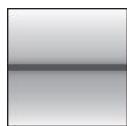

Static/  
quasi-static

## Installation conditions

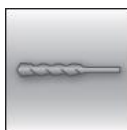

Hammer  
drilled holes

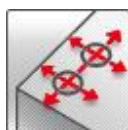

Small edge  
embedment  
depth



Variable  
embedment  
depth

## Other information



European  
Technical  
Assessment



CE  
conformity

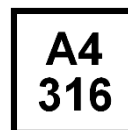

Corrosion  
resistance



High  
corrosion  
resistance



PROFIS  
Anchor  
design  
software

## Approvals / certificates

Description	Authority / Laboratory	No. / date of issue
European technical Approval <sup>a)</sup>	DIBt, Berlin, Germany	ETA-15/0197 / 2015-12-09

c) All data given in this section according to ETA-15/0197, issue 2015-12-09.

## Brick types and properties

### Instruction to this technical data

- Identify/choose your brick (or brick type) and its geometrical/physical properties on the following tables. Information about edge and spacing criteria for every brick is available on page 4.
- The pages referred on the last column of the table below contain the design resistance loads for pull-out failure of the anchor, brick breakout failure and local brick failure for each respective brick. Notice that the data displayed on these tables is only valid for single anchors with distance to edge equal to or greater than  $c_{cr}$  – for other cases not covered, use PROFIS Anchor software, consult ETA-15/0197 or contact Hilti Engineering Team.
- The resistance loads provided by this technical data manual are valid only for exact same masonry unit (hollow bricks) or for units made of the same base material with equal or higher size and compressive strength (solid bricks). For other cases, on-site tests must be performed-please consult page 8.

### Exterior brick dimensions

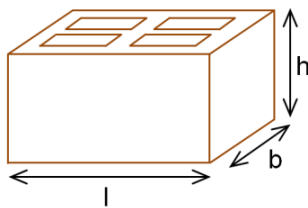

Generic bricks

### Interior dimensions of the majority of the holes

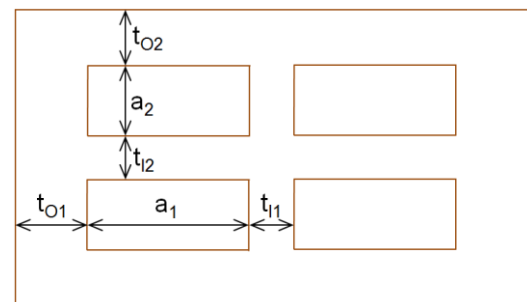

### Brick types and properties

Brick code	Data	Brick name	Image	Size [mm]	$t_0$ [mm]	$t_1$ [mm]	$a$ [mm]	$f_b$ [N/mm <sup>2</sup> ]	$\rho$ [kg/dm <sup>3</sup> ]	Page
<b>Solid Clay</b>										
SC	ETA	Solid clay brick Mz, 2DF		l: $\geq 240$ b: $\geq 115$ h: $\geq 113$	-	-	-	12	2,0	17
<b>Hollow Clay</b>										
HC	ETA	Hollow clay brick Hz, 10DF		l: 300 b: 240 h: 238	$t_{01}:12$ $t_{02}:15$	$t_{11}:11$ $t_{12}:15$	$a_1: 10$ $a_2: 25$	12/20	1,4	17
<b>Solid Calcium Silicate</b>										
SCS	ETA	Solid silica brick KS, 2DF		l: $\geq 240$ b: $\geq 115$ h: $\geq 113$	-	-	-	12/28	2,0	17
<b>Hollow Calcium Silicate</b>										
HCS	ETA	Hollow silica brick KSL, 8DF		l: 248 b: 240 h: 238	$t_{01}:34$ $t_{02}:21$	$t_{11}:12$ $t_{12}:30$	$a_1: 50$ $a_2: 50$	12/20	1,4	17
<b>Hollow lightweight concrete</b>										
HLWC	ETA	Hollow lightweight concrete brick		l: 495 b: 240 h: 238	$t_{01}:45$ $t_{02}:51$	$t_{11}:35$ $t_{12}:36$	$a_1:196$ $a_2: 52$	2/6	0,8	18
<b>Hollow normal weight concrete</b>										
HNWC	ETA	Hollow normal weight concrete brick		l: 500 b: 200 h: 200	$t_{01}:30$ $t_{02}:15$	$t_{11}:15$ $t_{12}:15$	$a_1:133$ $a_2: 75$	4/10	1,0	18

## Anchor installation parameters

### Brick position:

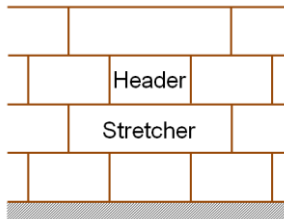

- **Header (H):** The longest dimension of the brick represents the width of the wall
- **Stretcher (S):** The longest dimension of the brick represents the length of the wall

### Spacing and edge distance:

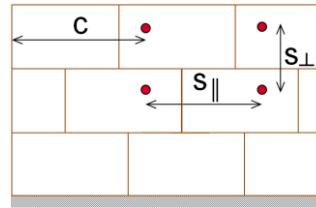

- c - Distance to the edge
- s<sub>||</sub> - Spacing parallel to the horizontal joint
- s<sub>⊥</sub> - Spacing perpendicular to the horizontal joint

### Minimum and characteristic spacing and edge distance parameters

- c<sub>min</sub> - Minimum edge distance
- c<sub>cr</sub> - Characteristic edge distance
- s<sub>min ||</sub> - Min. spacing distance parallel to the bed joint
- s<sub>cr ||</sub> - Characteristic spacing distance parallel to the bed joint
- s<sub>min ⊥</sub> - Min. spacing distance perpendicular to the bed joint
- s<sub>cr ⊥</sub> - Characteristic spacing distance perpendicular to the bed joint

### Allowed anchor positions:

$$c \geq c_{cr} = c_{min}$$

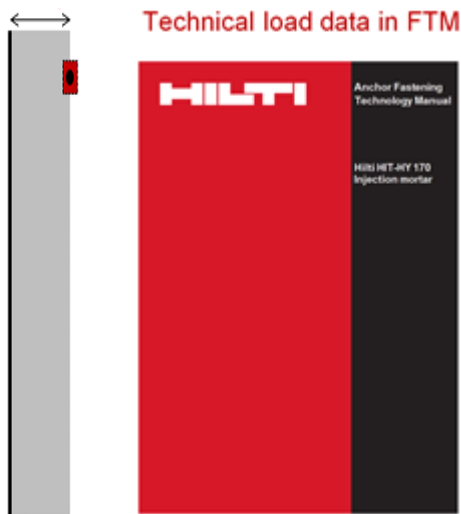

$$c \geq c_{cr} = c_{min}$$

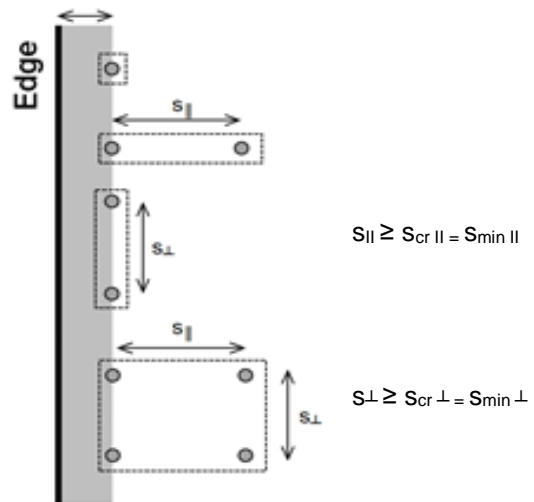

- This FTM includes the load data for single anchors in masonry with a distance to edge equal to or greater than the characteristic edge distance.

$$S_{||} \geq S_{cr ||} = S_{min ||}$$

$$S_{\perp} \geq S_{cr \perp} = S_{min \perp}$$

### Edge and spacing distances per brick

Brick code	$c_{min} = c_{cr}$ [mm]	$s_{min  } = s_{cr  }$ [mm]	$s_{min\perp} = s_{cr\perp}$ [mm]
SC	115	240	115
HC	150	300	240
SCS	115	240	115
HCS	125	248	240
HLC	250	240	240
HNC	200	200	200

### Anchor dimensions

Anchor size		M8	M10	M12
Embedment depth	HIT-V-(R, HCR) $h_{ef}$ [mm]	80		
Embedment depth	HIT-IT $h_{ef}$ [mm]	80		

### Design

- Anchorages are designed under the responsibility of an engineer experienced in anchorages and masonry work.
- Verifiable calculation notes and drawings are prepared taking account of the loads to be anchored. The position of the anchor is indicated on the design drawings (e.g. position of the anchor relative to supports, etc.).
- Anchorages under static or quasi-static loading are designed in accordance with: ETAG 029, Annex C, Design method A.

### Basic loading data (for a single anchor)

The load tables provide the design resistance load for a single loaded anchor.

All data in this section applies to:

- Edge distance  $c \geq c_{cr} = c_{min}$ .
- Correct anchor setting (see instruction for use, setting details)

Anchorages subject to:		Hilti HIT-HY 170 with HIT-V or HIT-IC	
Masonry		in solid bricks	in hollow bricks
Hole drilling 		hammer mode	rotary mode
Use category: dry or wet structure		Category <b>d/d</b> - <b>Installation and use</b> in structures subject to <b>dry</b> internal conditions. Category <b>w/d</b> - <b>Installation in dry or wet</b> substrate and <b>use</b> in structures subject to <b>dry</b> , internal conditions. Category <b>w/w</b> - <b>Installation and use</b> in structures subject to <b>dry or wet</b> environmental conditions.	
Installation direction		horizontal	
Use category		b (solid masonry)	c (hollow or perforated masonry)
Temperature in the base material at installation		+5° C to +40° C	-5° C to +40° C
In-service temperature	Temperature range Ta:	-40 °C to +40°C	(max. long term temperature +24°C and max. short term temperature +40 °C)
	Temperature range Tb:	-40 °C to +80°C	(max. long term temperature +50°C and max. short term temperature +80 °C)



### Tension loading

The design tensile resistance is the lower value of

- Steel resistance:  $N_{Rd,s}$
- Pull-out of the anchor:  $N_{Rd,p}$
- Brick breakout failure:  $N_{Rd,b}$
- Pull out of one brick  $N_{Rd,pb}$

### Shear loading

The design shear resistance is the lower value of

- Steel resistance:  $V_{Rd,s}$
- Local brick failure:  $V_{Rd,b}$
- Pushing out of one brick:  $V_{Rd,pb}$

#### Design tension and shear resistances – Steel failure for HIT-V

Anchor size		M8	M10	M12
Tension $N_{Rd,s}$	HIT-V 5.8(F)	12,2	19,3	28,1
	HIT-V 8.8(F)	19,5	30,9	44,9
	HIT-V-R	13,7	21,7	31,6
	HIT-V-HCR	19,5	30,9	44,9
Shear $V_{Rd,s}$	HIT-V 5.8(F)	7,4	11,6	16,9
	HIT-V 8.8(F)	11,7	18,6	27,0
	HIT-V-R	8,2	13,0	18,9
	HIT-V-HCR	11,7	18,6	27,0
$M^0_{Rd,s}$	HIT-V 5.8(F)	15,0	29,9	52,4
	HIT-V 8.8(F)	24,0	47,8	83,8
	HIT-V-R	16,9	33,6	59,0
	HIT-V-HCR	24,0	47,8	83,8

#### Design tension and shear resistances – Steel failure for internally threaded sleeves HIT-IC

Anchor size		M8	M10	M12
Tension $N_{Rd,s}$	HIT-IC [kN]	3,9	4,8	9,1
Shear $V_{Rd,s}$	HIT-IC [kN]	7,4	11,6	16,9
	Screw 8.8 [kN]	11,7	18,6	27,0
$M^0_{Rd,s}$	HIT-IC [Nm]	15,0	29,9	52,4
	Screw 8.8 [Nm]	24,0	47,8	83,8

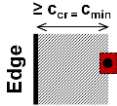

**Design tension and shear resistances – Pull-out failure of the anchor, brick breakout failure and local brick failure at characteristic edge distance ( $c \geq c_{cr} = c_{min}$ ) for single anchor applications**

Load type	Anchor size	$h_{ef}$ [mm]	$f_b$ [N/mm <sup>2</sup> ]	w/w and w/d		d/d		
				Ta	Tb	Ta	Tb	
Loads [kN]								
<b>SC - Solid clay brick</b> <b>Mz, 2DF</b>								
$N_{Rd,p} = N_{Rd,b}$ ( $c_{cr} = c_{min} = 115\text{mm}$ )	HIT-V	M8, M10, M12	80	12	1,2	1,0	1,2	1,0
	HIT-IC	M8			1,2	1,0	1,2	1,0
	HIT-IC	M10, M12			1,6	1,4	1,6	1,4
	HIT-V + HIT-SC	M8, M10, M12			1,6	1,4	1,6	1,4
	HIT-IC + HIT-SC	M8, M10, M12			1,6	1,4	1,6	1,4
$V_{Rd,b}$ ( $c_{cr} = c_{min} = 115\text{mm}$ )	HIT-V	M8, M10, M12	80	12	1,4			
HIT-V + HIT-SC	M8, M10, M12	1,4						
HIT-IC	M8, M10, M12	1,4						
HIT-IC + HIT-SC	M8, M10, M12	1,4						
<b>HC - Hollow clay brick</b> <b>Hlz, 10DF</b>								
$N_{Rd,p} = N_{Rd,b}$ ( $c_{cr} = c_{min} = 150\text{mm}$ )	HIT-V + HIT-SC	M8, M10, M12	80	12	1,2	1,0	1,2	1,0
	HIT-IC + HIT-SC	M8, M10, M12		20	1,4	1,2	1,4	1,2
$V_{Rd,b}$ ( $c_{cr} = c_{min} = 150\text{mm}$ )	HIT-V + HIT-SC	M8, M10, M12	80	12	0,8			
	HIT-IC + HIT-SC	M8, M10, M12		20	1,2			
<b>SCS - Solid silica brick</b> <b>KS, 2DF</b>								
$N_{Rd,p} = N_{Rd,b}$ ( $c_{cr} = c_{min} = 115\text{mm}$ )	HIT-V	M8, M10, M12	80	12	2,2	2,0	2,4	2,0
	HIT-IC	M8, M10, M12		28	3,4	3,0	3,4	3,0
	HIT-V + HIT-SC	M8, M10, M12		12	1,6	1,4	2,2	2,0
	HIT-IC + HIT-SC	M8, M10, M12		28	2,4	2,2	3,2	3,0
$V_{Rd,b}$ ( $c_{cr} = c_{min} = 115\text{mm}$ )	HIT-V	M8, M10, M12	80	12	1,6			
	HIT-V + HIT-SC	M8, M10, M12		28	2,4			
	HIT-IC	M8, M10, M12						
<b>HCS - Hollow silica brick</b> <b>KSL, 8DF</b>								
$N_{Rd,p} = N_{Rd,b}$ ( $c_{cr} = c_{min} = 125\text{mm}$ )	HIT-V + HIT-SC	M8, M10, M12	80	12	1,2	1,0	1,4	1,2
	HIT-IC + HIT-SC	M8, M10, M12		20	1,6	1,4	2,0	1,8
$V_{Rd,b}$ ( $c_{cr} = c_{min} = 125\text{mm}$ )	HIT-V + HIT-SC	M8, M10, M12	80	12	3,4			
	HIT-IC + HIT-SC	M8, M10, M12		20	4,8			

Chemical anchors Multimaterial

Mechanical anchors

Plastic/Light duty metal anchors

Insulation anchors

Load type	Anchor size	$h_{ef}$ [mm]	$f_b$ [N/mm <sup>2</sup> ]	w/w and w/d		d/d	
				Ta	Tb	Ta	Tb
Loads [kN]							
<b>HLWC – Hollow lightweight concrete brick</b> <b>HBL, 16DF</b>							
$N_{Rd,p} = N_{Rd,b}$ ( $C_{cr} = C_{min} = 250$ mm)	HIT-V + HIT-SC	M8, M10, M12	80	2	0,5	0,4	0,6
	HIT-IC + HIT-SC	M8, M10, M12		6	0,8	0,6	1,0
$V_{Rd,b}$ ( $C_{cr} = C_{min} = 250$ mm)	HIT-V + HIT-SC	M8, M10, M12	80	2	1,0		
	HIT-IC + HIT-SC	M8, M10, M12		6	1,6		
<b>HNWC – Hollow normal weight concrete brick</b> <b>Parpaing creux</b>							
$N_{Rd,p} = N_{Rd,b}$ ( $C_{cr} = C_{min} = 200$ mm)	HIT-V + HIT-SC	M8, M10, M12	80	4	0,4		
	HIT-IC + HIT-SC	M8, M10, M12		10	0,5	0,6	
$V_{Rd,b}$ ( $C_{cr} = C_{min} = 200$ mm)	HIT-V + HIT-SC	M8, M10, M12	80	4	1,0		
	HIT-IC + HIT-SC	M8, M10, M12		10	1,6		

### Design tension and shear resistances – Pull out and pushing out of one brick failures

#### Pull out of one brick (tension):

$$N_{Rd,pb} = 2 \cdot l \cdot b \cdot (0,5 \cdot f_{vko} + 0,4 \cdot \sigma_d) / (2,5 \cdot 1000) \text{ [kN]}$$

$$N_{Rd,pb}^* = (2 \cdot l \cdot b \cdot (0,5 \cdot f_{vko} + 0,4 \cdot \sigma_d) + b \cdot h \cdot f_{vko}) / (2,5 \cdot 1000) \text{ [kN]}$$

\* this equation is applicable if the vertical joints are filled

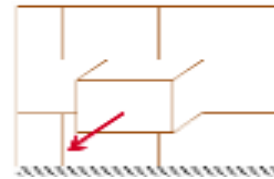

#### Pushing out of one brick (shear):

$$V_{Rd,pb} = 2 \cdot l \cdot b \cdot (0,5 \cdot f_{vko} + 0,4 \cdot \sigma_d) / (2,5 \cdot 1000) \text{ [kN]}$$

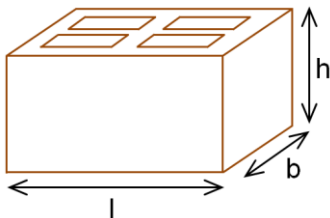
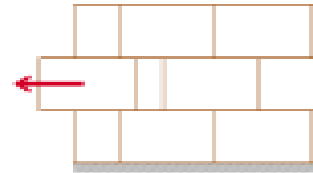

$\sigma_d$  = design compressive stress perpendicular to the shear (N/mm<sup>2</sup>)  
 $f_{vko}$  = initial shear strength according to EN 1996-1-1, Table 3.4

Brick type	Mortar strength	$f_{vko}$ [N/mm <sup>2</sup> ]
Clay brick	M2,5 to M9	0,20
	M10 to M20	0,30
All other types	M2,5 to M9	0,15
	M10 to M20	0,20

## On-site test



For other bricks in solid or hollow masonry, not covered by the Hilti HIT-HY 170 ETA or this technical data manual, the characteristic resistance may be determined by on-site tension tests (pull-out tests or proof-load tests), according to ETAG029, Annex B.

For the evaluation of test results, the characteristic resistance shall be obtained taking into account the  $\beta$  factor, which considers the different influences of the product.

The  $\beta$  factor for the brick types covered by the Hilti HIT-HY 170 ETA is provided in the following table:

Use categories		w/w and w/d		d/d	
Temperature range		Ta*	Tb*	Ta*	Tb*
Base material	Elements				
Solid clay brick	HIT-V or HIT-IC	0,97	0,83	0,97	0,83
	HIT-V + HIT-SC				
	HIT-IC + HIT-SC				
Solid calcium silicate brick	HIT-V or HIT-IC	0,96	0,84	0,97	0,84
	HIT-V + HIT-SC	0,69	0,62	0,91	0,82
	HIT-IC + HIT-SC				
Hollow clay brick	HIT-V + HIT-SC	0,97	0,83	0,97	0,83
	HIT-IC + HIT-SC				
Hollow calcium silicate brick	HIT-V + HIT-SC	0,69	0,62	0,91	0,82
	HIT-IC + HIT-SC				
Hollow lightweight concrete brick	HIT-V + HIT-SC	0,89	0,81	0,97	0,86
	HIT-IC + HIT-SC				
Hollow normal weight concrete brick	HIT-V + HIT-SC	0,97	0,80	0,97	0,80
	HIT-IC + HIT-SC				

\*Ta / Tb, w/w and d/d anchorage parameters, as defined on Tables pages 8-9

Applying the  $\beta$  factor from the table above, the characteristic tension resistance  $N_{Rk}$  can be obtained. Characteristic shear resistance  $V_{Rk}$  can also be directly derived from  $N_{Rk}$ . For detailed procedure consult ETAG 029, Annex B.

## Materials

### Material quality

Part	Material
Threaded rod HIT-V 5.8 (F)	Strength class 5.8, A5 > 8% ductile Steel galvanized $\geq 5\mu\text{m}$ ; (F) Hot dip galvanized $\geq 45\mu\text{m}$
Threaded rod HIT-V 8.8 (F)	Strength class 8.8, A5 > 8% ductile Steel galvanized $\geq 5\mu\text{m}$ ; (F) Hot dip galvanized $\geq 45\mu\text{m}$
Threaded rod HIT-V-R	Strength class 70 for $\leq M24$ and class 50 for $> M24$ , A5 > 8% ductile Stainless steel 1.4401; 1.4404; 1.4578; 1.4571; 1.4439; 1.4362
Threaded rod HIT-V-HCR	A5 > 8% ductile High corrosion resistant steel 1.4528, 1.4565
Internally threaded sleeve HIT-IC	A5 > 8% ductile Electroplated zinc coated $\geq 5\mu\text{m}$
Washer	Steel galvanized
	Stainless steel 1.4401; 1.4404; 1.4578; 1.4571; 1.4439; 1.4362
	High corrosion resistant steel 1.4529, 1.4565 EN 10088
Hexagon nut	Strength class 8 Electroplated zinc coated $\geq 5\mu\text{m}$ Hot dip galvanized $\geq 45\mu\text{m}$
	Strength class 70 Stainless steel grade A4 1.4401; 1.4404; 1.4578; 1.4571; 1.4439; 1.4362
	Strength class 70, high corrosion resistant steel, 1.4529; 1.4565
Internally threaded sleeve HIT-IC	A5 > 8% ductile Electroplated zinc coated $\geq 5\mu\text{m}$
Sieve sleeve HIT-SC	Frame: Polyfort FPP 20T Sieve: PA6.6 N500/200

### Base materials:

- Solid brick masonry. The characteristic resistances are also valid for larger brick sizes and larger compressive strengths of the masonry unit.
- Hollow brick masonry
- Mortar strength class of the masonry: M2,5 at minimum according to EN 998-2: 2010.
- For other bricks in solid masonry and in hollow or perforated masonry, the characteristic resistance of the anchor may be determined by on-site tests according to ETAG 029, Annex B under consideration of the  $\beta$ -factor according to Table page 9.

## Setting information

### Installation temperature range:

-5°C to +40°C

### In service temperature range

Hilti HIT-HY 170 injection mortar may be applied in the temperature ranges given below. An elevated base material temperature may lead to a reduction of the design bond resistance.

Temperature range	Base material temperature	Max. long term base material temperature	Max. short term base material temperature
Temperature range I	-40 °C to + 40 °C	+ 24 °C	+ 40 °C
Temperature range II	-40 °C to + 80 °C	+ 50 °C	+ 80 °C

**Max. short term base material temperature**

Short term elevated base material temperatures are those that occur over brief intervals, e.g. as a result of diurnal cycling.

**Max. long term base material temperature**

Long term elevated base material temperatures are roughly constant over significant periods of time.

**Working time and curing time**

Temperature of the base material	Maximum working time $t_{work}$	Minimum curing time $t_{cure}$
$-5\text{ °C} \leq T_{BM} \leq 0\text{ °C}$ <sup>a)</sup>	10 min	12 h
$0\text{ °C} \leq T_{BM} \leq 5\text{ °C}$ <sup>a)</sup>	10 min	5 h
$5\text{ °C} \leq T_{BM} \leq 10\text{ °C}$	8 min	2,5 h
$10\text{ °C} \leq T_{BM} \leq 20\text{ °C}$	5 min	1,5 h
$20\text{ °C} \leq T_{BM} \leq 30\text{ °C}$	3 min	45 min
$30\text{ °C} \leq T_{BM} \leq 40\text{ °C}$	2 min	30 min

The curing time data are valid for dry base material only. In wet base material the curing times must be doubled.

a) Data valid for hollow bricks only

**Installation Parameters**

**Single sieve sleeve,  $50\text{mm} > h_{ef} > 80\text{mm}$**

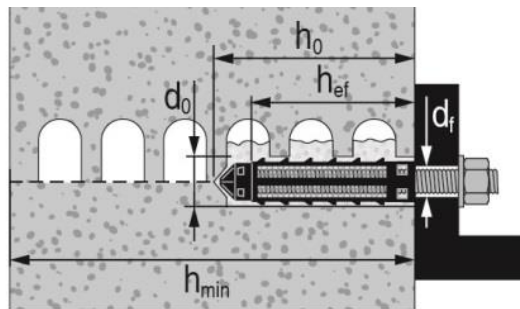

**Installation parameters of HIT-V with sieve sleeve HIT-SC in hollow and solid brick**

Threaded rods and HIT-V		M8	M10	M12
<b>with HIT-SC</b>		<b>16x85</b>		<b>18x85</b>
Nominal diameter of drill bit	$d_0$ [mm]	16	16	18
Drill hole depth	$h_0$ [mm]	95	95	95
Effective embedment depth	$h_{ef}$ [mm]	80	80	80
Maximum diameter of clearance hole in the fixture	$d_f$ [mm]	9	12	14
Minimum wall thickness	$h_{min}$ [mm]	115	115	115
Brush HIT-RB		16	16	18
Number of strokes HDM		6	6	8
Number of strokes HDE 500-		5	5	6
Maximum torque moment for all brick types except "parpaing creux"	$T_{max}$ [Nm]	3	4	6
Maximum torque moment for "parpaing creux"	$T_{max}$ [Nm]	2	2	3

### Installation parameters of HIT-IC with HIT-SC in hollow and solid brick

HIT-IC		M8	M10	M12
with HIT-SC		16x85	18x85	22x85
Nominal diameter of drill bit	$d_0$ [mm]	16	18	22
Drill hole depth	$h_0$ [mm]	95	95	95
Effective embedment depth	$h_{ef}$ [mm]	80	80	80
Thread engagement length	$h_s$ [mm]	8...75	10...75	12...75
Maximum diameter of clearance hole in the fixture	$d_f$ [mm]	9	12	14
Minimum wall thickness	$h_{min}$ [mm]	115	115	115
Brush HIT-RB		16	18	22
Number of strokes HDM		6	8	10
Number of strokes HDE-500		5	6	8
Maximum torque moment	$T_{max}$ [Nm]	3	4	6

#### Solid bricks without sieve sleeves <sup>a)</sup>

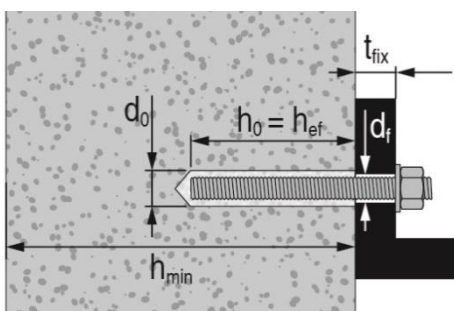

#### Installation parameters of HIT-V in solid bricks

Threaded rods and HIT-V		M8	M10	M12
Nominal diameter of drill bit	$d_0$ [mm]	10	12	14
Drill hole depth = Effective embedment depth	$h_0 = h_{ef}$ [mm]	50...300	50...300	50...300
Maximum diameter of clearance hole in the fixture	$d_f$ [mm]	9	12	14
Minimum wall thickness	$h_{min}$ [mm]	$h_0 + 30$	$h_0 + 30$	$h_0 + 30$
Brush HIT-RB		10	12	14
Maximum torque moment	$T_{max}$ [Nm]	5	8	10

a) Hilti recommends the anchoring in masonry always with sieve sleeve. Anchors can only be installed without sieve sleeves in solid bricks when it is guaranteed that it has not any hole or void.

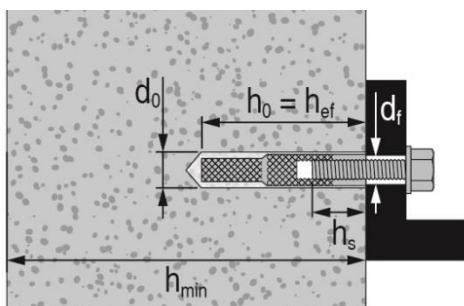



### Installation parameters of HIT-IC in solid bricks

HIT-IC		M8x80	M10x80	M12x80
Nominal diameter of drill bit	$d_0$ [mm]	14	16	18
Drill hole depth = Effective embedment depth	$h_0 = h_{ef}$ [mm]	80	80	80
Thread engagement length	$h_s$ [mm]	8...75	10...75	12...75
Maximum diameter of clearance hole in the fixture	$d_f$ [mm]	9	12	14
Minimum wall thickness	$h_{min}$ [mm]	115	115	115
Brush HIT-RB		14	16	18
Maximum torque moment	$T_{max}$ [Nm]	5	8	10

a) Hilti recommends the anchoring in masonry always with sieve sleeve. Anchors can only be installed without sieve sleeves in solid bricks when it is guaranteed that it has not any hole or void.

### Installation equipment

Anchor size	M8	M10	M12
Rotary hammer	TE2(A) – TE30(A)		
Other tools	compressed air gun or blow out pump, set of cleaning brushes, dispenser		

### Drilling and cleaning parameters

HIT-V <sup>a)</sup>	HIT-V + sieve sleeve	HIT-IC <sup>a)</sup>	HIT-IC + sieve sleeve	Hammer drill	Brush HIT-RB	Piston plug HIT-SZ
				$d_0$ [mm]	size [mm]	
<b>M8</b>	-	-	-	10	10	-
<b>M10</b>	-	-	-	12	12	12
<b>M12</b>	-	<b>M8</b>	-	14	14	14
-	<b>M8</b>	-	-	16	16	16
-	<b>M10</b>	<b>M10</b>	<b>M8</b>	16	16	16
-	<b>M12</b>	<b>M12</b>	<b>M10</b>	18	18	18
-	-	-	<b>M12</b>	22	22	22

a) Installation without the sieve sleeve HIT-SC can be used only in case of solid bricks.

## Setting instructions

\*For detailed information on installation see instruction for use given with the package of the product.



### Safety regulations.

Review the Material Safety Data Sheet (MSDS) before use for proper and safe handling! Wear well-fitting protective goggles and protective gloves when working with Hilti HIT-HY 170.

### Drilling

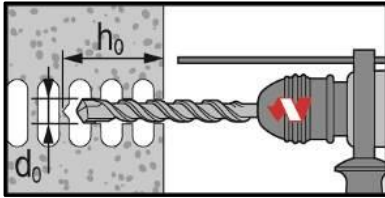

In hollow bricks: rotary mode

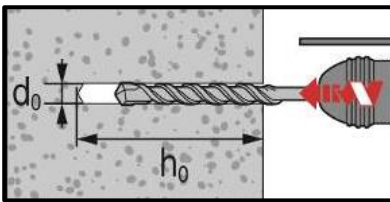

In solid bricks: hammer mode

### Cleaning

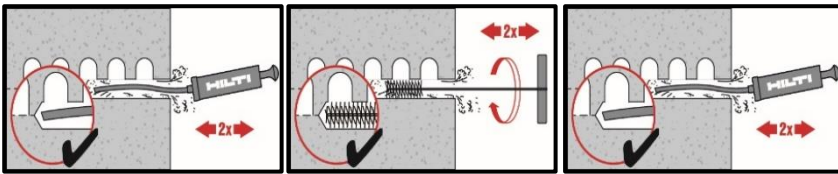

Manual cleaning (MC)

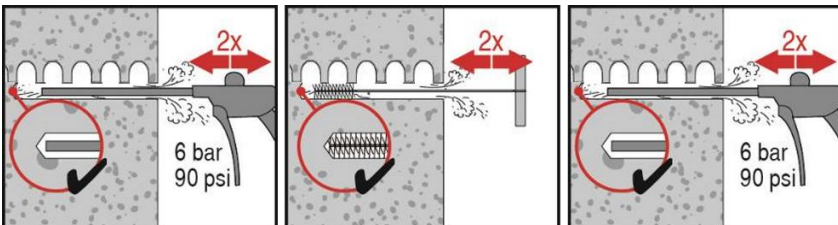

Compressed air cleaning (CAC)

### Instructions for solid bricks without sieve sleeve

#### Injection system

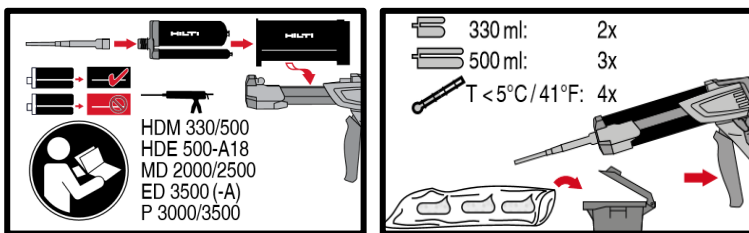

Injection system preparation.

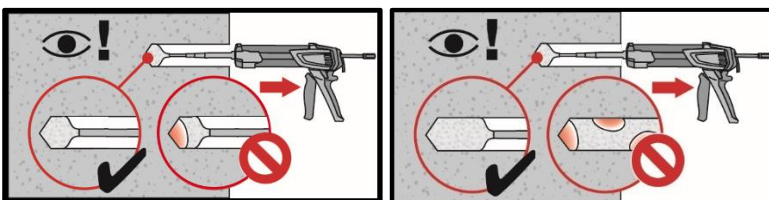

Injection method for drill hole

### Setting the element

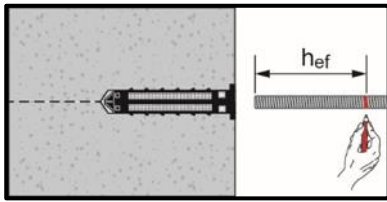

**Presetting element**, observe working time "t<sub>work</sub>",

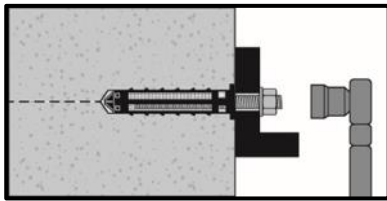

**Loading the anchor:** After required curing time t<sub>cure</sub> the anchor can be loaded.

### Instructions for hollow and solid bricks with sieve sleeve

#### Preparation of the sieve sleeve

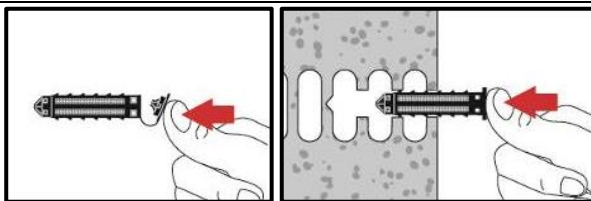

Close lid and insert sieve sleeve manually

#### Injection system

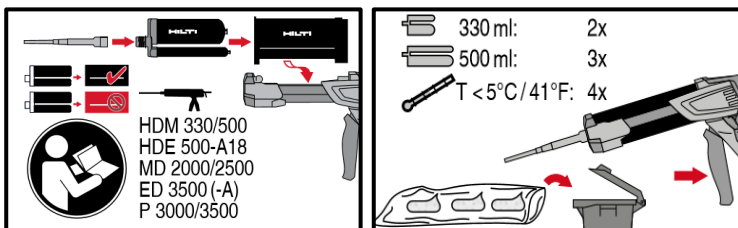

**Injection system preparation.**

#### Injection system: hollow bricks

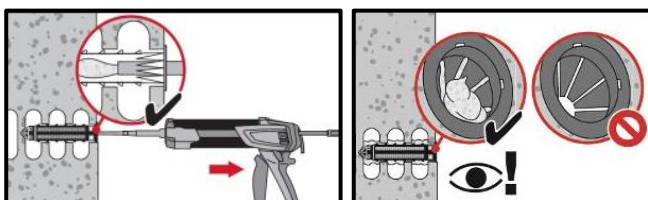

**Installation** with sieve sleeve HIT-SC

### Setting the element

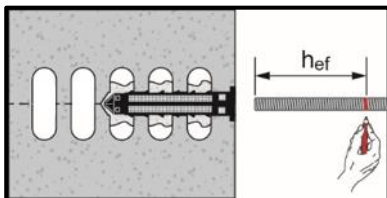

**Presetting element**, observe working time "t<sub>work</sub>",

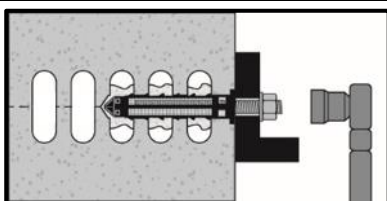



**Loading the anchor:** After required curing time t<sub>cure</sub> the anchor can be loaded.

# HIT-HY 170 injection mortar

Anchor design (EN 1992-4) / Rebar elements / Concrete

Injection mortar system	Benefits
 <p>Hilti HIT-HY 170 500 ml foil pack (also available as 330 ml foil pack)</p>	<ul style="list-style-type: none"> <li>- Suitable for non-cracked and cracked concrete C 12/15 to C 50/60</li> <li>- Suitable for dry and water saturated concrete</li> <li>- High loading capacity and fast cure</li> <li>- In service temperature range up to 80°C short term/50°C long term</li> <li>- Manual cleaning for drill hole sizes <math>\leq 18</math> mm and embedment depth <math>h_{ef} \leq 10d</math></li> </ul>
 <p>Rebar B500 B (<math>\phi 8</math>-<math>\phi 25</math>)</p>	

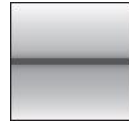
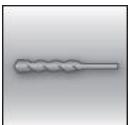
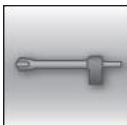
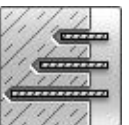
Base material	Load conditions
 <p>Concrete (non-cracked)</p>  <p>Dry concrete</p>  <p>Wet concrete</p>	 <p>Static/ quasi-static</p>
Installation conditions	Other information
 <p>Hammer drilling</p>  <p>Hollow drill-bit drilling</p>  <p>Variable embedment depth</p>	

**Approvals / certificates**

Description	Authority / Laboratory	No. / date of issue
Hilti Technical Data <sup>a)</sup>	Hilti	2017-11-28

a) All data given in this section according to Hilti Technical Data.

## Static and quasi-static loading (for a single anchor)

### All data in this section applies to

- Correct setting
- No edge distance and spacing influence
- ~~Steel~~ failure
- Base material thickness, as specified in the table
- One typical embedment depth, as specified in the table
- One anchor material, as specified in the tables
- Concrete C 20/25,  $f_{ck,cube} = 25 \text{ N/mm}^2$
- Temperate range I  
(min. base material temperature  $-40^\circ\text{C}$ , max. long term/short term base material temperature:  $+50^\circ\text{C}/80^\circ\text{C}$ )

### Embedment depth <sup>a)</sup> and base material thickness for static and quasi-static loading data

Anchor- size	$\phi 8$	$\phi 10$	$\phi 12$	$\phi 14$	$\phi 16$	$\phi 18$	$\phi 20$	$\phi 22$	$\phi 24$	$\phi 25$
Typical embedment depth [mm]	80	90	110	125	145	155	170	185	200	210
Base material thickness [mm]	110	120	140	161	185	199	220	237	256	274

a) The allowed range of embedment depth is shown in the setting details. The corresponding load values can be calculated according to the simplified design method.

### Characteristic resistance

Anchor- size	$\phi 8$	$\phi 10$	$\phi 12$	$\phi 14$	$\phi 16$	$\phi 18$	$\phi 20$	$\phi 22$	$\phi 24$	$\phi 25$
Tensile $N_{Rk}$	20,1	28,3	41,5	58,9	72,9	87,7	106,8	127,1	142,8	153,7
Shear $V_{Rk}$	14,0	22,0	31,0	42,0	55,0	70,0	86,0	104,0	124,0	135,0

### Design resistance

Anchor- size	$\phi 8$	$\phi 10$	$\phi 12$	$\phi 14$	$\phi 16$	$\phi 18$	$\phi 20$	$\phi 22$	$\phi 24$	$\phi 25$
Tensile $N_{Rd}$	13,4	18,8	27,6	39,3	48,6	58,4	71,2	84,7	95,2	102,5
Shear $V_{Rd}$	11,2	17,6	24,8	33,6	44,0	56,0	68,8	83,2	99,2	108,0

### Recommended loads <sup>a)</sup>

Anchor- size	$\phi 8$	$\phi 10$	$\phi 12$	$\phi 14$	$\phi 16$	$\phi 18$	$\phi 20$	$\phi 22$	$\phi 24$	$\phi 25$
Tensile $N_{Rec}$	9,6	13,5	19,7	28,0	34,7	41,7	50,9	60,5	68,0	73,2
Shear $V_{Rec}$	8,0	12,6	17,7	24,0	31,4	40,0	49,1	59,4	70,9	77,1

a) With overall partial safety factor for action  $\gamma = 1,4$ . The partial safety factors for action depend on the type of loading and shall be taken from national regulations.

## Materials

### Mechanical properties

Anchor size	$\phi 8$	$\phi 10$	$\phi 12$	$\phi 14$	$\phi 16$	$\phi 18$	$\phi 20$	$\phi 22$	$\phi 24$	$\phi 25$
Nominal tensile strength $f_{uk}$ [N/mm <sup>2</sup> ]	550	550	550	550	550	550	550	550	550	550
Yield strength $f_{yk}$ [N/mm <sup>2</sup> ]	500	500	500	500	500	500	500	500	500	500
Stressed cross-section $A_s$ [mm <sup>2</sup> ]	50,3	78,5	113,1	153,9	201,1	254,0	314,2	380	452	490,9
Moment of resistance $W$ [mm <sup>3</sup> ]	50,3	98,2	169,6	269,4	402,1	572,6	785,4	1045,3	1357,2	1534

### Material quality

Part	Material
Rebar EN 1992-1-1	Bars and de-coiled rods class B or C with $f_{yk}$ and $k$ according to NDP or NCL of EN 1992-1-1 $f_{uk} = f_{tk} = k \cdot f_{yk}$

### Setting information

#### Installation temperature

-5°C to +40°C

#### Service temperature range

Hilti HIT-HY 170 injection mortar may be applied in the temperature ranges given below. An elevated base material temperature may lead to a reduction of the design bond resistance.

Temperature range	Base material temperature	Max. long term base material temperature	Max. short term base material temperature
Temperature range I	- 40 °C to + 40 °C	+ 24 °C	+ 40 °C
Temperature range II	- 40 °C to + 80 °C	+ 50 °C	+ 80 °C

#### Max. short term base material temperature

Short term elevated base material temperatures are those that occur over brief intervals, e.g. as a result of diurnal cycling.

#### Max. long term base material temperature

Long term elevated base material temperatures are roughly constant over significant periods of time.

### Working time and curing time

Temperature of the base material	Max. working time in which rebar can be inserted and adjusted $t_{work}$	Min. curing time before rebar can be fully loaded $t_{cure}$
-5 °C ≤ $T_{BM}$ ≤ 0 °C <sup>a)</sup>	10 min	12 h
0 °C ≤ $T_{BM}$ ≤ 5 °C <sup>a)</sup>	10 min	5 h
5 °C ≤ $T_{BM}$ ≤ 10 °C	8 min	2,5 h
10 °C ≤ $T_{BM}$ ≤ 20 °C	5 min	1,5 h
20 °C ≤ $T_{BM}$ ≤ 30 °C	3 min	45 min
30 °C ≤ $T_{BM}$ ≤ 40 °C	2 min	30 min

The curing time data are valid for dry base material only. In wet base material the curing times must be doubled.

### Installation equipment

Rebar – size	Ø8	Ø10	Ø12	Ø14	Ø16	Ø18	Ø20	Ø22	Ø24	Ø25
Rotary hammer	TE2(-A) – TE30(-A)					TE40 – TE80				
Other tools	Blow out pump or Compressed air gun <sup>a)</sup> Set of cleaning brushes <sup>b)</sup> , dispenser, piston plug									

a) Compressed air gun with extension hose for all drill holes deeper than 250 mm (for  $\phi$  8 to  $\phi$  12) or deeper than  $20 \cdot \phi$  (for  $\phi > 12$  mm)

b) Automatic brushing with round brush for all drill holes deeper than 250 mm (for  $\phi$  8 to  $\phi$  12) or deeper than  $20 \cdot \phi$  (for  $\phi > 12$  mm)

### Setting details

Anchor size		Ø8	Ø10	Ø12		Ø14	Ø16	Ø18	Ø20	Ø22	Ø24	Ø25
Nominal diameter of drill bit	$d_0$ [mm]	10 / 12 <sup>a)</sup>	12 / 14 <sup>a)</sup>	14 <sup>a)</sup>	16 <sup>a)</sup>	18	20	22	25	26	28	32
Effective anchorage and drill hole depth range <sup>b)</sup>	$h_{ef,min}$ [mm]	60	60	70	70	75	80	85	90	95	100	100
	$h_{ef,max}$ [mm]	96	120	144	144	168	192	216	240	264	288	300
Minimum base material thickness	$h_{min}$ [mm]	$h_{ef} + 30 \text{ mm}$ $\geq 100 \text{ mm}$				$h_{ef} + 2 d_0$						
Minimum spacing	$s_{min}$ [mm]	40	50	60	60	70	80	90	100	110	120	125
Minimum edge distance	$c_{min}$ [mm]	40	50	60	60	70	80	90	100	110	120	125
Critical spacing for splitting failure	$s_{cr,sp}$ [mm]	$2 c_{cr,sp}$										
Critical edge distance for splitting failure <sup>c)</sup>	$c_{cr,sp}$ [mm]	$1,0 \cdot h_{ef}$ for $h / h_{ef} \geq 2,0$										
		$4,6 h_{ef} - 1,8 h$ for $2,0 > h / h_{ef} > 1,3$										
		$2,26 h_{ef}$ for $h / h_{ef} \leq 1,3$										
Critical spacing for concrete cone failure	$s_{cr,N}$ [mm]	$2 c_{cr,N}$										
Critical edge distance for concrete cone failure <sup>d)</sup>	$c_{cr,N}$ [mm]	$1,5 h_{ef}$										

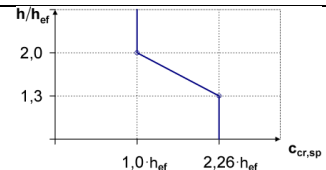

For spacing (edge distance) smaller than critical spacing (critical edge distance) the design loads have to be reduced.

- a) Both given values for drill bit diameter can be used
- b)  $h_{ef,min} \leq h_{ef} \leq h_{ef,max}$  ( $h_{ef}$ : embedment depth)
- c)  $h$ : base material thickness ( $h \geq h_{min}$ )
- d) The critical edge distance for concrete cone failure depends on the embedment depth  $h_{ef}$  and the design bond resistance. The simplified formula given in this table is on the safe side.

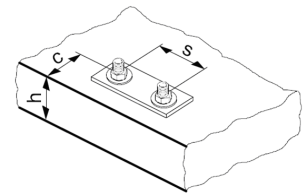

### Drilling and cleaning parameters

Rebar	Drill bit diameters $d_0$ [mm]		Installation size [mm]	
	Hammer drill (HD)	Hollow Drill Bit (HDB)	Brush HIT-RB	Piston plug HIT-SZ
Ø8	10 / 12 <sup>a)</sup>	-	10 / 12 <sup>a)</sup>	- / 12
Ø10	12 / 14 <sup>a)</sup>	14	12 / 14 <sup>a)</sup>	12 / 14 <sup>a)</sup>
Ø12	14 / 16 <sup>a)</sup>	16 (14 <sup>a)</sup> )	14 / 16 <sup>a)</sup>	14 / 16 <sup>a)</sup>
Ø14	18	18	18	18
Ø16	20	20	20	20
Ø18	22	22	22	22
Ø20	25	25	25	25
Ø22	28	28	28	28
Ø24	32	32	32	32
Ø25	32	32	32	32

a) Each of the two given values can be used



## Setting instructions

\*For detailed information on installation see instruction for use given with the package of the product.



### Safety regulations.

Review the Material Safety Data Sheet (MSDS) before use for proper and safe handling! Wear well-fitting protective goggles and protective gloves when working with Hilti HIT-HY 170.

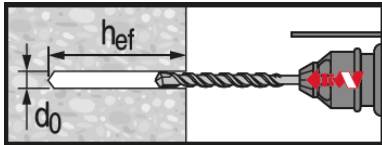

### Hammer drilled hole

For dry and wet concrete.

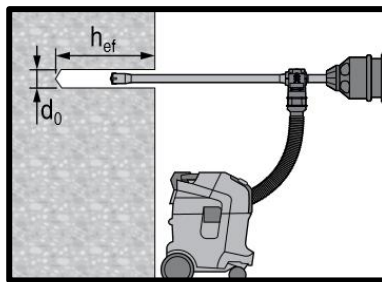

### Hammer drilled hole with Hollow Drilled Bit (HDB)

No cleaning required.

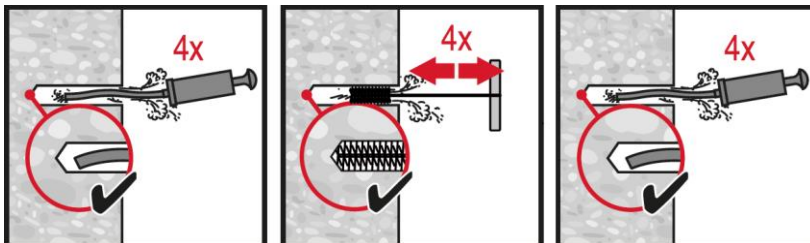

### Manual cleaning (MC)

for drill diameters  $d_0 \leq 20$  mm and drill hole depth  $h_0 \leq 10 \cdot d$ .



### Compressed air cleaning (CAC)

for all drill hole diameters  $d_0$  and drill hole depths  $h_0 \leq 20 \cdot d$ .

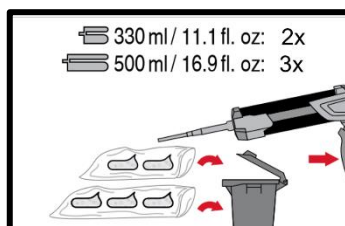
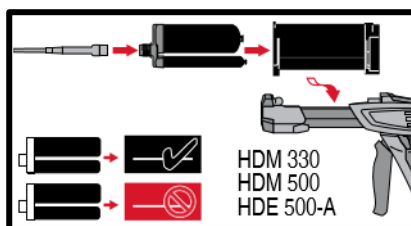

### Injection system preparation.

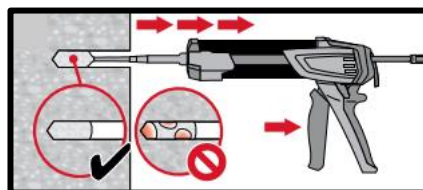
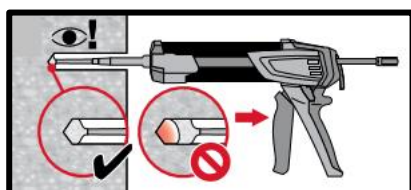

### Injection method for drill hole depth

$h_{ef} \leq 250$  mm.

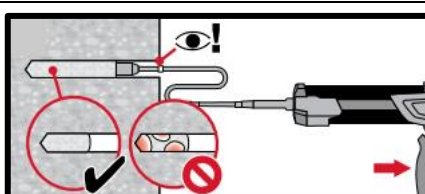
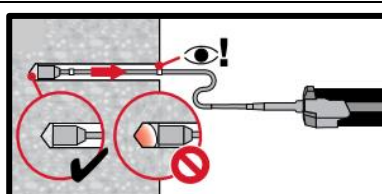

### Injection method for drill hole depth

$h_{ef} > 250$  mm.

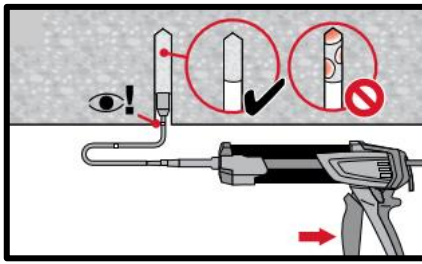
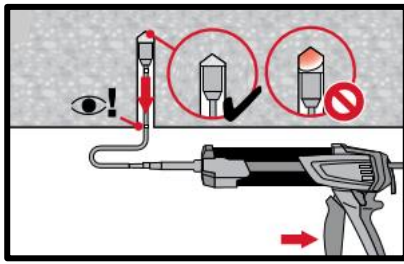

**Injection method** for overhead application.

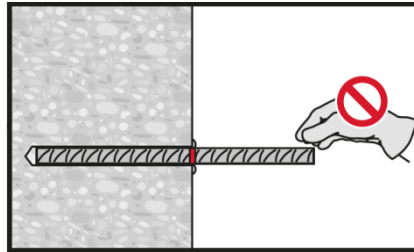
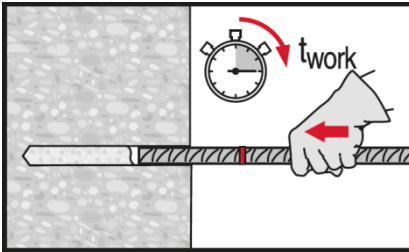

**Setting element**, observe working time " $t_{work}$ ".

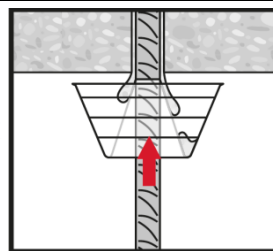
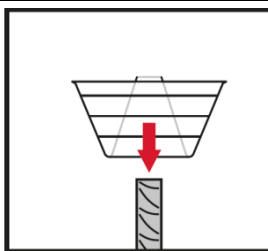
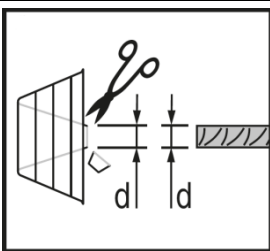

**Setting element** for overhead applications, observe working time " $t_{work}$ ".

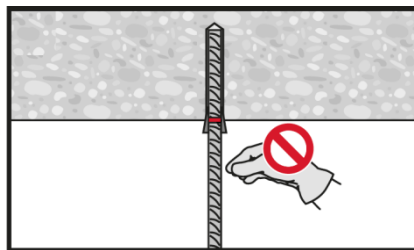
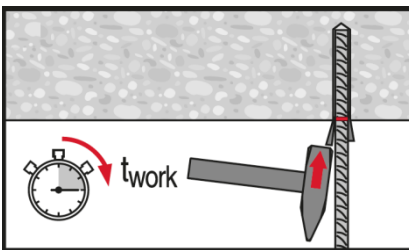

**Loading the anchor:** After required curing time  $t_{cure}$  the anchor can be loaded.

# HIT-HY 170 injection mortar

Rebar design (EOTA TR023) / Rebar elements / Concrete

## Injection mortar system



Hilti HIT-HY 170  
330 ml foil pack

(also available  
as 500 ml foil  
pack)



Rebar B500 B  
( $\phi 8 - \phi 25$ )

## Benefits

- Suitable for concrete C12/15 to C50/60
- Suitable for dry and water saturated concrete
- High loading capacity and fast cure
- High corrosion resistant
- For rebar diameters up to 25 mm
- Manual cleaning for drill hole sizes  $\leq 20$  mm and embedment depth  $h_{ef} \leq 10d$
- Suitable for embedment depth up to 1000 mm depending on the rebar diameter

## Base material



Concrete  
(Non-cracked)



Dry  
concrete



Water  
saturated  
concrete

## Load conditions

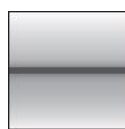

Static/quasi-  
static



Fire  
resistance

## Installation conditions

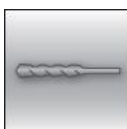

Hammer  
drilled holes

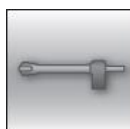

Hollow drill-  
bit drilling

## Other informations



European  
Technical  
Assessment



CE  
conformity

## Approvals / certificates

Description	Authority / Laboratory	No. / date of issue
European Technical Assessment <sup>a)</sup>	DIBt, Berlin	ETA-15/0297 / 2015-12-11

b) All data given in this section according to ETA-15/0297 issue 2015-12-11.

## Static and quasi-static loading

### Design bond strength

Design bond strength in N/mm<sup>2</sup> accord. to ETA-15/0297 for good bond conditions

#### All allowed drilling methods

Rebar - size	Concrete class								
	C12/15	C16/20	C20/25	C25/30	C30/37	C35/45	C40/50	C45/55	C50/60
φ8 - φ12	1,6	2,0	2,3	2,7	3,0	3,4	3,7	3,7	3,7
φ14 - φ25	1,6	2,0	2,3	2,7	3,0	3,4	3,4	3,4	3,4

For all other bond conditions multiply the values by 0,7.

### Minimum anchorage length and minimum lap length

The minimum anchorage length  $\ell_{b,min}$  and the minimum lap length  $\ell_{0,min}$  according to EN 1992-1-1 shall be multiplied by the relevant **Amplification factor**  $\alpha_{lb}$  in the table below.

**Amplification factor  $\alpha_{lb}$  for the min. anchorage length and min. lap length according to EN 1992-1-1 for:**

#### All allowed drilling methods

Rebar - size	Concrete class								
	C12/15	C16/20	C20/25	C25/30	C30/37	C35/45	C40/50	C45/55	C50/60
φ8 - φ25	1,0								

### Pre-calculated values

#### Pre-calculated values<sup>1)</sup> – anchorage length

Rebar yield strength  $f_{yk}=500$  N/mm<sup>2</sup>, concrete C25/30, good bond conditions

Rebar [mm]	Anchorage length $l_{bd}$ [mm]	Design value $N_{Rd}$ [kN]	Mortar volume <sup>2)</sup> $V_M$ [ml]	Anchorage length $l_{bd}$ [mm]	Design value $N_{Rd}$ [kN]	Mortar volume <sup>2)</sup> $V_M$ [ml]
	$\alpha_1=\alpha_2=\alpha_3=\alpha_4=\alpha_5=1,0$				$\alpha_1 = \alpha_3 = \alpha_4 = 1,0 \quad \alpha_2 \text{ or } \alpha_5 = 0,7$	
φ8	100	6,8	8	100	9,7	8
	170	11,5	13	140	13,6	11
	250	17,0	19	180	17,4	14
	<b>322</b>	<b>21,9</b>	24	<b>226</b>	<b>21,9</b>	17
φ10	121	10,3	11	121	14,7	11
	220	18,7	20	170	20,6	15
	310	26,3	28	230	27,9	21
	<b>403</b>	<b>34,2</b>	36	<b>281</b>	<b>34,1</b>	25
φ12	145	14,8	15	145	21,1	15
	260	26,5	27	210	30,5	22
	370	37,7	39	270	39,3	29
	<b>483</b>	<b>49,2</b>	51	<b>338</b>	<b>49,1</b>	36
φ14	169	20,1	20	169	28,7	20
	300	35,6	36	240	40,7	29
	430	51,1	52	320	54,3	39
	<b>564</b>	<b>67,0</b>	68	<b>394</b>	<b>66,8</b>	48
φ16	193	26,2	26	193	37,4	26
	340	46,1	46	280	54,3	38
	490	66,5	67	370	71,7	50
	<b>644</b>	<b>87,4</b>	87	<b>451</b>	<b>87,4</b>	61
φ18	217	33,1	33	217	47,3	33
	380	58,0	57	310	67,6	47
	540	82,4	81	410	89,4	62
	<b>700</b>	<b>106,9</b>	106	<b>507</b>	<b>110,6</b>	76
φ20	242	41,1	51	242	58,6	51
	390	66,2	83	350	84,8	74
	550	93,3	117	460	111,5	98
	<b>700</b>	<b>118,8</b>	148	<b>564</b>	<b>136,7</b>	120

### Pre-calculated values<sup>1)</sup> – anchorage length

Rebar yield strength  $f_{yk}=500 \text{ N/mm}^2$ , concrete C25/30, good bond conditions

Rebar [mm]	Anchorage length $l_{bd}$ [mm]	Design value $N_{Rd}$ [kN]	Mortar volume <sup>2)</sup> $V_M$ [ml]	Anchorage length $l_{bd}$ [mm]	Design value $N_{Rd}$ [kN]	Mortar volume <sup>2)</sup> $V_M$ [ml]
	$\alpha_1=\alpha_2=\alpha_3=\alpha_4=\alpha_5=1,0$					
φ22	266	49,6	75	266	70,9	75
	410	76,5	116	380	101,3	107
	560	104,5	158	500	133,3	141
	<b>700</b>	<b>130,6</b>	198	<b>620</b>	<b>165,3</b>	175
φ24	290	59,0	122	290	84,3	122
	430	87,5	182	420	122,1	177
	560	114,0	236	550	160,0	232
	<b>700</b>	<b>142,5</b>	296	<b>676</b>	<b>196,6</b>	285
φ25	302	64,0	114	302	91,5	114
	430	91,2	162	430	130,3	162
	570	120,9	214	570	172,7	214
	<b>700</b>	<b>148,4</b>	263	<b>700</b>	<b>212,1</b>	263

1) Values corresponding to the minimum anchorage length. The maximum permissible load is valid for "good bond conditions" as described in EN 1992-1-1. For all other conditions multiply by the value by 0,7.

2) The volume of mortar corresponds to the formula " $1,2 \cdot (d_0^2 - d_s^2) \cdot \pi \cdot l_b / 4$ " for hammer drilling

### Pre-calculated values<sup>1)</sup> – overlap length

Rebar yield strength  $f_{yk}=500 \text{ N/mm}^2$ , concrete C25/30, good bond conditions

Rebar [mm]	Overlap length $l_o$ [mm]	Design value $N_{Rd}$ [kN]	Mortar volume <sup>2)</sup> $V_M$ [ml]	Overlap length $l_o$ [mm]	Design value $N_{Rd}$ [kN]	Mortar volume <sup>2)</sup> $V_M$ [ml]
	$\alpha_1=\alpha_2=\alpha_3=\alpha_4=\alpha_5=1,0$					
φ8	200	13,6	15	200	19,4	15
	240	16,3	18	210	20,4	16
	280	19,0	21	220	21,3	17
	<b>322</b>	<b>21,9</b>	24	<b>226</b>	<b>21,9</b>	17
φ10	200	17,0	18	200	24,2	18
	270	22,9	24	230	27,9	21
	340	28,8	31	250	30,3	23
	<b>403</b>	<b>34,2</b>	36	<b>281</b>	<b>34,1</b>	25
φ12	200	20,4	21	200	29,1	21
	290	29,5	31	250	36,4	26
	390	39,7	41	290	42,2	31
	<b>483</b>	<b>49,2</b>	51	<b>338</b>	<b>49,1</b>	36
φ14	210	24,9	25	210	35,6	25
	330	39,2	40	270	45,8	33
	450	53,4	54	330	56,0	40
	<b>564</b>	<b>67,0</b>	68	<b>394</b>	<b>66,8</b>	48
φ16	240	32,6	33	240	46,5	33
	370	50,2	50	310	60,1	42
	510	69,2	69	380	73,7	52
	<b>644</b>	<b>87,4</b>	87	<b>451</b>	<b>87,4</b>	61
φ18	270	41,2	41	270	58,9	41
	410	62,6	62	350	76,3	53
	560	85,5	84	430	93,8	65
	<b>700</b>	<b>106,9</b>	106	<b>507</b>	<b>110,6</b>	76
φ20	300	50,9	64	300	72,7	64
	430	72,9	91	390	94,5	83
	570	96,7	121	480	116,3	102
	<b>700</b>	<b>118,8</b>	148	<b>564</b>	<b>136,7</b>	120
φ22	330	61,6	93	330	88,0	93
	450	84,0	127	430	114,6	122
	580	108,2	164	520	138,6	147
	<b>700</b>	<b>130,6</b>	198	<b>620</b>	<b>165,3</b>	175
φ24	360	73,3	152	360	104,7	152
	470	95,7	198	470	136,7	198
	590	120,1	249	570	165,8	241

### Pre-calculated values<sup>1)</sup> – overlap length

Rebar yield strength  $f_{yk}=500$  N/mm<sup>2</sup>, concrete C25/30, good bond conditions

Rebar [mm]	Overlap length $l_0$ [mm]	Design value $N_{Rd}$ [kN]	Mortar volume <sup>2)</sup> $V_M$ [ml]	Overlap length $l_0$ [mm]	Design value $N_{Rd}$ [kN]	Mortar volume <sup>2)</sup> $V_M$ [ml]
	$\alpha_1=\alpha_2=\alpha_3=\alpha_4=\alpha_5=1,0$				$\alpha_1 = \alpha_3 = \alpha_4 = 1,0 \quad \alpha_2 \text{ or } \alpha_5 = 0,7$	
$\phi 25$	700	142,5	296	676	196,6	285
	375	79,5	141	375	113,6	141
	480	101,8	181	480	145,4	181
	590	125,1	222	590	178,7	222
	700	148,4	263	700	212,1	263

- 1) Values corresponding to the minimum anchorage length. The maximum permissible load is valid for "good bond conditions" as described in EN 1992-1-1. For all other conditions multiply by the value by 0,7.
- 2) The volume of mortar corresponds to the formula " $1,2 \cdot (d_0^2 - d_s^2) \cdot \pi \cdot l_b / 4$ " for hammer drilling

## Materials

### Material quality

Part	Material
Rebar EN 1992-1-1	Bars and de-coiled rods class B or C with $f_{yk}$ and $k$ according to NDP or NCL of EN 1992-1-1 $f_{uk} = f_{tk} = k \cdot f_{yk}$

### Fitness for use

Some creep tests have been conducted in accordance with ETAG guideline 001 part 5 and TR 023 in the following conditions: **in dry environment at 50 °C during 90 days.**

These tests show an excellent behaviour of the post-installed connection made with HIT-HY 170: low displacements with long term stability, failure load after exposure above reference load.

### Resistance to chemical substance

Chemical substance	Comment	Resistance
Sulphuric acid	23°C	+
Alkaline medium	pH = 13,2, 23°C	+

### Installation temperature range

-5°C to +40°C

### Service temperature range

Hilti HIT-HY 170 injection mortar may be applied in the temperature ranges given below. An elevated base material temperature may lead to a reduction of the design bond resistance.

Temperature range	Base material temperature	Maximum long term base material temperature	Maximum short term base material temperature
Temperature range I	-40 °C to +80 °C	+50 °C	+80 °C

### Max short term base material temperature

Short-term elevated base material temperatures are those that occur over brief intervals, e.g. as a result of diurnal cycling.

### Max long term base material temperature

Long-term elevated base material temperatures are roughly constant over significant periods of time.



## Working time and curing time

Temperature of the base material $T_{BM}$	Maximum working time $t_{gel}$	Minimum curing time $t_{cure}^{1)}$
$-5\text{ °C} \leq T_{BM} \leq 0\text{ °C}^a)$	10 min	12 hours
$0\text{ °C} \leq T_{BM} \leq 5\text{ °C}^a)$	10 min	5 hours
$5\text{ °C} \leq T_{BM} \leq 10\text{ °C}$	8 min	2,5 hours
$10\text{ °C} \leq T_{BM} \leq 20\text{ °C}$	5 min	1,5 hours
$20\text{ °C} \leq T_{BM} \leq 30\text{ °C}$	3 min	45 min
$30\text{ °C} \leq T_{BM} \leq 40\text{ °C}$	2 min	30 min

1) The curing time data are valid for dry base material only. In wet base material the curing times must be doubled.

## Setting information

### Installation equipment

Rebar – size	$\phi 8$	$\phi 10$	$\phi 12$	$\phi 14$	$\phi 16$	$\phi 18$	$\phi 20$	$\phi 22$	$\phi 24$	$\phi 25$
Rotary hammer	TE2(-A) – TE30(-A)					TE40 – TE80				
Other tools	Blow out pump ( $h_{ef} \leq 10 \cdot d$ )					-				
	Compressed air gun <sup>a)</sup> Set of cleaning brushes <sup>b)</sup> , dispenser, piston plug									

c) Compressed air gun with extension hose for all drill holes deeper than 250 mm (for  $\phi 8$  to  $\phi 12$ ) or deeper than  $20 \cdot \phi$  (for  $\phi > 12$  mm)

d) Automatic brushing with round brush for all drill holes deeper than 250 mm (for  $\phi 8$  to  $\phi 12$ ) or deeper than  $20 \cdot \phi$  (for  $\phi > 12$  mm)

### Minimum concrete cover $c_{min}$ of the post-installed rebar

Drilling method	Bar diameter [mm]	Minimum concrete cover $c_{min}$ [mm]	
		Without drilling aid	With drilling aid
Hammer drilling (HD)	$\phi < 25$	$30 + 0,06 \cdot l_v \geq 2 \cdot \phi$	$30 + 0,02 \cdot l_v \geq 2 \cdot \phi$
	$\phi \geq 25$	$40 + 0,06 \cdot l_v \geq 2 \cdot \phi$	$40 + 0,02 \cdot l_v \geq 2 \cdot \phi$
Compressed air drilling (CA)	$\phi < 25$	$50 + 0,08 \cdot l_v$	$50 + 0,02 \cdot l_v$
	$\phi \geq 25$	$60 + 0,08 \cdot l_v \geq 2 \cdot \phi$	$60 + 0,02 \cdot l_v \geq 2 \cdot \phi$

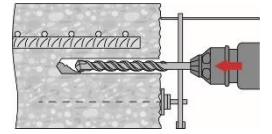

### Drilling and cleaning parameters

Rebar	Hammer drilling (HD)	Compressed air drilling (CA)	Brush HIT-RB	Air nozzle HIT-RB
	$d_0$ [mm]		size [mm]	
$\phi 8$	10 <sup>a)</sup>	-	10	10
	12	-	12	12
$\phi 10$	12 <sup>a)</sup>	-	12	12
	14	-	14	14
$\phi 12$	14 <sup>a)</sup>	-	14	14
	16	-	16	16
	-	17	18	16
$\phi 14$	18	-	18	18
	-	17	18	16
$\phi 16$	20	20	20	20
$\phi 18$	22	22	22	22
$\phi 20$	25	-	25	25
	-	26	28	25
$\phi 22$	28	28	28	28
$\phi 24$	32	32	32	32
$\phi 25$	32	32	32	32

a) Maximum installation length  $l=250$  mm.



### Drilling and cleaning parameters

Rebar	Drill bit diameters $d_0$ [mm]		Installation size [mm]	
	Hammer drill (HD)	Hollow Drill Bit (HDB)	Brush HIT-RB	Piston plug HIT-SZ
$\phi 8$	10 / 12 <sup>a)</sup>	-	10 / 12 <sup>a)</sup>	- / 12
$\phi 10$	12 / 14 <sup>a)</sup>	14	12 / 14 <sup>a)</sup>	12 / 14 <sup>a)</sup>
$\phi 12$	14 / 16 <sup>a)</sup>	16 (14 <sup>a)</sup> )	14 / 16 <sup>a)</sup>	14 / 16 <sup>a)</sup>
$\phi 14$	18	18	18	18
$\phi 16$	20	20	20	20
$\phi 18$	22	22	22	22
$\phi 20$	25	25	25	25
$\phi 22$	28	28	28	28
$\phi 24$	32	32	32	32
$\phi 25$	32	32	32	32

### Dispensers and corresponding maximum embedment depth $l_{v,max}$

Rebar	Dispenser HDM 330, HDM 500, HDE 500
	$l_{v,max}$ [mm]
$\phi 8$ to $\phi 16$	1000
$\phi 18$ to $\phi 25$	700

## Setting instructions

\*For detailed information on installation see instruction for use given with the package of the product.



### Safety regulations.

Review the Material Safety Data Sheet (MSDS) before use for proper and safe handling! Wear well-fitting protective goggles and protective gloves when working with Hilti HIT-HY 170.

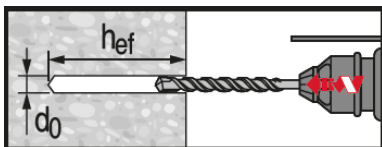

### Hammer drilled hole

For dry and wet concrete.

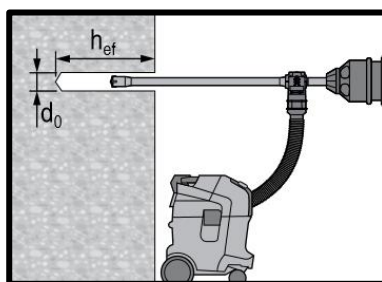

### Hammer drilled hole with Hollow Drilled Bit (HDB)

No cleaning required.

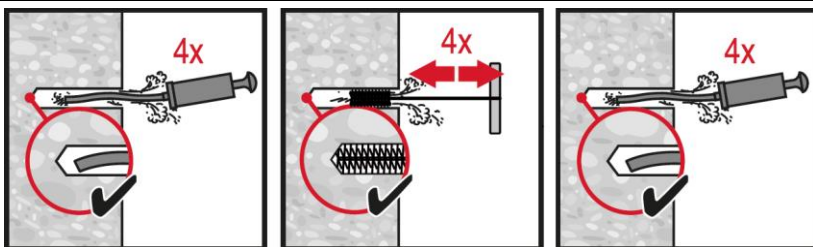

### Manual cleaning (MC)

for drill diameters  $d_0 \leq 20$  mm and drill hole depth  $h_0 \leq 10 \cdot d$ .

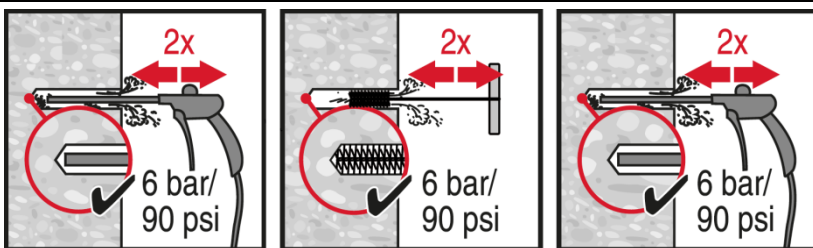

### Compressed air cleaning (CAC)

for all drill hole diameters  $d_0$  and drill hole depths  $h_0 \leq 20 \cdot d$ .

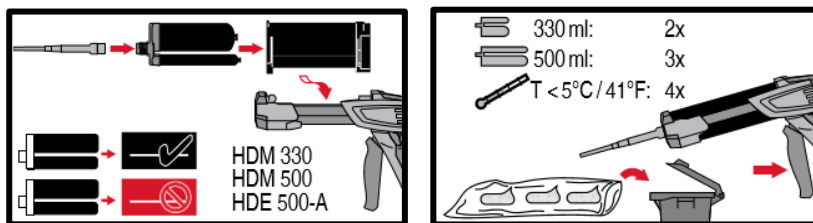

### Injection system preparation.

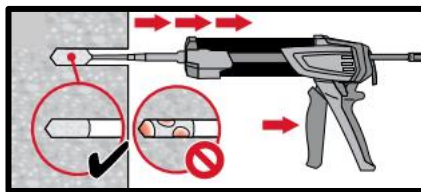
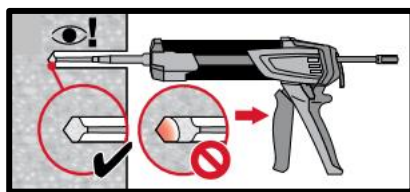

### Injection method for drill hole depth $h_{ef} \leq 250$ mm.

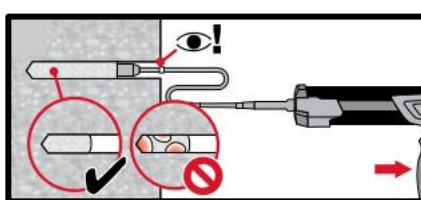
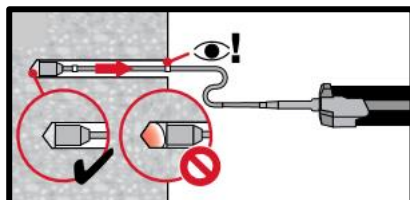

### Injection method for drill hole depth $h_{ef} > 250$ mm.

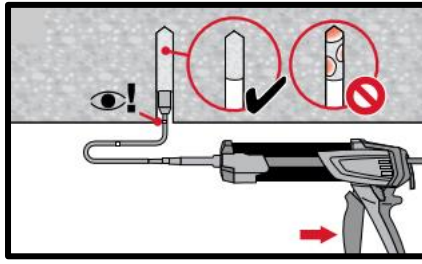
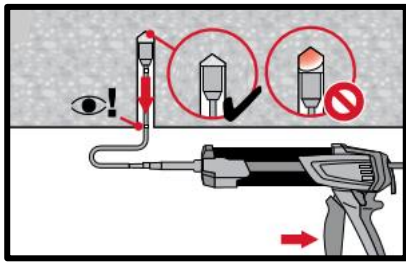

**Injection method for overhead application.**

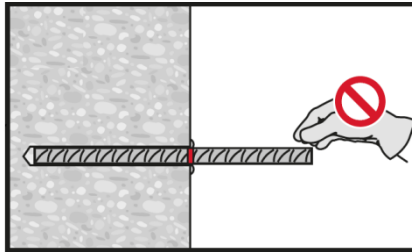
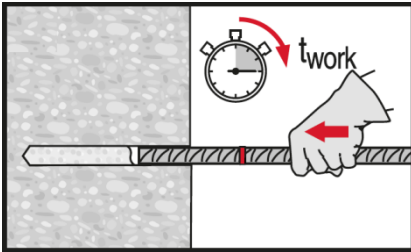

**Setting element, observe working time "t<sub>work</sub>".**

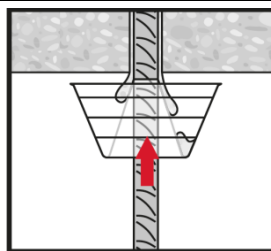
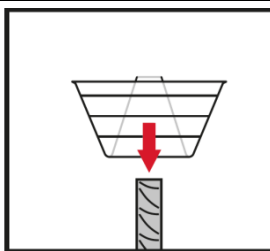
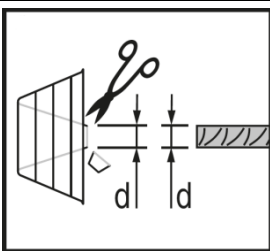

**Setting element for overhead applications, observe working time "t<sub>work</sub>".**

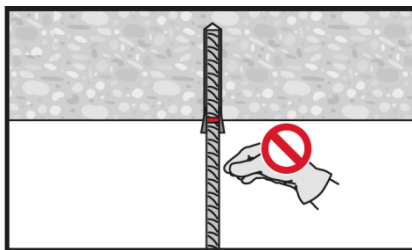
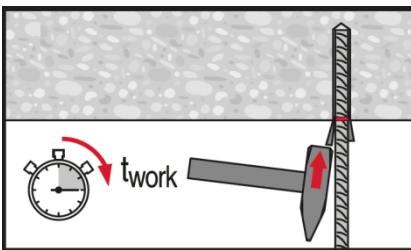

**Setting element for overhead applications, observe working time "t<sub>work</sub>".**

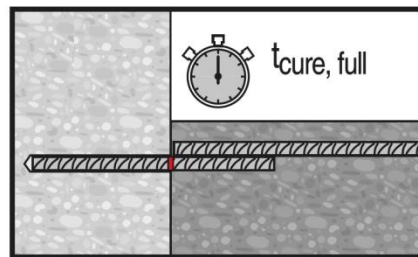
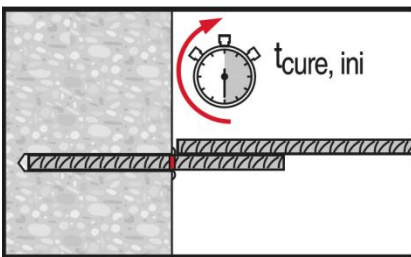

**Apply full load only after curing time "t<sub>cure</sub>".**



# HIT-MM Plus injection mortar

Anchor design (ETAG 001) / Rods&Sleeves / Concrete

## Injection mortar system



Hilti HIT-MM Plus  
300 ml foil pack  
(also available as  
500 ml foil pack)

## Benefits

- Chemical injection fastening
- Two component hybrid mortar
- Rapid curing
- Suitable for overhead fastenings
- Versatile and conventional handling
- Clean and simple in use
- Small edge distance and anchor spacing
- Always correct mixing ratio



Anchor rods:  
HIT-V  
HIT-V-F  
HIT-V-R  
(M8-M24)



Anchor rods:  
HAS-(E)  
HAS-(E)R  
(M8-M24)



Internally threaded  
sleeves:  
HIS-N  
(M8-M16)

## Base material



Concrete  
(non-cracked)



Dry concrete

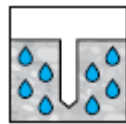

Wet concrete

## Load conditions

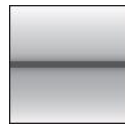

Static/  
quasi-static

## Installation conditions

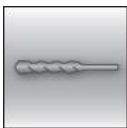

Hammer  
drilling

## Other information

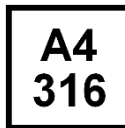

Corrosion  
resistance



Technical  
Approval

## Approvals / certificates

Description	Authority / Laboratory	No. / date of issue
European Technical Assessment <sup>a)</sup>	DIBt, Berlin	ETA-17/0199 / 2017-04-03
Hilti Technical Data <sup>b)</sup>	Hilti	2019-09-23

a) All data given in this section according to ETA 17/0199 (issued 2017-04-03).

b) All data given in this section according to Hilti Technical Data.

## Basic loading data (for a single anchor)

### Data in this section applies to:

- Correct setting (See setting instruction)
- No edge distance and spacing influence
- Steel failure
- Base material thickness, as specified in the table
- One typical embedment depth, as specified in the table
- One anchor material, as specified in the tables
- Non-cracked concrete C 20/25,  $f_{ck,cube} = 25 \text{ N/mm}^2$
- Temperate range I  
(min. base material temperature  $-40^\circ\text{C}$ , max. long term/short term base material temperature:  $+24^\circ\text{C}/40^\circ\text{C}$ )

### Embedment depth and base material thickness for HIT-V and HAS-(E) rods

Threaded rods			M8	M10	M12	M16	M20	M24
Embedment depth	$h_{ef}$	[mm]	80	90	110	125	170	210
Base material	$h$	[mm]	110	120	140	161	214	266

### Recommended loads <sup>a)</sup> for HIT-V and HAS-(E) rods

Threaded rods			M8	M10	M12	M16	M20	M24
Tension	$N_{Rec}$	[kN]	5,0	7,0	10,0	12,0	15,0	18,0

a) The data provided in the table is intended for product comparison only and not suitable for the complete design of an anchorage.

## Materials

### Material quality for HIT-V

Part	Material
<b>Zinc coated steel</b>	
Threaded rod, HIT-V 5.8 (F) HAS-(E)	Strength class 5.8; Elongation at fracture A5 > 8% ductile Electroplated zinc coated $\geq 5\mu\text{m}$ ; (F) hot dip galvanized $\geq 45\mu\text{m}$
Threaded rod, HIT-V 8.8 (F) HAS-(E)R	Strength class 8.8; Elongation at fracture A5 > 12% ductile Electroplated zinc coated $\geq 5\mu\text{m}$ ; (F) hot dip galvanized $\geq 45\mu\text{m}$
Washer	Electroplated zinc coated $\geq 5\mu\text{m}$ , hot dip galvanized $\geq 45\mu\text{m}$
Nut	Strength class of nut adapted to strength class of threaded rod. Electroplated zinc coated $\geq 5\mu\text{m}$ , hot dip galvanized $\geq 45\mu\text{m}$
<b>Stainless Steel</b>	
Threaded rod, HIT-V-R	Strength class 70 for $\leq \text{M24}$ and strength class 50 for $> \text{M24}$ ; Elongation at fracture A5 > 8% ductile Stainless steel 1.4401; 1.4404; 1.4578; 1.4571; 1.4439; 1.4362
Washer	Stainless steel 1.4401, 1.4404, 1.4578, 1.4571, 1.4439, 1.4362 EN 10088-1:2014
Nut	Stainless steel 1.4401, 1.4404, 1.4578, 1.4571, 1.4439, 1.4362 EN 10088-1:2014

### Material quality for HIS-N

Part	Material	
HIS-N	Internal threaded sleeve	C-steel 1.0718; Steel galvanized $\geq 5\mu\text{m}$
	Screw 8.8	Strength class 8.8, A5 > 8 % Ductile; Steel galvanized $\geq 5\mu\text{m}$
HIS-RN	Internal threaded sleeve	Stainless steel 1.4401, 1.4571
	Screw 70	Strength class 70, A5 > 8 % Ductile Stainless steel 1.4401; 1.4404, 1.4578; 1.4571; 1.4439; 1.4362

## Setting information

**Installation temperature range:**  
0°C to +40°C

### In service temperature range

Hilti HIT-HY MM+ injection mortar with anchor rods may be applied in the temperature ranges given below. An elevated base material temperature leads to a reduction of the design bond resistance.

Temperature range	Base material temperature	Max. long term base material temperature	Max. short term base material temperature
Temperature range	-40 °C to + 40 °C	+ 24 °C	+ 40 °C

### Max. short term base material temperature

Short term elevated base material temperatures are those that occur over brief intervals, e.g. as a result of diurnal cycling.

### Max. long term base material temperature

Long term elevated base material temperatures are roughly constant over significant periods of time.

### Working time and curing time

Temperature of the base material T	Working time $t_{gel}$	Minimum curing time $t_{cure}^{1)}$
0 °C	10 min	4 h
0 °C < TBM < 5 °C	10 min	2.5 h
5 °C < TBM ≤ 10 °C	8 min	1.5 h
10 °C < TBM ≤ 20 °C	5 min	45 min
20 °C < TBM ≤ 30 °C	3 min	30 min
30 °C < TBM ≤ 40 °C	2 min	20 min

1) The curing time data are valid for dry base material only. In wet base material, the curing times must be doubled.

### Setting details for HIT-V / HAS

Threaded rods	M8	M10	M12	M16	M20	M24
Nominal diameter of $d_0$ [mm]	10	12	14	18	22	28
Effect. anchorage $h_{ef}$ [mm]	80	90	110	125	170	210
Min. base material $h_{min}$ [mm]	110	120	140	161	214	266
Diameter of clearance hole in $d_f$ [mm]	9	12	14	18	22	26
Minimum spacing $s_{min}$ [mm]	40	50	60	80	100	120
Minimum edge $c_{min}$ [mm]	40	50	60	80	100	120
Torque moment $T_{max}$ [Nm]	10	20	40	80	150	200

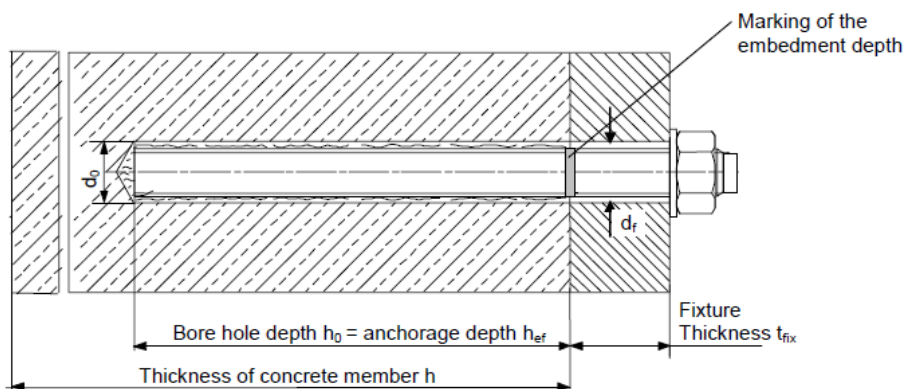



### Setting details for HIS-N

Anchor size			M8	M10	M12	M16
Nominal diameter of drill bit	$d_0$	[mm]	14	18	22	28
Diameter of element	$d$	[mm]	12,5	16,5	20,5	25,4
Effective anchorage depth	$h_{ef}$	[mm]	12,5	16,5	20,5	170
Minimum base material thickness	$h_{min}$	[mm]	120	146	169	226
Diameter of clearance hole in the fixture	$d_f$	[mm]	9	12	14	18
Thread engagement length; min – max	$h_s$	[mm]	8-20	10-25	12-30	16-40
Torque moment	$T_{max}$	[Nm]	10	20	40	80
Minimum spacing	$s_{min}$	[mm]	60	75	90	115
Minimum edge distance	$c_{min}$	[mm]	40	45	55	65

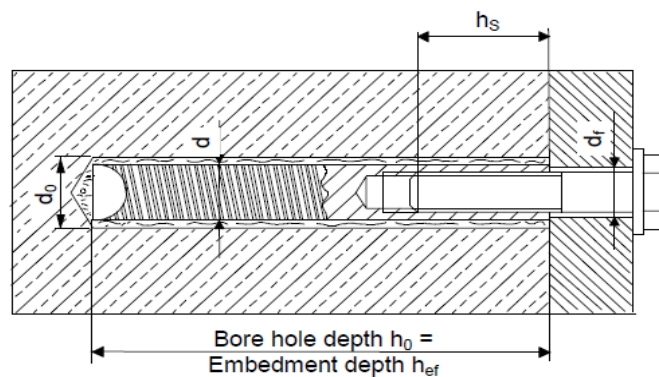

### Installation equipment

Anchor size	M8	M10	M12	M16
Rotary hammer	TE2 – TE16			
Other tools	blow out pump, set of cleaning brushes, dispenser			

### Drilling and cleaning parameters

HIT-V HAS	HIS-N	Hammer drill	Brush HIT-RB	Piston plug HIT-SZ
		$d_0$ [mm]	size [mm]	
M8	-	10	10	-
M10	-	12	12	12
M12	M8	14	14	14
M16	M10	18	18	18
-	M12	22	22	22
-	M16	28	28	28



## Setting instructions

\*For detailed information on installation see instruction for use given with the package of the product.



### Safety regulations.

Review the Material Safety Data Sheet (MSDS) before use for proper and safe handling! Wear well-fitting protective goggles and protective gloves when working with Hilti HIT-MM Plus.

### Drilling

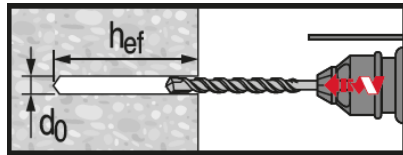

Hammer drilled hole (HD)

### Cleaning

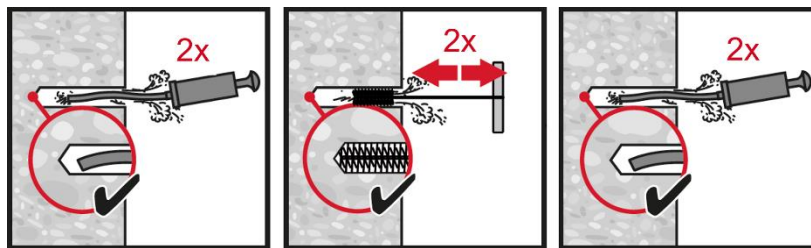

Manual cleaning (MC)  
Non-cracked concrete only

for drill diameters  $d_0 \leq 18$  mm and drill hole depth  $h_0 \leq 10 \cdot d_0$ .

### Injection system

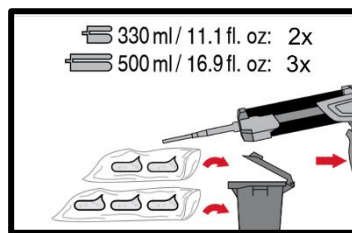
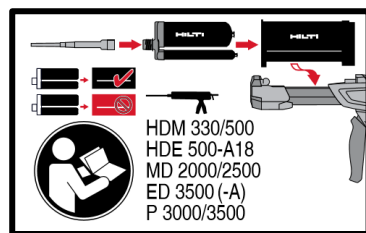

Injection system preparation.

### Injection system

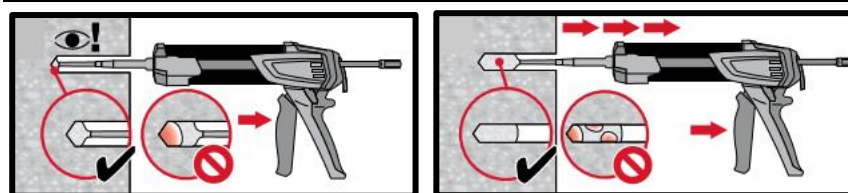

Injection method for drill hole depth

$h_{ef} \leq 250$  mm.

### Setting the element

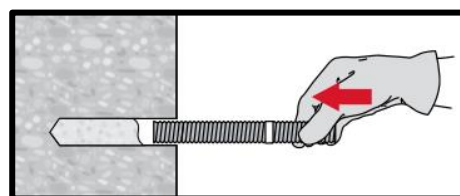

Setting element, observe working time " $t_{work}$ ",

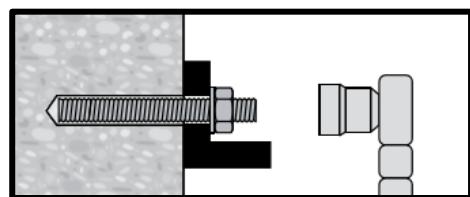

Loading the anchor after required curing time  $t_{cure}$  the anchor can be loaded. The applied installation torque shall not exceed  $T_{max}$ .

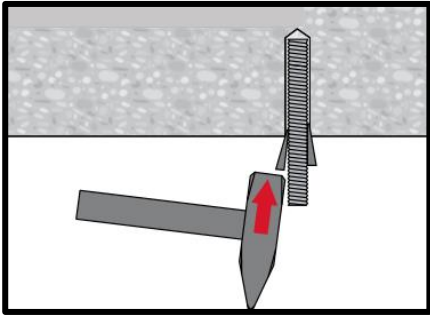

**Setting element** for overhead applications, observe working time “ $t_{work}$ ”

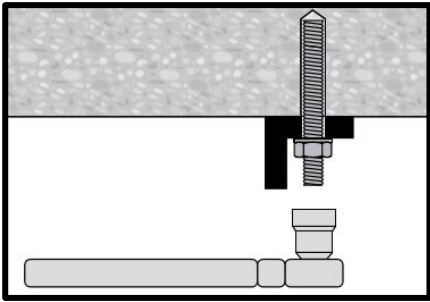

**Loading the anchor** after required curing time  $t_{cure}$  the anchor can be loaded. The applied installation torque shall not exceed  $T_{max}$ .

# HIT-MM Plus injection mortar

Anchor design (ETAG 029) / Rods&Sleeves / Masonry

## Injection mortar system

## Benefits



Hilti HIT-MM Plus

300 ml foil pack  
(also available as 500 ml foil pack)



Anchor rods:  
HIT-V  
HIT-V-R rods  
(M8-M12)



Anchor rods:  
HAS  
HAS-E rods  
(M8-M16)



Anchor rods:  
HIT-IC  
(M6-M12)



Internally threaded sleeves:  
HIS-N  
HIS-RN sleeves  
(M8-M12)

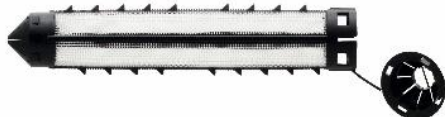

Sieve sleeves:  
HIT-SC  
(16-22)

- Chemical injection fastening for all type of base materials:
- Hollos and solid clay bricks, sand-lime bricks, normal and light weight concrete blocks, aereated light weight concrete, natural stones
- Two component hybrid mortar
- Rapid curing
- Flexible setting depth and fastening thickness
- Suitable for overhead fastenings
- Versatile and conventional handling
- Clean and simple in use
- Small edge distance and anchor spacing
- Always correct mixing ratio

## Base material

## Load conditions



Solid brick

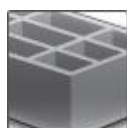

Hollow brick



Static/  
quasi-static

## Installation conditions

## Other information

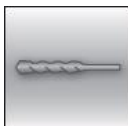

Hammer /  
rotary drilling

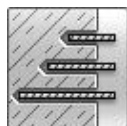

Variable  
embedment  
depth

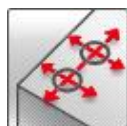

Small edge  
distance and  
spacing

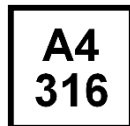

Corrosion  
resistance



European  
Technical  
Approval

## Approvals / certificates

Description	Authority / Laboratory	No. / date of issue
European Technical Assessment <sup>a)</sup>	DIBt, Berlin	ETA-16/0239 / 2016-04-21



c) All data given in this section according to ETA-16/0239 (issued 2016-04-21).

## Static and quasi-static loading (for a single anchor)

### All data in this section applies to:

- Load values valid for holes drilled with TE rotary hammers in hammering (solid bricks) / rotary (hollow bricks) mode.
- Correct anchor setting (see instruction for use, setting details)
- Steel quality of fastening elements: see data below
- Steel quality for screws for HIT-IC and HIS-N: min. grade 5.8 / HIS-RN: A4-70
- Threaded rods of appropriate size (diameter and length) and a minimum steel quality of 5.6 can be used

### Recommended loads $F_{rec}$ <sup>b)</sup> for pull-out failure in [kN]

Anchor size		HAS / HAS-E / HIT-V				HIT-IC		
		M8	M10	M12	M8	M10	M12	
<b>Solid Masonry</b>								
<b>Solid clay brick Mz12/2,0</b> DIN 105/ EN 771-1 $f_{b a)} \geq 12 \text{ N/mm}^2$ 	Setting depth [mm]	80	80	80	80	80	80	80
	$F_{rec}$ [kN]	0,9	1,5	1,5	0,9	1,5	1,5	
<b>Hollow Masonry</b>								
<b>Hlz 12</b> DIN 105/ EN 771-1 $f_{b a)} \geq 12 \text{ N/mm}^2$ 	Sieve Sleeve HIT-	16x...	16x...	18x...	22x...	16x...	16x...	16x...
	Setting depth [mm]	80	80	80	80	80	80	80
	$F_{rec}$ [kN]	0,8	0,8	0,8	0,8	0,8	0,8	0,8

a)  $f_b$  = brick strength

b) The data provided in the table is intended for product comparison only and not suitable for the complete design of an anchorage

**Due to the wide variety of bricks site tests have to be performed for determination of load values for all applications outside of the above mentioned base materials and / or setting conditions.**

## Materials

### Material quality

Part	Material
Threaded rod HIT-V, HAS-(E)	Strength class 5.8, EN ISO 898-1, A5 > 8% ductile Steel galvanized $\geq 5 \mu\text{m}$ , EN ISO 4042
Threaded rod HIT-V-R / HAS-(E)R	Stainless steel grade A4, strength class 70; A5 > 8% Ductile Stainless steel 1.4401; 1.4404; 1.4578; 1.4571; 1.4439; 1.4362 EN 10088
HIT-IC sleeve	Carbon steel; galvanized to min. 5 $\mu\text{m}$
HIS-N	C-steel 1.0718, EN 10277-3, Steel galvanized $\geq 5 \mu\text{m}$ EN ISO 4042
HIS-RN	Stainless steel 1.4401 and 1.4571 EN 10088
Washer ISO 7089	Steel galvanized EN ISO 4042 Stainless steel, EN 10088: 1.4401; 1.4404; 1.4578; 1.4571; 1.4439; 1.4362
Nut EN ISO 4032	Strength class 8 ISO 898-2 Steel galvanized $\geq 5 \mu\text{m}$ EN ISO 4042 Strength class 70 EN ISO 3506-2, stainless steel grade A4, EN 10088: Stainless steel 1.4401; 1.4404; 1.4578; 1.4571; 1.4439; 1.4362
HIT-SC sleeve	PA/PP

## Setting information

### Installation temperature range:

Solid masonry: 5°C to +40°C

Hollow masonry: -5°C to +40°C

### In service temperature range

Hilti HIT-HY MM+ injection mortar with anchor rods may be applied in the temperature ranges given below. An elevated base material temperature leads to a reduction of the design bond resistance.

Temperature range	Base material temperature	Max. long term base material temperature	Max. short term base material temperature
Temperature range I	-40 °C to + 40 °C	+ 24 °C	+ 40 °C
Temperature range II	-40 °C to + 80 °C	+ 50 °C	+ 80 °C

### Max. short term base material temperature

Short term elevated base material temperatures are those that occur over brief intervals, e.g. as a result of diurnal cycling.

### Max. long term base material temperature

Long term elevated base material temperatures are roughly constant over significant periods of time.

### Working time and curing time

Temperature of the base material	Maximum working time $t_{work}$	Minimum curing time $t_{cure}$
0 °C < $T_{BM}$ ≤ 5 °C <sup>a)</sup>	10 min <sup>a)</sup>	6 h <sup>a)</sup>
5 °C < $T_{BM}$ ≤ 10 °C	8 min	3 h
10 °C < $T_{BM}$ ≤ 20 °C	5 min	2 h
20 °C < $T_{BM}$ ≤ 30 °C	3 min	60 min
30 °C < $T_{BM}$ ≤ 40 °C	2 min	45 min

a) For hollow bricks only.

### Setting details for solid bricks

Anchor size	HIT-V			HAS / HAS-E / HAS-R			
	M8	M10	M12	M8	M10	M12	M16
Sieve sleeve HIT-SC	-	-	-	-	-	-	-
Nominal diameter of drill bit $d_0$ [mm]	10	12	14	10	12	14	18
Effective anchorage and drill hole depth $h_{ef}$ [mm]	80	80	80	80	90	110	125
Hole depth $h_0$ [mm]	85	85	85	85	95	115	130
Minimum base material thickness $h_{min}$ [mm]	115	115	115	110	120	140	170
Diameter of clearance hole in the fixture $d_f$ [mm]	9	12	14	9	12	14	18
Min. spacing $s_{min}$ [mm]	100	100	100	100	100	100	100
Min. edge distance $c_{min}$ [mm]	100	100	100	100	100	100	100
Torque moment $T_{max}$ [Nm]	5	8	10	5	8	10	10
Filing volume [ml]	4	5	7	4	6	10	15

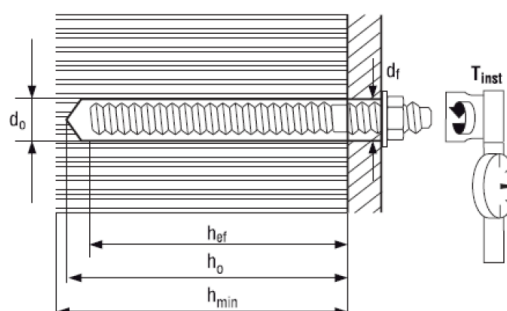

### Setting details for solid bricks

Anchor size	HIT-IC			HIS-(R)N			
	M8	M10	M12	M8	M10	M12	
Sieve sleeve	HIT-SC						-
Nominal diameter of drill bit	$d_0$ [mm]	14	16	18	14	18	22
Effective anchorage and drill hole depth	$h_{ef}$ [mm]	80	80	80	90	110	125
Hole depth	$h_0$ [mm]	85	85	85	95	115	130
Minimum base material thickness	$h_{min}$ [mm]	115	115	115	120	150	170
Diameter of clearance hole in the fixture	$d_f$ [mm]	9	12	14	9	12	14
Length of bolt engagement	$h_s$ [mm]	min. 10 – max. 75			min. 8 max. 20	min. 10 max. 25	min. 12 max. 30
Min. spacing <sup>a)</sup>	$s_{min}$ [mm]	100	100	100	100	100	100
Min. edge distance <sup>a)</sup>	$c_{min}$ [mm]	100	100	100	100	100	100
Torque moment	$T_{max}$ [Nm]	5	8	10	5	8	10
Filing volume	[ml]	6	6	6	6	10	16

**HIT-IC**

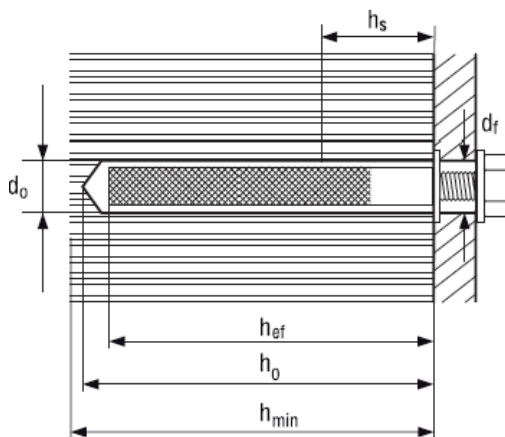

**HIS-N/RN**

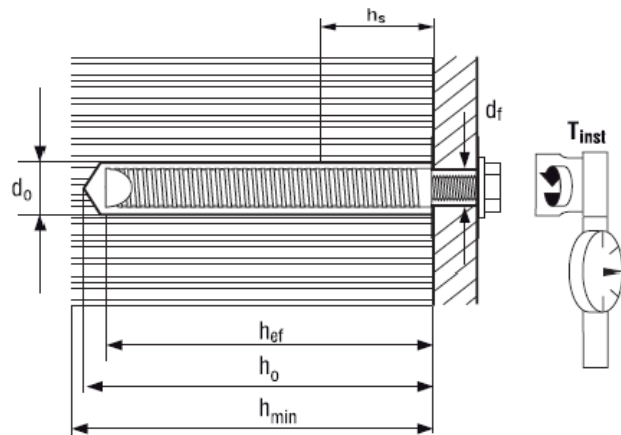

### Setting details for hollow bricks

Anchor size	HAS / HIT-V										
	M6		M8		M10		M12				
Sieve sleeve	HIT-SC										
Nominal diameter of drill bit	$d_0$ [mm]	12	12	16	16	16	16	18	18	22	22
Effective anchorage and drill hole depth	$h_{ef}$ [mm]	50	80	50	80	50	80	50	80	50	80
Hole depth	$h_0$ [mm]	60	95	60	95	60	95	60	95	60	95
Minimum base material thickness	$h_{min}$ [mm]	80	115	80	115	80	115	80	115	80	115
Diameter of clearance hole in the fixture	$d_f$ [mm]	7	7	9	9	12	12	14	14	14	14
Min. spacing <sup>a)</sup>	$s_{min}$ [mm]	100	100	100	100	100	100	100	100	100	100
Min. edge distance <sup>a)</sup>	$c_{min}$ [mm]	100	100	100	100	100	100	100	100	100	100
Torque moment	$T_{max}$ [Nm]	3	3	3	3	4	4	6	6	6	6
Filing volume	[ml]	12	24	18	30	18	30	18	36	30	55

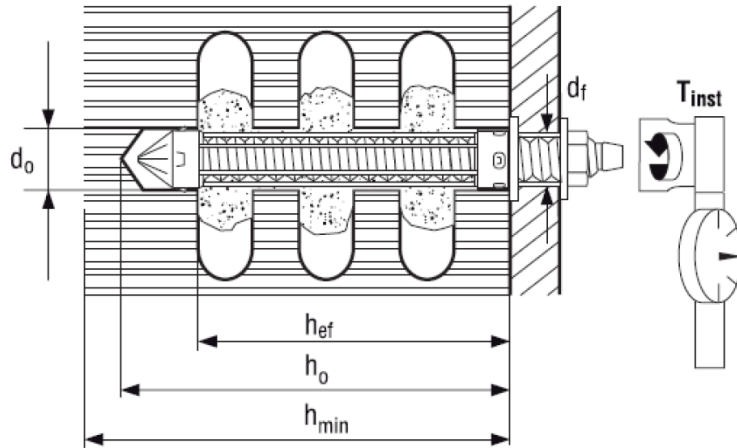
**Setting details for hollow bricks**

Anchor size		HIT-IC		
		M8	M10	M12
Sieve sleeve	HIT-SC	16x85	18x85	22x85
Nominal diameter of drill bit	$d_o$ [mm]	16	18	22
Effective anchorage and drill hole depth	$h_{ef}$ [mm]	80	80	80
Hole depth	$h_o$ [mm]	95	95	95
Minimum base material thickness	$h_{min}$ [mm]	115	115	115
Diameter of clearance hole in the fixture	$d_{fr}$ [mm]	9	12	14
Length of bolt engagement	$h_s$ [mm]	min. 10 – max. 75		
Min. spacing <sup>a)</sup>	$s_{min}$ [mm]	100	100	100
Min. edge distance <sup>a)</sup>	$c_{min}$ [mm]	100	100	100
Torque moment	$T_{max}$ [Nm]	3	4	6
Filing volume	[ml]	30	36	45

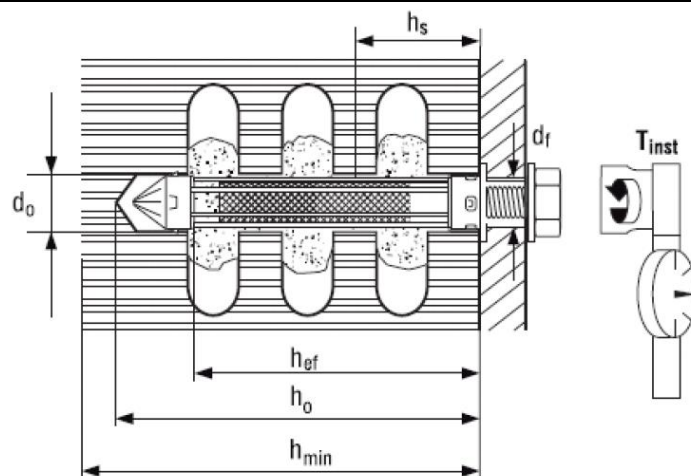



### Drilling and cleaning parameters for solid bricks

HIT-V HAS	HIT-IC	HIS-N	Hammer drill	Brush HIT-RB	Piston plug HIT-SZ
			$d_0$ [mm]	size [mm]	
M8	-	-	10	10	-
M10	-	-	12	12	12
M12	M8	M8	14	14	14
-	M10	-	16	16	16
M16 <sup>a)</sup>	M12	M10	18	18	18
-	-	M12	22	22	22

a) Only for HAS (-E) threaded rods.

### Drilling and cleaning parameters for hollow bricks

HIT-V (-R) HAS (-E) + sieve sleeve	HIT-IC + sieve sleeve	Hammer drill	Brush HIT-RB	Piston plug HIT-SZ
		$d_0$ [mm]	size [mm]	
M6	-	12	12	12
M8	-	16	16	16
M10	M8	16	16	16
M12	M10	18	18	18
M12 <sup>a)</sup>	M12	22	22	22

b) M12 with sieve sleeve SC22x50

### Setting instructions

\*For detailed information on installation see instruction for use given with the package of the product.



#### Safety regulations.

Review the Material Safety Data Sheet (MSDS) before use for proper and safe handling! Wear well-fitting protective goggles and protective gloves when working with Hilti HIT-HY MM+.

#### Drilling

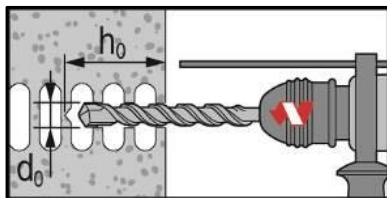

In hollow bricks: rotary mode

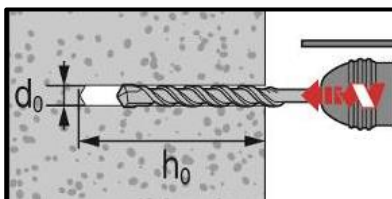

In solid bricks: hammer mode

#### Cleaning

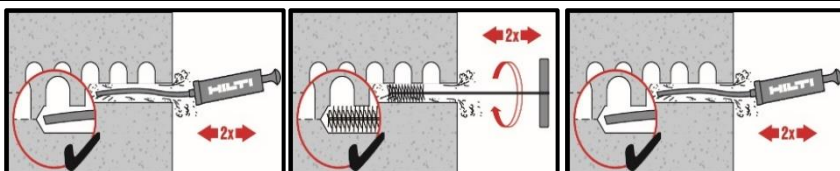

Manual cleaning (MC)

## Instructions for solid bricks without sieve sleeve

### Injection system

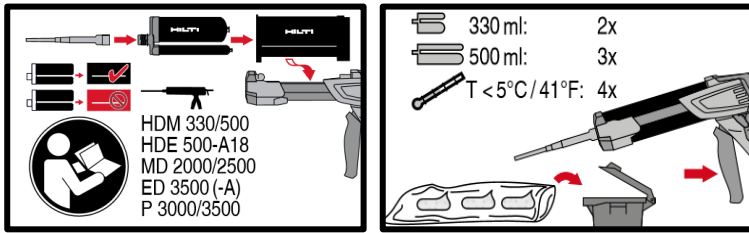

Injection system preparation.

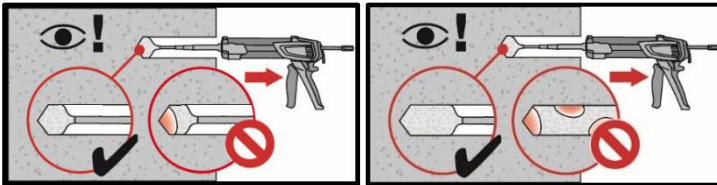

Injection method for drill hole

### Setting the element

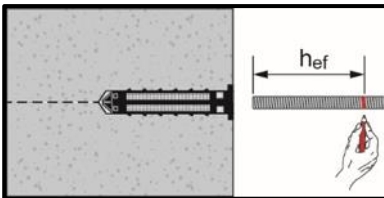

Presetting element, observe working time "t<sub>work</sub>",

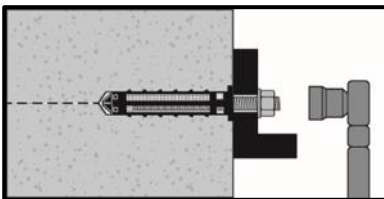

Loading the anchor: After required curing time t<sub>cure</sub> the anchor can be loaded.

## Instructions for hollow and solid bricks with sieve sleeve

### Preparation of the sieve sleeve

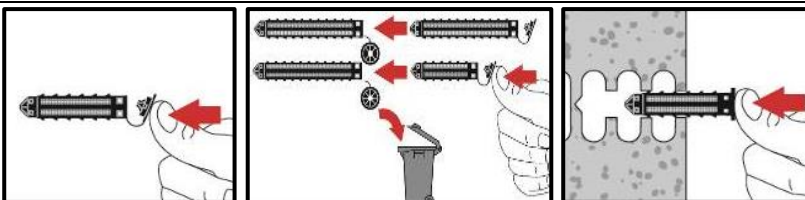

Close lid and insert sieve sleeve manually

### Injection system

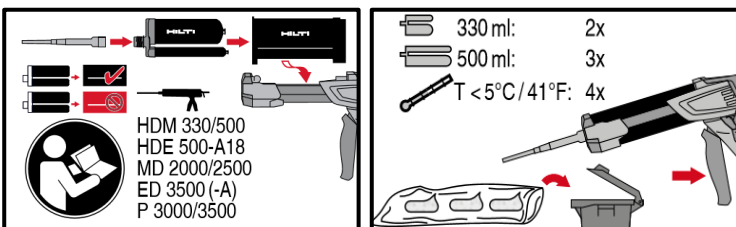

Injection system preparation.

### Injection system: hollow bricks

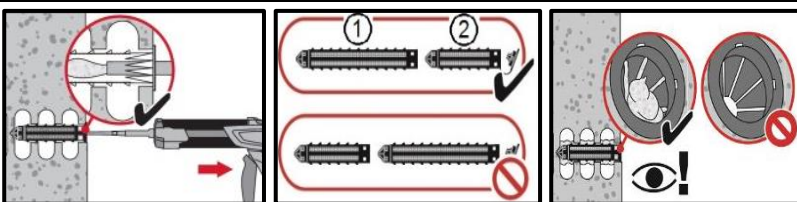

Installation with sieve sleeve HIT-SC

## Setting the element

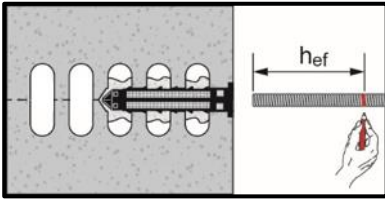

**Presetting element**, observe working time " $t_{work}$ ",

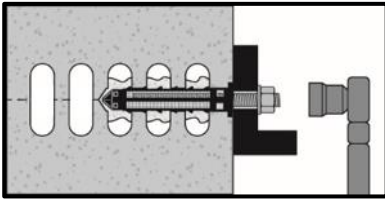

**Loading the anchor**: After required curing time  $t_{cure}$  the anchor can be loaded.

# HIT-1 / HIT-1 CE injection mortar

Anchor design (ETAG 001) / Rods&Sleeves / Concrete

## Injection mortar system



Hilti HIT-1 / HIT-1 CE  
300 ml tube cartridge



Anchor rods:  
HIT-V(F)  
HIT-V-R  
HIT-V-HCR  
(M8-M16)

## Benefits

- Chemical injection fastening
- Two-component hybrid mortar
- Rapid curing
- Suitable for overhead fastenings
- Versatile and convenient handling
- Clean and simple in use
- Small edge distance and anchor spacing
- Always correct mixing ratio
- In-service temperatures:

## Base material



Concrete  
(non-cracked)



Dry concrete

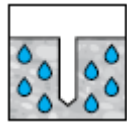

Wet concrete

## Load conditions

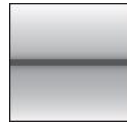

Static/  
quasi-static

## Installation conditions



Hammer  
drilling

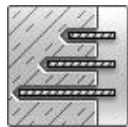

Variable  
embedment  
depth

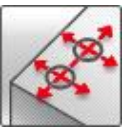

Small edge  
distance and  
spacing

## Other information



European  
Technical  
Assessment



CE  
conformity

## Approvals / certificates

Description	Authority / Laboratory	No. / date of issue
European Technical Assessment <sup>a)</sup>	TTIC, Prague	ETA-17/0005 / 2017-02-20

a) All data given in this section according to ETA-17/0005, issue 2017-02-20.

Multimerial  
 Chemical anchors  
 Mechanical anchors  
 Plastic/Light duty metal anchors  
 Insulation anchors

## Static and quasi-static loading (for a single anchor)

### All data in this section applies to

- Non-cracked concrete C 20/25,  $f_{ck,cube} = 25 \text{ N/mm}^2$
- Load values valid for holes drilled with TE rotary hammers in hammering mode
- Diamond coring is not permitted
- Correct anchor setting (see instruction for use, setting details)
- No edge distance and spacing influence
- Embedment depth, base material thickness, as specified in the tables
- Base material temperature during installation and curing must be between 0°C through +40°C
- Temperature range I and II, as specified in the tables
- *Steel* failure

### Recommended loads for tension loading

Threaded rod HIT-V 5.8		M8	M10	M12	M16
<b>Temperature range I (24/40°C)</b>					
Embedment depth	$h_{ef,min}$ [mm]	60	60	70	80
Base material thickness	$h$ [mm]	100	100	100	116
Tensile load	$N_{rec}$ [kN]	4,2	5,2	7,3	9,6
<b>Temperature range II (50/80°C)</b>					
Embedment depth	$h_{ef,10d}$ [mm]	80	100	120	160
Base material thickness	$h$ [mm]	110	130	150	196
Tensile load	$N_{rec}$ [kN]	5,6	8,7	12,6	19,2
<b>Temperature range I (24/40°C)</b>					
Embedment depth	$h_{ef,20d}$ [mm]	160	200	240	320
Base material thickness	$h$ [mm]	190	210	270	356
Tensile load	$N_{rec}$ [kN]	8,7	13,8	20,1	37,4
<b>Temperature range II (50/80°C)</b>					
Embedment depth	$h_{ef,min}$ [mm]	60	60	70	80
Base material thickness	$h$ [mm]	100	100	100	116
Tensile load	$N_{rec}$ [kN]	3,0	3,7	5,2	7,2
<b>Temperature range II (50/80°C)</b>					
Embedment depth	$h_{ef,10d}$ [mm]	80	100	120	160
Base material thickness	$h$ [mm]	110	130	150	196
Tensile load	$N_{rec}$ [kN]	4,0	6,2	9,0	14,4
<b>Temperature range II (50/80°C)</b>					
Embedment depth	$h_{ef,20d}$ [mm]	160	200	240	320
Base material thickness	$h$ [mm]	190	210	270	356
Tensile load	$N_{rec}$ [kN]	8,0	12,5	18,0	28,7

### Recommended loads for shear loading

Threaded rod HIT-V 5.8		M8	M10	M12	M16
Shear load	$V_{rec}$ [kN]	5,1	8,6	12,0	22,3

## Materials

### Mechanical properties

Anchor size		M8	M10	M12	M16
Nominal tensile strength $f_{uk}$	HIT-V 5.8	500	500	500	500
	HIT-V 8.8	800	800	800	800
	HIT-V-R	700	700	700	700
	HIT-V-HCR	800	800	800	800
Yield strength $f_{yk}$	HIT-V 5.8	400	400	400	400
	HIT-V 8.8	640	640	640	640
	HIT-V-R	450	450	450	450
	HIT-V-HCR	640	640	640	640
Stressed cross-section $A_s$	HIT-V	36,6	58,0	84,3	157
Moment of resistance $W$	HIT-V	31,2	62,3	109	277

### Material quality for HIT-V

Part	Material
<b>Zinc coated steel</b>	
Threaded rod, HIT-V 5.8 (F)	Strength class 5.8; Elongation at fracture $A_5 > 8\%$ ductile Electroplated zinc coated $\geq 5\mu\text{m}$ ; (F) hot dip galvanized $\geq 45\mu\text{m}$
Threaded rod, HIT-V 8.8 (F)	Strength class 8.8; Elongation at fracture $A_5 > 12\%$ ductile Electroplated zinc coated $\geq 5\mu\text{m}$ ; (F) hot dip galvanized $\geq 45\mu\text{m}$
Washer	Electroplated zinc coated $\geq 5\mu\text{m}$ , hot dip galvanized $\geq 45\mu\text{m}$
Nut	Strength class of nut adapted to strength class of threaded rod. Electroplated zinc coated $\geq 5\mu\text{m}$ , hot dip galvanized $\geq 45\mu\text{m}$
<b>Stainless Steel</b>	
Threaded rod, HIT-V-R	Strength class 70 for $\leq M24$ and strength class 50 for $> M24$ ; Elongation at fracture $A_5 > 8\%$ ductile Stainless steel 1.4401; 1.4404; 1.4578; 1.4571; 1.4439; 1.4362
Washer	Stainless steel 1.4401, 1.4404, 1.4578, 1.4571, 1.4439, 1.4362 EN 10088-1:2014
Nut	Stainless steel 1.4401, 1.4404, 1.4578, 1.4571, 1.4439, 1.4362 EN 10088-1:2014
<b>High corrosion resistant steel</b>	
Threaded rod, HIT-V-HCR	Strength class 80 for $\leq M20$ and class 70 for $> M20$ , Elongation at fracture $A_5 > 8\%$ ductile High corrosion resistance steel 1.4529; 1.4565;
Washer	High corrosion resistant steel 1.4529, 1.4565 EN 10088-1:2014
Nut	High corrosion resistant steel 1.4529, 1.4565 EN 10088-1:2014

## Setting information

### Installation temperature range:

+5°C to +40°C

### Service temperature range

Hilti HIT-1 / HIT-1 CE injection mortar may be applied in the temperature ranges given below. An elevated base material temperature may lead to a reduction of the design bond resistance.

Temperature range	Base material temperature	Maximum long term base material temperature	Maximum short term base material temperature
Temperature range I	-40 °C to +40 °C	+24 °C	+40 °C
Temperature range II	-40 °C to +80 °C	+50 °C	+80 °C

### Max short term base material temperature

Short-term elevated base material temperatures are those that occur over brief intervals, e.g. as a result of diurnal cycling.

### Max long term base material temperature

Long-term elevated base material temperatures are roughly constant over significant periods of time.

### Working time and curing time:

Temperature of the base material $T_{BM}$	Maximum working time $t_{work}$	Minimum curing time $t_{cure}$
$-5^{\circ}\text{C} \leq T_{BM} < 0^{\circ}\text{C}$	1,5 h	6 h
$0^{\circ}\text{C} \leq T_{BM} < 5^{\circ}\text{C}$	45 min	3 h
$5^{\circ}\text{C} \leq T_{BM} < 10^{\circ}\text{C}$	25 min	2 h
$10^{\circ}\text{C} \leq T_{BM} < 15^{\circ}\text{C}$	20 min	100 min
$15^{\circ}\text{C} \leq T_{BM} < 20^{\circ}\text{C}$	15 min	80 min
$20^{\circ}\text{C} \leq T_{BM} < 30^{\circ}\text{C}$	6 min	45 min
$30^{\circ}\text{C} \leq T_{BM} < 34^{\circ}\text{C}$	4 min	25 min
$35^{\circ}\text{C} \leq T_{BM} < 40^{\circ}\text{C}$	2 min	20 min

### Setting details

Threaded rod – size		M8	M10	M12	M16
Nominal diameter of drill bit	$d_0$ [mm]	10	12	14	18
Nominal diameter of element	$d$ [mm]	8	10	12	16
Maximum diameter of clearance hole in the fixture	$d_f$ [mm]	9	12	14	18
Diameter of steel brush	$d_0$ [mm]	10	12	14	16
Minimum base material thickness	$h_{min}$ [mm]	$h_{ef} + 30 \text{ mm} \geq 100 \text{ mm}$			$h_{ef} + 2d_0$
Effective anchorage depth (= drill hole depth) $h_{ef} = h_0$	$h_{ef,min}$ [mm]	60	60	70	80
	$h_{ef,max}$ [mm]	160	200	240	320
Minimum spacing	$s_{min}$ [mm]	40	50	60	80
Minimum edge distance	$c_{min}$ [mm]	40	50	60	80







## Installation equipment

Anchor – size	M8	M10	M12	M16
Rotary hammer	TE2(-A) – TE30(-A)			
Other tools	Blow out pump ( $h_{ef} \leq 10 \cdot d$ ) Compressed air gun <sup>b)</sup> Set of cleaning brushes <sup>c)</sup> , dispenser, piston plug			

- a) Compressed air gun with extension hose for all drill holes deeper than 250 mm (for M8 to M12) or deeper than  $20 \cdot \phi$  (for  $\phi > 12$  mm)  
b) Automatic brushing with round brush for all drill holes deeper than 250 mm (for M8 to M12) or deeper than  $20 \cdot \phi$  (for  $\phi > 12$  mm)

## Parameters of cleaning and setting tools

HIT-V	Drill and clean [mm]		Installation
	Hammer drilling	Brush HIT-RB	Piston plug HIT-SZ
			
<b>M8</b>	10	10	10
<b>M10</b>	12	12	12
<b>M12</b>	14	14	14
<b>M16</b>	18	18	18

## Setting instructions

\*For detailed information on installation see instruction for use given with the package of the product.



### Safety regulations.

Review the Material Safety Data Sheet (MSDS) before use for proper and safe handling! Wear well-fitting protective goggles and protective gloves when working with Hilti HIT-1 / HIT-1 CE.

### Drilling

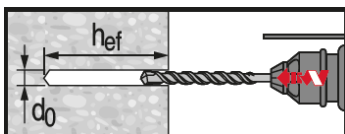

**Hammer drilled hole (HD)**  
For dry and wet concrete only

### Cleaning

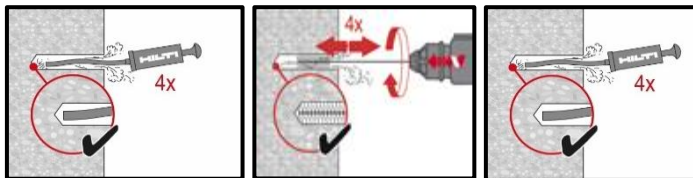

**Manual cleaning with machine brushing (MCMC)**

For drill diameters  $d_0 \leq 20$  mm and drill hole depth  $h_0 \leq 10 \cdot d$ .

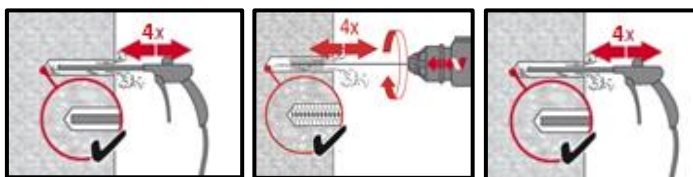

**Compressed air cleaning with machine brushing (CACMB)**

For drill diameters  $d_0$  and all drill hole depth  $h_0$ .

## Injection system

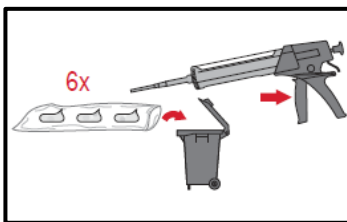
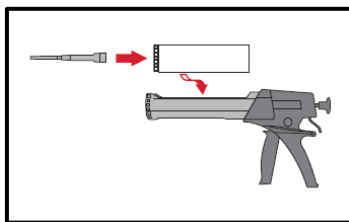

Injection system preparation

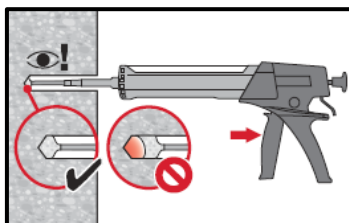

Injection method for drill hole depth (approx. 2/3 full)

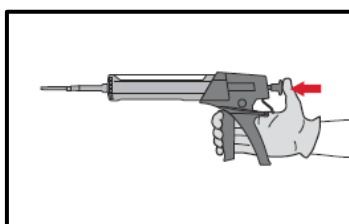

Depressurization of the dispenser.

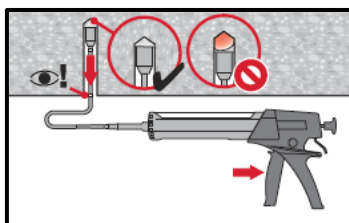

Injection method for overhead application and/or installation with embedment depth  $h_{ef} > 250$  mm.

## Setting the element

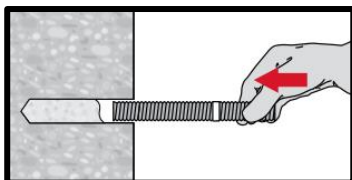

Setting the element, observe working time " $t_{work}$ ",

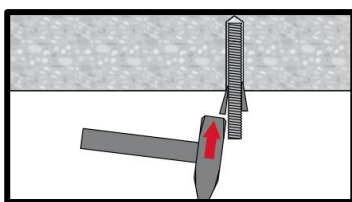

Setting element for overhead applications, observe working time " $t_{work}$ ",

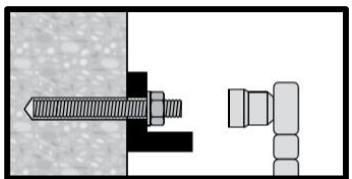

Loading the anchor: After required curing time  $t_{cure}$  the anchor can be loaded.



# HIT-1 / HIT-1 CE injection mortar

Anchor design (ETAG 029) / Rods&Sleeves / Masonry

Chemical anchors Multimerial

Mechanical anchors

Plastic/Light duty metal anchors

Insulation anchors

## Injection mortar system



Hilti HIT-1 / HIT-1 CE  
300 ml tube cartridge



Anchor rod:  
HIT-V  
HIT-V-F  
HIT-V-R  
HIT-V-HCR rods  
(M8-M12)

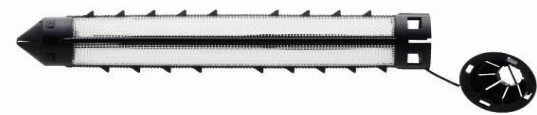

Sieve sleeve:  
HIT-SC  
(16)

## Benefits

- Hollow and solid masonry: clay bricks
- Two-component hybrid mortar
- Rapid curing
- Suitable for overhead fastenings
- Versatile and convenient handling
- Flexible setting depth and fastening thickness
- Small edge distance and anchor spacing
- Mortar filling control with HIT-SC sleeves

## Base material

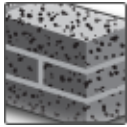

Solid bricks

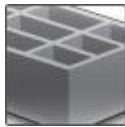

Hollow bricks

## Load conditions

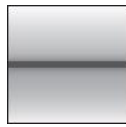

Static/  
quasi-static

## Installation conditions



Hammer/rotary  
drilling

## Approvals / certificates

Description	Authority / Laboratory	No. / date of issue
Hilti Technical Data <sup>a)</sup>	Hilti	2017-11-28

b) All data given in this section according to Hilti Technical Data.

## Static and quasi-static loading (for a single anchor)

### All data in this section applies to

- Load values valid for holes drilled with TE rotary hammers in hammer mode for solid bricks
- Load values valid for holes drilled with TE rotary hammers in rotary mode for hollow bricks
- Correct anchor setting (see instruction for use, setting details)
- Steel quality of fastening elements: see data below
- Threaded rods of appropriate size (diameter and length) and a minimum steel quality of 5.6 can be used
- Base material temperature during installation and curing must be between 0°C through +40°C

### Recommended loads for solid bricks

Anchor size			M8		M10		M12		
Sieve sleeve	HIT-SC		-	16x85	-	16x85	-	16x85	
Compressive strength	$f_b$	[N/mm <sup>2</sup> ]	28	28	28	28	28	28	
Effective anchorage depth	$h_{ef}$	[mm]	80	80	90	80	100	80	
Tensile load	40°C/24°C	$N_{rec}$	[kN]	0,7	0,9	0,7	0,9	0,7	0,9
	80°C/50°C			0,4	0,6	0,4	0,6	0,4	0,6
Shear load	$V_{rec}$	[kN]	1,3	1,3	1,7	1,6	2,5	1,7	

### Recommended loads for hollow bricks

Anchor size			M8		M10		M12		
Hollow bricks type			HZL 12	Doppio Uni	HZL 12	Doppio Uni	HZL 12	Doppio Uni	
Sieve sleeve	HIT-SC		16x85		16x85		16x85		
Compressive strength	$f_b$	[N/mm <sup>2</sup> ]	12	28	12	28	12	28	
Effective anchorage depth	$h_{ef}$	[mm]	80	80	80	80	80	80	
Tensile load	40°C/24°C	$N_{rec}$	[kN]	0,35	0,25	0,35	0,25	0,45	0,35
	80°C/50°C			0,20	0,15	0,20	0,20	0,25	0,20
Shear load	$V_{rec}$	[kN]	1,40	0,85	1,40	0,85	1,40	0,85	

Due to the wide variety of bricks, site tests have to be performed for determination of load values for all applications outside of the above mentioned base materials and/or setting conditions.

## Materials

### Material quality

Part	Material
Threaded rod HIT-V 5,8 (F)	Strength class 5,8, A5 > 8% ductile Electroplated zinc coated $\geq 5\mu\text{m}$ (F) Hot dip galvanized $\geq 45\mu\text{m}$
Threaded rod HIT-V 8,8 (F)	Strength class 8,8, A5 > 12% ductile Electroplated zinc coated $\geq 5\mu\text{m}$ (F) Hot dip galvanized $\geq 45\mu\text{m}$
Threaded rod HIT-V-R	Strength class 70 for $\leq M24$ and class 50 for $> M24$ , A5 > 8% ductile Stainless steel 1,4401; 1,4404; 1,4578; 1,4571; 1,4439; 1,4362
Threaded rod HIT-V-HCR	Strength class 70 for $\leq M24$ and class 50 for $> M24$ , A5 > 8% ductile High corrosion resistance steel 1,4528; 1,4565;
Washer	Electroplated zinc coated $\geq 5\mu\text{m}$ , hot dip galvanized $\geq 45\mu\text{m}$
	Stainless steel 1,4401, 1,4404, 1,4578, 1,4571, 1,4439, 1,4362 EN 10088-1:2014
	High corrosion resistant steel 1,4529, 1,4565 EN 10088-1:2014
Nut	Strength class of nut adapted to strength class of threaded rod, Electroplated zinc coated $\geq 5\mu\text{m}$ , hot dip galvanized $\geq 45\mu\text{m}$
	Strength class of nut adapted to strength class of threaded rod, Stainless steel 1,4401, 1,4404, 1,4578, 1,4571, 1,4439, 1,4362 EN 10088-1:2014
	Strength class of nut adapted to strength class of threaded rod, High corrosion resistant steel 1,4529, 1,4565 EN 10088-1:2014
HIT-SC sleeve	Frame: FPP 20T, Sieve: PA6,6 N500/200

**Setting information**

**Installation temperature range:**  
0°C to +40°C

**Service temperature range**

Hilti HIT-1 / HIT-1 CE injection mortar may be applied in the temperature ranges given below, An elevated base material temperature may lead to a reduction of the design bond resistance,

Temperature range	Base material temperature	Maximum long term base material temperature	Maximum short term base material temperature
Temperature range I	-40 °C to +40 °C	+24 °C	+40 °C
Temperature range II	-40 °C to +80 °C	+50 °C	+80 °C

**Working time and curing time:**

Temperature of the base material	Maximum working time $t_{work}$	Minimum curing time $t_{cure}$
$0^{\circ}\text{C} \leq T_{BM} < 5^{\circ}\text{C}$	45 min	3 h
$5^{\circ}\text{C} \leq T_{BM} < 10^{\circ}\text{C}$	25 min	2 h
$10^{\circ}\text{C} \leq T_{BM} < 20^{\circ}\text{C}$	15 min	100 min
$20^{\circ}\text{C} \leq T_{BM} < 30^{\circ}\text{C}$	6 min	45 min
$30^{\circ}\text{C} \leq T_{BM} < 40^{\circ}\text{C}$	2 min	25 min

**Setting details for solid bricks**

Anchor size	HIT-SC		M8		M10		M12	
Sieve sleeve		HIT-SC	-	16x85	-	16x85	-	16x85
Nominal diameter of drill bit	$d_o$	[mm]	10	16	12	16	14	18
Max, diameter of clearance hole in the fixture	$d_f$	[mm]	9	9	12	12	14	14
Effective anchorage depth	$h_{ef}$	[mm]	80	80	90	80	100	80
Hole depth	$h_o$	[mm]	80	95	90	95	100	95
Minimum base material thickness	$h_{min}$	[mm]	115	115	115	115	115	115
Torque moment	$T_{max}$	[Nm]	6	6	10	8	10	8

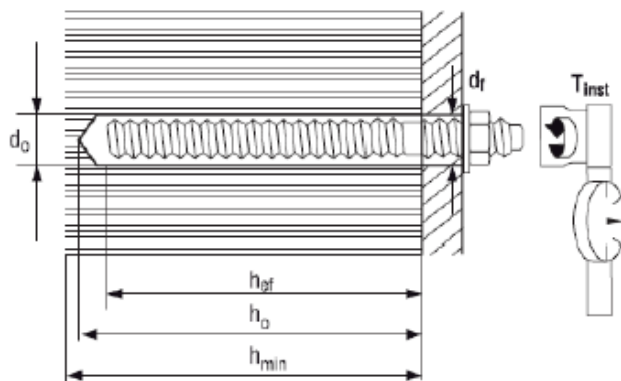

### Setting details for hollow bricks

Anchor Size	M8		M10		M12	
	HLZ2	Doppio Uni	HLZ2	Doppio Uni	HLZ2	Doppio Uni
Sieve sleeve	HIT-SC		16x85		16x85	
Nominal diameter of drill bit	$d_o$	[mm]	16	16	18	
Max, diameter of clearance hole in the fixture	$d_f$	[mm]	9	12	14	
Effective anchorage depth	$h_{ef}$	[mm]	80	80	80	
Hole depth	$h_o$	[mm]	95	95	95	
Minimum base material thickness	$h_{min}$	[mm]	115	115	115	
Torque moment	$T_{max}$	[Nm]	4	4	4	

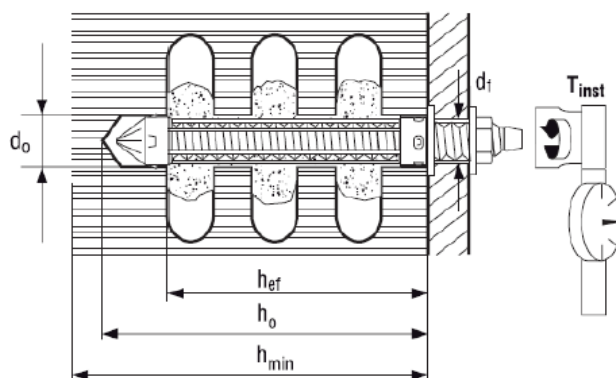

### Installation equipment

Anchor – size	M8	M10	M12
Rotary hammer	TE2(-A) – TE30(-A)		
Other tools	Blow out pump Set of cleaning brushes, dispenser		

### Cleaning and setting parameters for solid and hollow bricks

HIT-V	Sieve sleeve HIT-SC	Drill and clean [mm]	
		Hammer drilling	Brush HIT-RB
<b>M8</b> <sup>a)</sup>	-	10	10
<b>M10</b> <sup>a)</sup>	-	12	12
<b>M12</b> <sup>a)</sup>	-	14	14
<b>M8</b>	HIT-SC 16x85	16	16
<b>M10</b>	HIT-SC 16x85	16	16
<b>M12</b>	HIT-SC 18x85	18	18

a) Installation without the sieve sleeve HIT-SC can be used only in case of solid bricks.

## Setting instructions

\*For detailed information on installation see instruction for use given with the package of the product.



### Safety regulations.

Review the Material Safety Data Sheet (MSDS) before use for proper and safe handling! Wear well-fitting protective goggles and protective gloves when working with Hilti HIT-1 / HIT-1 CE.

### Drilling

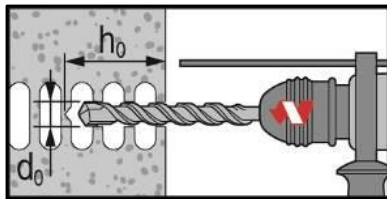

In hollow bricks: rotary mode

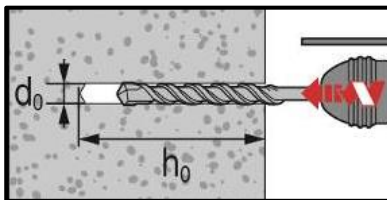

In solid bricks: hammer mode

### Cleaning

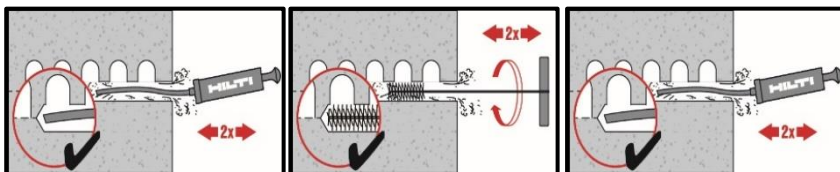

Manual cleaning (MC)

### Instructions for solid bricks without sieve sleeve

#### Injection system

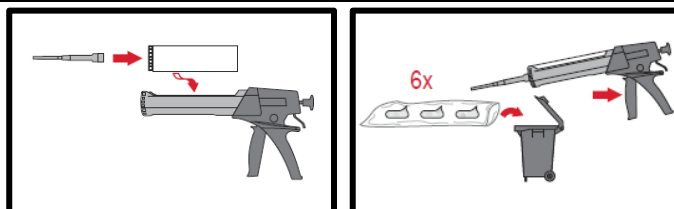

Injection system preparation.

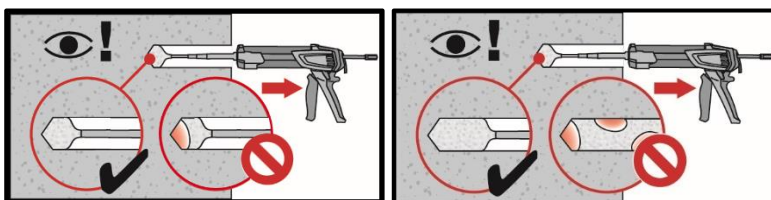

Injection method for drill hole

#### Setting the element

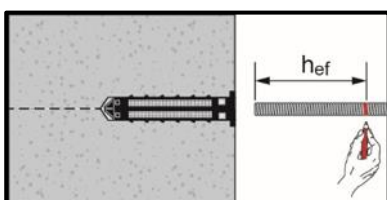

Presetting element, observe working time "t<sub>work</sub>",

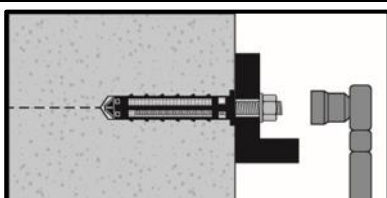

Loading the anchor: After required curing time t<sub>cure</sub> the anchor can be loaded.



**Instructions for hollow and solid bricks with sieve sleeve**

**Preparation of the sieve sleeve**

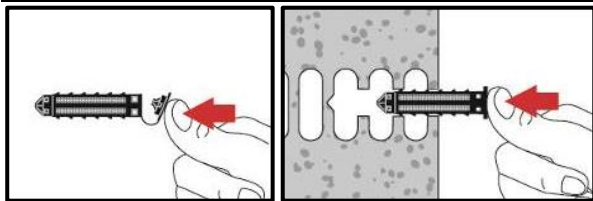

Close lid and insert sieve sleeve manually

**Injection system**

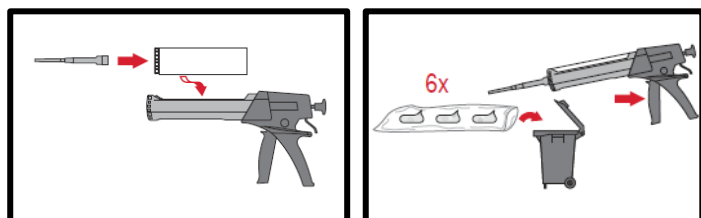

Injection system preparation.

**Injection system: hollow bricks**

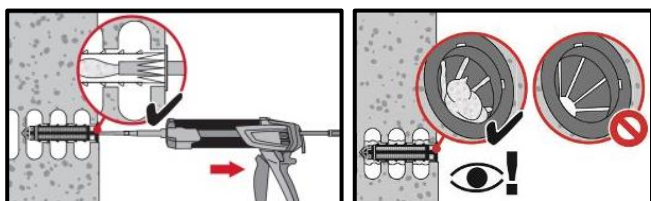

Installation with sieve sleeve HIT-SC

**Setting the element**

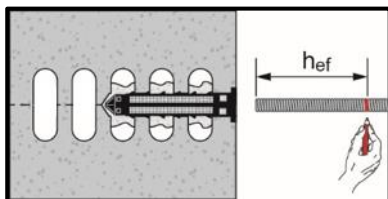

Presetting element, observe working time "t<sub>work</sub>",

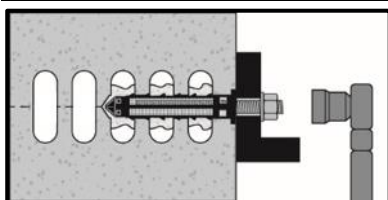

Loading the anchor: After required curing time t<sub>cure</sub> the anchor can be loaded.

# HIT-HY 270 injection mortar

Anchor design (EAD) / Rods&Sleeves / Masonry

## Injection mortar system



Hilti HIT-HY 270

330 ml foil pack  
(also available as  
500 ml foil pack)

Anchor rod:  
HIT-V  
HIT-V-F  
HIT-V-R  
HIT-V-HCR rods  
(M6-M16)

Anchor rod:  
HAS-U  
HAS-U-F  
HAS-U-R  
HAS-U-HCR rods  
(M6-M16)

Internally threaded  
sleeve:  
HIT-IC (M8-M12)

Sieve sleeves:  
HIT-SC (12-22)

## Benefits

- Chemical injection fastening for the most common types of base materials:
- Hollow and solid clay bricks, calcium silicate bricks, normal and light weight concrete blocks
- Two-component hybrid mortar
- Versatile and convenient handling with HDE dispenser
- Flexible setting depth and fastening thickness
- Small edge distance and anchor spacing
- Suitable for overhead fastenings

## Base material

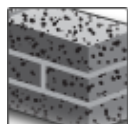

Solid brick



Hollow brick

## Load conditions



Static/  
quasi-static



Fire  
resistance

## Installation conditions

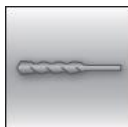

Hammer  
drill bit  
(Hammer  
mode and  
rotary mode)

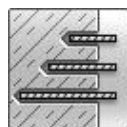

Variable  
embedment  
depth

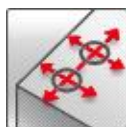

Small edge  
distance and  
spacing

## Other informations



European  
Technical  
Assessment



CE  
conformity

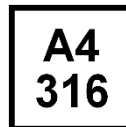

Corrosion  
resistance



High  
corrosion  
resistance



PROFIS  
Engineering  
design  
software

## Approvals / certificates

Description	Authority / Laboratory	No. / date of issue
European technical assessment	DIBt, Berlin	ETA-13/1036 / 2017-12-12
European technical assessment	DIBt, Berlin	ETA-19/0160 / 2019-04-29
Hilti Technical Data <sup>a)</sup>	Hilti	2019-05-20
Fire test report	MFPA, Leipzig	PB 3.2/14-179-1 / 2014-09-05

a) Hilti Technical Data is based on testing and assessment by Hilti following EAD 330076-00-0604, EOTA TR053 and TR054

## Brick types and properties

### Instruction to this technical data

- Identify/choose your brick (or brick type) and its geometrical/physical properties on the following tables. Information about edge and spacing criteria is available on page 5.
  - The pages referred on the last column of the table below contain the design resistance loads for pull-out failure of the anchor, brick breakout failure and local brick failure for each respective brick. Notice that the data displayed on these tables is only valid for single anchors with distance to edge such that loading capacity is not influenced by it – for other cases not covered, use PROFIS Engineering software, consult ETA-13/1036, ETA-19/0160 or contact Hilti Engineering Team.
- The resistance loads provided by this technical data manual are valid only for exact same masonry unit (hollow bricks) or for units made of the same base material with equal or higher size and compressive strength (solid bricks). For other cases, on-site tests must be performed-please consult page 18.

### Exterior brick dimensions

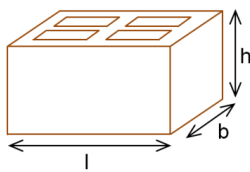

Generic bricks

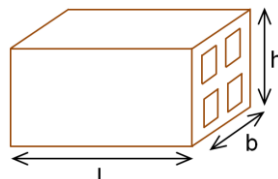

Bricks HC5, CC1 and CC2

### Interior dimensions of the majority of the holes

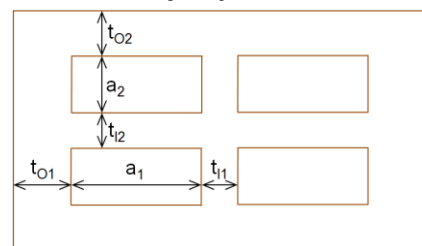

### Brick types and properties

Brick code	Data	Brick name	Image	Size [mm]	$t_0$ [mm]	$t_1$ [mm]	$a$ [mm]	$f_b$ [N/mm <sup>2</sup> ]	$\rho$ [kg/dm <sup>3</sup> ]	Page
<b>Solid clay</b>										
SC1	ETA	Solid clay brick Mz, 1DF		l: $\geq 240$ b: $\geq 115$ h: $\geq 52$	-	-	-	12 20 40	2,0	9
SC2	ETA	Solid clay brick Mz, NF		l: $\geq 240$ b: $\geq 115$ h: $\geq 72$	-	-	-	10 20	2,0	10
SC3	ETA	Solid clay brick Mz, 2DF		l: $\geq 240$ b: $\geq 115$ h: $\geq 113$	-	-	-	12 20	2,0	10
SC4	Hilti Data	UK London yellow Multi Stock		l: 215 b: 100 h: 65	-	-	-	16	1,5	11
SC5	Hilti Data	Australian common dry pressed		l: 230 b: 110 h: 76	-	-	-	25	2,0	11
<b>Hollow clay</b>										
HC1	ETA	Hollow clay brick Hz, 10DF		l: 300 b: 240 h: 238	$t_{01}$ : 12 $t_{02}$ : 15	$t_{11}$ : 11 $t_{12}$ : 15	$a_1$ : 10 $a_2$ : 25	12 20	1,4	11
HC2	Hilti Data	Italy Mattone Alveolater 50		l: 300 b: 245 h: 185	$t_{01}$ : 12 $t_{02}$ : 12	$t_{11}$ : 9 $t_{12}$ : 9	$a_1$ : 22 $a_2$ : 25	16	1,0	12
HC3	Hilti Data	Spain Termoarcilla		l: 300 b: 192 h: 190	$t_{01}$ : 9 $t_{02}$ : 9	$t_{11}$ : 7 $t_{12}$ : 7	$a_1$ : 17 $a_2$ : --	22	0,9	12
HC4	Hilti Data	Belgium Wienerberger Thermobrick		l: 285 b: 135 h: 138	$t_{01}$ : 10 $t_{02}$ : 10	$t_{11}$ : 7 $t_{12}$ : 7	$a_1$ : 14 $a_2$ : 34	21	0,9	12
HC5	Hilti Data	Spain Hueco doble		l: 232 b: 115 h: 78	$t_{01}$ : 9 $t_{02}$ : 9	$t_{11}$ : 8 $t_{12}$ : 8	$a_1$ : 28 $a_2$ : 28	4	0,8	13

Brick code	Data	Brick name	Image	Size [mm]	t <sub>0</sub> [mm]	t <sub>1</sub> [mm]	a [mm]	f <sub>b</sub> [N/mm <sup>2</sup> ]	ρ [kg/dm <sup>3</sup> ]	Page
HC6	Hilti Data	Belgium Wienerberger Powerbrick		l: 285 b: 135 h: 135	t <sub>01</sub> : 16 t <sub>02</sub> : 12	t <sub>11</sub> : 10 t <sub>12</sub> : 10	a <sub>1</sub> : 12 a <sub>2</sub> : 31	41	1,2	13
HC7	Hilti Data	Italy Doppio uni		l: 240 b: 120 h: 120	t <sub>01</sub> : 12 t <sub>02</sub> : 12	t <sub>11</sub> : 10 t <sub>12</sub> : 12	a <sub>1</sub> : 22 a <sub>2</sub> : 24	27	1,1	13
HC8	Hilti Data	Spain Ladrillo cara vista		l: 240 b: 115 h: 49	t <sub>01</sub> : 13 t <sub>02</sub> : 16	t <sub>11</sub> : 7 t <sub>12</sub> : 7	a <sub>1</sub> : 30 a <sub>2</sub> : 33	42	1,2	13
HC9	Hilti Data	Spain Clinker mediterraneo		l: 240 b: 115 h: 49	t <sub>01</sub> : 17 t <sub>02</sub> : 17	t <sub>11</sub> : 7 t <sub>12</sub> : 7	a <sub>1</sub> : 29 a <sub>2</sub> : 29	78	1,3	14
HC10	Hilti Data	UK Nostell red multi		l: 215 b: 102 h: 65	t <sub>01</sub> : 23 t <sub>02</sub> : 21	t <sub>11</sub> : 28 t <sub>12</sub> : --	a <sub>1</sub> : 38 a <sub>2</sub> : 56	70	1,6	14
HC11	Hilti Data	Australian common standard		l: 230 b: 110 h: 76	t <sub>01</sub> : 20 t <sub>02</sub> : 16	t <sub>11</sub> : 16 t <sub>12</sub> : 20	a <sub>1</sub> : 25 a <sub>2</sub> : 36	84	1,5	15
<b>Clay Ceiling</b>										
CC1	ETA	Clay ceiling brick Ds-1,0		l: 250 b: 510 h: 180	t <sub>01</sub> : 12 t <sub>02</sub> : 12	t <sub>11</sub> : 7 t <sub>12</sub> : 7	a <sub>1</sub> : 14 a <sub>2</sub> : 32	3	1,0	15
CC2	Hilti Data	Italy Mattone rosso		l: 250 b: 400 h: 180	t <sub>01</sub> : 9 t <sub>02</sub> : 9	t <sub>11</sub> : 7 t <sub>12</sub> : 7	a <sub>1</sub> : 69 a <sub>2</sub> : 55	26	0,6	15
<b>Solid Calcium Silicate</b>										
SCS1	ETA	Solid silica brick KS, 2DF		l: ≥ 240 b: ≥ 115 h: ≥ 113	-	-	-	12 28	2,0	15
SCS2	ETA	Solid silica brick KS, 8DF		l: ≥ 248 b: ≥ 240 h: ≥ 248	-	-	-	12 20 28	2,0	16
<b>Hollow Calcium Silicate</b>										
HCS1	ETA	Hollow silica brick KSL, 8DF		l: 248 b: 240 h: 238	t <sub>01</sub> : 34 t <sub>02</sub> : 22	t <sub>11</sub> : 11 t <sub>12</sub> : 20	a <sub>1</sub> : 52 a <sub>2</sub> : 52	12 20	1,4	16
HCS2	Hilti Data	Germany KSL 12		l: 240 b: 175 h: 113	t <sub>01</sub> : 18 t <sub>02</sub> : 20	t <sub>11</sub> : -- t <sub>12</sub> : --	a <sub>1</sub> : -- a <sub>2</sub> : --	12	1,6	16
<b>Solid Light weight concrete</b>										
SLWC 1	ETA	Solid lightweight concrete brick Vbl, 2DF		l: ≥ 240 b: ≥ 115 h: ≥ 113	-	-	-	4 6	0,9	17
SLWC 2	Hilti Data	Sweden Leca typ 3		l: 550 b: 190 h: 190	-	-	-	3	0,6	17
SLWC 3	Hilti Data	Italy "Tufo" volcanic rock		l: 380 b: 270 h: 270	-	-	-	4	1,2	17
<b>Hollow Light weight concrete</b>										
HLW C1	ETA	Hollow lightweight concrete brick Hbl, 16DF		l: 495 b: 240 h: 238	t <sub>01</sub> : 25 t <sub>02</sub> : 51	t <sub>11</sub> : 35 t <sub>12</sub> : 36	a <sub>1</sub> : 196 a <sub>2</sub> : 52	2 6	0,7	17

Brick code	Data	Brick name	Image	Size [mm]	t <sub>0</sub> [mm]	t <sub>1</sub> [mm]	a [mm]	f <sub>b</sub> [N/mm <sup>2</sup> ]	ρ [kg/dm <sup>3</sup> ]	Page
HLWC 2	Hilti Data	Germany Hbl 2		l: 248 b: 300 h: 248	t <sub>01</sub> : 17 t <sub>02</sub> : 21	t <sub>11</sub> : 24 t <sub>12</sub> : 22	a <sub>1</sub> : 87 a <sub>2</sub> : 40	2	0,6	18
HLWC 3	Hilti Data	Germany Hbl 4		l: 248 b: 240 h: 248	t <sub>01</sub> : 48 t <sub>02</sub> : 41	t <sub>11</sub> : -- t <sub>12</sub> : 62	a <sub>1</sub> : 140 a <sub>2</sub> : 49	4	0,7	18
<b>Solid Normal weight concrete</b>										
SNW C1	ETA	Solid normal weight concrete brick Vbn, 2DF		l: ≥ 240 b: ≥ 115 h: ≥ 113	-	-	-	6 16	2,0	18
SNW C2	Hilti Data	UK Dense Concrete b=100mm		l: 440 b: 100 h: 215	-	-	-	14	2,0	18
SNW C3	Hilti Data	UK Dense concrete b=140mm		l: 440 b: 140 h: 215	-	-	-	14	2,0	19
<b>Hollow Normal weight concrete</b>										
HNW C1	ETA	Hollow normal weight concrete brick parpaing		l: 500 b: 200 h: 200	t <sub>01</sub> : 15 t <sub>02</sub> : 15	t <sub>11</sub> : 15 t <sub>12</sub> : 15	a <sub>1</sub> : 133 a <sub>2</sub> : 75	4 10	0,9	19
HNW C2	Hilti Data	Italy Blocchi Cem		l: 500 b: 200 h: 200	t <sub>01</sub> : 30 t <sub>02</sub> : 30	t <sub>11</sub> : 30 t <sub>12</sub> : --	a <sub>1</sub> : 200 a <sub>2</sub> : 135	8	1,0	20
HNW C3	Hilti Data	Germany Hbn 4		l: 365 b: 240 h: 238	t <sub>01</sub> : 26 t <sub>02</sub> : 35	t <sub>11</sub> : 26 t <sub>12</sub> : 26	a <sub>1</sub> : 128 a <sub>2</sub> : 62	4 10	1,4	20
HNW C4	Hilti Data	UK (b=215 mm)		l: 440 b: 215 h: 215	t <sub>01</sub> : 48 t <sub>02</sub> : 48	t <sub>11</sub> : 40 t <sub>12</sub> : --	a <sub>1</sub> : 150 a <sub>2</sub> : 120	10	1,2	20
HNW C5	Hilti Data	UK (b=138 mm)		l: 440 b: 138 h: 215	t <sub>01</sub> : 48 t <sub>02</sub> : 38	t <sub>11</sub> : 48 t <sub>12</sub> : --	a <sub>1</sub> : 150 a <sub>2</sub> : 60	13	1,5	20
HNW C6	Hilti Data	UK (b=112 mm)		l: 440 b: 112 h: 215	t <sub>01</sub> : 30 t <sub>02</sub> : 30	t <sub>11</sub> : 30 t <sub>12</sub> : --	a <sub>1</sub> : 50 a <sub>2</sub> : 50	7	1,3	20
HNW C7	Hilti Data	Finland Standard concrete brick		l: 600 b: 500 h: 92	t <sub>01</sub> : 32 t <sub>02</sub> : 15	t <sub>11</sub> : 32 t <sub>12</sub> : --	a <sub>1</sub> : 62 a <sub>2</sub> : 62	6	0,9	21
HNW C8	Hilti Data	Australian block system 200		l: 390 b: 190 h: 190	t <sub>01</sub> : 30 t <sub>02</sub> : 30	t <sub>11</sub> : 30 t <sub>12</sub> : --	a <sub>1</sub> : 150 a <sub>2</sub> : 130	15	1,1	21



## Anchor installation parameters

### Brick position:

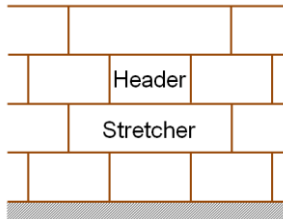

- **Header (H):** The longest dimension of the brick represents the width of the wall
- **Stretcher (S):** The longest dimension of the brick represents the length of the wall

### Spacing and edge distance:

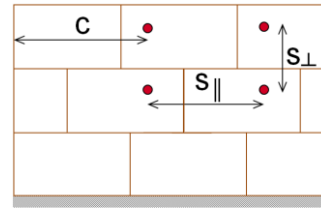

- c - Distance to the edge
- s<sub>||</sub> - Spacing parallel to the bed joint
- s<sub>⊥</sub> - Spacing perpendicular to the bed joint

### Allowed anchor positions:

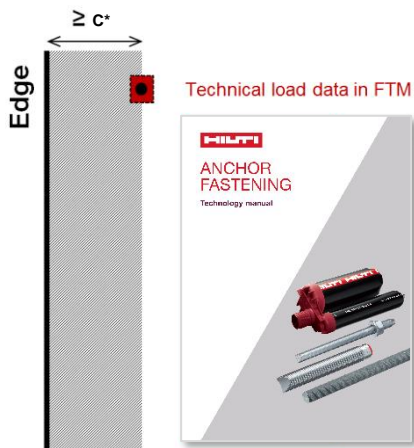

- This FTM includes the load data for single anchors in masonry with a distance to edge equal to or greater than **c\***.
- **c\*** is the distance from the anchor to the edge of the wall, such that the loading capacity of the anchor is not influenced by the edge.
- Minimum spacing between anchors = MAX (3 x h<sub>ef</sub>; size of brick in respective direction). This applies for a (conservative) manual design/calculation of a baseplate using the load tables in this manual.
- For an optimized design or cases not covered in this technical data, including anchor groups, please use PROFIS Engineering software or consult ETA-13/1036.

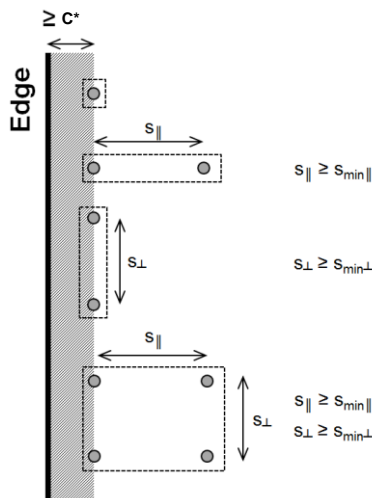

### PROFIS Engineering software interface:

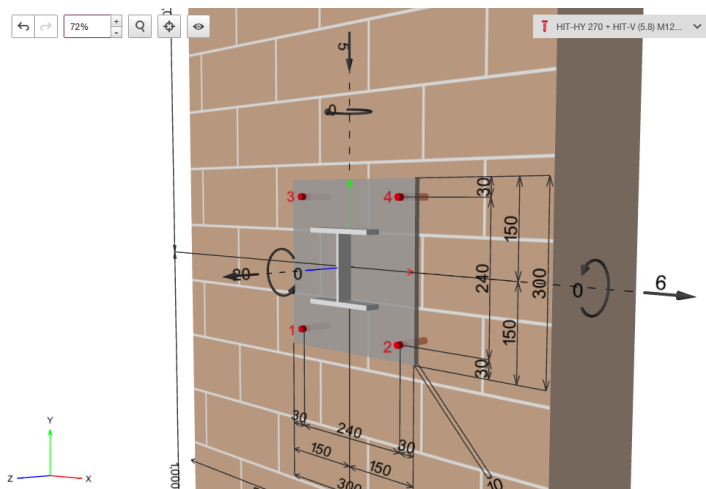

### Anchor dimensions for HIT-V and HAS-U

Anchor size		M6	M8	M10	M12	M16
Embedment depth	with HIT-SC	Variable length from 50 to 160				
	without HIT-SC	Variable length from 50 to 300				

### Anchor dimensions for HIT-IC

Anchor size		M8x80	M10x80	M12x80
Embedment depth	$h_{ef}$ [mm]	80	80	80

### Design

- Anchorages are designed under the responsibility of an engineer experienced in anchorages and masonry work.
- Verifiable calculation notes and drawings are prepared taking account of the loads to be anchored. The position of the anchor is indicated on the design drawings (e.g. position of the anchor relative to supports, etc.).
- Anchorages under static or quasi-static loading are designed in accordance with: EOTA TR054, Design method A

### Basic loading data (for a single anchor)

The load tables provide the design resistance values for a single loaded anchor.

### All data in this section applies to

- Edge distance  $c \geq c^*$ . For other applications, use Hilti PROFIS Engineering software.
- Correct anchor setting (see instruction for use, setting details)

Anchorages subject to:		Hilti HIT-HY 270 with HIT-V, HAS-U or HIT-IC	
		in solid bricks	in hollow bricks
Hole drilling		hammer mode	rotary mode
Use category: dry or wet structure		Category <b>d/d</b> - <b>Installation and use</b> in structures subject to <b>dry</b> , internal conditions, Category <b>w/d</b> - <b>Installation</b> in dry or <b>wet</b> substrate and <b>use</b> in structures subject to <b>dry</b> , internal conditions (except calcium silicate bricks), Category <b>w/w</b> - <b>Installation and use</b> in structures subject to dry or <b>wet</b> environmental conditions (except calcium silicate bricks).	
Installation direction	Masonry	horizontal	
Installation direction	Ceiling brick	overhead	
Temperature in the base material at installation		+5° C to +40° C	-5° C to +40° C (HIT-V or HIT-IC) 0° C to +40° C (HAS-U)
In-service temperature	Temperature range Ta:	-40 °C to +40 °C	(max. long term temperature +24 °C and max. short term temperature +40 °C)
	Temperature range Tb:	-40 °C to +80 °C	(max. long term temperature +50 °C and max. short term temperature +80 °C)



## Design – Failure modes

The design tensile resistance is the lower value of:

Failure due to tension loads		Condition
Failure of the metal part		$N_{Sd}^h \leq N_{Rd,s} = N_{Rk,s} / \gamma_{Ms}$
Pull-out failure of the anchor		$N_{Sd}^h \leq N_{Rd,p} = N_{Rk,p} / \gamma_{Mm}$
Brick breakout failure		$N_{Sd} \leq N_{Rd,b} = N_{Rk,b} / \gamma_{Mm}$ $N_{Sd}^g \leq N_{Rd}^g = N_{Rk}^g / \gamma_{Mm}$
Pull out of one brick		$N_{Sd} \leq N_{Rd,pb} = N_{Rk,pb} / \gamma_{Mm}$

The design shear resistance is the lower value of:

Failure due to shear loads		Condition
Failure of the metal part		$V_{Sd}^h \leq V_{Rd,s} = V_{Rk,s} / \gamma_{Ms}$
Local brick failure		$V_{Sd} \leq V_{Rd,b} = V_{Rk,b} / \gamma_{Mm}$ $V_{Sd}^g \leq V_{Rd}^g = V_{Rk}^g / \gamma_{Mm}$
Brick edge failure		$V_{Sd} \leq V_{Rd,c} = V_{Rk,c} / \gamma_{Mm}$ $V_{Sd}^g \leq V_{Rd}^g = V_{Rk}^g / \gamma_{Mm}$
Pushing out of one brick		$V_{Sd} \leq V_{Rd,pb} = V_{Rk,pb} / \gamma_{Mm}$

- Notice that loads are affected by a series of factors such as visibility/filling of joints, factors for anchor groups, spacing and edge distance.
- For other applications not covered in this FTM, use Hilti PROFIS Engineering software.

### Partial safety factors

Base material	Failure (rupture) mode - Injection Anchor ( $\gamma_{Mm}$ )
Masonry	2,5

Failure (rupture) mode - Metal part ( $\gamma_{Ms}$ )		
Tension loading	Shear loading	
	if $f_{uk} \leq 800 \text{ N/mm}^2$ and $f_{yk}/f_{uk} \leq 0,8$	if $f_{uk} > 800 \text{ N/mm}^2$ or $f_{yk}/f_{uk} > 0,8$
$1,2 / (f_{yk} / f_{uk}) \geq 1,4$	$1,0 / (f_{yk} / f_{uk}) \geq 1,25$	1,5

**Design tension and shear resistances – Steel failure for threaded rods HIT-V and HAS-U**

Anchor size		M6	M8	M10	M12	M16
N <sub>Rd,s</sub>	HIT-V 5.8(F) HAS-U 5.8(F)	6,7	12,0	19,3	28,0	52,7
	HIT-V 8.8(F) HAS-U 8.8(F)	10,7	19,3	30,7	44,7	84,0
	HIT-V-R HAS-U-R	7,5	13,9	21,9	31,6	58,8
	HIT-V-HCR HAS-U-HCR	10,7	19,3	30,7	44,7	84,0
V <sub>Rd,s</sub>	HIT-V 5.8(F) HAS-U 5.8(F)	4,0	7,2	12,0	16,8	31,2
	HIT-V 8.8(F) HAS-U 8.8(F)	6,4	12,0	18,4	27,2	50,4
	HIT-V-R HAS-U-R	4,5	8,3	12,8	19,2	35,3
	HIT-V-HCR HAS-U-HCR	6,4	12,0	18,4	27,2	50,4
M <sub>Rd,s</sub>	HIT-V 5.8(F) HAS-U 5.8(F)	6,4	15,2	29,6	52,8	133,6
	HIT-V 8.8(F) HAS-U 8.8(F)	9,6	24,0	48,0	84,0	212,8
	HIT-V-R HAS-U-R	7,1	16,7	33,4	59,1	149,7
	HIT-V-HCR HAS-U-HCR	9,6	24,0	48,0	84,0	212,8

**Design tension and shear resistances – Steel failure for internally threaded rods HIT-IC**

Anchor size		M8	M10	M12
N <sub>Rd,s</sub>	HIT-IC [Nm]	3,9	4,8	9,1
V <sub>Rd,s</sub>	HIT-V 5.8 HAS-U 5.8 [Nm]	7,2	12,0	16,8
	Screw 8.8	12,0	18,4	27,2
M <sub>Rd,s</sub>	HIT-V 5.8 HAS-U 5.8 [Nm]	15,2	29,6	52,8
	Screw 8.8	24,0	48,0	84,0

**Design tension and shear resistances – Pull-out failure of the anchor, brick breakout failure and local brick failure at edge distance ( $c \geq c^*$ ) for single anchor applications**

Load type	Anchor size	$h_{ef}$ [mm]	$f_b$ [N/mm <sup>2</sup> ]	w/w and w/d		d/d		
				Ta	Tb	Ta	Tb	
Loads [kN]								
 <b>SC1 – Solid clay brick</b> <b>Mz, 1DF (ETA data)</b>								
<b><math>N_{Rd,p} = N_{Rd,b}</math></b> ( $c \geq 115$ mm)	HIT-V, HAS-U      M8, M10, M12, M16	$\geq 50$	12	0,6 (0,8 <sup>a</sup> )				
			20	0,8 (1,0 <sup>a</sup> )				
			40	1,4 (1,6 <sup>a</sup> )				
	HIT-V, HAS-U      M8, M10, M12, M16 HIT-V + HIT-SC      M8, M10, M12, M16 HAS-U + HIT-SC      M8, M10, M12, M16 HIT-IC                  M8, M10, M12 HIT-IC + HIT-SC      M8, M10, M12	$\geq 80$	12	1,0 (1,2 <sup>a</sup> )				
			20	1,4 (1,6 <sup>a</sup> )				
			40	2,2 (2,6 <sup>a</sup> )				
		$\geq 100$	12	1,4 (1,6 <sup>a</sup> )				
			20	1,8 (2,0 <sup>a</sup> )				
			40	2,8 (3,2 <sup>a</sup> )				
	<b><math>V_{Rd,b}</math></b> ( $c \geq 115$ mm)	HIT-V, HAS-U      M8, M10	$\geq 50$	12	1,0			
				20	1,2			
				40	1,6			
HIT-V, HAS-U      M12, M16		$\geq 50$	12	1,4				
			20	1,8				
			40	2,2				
HIT-V, HAS-U      M8, M10 HIT-V + HIT-SC      M8, M10 HAS-U + HIT-SC      M8, M10 HIT-IC                  M8 HIT-IC + HIT-SC      M8		$\geq 80$	12	2,0				
			20	2,4				
			40	3,0				
			40	3,0				
HIT-V, HAS-U      M12, M16 HIT-V + HIT-SC      M12, M16 HAS-U + HIT-SC      M12, M16 HIT-IC                  M10, M12 HIT-IC + HIT-SC      M10, M12		$\geq 80$	12	2,6				
			20	3,4				
			40	4,2				
			40	4,2				

a) Compressed Air Cleaning only



**Design tension and shear resistances – Pull-out failure of the anchor, brick breakout failure and local brick failure at edge distance ( $c \geq c^*$ ) for single anchor applications**



Load type	Anchor size	$h_{ef}$ [mm]	$f_b$ [N/mm <sup>2</sup> ]	w/w and w/d		d/d			
				Ta	Tb	Ta	Tb		
Loads [kN]									
<b>SC2 – Solid clay brick</b> <b>Mz, NF (ETA data)</b>									
$N_{Rd,p} = N_{Rd,b}$ ( $c \geq 50$ mm)	HIT-V, HAS-U    M8, M10, M12, M16	$\geq 50$	10	0,6 (0,6 <sup>a</sup> )					
			20	0,8 (0,8 <sup>a</sup> )					
	HIT-V, HAS-U    M8, M10, M12, M16 HIT-V + HIT-SC    M8, M10, M12, M16 HAS-U + HIT-SC    M8, M10, M12, M16	$\geq 80$	10	1,0 (1,2 <sup>a</sup> )					
			20	1,4 (1,6 <sup>a</sup> )					
$N_{Rd,p} = N_{Rd,b}$ ( $c \geq 150$ mm)	HIT-IC    M8, M10, M12 HIT-IC + HIT-SC    M8, M10, M12	$\geq 100$	10	1,6 (1,8 <sup>a</sup> )					
			20	2,2 (2,4 <sup>a</sup> )					
$V_{Rd,b II}$ ( $c \geq 50$ mm)	HIT-V, HAS-U    M8, M10, M12, M16	$\geq 50$	10	1,2					
			20	1,8					
	HIT-V, HAS-U    M8, M10, M12, M16 HIT-V + HIT-SC    M8, M10, M12, M16 HAS-U + HIT-SC    M8, M10, M12, M16 HIT-IC    M8, M10, M12 HIT-IC + HIT-SC    M8, M10, M12	$\geq 80$	10	1,6					
			20	2,2					
			HIT-V, HAS-U    M8, M10 HIT-V + HIT-SC    M8, M10 HAS-U + HIT-SC    M8, M10 HIT-IC    M8 HIT-IC + HIT-SC    M8	$\geq 80$	10	2,0			
					20	2,8			
HIT-V, HAS-U    M8, M10 HIT-V + HIT-SC    M8, M10 HAS-U + HIT-SC    M8, M10 HIT-IC    M8, M10, M12 HIT-IC + HIT-SC    M10, M12	$\geq 100$	10	3,2						
		20	4,4						
		HIT-V, HAS-U    M12, M16 HIT-V + HIT-SC    M12, M16 HAS-U + HIT-SC    M12, M16 HIT-IC    M10, M12 HIT-IC + HIT-SC    M10, M12	$\geq 80$	10	3,6				
				20	4,8				
<b>SC3 - Solid clay brick</b> <b>Mz, 2DF (ETA data)</b>									
$N_{Rd,p} = N_{Rd,b}$ ( $c \geq 115$ mm)	HIT-V, HAS-U    M8, M10, M12, M16	$\geq 50$	12	1,0 (1,2 <sup>a</sup> )					
			20	1,0 (1,2 <sup>a</sup> )					
	HIT-V, HAS-U    M8, M10, M12, M16 HIT-V + HIT-SC    M8, M10, M12, M16 HAS-U + HIT-SC    M8, M10, M12, M16	$\geq 80$	12	1,4 (1,6 <sup>a</sup> )					
			20	1,8 (2,2 <sup>a</sup> )					
	HIT-IC    M8, M10, M12 HIT-IC + HIT-SC    M8, M10, M12	$\geq 100$	12	2,4 (2,8 <sup>a</sup> )					
			20	2,8 (3,2 <sup>a</sup> )					
$V_{Rd,b}$ ( $c \geq 1,5 h_{ef}$ )	HIT-V, HAS-U    M8, M10, M12, M16	$\geq 50$	12	2,2					
			20	2,8					
	HIT-V, HAS-U    M8, M10 HIT-V + HIT-SC    M8, M10 HAS-U + HIT-SC    M8, M10 HIT-IC    M8 HIT-IC + HIT-SC    M8	$\geq 80$	12	3,2					
			20	4,0					
			HIT-V, HAS-U    M12 HIT-V + HIT-SC    M12 HAS-U + HIT-SC    M12 HIT-IC    M10 HIT-IC + HIT-SC    M10	$\geq 80$	12	4,2			
					20	4,8			

Load type	Anchor size	$h_{ef}$ [mm]	$f_b$ [N/mm <sup>2</sup> ]	w/w and w/d		d/d	
				Ta	Tb	Ta	Tb
Loads [kN]							
$V_{Rd,b}$ ( $c \geq 1,5 h_{ef}$ )	HIT-V, HAS-U	M16	≥ 80	12	4,8		
	HIT-V + HIT-SC	M16					
	HAS-U + HIT-SC	M16	20	4,8			
	HIT-IC	M12					
	HIT-IC + HIT-SC	M12					

a) Compressed Air Cleaning only





**Design tension and shear resistances – Pull-out failure of the anchor, brick breakout failure and local brick failure at edge distance ( $c \geq c^*$ ) for single anchor applications**

Load type	Anchor size	$h_{ef}$ [mm]	$f_b$ [N/mm <sup>2</sup> ]	w/w and w/d		d/d	
				Ta	Tb	Ta	Tb
Loads [kN]							
 <b>SC4 - Solid clay brick</b> <b>UK London yellow Multi Stock (Hilti data)</b>							
$N_{Rd,p} = N_{Rd,b}$ ( $c \geq 100$ mm)	HIT-V + HIT-SC	M8, M10, M12, M16	≥ 50	16	1,4 (1,6 <sup>a</sup> )		
	HAS-U + HIT-SC	M8, M10, M12, M16					
	HIT-V + HIT-SC	M8, M10	≥ 80		2,2 (2,6 <sup>a</sup> )		
	HAS-U + HIT-SC	M8, M10					
	HIT-V + HIT-SC	M12, M16			2,6 (3,0 <sup>a</sup> )		
	HAS-U + HIT-SC	M12, M16					
$V_{Rd,b}$ ( $c \geq 1,5 h_{ef}$ )	HIT-IC + HIT-SC	M8, M10, M12	≥ 50	16	2,6		
	HIT-V + HIT-SC	M8, M10					
	HAS-U + HIT-SC	M8, M10	≥ 80		3,2		
	HIT-V + HIT-SC	M12, M16					
	HAS-U + HIT-SC	M12, M16			3,2		
	HIT-V + HIT-SC	M8, M10					
	HAS-U + HIT-SC	M8, M10	≥ 80		4,8		
	HIT-V + HIT-SC	M12, M16					
HAS-U + HIT-SC	M12, M16						
HIT-IC + HIT-SC	M8, M10, M12						
 <b>SC5 - Solid clay brick</b> <b>AUS Common dry pressed (Hilti data)</b>							
$N_{Rd,p} = N_{Rd,b}$ ( $c \geq 110$ mm)	HIT-V, HAS-U	M8, M10, M12	80	25	2,6 (3,0 <sup>a</sup> )		
	HIT-IC	M8, M10, M12					
$V_{Rd,b II}$ ( $c \geq 110$ mm)	HIT-V, HAS-U	M8, M10	80	25	3,8		
	HIT-IC	M8					
	HIT-V, HAS-U	M12			4,8		
	HIT-IC	M10, M12					
 <b>HC1 - Hollow clay brick</b> <b>H1z, 10DF (ETA data)</b>							
$N_{Rd,p} = N_{Rd,b}$ ( $c \geq 150$ mm)	HIT-V + HIT-SC	M8, M10, M12, M16	≥ 80	12	2,2 (2,4 <sup>a</sup> )		
	HAS-U + HIT-SC	M8, M10, M12, M16		20	2,8 (3,2 <sup>a</sup> )		
	HIT-IC + HIT-SC	M8, M10, M12					
$V_{Rd,b II}$ ( $c \geq 300$ mm)	HIT-V + HIT-SC	M8, M10	≥ 80	12	1,8		
	HAS-U + HIT-SC	M8, M10		20	2,2		
	HIT-IC + HIT-SC	M8		12	3,8		
	HIT-V + HIT-SC	M12, M16		20	4,0		
	HAS-U + HIT-SC	M12, M16					
	HIT-IC + HIT-SC	M10, M12					



Load type	Anchor size	$h_{ef}$ [mm]	$f_b$ [N/mm <sup>2</sup> ]	w/w and w/d		d/d	
				Ta	Tb	Ta	Tb
Loads [kN]							
 <b>HC2 - Hollow clay brick</b> <b>Italy Mattone Alveolater 50 (Hilti data)</b>							
$N_{Rd,p} = N_{Rd,b}$ (c ≥ 50 mm)	HIT-V + HIT-SC	M8, M10, M12, M16	≥ 80	16	1,8 (2,0 <sup>a</sup> )		
	HAS-U + HIT-SC	M8, M10, M12, M16	≥ 80		1,8 (2,0 <sup>a</sup> )		
	HIT-IC + HIT-SC	M8, M10, M12	≥ 80	16	1,8 (2,0 <sup>a</sup> )		
	HIT-V + HIT-SC	M8, M10, M12, M16	≥ 130		2,6 (3,0 <sup>a</sup> )		
	HAS-U + HIT-SC	M8, M10, M12, M16	≥ 130	16	2,6 (3,0 <sup>a</sup> )		
	HIT-V + HIT-SC	M8, M10, M12, M16	≥ 80		1,4		
$V_{Rd,b}$ (c ≥ 150 mm)	HAS-U + HIT-SC	M8, M10, M12, M16	≥ 80	16	1,4		
	HIT-IC + HIT-SC	M8, M10, M12	≥ 80		1,4		
	HIT-V + HIT-SC	M8, M10, M12, M16	≥ 130	16	2,6		
	HAS-U + HIT-SC	M8, M10, M12, M16	≥ 130		2,6		
 <b>HC3 - Hollow clay brick</b> <b>Spain Termoarcilla (Hilti data)</b>							
$N_{Rd,p} = N_{Rd,b}$ (c <sub>cr</sub> = 50 mm)	HIT-V + HIT-SC	M8, M10, M12, M16	≥ 50	22	0,6 (0,8 <sup>a</sup> )		
	HAS-U + HIT-SC	M8, M10, M12, M16	≥ 50		0,6 (0,8 <sup>a</sup> )		
	HIT-V + HIT-SC	M8, M10, M12, M16	≥ 80	22	1,0 (1,2 <sup>a</sup> )		
	HAS-U + HIT-SC	M8, M10, M12, M16	≥ 80		1,0 (1,2 <sup>a</sup> )		
	HIT-IC + HIT-SC	M8, M10, M12	≥ 80	22	1,0 (1,2 <sup>a</sup> )		
	HIT-V + HIT-SC	M8, M10, M12, M16	≥ 50		1,8		
$V_{Rd,b}$ (c ≥ 150 mm)	HAS-U + HIT-SC	M8, M10, M12, M16	≥ 50	22	1,8		
	HIT-IC + HIT-SC	M8, M10, M12	≥ 50		1,8		
 <b>HC4 - Hollow clay brick</b> <b>Belgium Wienerberger Thermobrick (Hilti data)</b>							
$N_{Rd,p} = N_{Rd,b}$ (c ≥ 150 mm)	HIT-V + HIT-SC	M8, M10, M12, M16	≥ 50	21	0,5 (0,6 <sup>a</sup> )		
	HAS-U + HIT-SC	M8, M10, M12, M16	≥ 50		0,5 (0,6 <sup>a</sup> )		
	HIT-V + HIT-SC	M8, M10, M12, M16	≥ 80	21	2,2 (2,6 <sup>a</sup> )		
	HAS-U + HIT-SC	M8, M10, M12, M16	≥ 80		2,2 (2,6 <sup>a</sup> )		
	HIT-IC + HIT-SC	M8, M10, M12	≥ 80	21	2,2 (2,6 <sup>a</sup> )		
	HIT-V + HIT-SC	M8, M10	≥ 50		2,4		
$V_{Rd,b}$ (c ≥ 150 mm)	HAS-U + HIT-SC	M8, M10	≥ 50	21	2,4		
	HIT-V + HIT-SC	M12, M16	≥ 50		2,8		
	HAS-U + HIT-SC	M12, M16	≥ 50	21	2,8		
	HIT-IC + HIT-SC	M8, M10, M12	≥ 50		2,8		

a) Compressed Air Cleaning only

**Design tension and shear resistances – Pull-out failure of the anchor, brick breakout failure and local brick failure at edge distance ( $c \geq c^*$ ) for single anchor applications**





Load type	Anchor size	$h_{ef}$ [mm]	$f_b$ [N/mm <sup>2</sup> ]	w/w and w/d		d/d	
				Ta	Tb	Ta	Tb
Loads [kN]							
 <b>HC5 - Hollow clay brick</b> <b>Spain Hueco doble (Hilti data)</b>							
$N_{Rd,p} = N_{Rd,b}$ ( $c \geq 120$ mm)	HIT-V + HIT-SC	M8, M10, M12, M16	$\geq 50$	4	0,4		
	HAS-U + HIT-SC	M8, M10, M12, M16			0,8 (1,0 <sup>a</sup> )		
	HIT-V + HIT-SC	M8	80		1,0 (1,2 <sup>a</sup> )		
	HAS-U + HIT-SC	M8			1,4 (1,6 <sup>a</sup> )		
	HIT-IC + HIT-SC	M8, M10, M12					
$V_{Rd,b}$ ( $c \geq 120$ mm)	HIT-V + HIT-SC	M8, M10, M12, M16	$\geq 50$	4	1,2		
	HAS-U + HIT-SC	M8, M10, M12, M16					
	HIT-IC + HIT-SC	M8, M10, M12					
 <b>HC6 - Hollow clay brick</b> <b>Belgium Wienerberger Powerbrick (Hilti data)</b>							
$N_{Rd,p} = N_{Rd,b}$ ( $c \geq 50$ mm)	HIT-V + HIT-SC	M8, M10, M12, M16	$\geq 50$	41	1,6 (1,8 <sup>a</sup> )		
	HAS-U + HIT-SC	M8, M10, M12, M16	$\geq 80$		2,6 (2,8 <sup>a</sup> )		
	HIT-V + HIT-SC	M8, M10, M12, M16					
	HAS-U + HIT-SC	M8, M10, M12, M16					
$V_{Rd,b}$ ( $c \geq 150$ mm)	HIT-V + HIT-SC	M8, M10	$\geq 50$	41	2,6		
	HAS-U + HIT-SC	M8, M10			4,8		
	HIT-V + HIT-SC	M12, M16					
	HAS-U + HIT-SC	M12, M16					
 <b>HC7 - Hollow clay brick</b> <b>Italy Doppio uni (Hilti data)</b>							
$N_{Rd,p} = N_{Rd,b}$ ( $c \geq 50$ mm)	HIT-V + HIT-SC	M8, M10, M12, M16	$\geq 50$	27	0,6		
	HAS-U + HIT-SC	M8, M10, M12, M16	$\geq 80$		1,0 (1,2 <sup>a</sup> )		
	HIT-V + HIT-SC	M8, M10, M12, M16	$\geq 130$		2,8 (3,2 <sup>a</sup> )		
	HAS-U + HIT-SC	M8, M10, M12, M16					
$V_{Rd,b}$ ( $c \geq 150$ mm)	HIT-V + HIT-SC	M8, M10, M12, M16	$\geq 50$	27	1,6		
	HAS-U + HIT-SC	M8, M10, M12, M16	$\geq 80$		3,6		
	HIT-V + HIT-SC	M8, M10, M12, M16					
	HAS-U + HIT-SC	M8, M10, M12, M16					
 <b>HC8 - Hollow clay brick</b> <b>Spain Ladrillo cara vista (Hilti data)</b>							
$N_{Rd,p} = N_{Rd,b}$ ( $c \geq 115$ mm)	HIT-V + HIT-SC	M8, M10, M12, M16	$\geq 50$	42	0,6 (0,8 <sup>a</sup> )		
	HAS-U + HIT-SC	M8, M10, M12, M16	$\geq 80$		2,2 (2,6 <sup>a</sup> )		
	HIT-V + HIT-SC	M8, M10, M12, M16					
	HAS-U + HIT-SC	M8, M10, M12, M16					
$V_{Rd,b}$ ( $c \geq 115$ mm)	HIT-V + HIT-SC	M8, M10, M12, M16	$\geq 50$	42	1,8		
	HAS-U + HIT-SC	M8, M10, M12, M16					
	HIT-IC + HIT-SC	M8, M10, M12					



Load type	Anchor size	$h_{ef}$ [mm]	$f_b$ [N/mm <sup>2</sup> ]	w/w and w/d		d/d	
				Ta	Tb	Ta	Tb
Loads [kN]							
 <b>HC9 - Hollow clay brick</b> <b>Spain Clinker mediterraneo (Hilti data)</b>							
$N_{Rd,p} = N_{Rd,b}$ (c ≥ 115mm)	HIT-V + HIT-SC	M8, M10, M12, M16	≥ 50	78	0,6 (0,8 <sup>a</sup> )		
	HAS-U + HIT-SC	M8, M10, M12, M16					
	HIT-V + HIT-SC	M8, M10, M12, M16	≥ 80		2,0 (2,2 <sup>a</sup> )		
	HAS-U + HIT-SC	M8, M10, M12, M16					
	HIT-IC + HIT-SC	M8, M10, M12					
$V_{Rd,b}$ (c ≥ 115 mm)	HIT-V + HIT-SC	M8, M10, M12, M16	≥ 50	78	2,0		
	HAS-U + HIT-SC	M8, M10, M12, M16	≥ 50				
	HIT-IC + HIT-SC	M8, M10, M12	≥ 50				
 <b>HC10 Hollow clay brick</b> <b>UK Nostell Red Multi (Hilti data)</b>							
$N_{Rd,p} = N_{Rd,b}$ (c ≥ 105 mm)	HIT-V + HIT-SC	M8, M10, M12, M16	≥ 50	70	2,4 (2,8 <sup>a</sup> )		
	HAS-U + HIT-SC	M8, M10, M12, M16					
	HIT-V + HIT-SC	M8, M10, M12, M16	≥ 80		2,8 (3,2 <sup>a</sup> )		
	HAS-U + HIT-SC	M8, M10, M12, M16					
	HIT-IC + HIT-SC	M8, M10, M12					
$V_{Rd,b}$ (c ≥ 105 mm)	HIT-V + HIT-SC	M8, M10, M12, M16	≥ 50	70	4,6		
	HAS-U + HIT-SC	M8, M10, M12, M16	≥ 50				
	HIT-V + HIT-SC	M8, M10, M12, M16	≥ 80		4,8		
	HAS-U + HIT-SC	M8, M10, M12, M16					
	HIT-IC + HIT-SC	M8, M10, M12					

a) Compressed Air Cleaning only

**Design tension and shear resistances – Pull-out failure of the anchor, brick breakout failure and local brick failure at edge distance ( $c \geq c^*$ ) for single anchor applications**

Load type	Anchor size	$h_{ef}$ [mm]	$f_b$ [N/mm <sup>2</sup> ]	w/w and w/d		d/d	
				Ta	Tb	Ta	Tb
Loads [kN]							
 <b>HC11 Hollow clay brick AUS Common standard (Hilti data)</b>							
$N_{Rd,p} = N_{Rd,b}$ ( $c \geq 110$ mm)	HIT-V + HIT-SC	M8, M10, M12, M16	$\geq 50$	84	0,6 (0,8 <sup>a</sup> )		
	HAS-U + HIT-SC	M8, M10, M12, M16					
	HIT-V + HIT-SC	M8, M10	$\geq 80$		2,6 (3,0 <sup>a</sup> )		
	HAS-U + HIT-SC	M8, M10					
HIT-IC + HIT-SC	M8		2,8 (3,2 <sup>a</sup> )				
HIT-V + HIT-SC	M12, M16						
HAS-U + HIT-SC	M12, M16						
$V_{Rd,b II}$ ( $c \geq 110$ mm)	HIT-V + HIT-SC	M8, M10	$\geq 50$	84	2,0		
	HAS-U + HIT-SC	M8, M10					
	HIT-V + HIT-SC	M12, M16	$\geq 80$		2,8		
	HAS-U + HIT-SC	M12, M16					
	HIT-V + HIT-SC	M16					
HAS-U + HIT-SC	M16		3,8				
HIT-IC + HIT-SC	M8, M10, M12						
 <b>CC1 - Ceiling Hollow clay brick "Ds-1,0" (ETA data)</b>							
$N_{Rd,p} = N_{Rd,b}$ ( $c \geq 100$ mm)	HIT-V + HIT-SC	M6	$\geq 80$	3	0,6		
	HAS-U + HIT-SC	M6					
 <b>CC2 - Ceiling Hollow clay brick Italy Mattone rosso (Hilti data)</b>							
$N_{Rd,p} = N_{Rd,b}$ ( $c \geq 100$ mm)	HIT-V + HIT-SC	M6, M8, M10, M12	$\geq 80$	26	0,6		
	HAS-U + HIT-SC	M6, M8, M10, M12					
	HIT-IC + HIT-SC	M8, M10, M12					
 <b>SCS1 - Solid silica brick KS, 2DF (ETA data)</b>							
$N_{Rd,p} = N_{Rd,b}$ ( $c \geq 115$ mm)	HIT-V, HAS-U	M8, M10, M12, M16	$\geq 50$	12	-	2,4	2,0
				28	-	3,6	3,0
	HIT-V + HIT-SC	M8, M10, M12, M16	$\geq 80$	12	-	2,4	2,0
				28	-	3,6	3,0
				HIT-IC + HIT-SC	M8, M10, M12		
$V_{Rd,b II}$ ( $c \geq 115$ mm)	HIT-V, HAS-U	M8, M10, M12, M16	$\geq 50$	12	-	2,4	
				28	-	3,6	
	HIT-V + HIT-SC	M8, M10, M12, M16	$\geq 80$	12	-	2,4	
				28	-	3,6	
HIT-IC + HIT-SC	M8, M10, M12						

a) Compressed Air Cleaning only

**Design tension and shear resistances – Pull-out failure of the anchor, brick breakout failure and local brick failure at edge distance ( $c \geq c^*$ ) for single anchor applications**

Load type	Anchor size	$h_{ef}$ [mm]	$f_b$ [N/mm <sup>2</sup> ]	w/w and w/d		d/d	
				Ta	Tb	Ta	Tb
Loads [kN]							
<b>SCS2- Solid silica brick</b> <b>KS, 8DF (ETA data)</b>							
$N_{Rd,p} = N_{Rd,b}$ ( $c \geq 120$ mm)	HIT-V, HAS-U    M8, M10, M12, M16	$\geq 50$	12	-	2,8	2,2	
			20	-	3,6	3,0	
			28	-	4,2	3,4	
	HIT-V, HAS-U    M8, M10	$\geq 80$	12	-	3,4	2,8	
			20	-	4,4	3,6	
			28	-	4,8	4,2	
	HIT-V, HAS-U    M12 HIT-V + HIT-SC    M8, M10 HAS-U + HIT-SC    M8, M10 HIT-IC                M8, M10 HIT-IC + HIT-SC    M8	$\geq 80$	12	-	4,6	3,8	
			$\geq 20$	-	4,8		
			$\geq 12$	-	4,8		
				-	4,8		
	HIT-V, HAS-U    M8, M10	$\geq 100$	12	-	4,8	4,4	
			$\geq 20$	-	4,8		
$\geq 12$			-	4,8			
HIT-V, HAS-U    M12, M16 HIT-V + HIT-SC    M8, M10, M12, M16 HAS-U + HIT-SC    M8, M10, M12, M16 HIT-IC                M8, M10, M12 HIT-IC + HIT-SC    M8, M10, M12	$\geq 100$	$\geq 12$	-	4,8			
		$\geq 20$	-	4,8			
		$\geq 12$	-	4,8			
		$\geq 12$	-	4,8			
		$\geq 12$	-	4,8			
$V_{Rd,b II}$ ( $c \geq 120$ mm)	HIT-V, HAS-U    M8, M10	$\geq 50$	12	-	3,6		
			$\geq 20$	-	4,8		
	HIT-V, HAS-U    M12, M16	$\geq 50$	$\geq 12$	-	4,8		
			$\geq 12$	-	4,8		
	HIT-V + HIT-SC    M8, M10, M12, M16 HAS-U + HIT-SC    M8, M10, M12, M16 HIT-IC                M8, M10, M12 HIT-IC + HIT-SC    M8, M10, M12	$\geq 80$	$\geq 12$	-	4,8		
$\geq 12$			-	4,8			
<b>HCS1 - Hollow silica brick</b> <b>KSL, 8DF (ETA data)</b>							
$N_{Rd,p} = N_{Rd,b}$ ( $c \geq 50$ mm)	HIT-V + HIT-SC    M8, M10, M12, M16 HAS-U + HIT-SC    M8, M10, M12, M16 HIT-IC + HIT-SC    M8, M10, M12	$\geq 80$	12	-	-	1,6	1,2
			20	-	-	2,2	1,8
	HIT-V + HIT-SC    M8, M10, M12, M16 HAS-U + HIT-SC    M8, M10, M12, M16	$\geq 130$	12	-	-	2,0	1,6
			20	-	-	3,0	2,4
$V_{Rd,b II}$ ( $c \geq 125$ mm)	HIT-V + HIT-SC    M8 HAS-U + HIT-SC    M8	$\geq 80$	12	-	2,4		
			20	-	3,6		
	HIT-V + HIT-SC    M10 HAS-U + HIT-SC    M10		12	-	3,6		
			20	-	4,8		
	HIT-V + HIT-SC    M12, M16 HAS-U + HIT-SC    M12, M16 HIT-IC + HIT-SC    M10, M12		12	-	4,8		
			20	-	4,8		
<b>HCS2 - Hollow silica brick</b> <b>Germany KSL, 3DF (Hilti data)</b>							
$N_{Rd,p} = N_{Rd,b}$ ( $c \geq 50$ mm)	HIT-V + HIT-SC    M8, M10, M12, M16 HAS-U + HIT-SC    M8, M10, M12, M16 HIT-IC + HIT-SC    M8, M10, M12	$\geq 80$	12	-	-	2,0	1,6
$V_{Rd,b}$ ( $c \geq 120$ mm)	HIT-V + HIT-SC    M8, M10, M12, M16 HAS-U + HIT-SC    M8, M10, M12, M16 HIT-IC + HIT-SC    M8, M10, M12	$\geq 80$	12	-	-	2,0	

a) Compressed Air Cleaning only

**Design tension and shear resistances – Pull-out failure of the anchor, brick breakout failure and local brick failure at edge distance ( $c \geq c^*$ ) for single anchor applications**



Load type	Anchor size	$h_{ef}$ [mm]	$f_b$ [N/mm <sup>2</sup> ]	w/w and w/d		d/d	
				Ta	Tb	Ta	Tb
Loads [kN]							
<b>SLWC1 - Solid lightweight concrete brick</b> <b>Vbl, 2DF (ETA data)</b>							
$N_{Rd,p} = N_{Rd,b}$ ( $c \geq 115$ mm)	HIT-V, HAS-U M8, M10, M12, M16	$\geq 50$	4	1,2	0,8	1,2 (1,4 <sup>a</sup> )	1,0
			6	1,4	1,2	1,6	1,2 (1,4 <sup>a</sup> )
	HIT-V, HAS-U M8, M10, M12, M16	$\geq 80$	4	1,8	1,4	2,0	1,6 (1,8 <sup>a</sup> )
			6	2,2	1,8	2,4 (2,6 <sup>a</sup> )	2,0 (2,2 <sup>a</sup> )
	HAS-U + HIT-SC M8, M10, M12, M16	$\geq 100$	4	2,4	2,0	2,6 (2,8 <sup>a</sup> )	2,2 (2,4 <sup>a</sup> )
			6	3,0	2,4	3,2 (3,4 <sup>a</sup> )	2,6 (2,8 <sup>a</sup> )
$V_{Rd,b II}$ ( $c \geq 115$ mm)	HIT-V, HAS-U M8, M10, M12, M16	$\geq 50$	4	0,8			
			6	1,0			
	HIT-V, HAS-U M10, M12, M16	$\geq 80$	4	1,0			
			6	1,2			
	HIT-V + HIT-SC M8, M10, M12, M16	$\geq 80$	4	1,0			
			6	1,2			
HIT-IC M8, M10, M12	$\geq 80$	4	1,0				
		6	1,2				
HIT-IC + HIT-SC M8, M10, M12	$\geq 80$	4	1,0				
		6	1,2				
<b>SLWC2 - Solid lightweight concrete brick</b> <b>Sweden Leca typ 3 (Hilti data)</b>							
$N_{Rd,p} = N_{Rd,b}$ ( $c \geq 115$ mm)	HIT-V + HIT-SC M8, M10, M12, M16	$\geq 80$	3	2,2	1,8	2,4 (2,6 <sup>a</sup> )	2,0 (2,2 <sup>a</sup> )
	HAS-U + HIT-SC M8, M10, M12, M16						
	HIT-IC + HIT-SC M8, M10, M12						
$V_{Rd,b}$ ( $c \geq 115$ mm)	HIT-V + HIT-SC M8, M10, M12, M16	$\geq 80$	3	1,6			
	HAS-U + HIT-SC M8, M10, M12, M16			1,6			
	HIT-IC + HIT-SC M8, M10, M12			1,0			
<b>SLWC3 - Solid lightweight concrete brick</b> <b>Italy "Tufo" volcanic rock (Hilti data)</b>							
$N_{Rd,p} = N_{Rd,b}$ ( $c \geq 115$ mm)	HIT-V, HAS-U M8	$\geq 80$	4	1,2	1,0	1,4	1,2
	HIT-V, HAS-U M10			1,6	1,2	1,8	1,4 (1,6 <sup>a</sup> )
	HIT-V, HAS-U M12			1,8	1,6	2,0	1,8
	HIT-V, HAS-U M16			2,2	1,8	2,4 (2,6 <sup>a</sup> )	2,0 (2,2 <sup>a</sup> )
$V_{Rd,b}$ ( $c \geq 115$ mm)	HIT-V, HAS-U M8	$\geq 80$	4	0,8			
	HIT-V, HAS-U M10, M12, M16			1,8			
<b>HLWC1 - Hollow lightweight concrete brick</b> <b>Hbl, 16DF (ETA data)</b>							
$N_{Rd,p} = N_{Rd,b}$ ( $c \geq 125$ mm)	HIT-V + HIT-SC M8, M10	$\geq 80$	2	1,4	1,2	1,6	1,2 (1,4 <sup>a</sup> )
	HAS-U + HIT-SC M8, M10			2,4	2,0	2,6 (2,8 <sup>a</sup> )	2,2 (2,4 <sup>a</sup> )
	HIT-IC + HIT-SC M8			2,4	2,0	2,6 (2,8 <sup>a</sup> )	2,2 (2,4 <sup>a</sup> )
	HIT-V + HIT-SC M12, M16	$\geq 80$	2	1,6	1,4	1,8	1,4 (1,6 <sup>a</sup> )
	HAS-U + HIT-SC M12, M16			2,8	2,4	3,2	2,6 (2,8 <sup>a</sup> )
	HIT-IC + HIT-SC M10, M12			2,8	2,4	3,2	2,6 (2,8 <sup>a</sup> )
$V_{Rd,b}$ ( $c \geq 250$ mm)	HIT-V + HIT-SC M8, M10	$\geq 80$	2	1,6			
	HAS-U + HIT-SC M8, M10			2,6			
	HIT-IC + HIT-SC M8			2,2			
	HIT-V + HIT-SC M12			2,2			
	HAS-U + HIT-SC M12			3,8			
	HIT-IC + HIT-SC M10			2,4			
HIT-V + HIT-SC M16	$\geq 80$	2	2,4				
HAS-U + HIT-SC M16			4,0				
HIT-IC + HIT-SC M12			4,0				

Load type	Anchor size	$h_{ef}$ [mm]	$f_b$ [N/mm <sup>2</sup> ]	w/w and w/d		d/d		
				Ta	Tb	Ta	Tb	
Loads [kN]								
	<b>HLWC2 - Hollow lightweight concrete brick Germany - Hbl 2, 10DF (Hilti data)</b>							
$N_{Rd,p} = N_{Rd,b}$ (c ≥ 50 mm)	HIT-V + HIT-SC	M8, M10, M12, M16	≥ 80	2	0,6	0,5	0,6	0,5 (0,6 <sup>a</sup> )
	HAS-U + HIT-SC	M8, M10, M12, M16						
	HIT-IC + HIT-SC	M8, M10, M12						
$V_{Rd,b}$ (c ≥ 250 mm)	HIT-V + HIT-SC	M8, M10, M12, M16	≥ 80	2	0,6			
	HAS-U + HIT-SC	M8, M10, M12, M16						
	HIT-IC + HIT-SC	M8, M10, M12						

a) Compressed Air Cleaning only





**Design tension and shear resistances – Pull-out failure of the anchor, brick breakout failure and local brick failure at edge distance (c ≥ c\*) for single anchor applications**

Load type	Anchor size	$h_{ef}$ [mm]	$f_b$ [N/mm <sup>2</sup> ]	w/w and w/d		d/d		
				Ta	Tb	Ta	Tb	
Loads [kN]								
	<b>HLWC3 - Hollow lightweight concrete brick Germany - Hbl 4, 8DF (Hilti data)</b>							
$N_{Rd,p} = N_{Rd,b}$ (c ≥ 50 mm)	HIT-V + HIT-SC	M8, M10, M12, M16	≥ 80	4	0,6	0,6	0,8	0,6
	HAS-U + HIT-SC	M8, M10, M12, M16						
	HIT-IC + HIT-SC	M8, M10, M12						
$V_{Rd,b}$ (c ≥ 250 mm)	HIT-V + HIT-SC	M8, M10, M12, M16	≥ 80	4	1,4			
	HAS-U + HIT-SC	M8, M10, M12, M16						
	HIT-IC + HIT-SC	M8, M10, M12						
	<b>SNWC1 - Solid normal weight concrete brick Vbn, 2DF (ETA data)</b>							
$N_{Rd,p} = N_{Rd,b}$ (c ≥ 115 mm)	HIT-V, HAS-U	M8, M10, M12, M16	≥ 80 <sup>b)</sup>	6	1,2	1,0	1,2	1,0
	HIT-V + HIT-SC	M8, M10, M12, M16						
	HAS-U + HIT-SC	M8, M10, M12, M16						
	HIT-IC	M8, M10, M12						
	HIT-IC + HIT-SC	M8, M10, M12						
$V_{Rd,b}$ (c ≥ 115 mm)	HIT-V, HAS-U	M8, M10, M12, M16	≥ 80 <sup>b)</sup>	6	1,6			
	HIT-V + HIT-SC	M8, M10, M12, M16						
	HAS-U + HIT-SC	M8, M10, M12, M16						
	HIT-IC	M8, M10, M12						
	HIT-IC + HIT-SC	M8, M10, M12						
	<b>SNWC2 - Solid normal weight concrete brick UK Dense concrete b=100 mm (Hilti data)</b>							
$N_{Rd,p} = N_{Rd,b}$ (c ≥ 115 mm)	HIT-V, HAS-U	M8, M10, M12, M16	50	14	2,2	1,8	2,2	1,8
	HIT-V + HIT-SC	M8, M10, M12, M16						
	HAS-U + HIT-SC	M8, M10, M12, M16						
$V_{Rd,b}$ (c ≥ 115 mm)	HIT-V, HAS-U	M8, M10, M12, M16	50	14	4,2			
	HIT-V + HIT-SC	M8, M10, M12, M16						
	HAS-U + HIT-SC	M8, M10, M12, M16						

Load type	Anchor size	$h_{ef}$ [mm]	$f_b$ [N/mm <sup>2</sup> ]	w/w and w/d		d/d		
				Ta	Tb	Ta	Tb	
Loads [kN]								
 <b>SNWC3 - Solid normal weight concrete brick</b> <b>UK Dense concrete b=140 mm (Hilti data)</b>								
$N_{Rd,p} = N_{Rd,b}$ (c ≥ 115 mm)	HIT-V, HAS-U	M8, M10, M12, M16	≥ 50	14	2,2	1,8	2,2	1,8
	HIT-V + HIT-SC	M8, M10, M12, M16						
	HAS-U + HIT-SC	M8, M10, M12, M16						
	HIT-IC	M8, M10, M12						
	HIT-IC + HIT-SC	M8, M10, M12						
$V_{Rd,b}$ (c ≥ 115 mm)	HIT-V, HAS-U	M8, M10, M12, M16	50	14	4,2			
	HIT-V + HIT-SC	M8, M10, M12, M16						
	HAS-U + HIT-SC	M8, M10, M12, M16						
	HIT-V, HAS-U	M8, M10	80		4,2			
	HIT-V + HIT-SC	M8, M10						
	HAS-U + HIT-SC	M8, M10						
	HIT-V, HAS-U	M12, M16			4,8			
	HIT-V + HIT-SC	M12, M16						
	HAS-U + HIT-SC	M12, M16						
HIT-IC	M8, M10, M12							
HIT-IC + HIT-SC	M8, M10, M12							
 <b>HNWC1 - Hollow normal weight concrete brick</b> <b>Parpaing creux (ETA data)</b>								
$N_{Rd,p} = N_{Rd,b}$ (c ≥ 50 mm)	HIT-V + HIT-SC	M8, M10, M12, M16	≥ 50	4	0,36	0,36	0,36	0,36
	HAS-U + HIT-SC	M8, M10, M12, M16		10	0,8	0,6	0,8	0,6
	HIT-IC + HIT-SC	M8, M10, M12	≥ 130	4	0,6	0,5	0,6	0,5
	HIT-V + HIT-SC	M8, M10, M12, M16		10	1,0	0,8	1,0	0,8
	HAS-U + HIT-SC	M8, M10, M12, M16		4	1,6			
	HAS-U + HIT-SC	M8, M10, M12, M16		10	2,6			
$V_{Rd,b}$ (c ≥ 200 mm)	HIT-V + HIT-SC	M8, M10, M12, M16	≥ 50	4	1,6			
	HAS-U + HIT-SC	M8, M10, M12, M16		10	2,6			
	HIT-V + HIT-SC	M8, M10, M12, M16	≥ 80	4	2,0			
	HAS-U + HIT-SC	M8, M10, M12, M16		10	3,0			

- a) Compressed Air Cleaning only  
 b) ≥ 50 mm for HIT-V without HIT-SC

**Design tension and shear resistances – Pull-out failure of the anchor, brick breakout failure and local brick failure at edge distance ( $c \geq c^*$ ) for single anchor applications**

Load type	Anchor size	$h_{ef}$ [mm]	$f_b$ [N/mm <sup>2</sup> ]	w/w and w/d		d/d		
				Ta	Tb	Ta	Tb	
				Loads [kN]				
 <b>HNWC2 - Hollow normal weight concrete brick Italy Blocchi Cem (Hilti data)</b>								
$N_{Rd,p} = N_{Rd,b}$ ( $c \geq 50$ mm)	HIT-V + HIT-SC	M8, M10, M12, M16	$\geq 50$	8	1,0	0,8	1,0	0,8
	HAS-U + HIT-SC	M8, M10, M12, M16						
	HIT-IC + HIT-SC	M8, M10, M12						
$V_{Rd,b}$ ( $c \geq 200$ mm)	HIT-V + HIT-SC	M8, M10	$\geq 50$	8	4,0			
	HAS-U + HIT-SC	M8, M10						
	HIT-IC + HIT-SC	M8						
	HIT-V + HIT-SC	M12, M16			4,4			
	HAS-U + HIT-SC	M12, M16						
	HIT-IC + HIT-SC	M10, M12						
 <b>HNWC3 - Hollow normal weight concrete brick Germany Hbn 4, 12DF (Hilti data)</b>								
$N_{Rd,p} = N_{Rd,b}$ ( $c \geq 50$ mm)	HIT-V + HIT-SC	M8, M10, M12, M16	$\geq 80$	4	0,6	0,5	0,6	0,5
	HAS-U + HIT-SC	M8, M10, M12, M16		10	1,0	0,8	1,0	0,8
	HIT-IC + HIT-SC	M8, M10, M12						
$V_{Rd,b}$ ( $c \geq 240$ mm)	HIT-V + HIT-SC	M8, M10, M12, M16	$\geq 80$	4	2,2			
	HAS-U + HIT-SC	M8, M10, M12, M16		10	3,6			
	HIT-IC + HIT-SC	M8, M10, M12						
 <b>HNWC4 - Hollow normal weight concrete brick UK (b=215 mm) (Hilti data)</b>								
$N_{Rd,p} = N_{Rd,b}$ ( $c \geq 50$ mm)	HIT-V + HIT-SC	M8	80	10	0,4	0,4	0,4	0,4
	HAS-U + HIT-SC	M8						
	HIT-V + HIT-SC	M10, M12, M16			1,0	0,8	1,0	0,8
	HAS-U + HIT-SC	M10, M12, M16						
$V_{Rd,b}$ ( $c \geq 220$ mm)	HIT-V + HIT-SC	M8	80	10	1,4			
	HAS-U + HIT-SC	M8						
	HIT-V + HIT-SC	M10			2,0			
	HAS-U + HIT-SC	M10						
	HIT-V + HIT-SC	M12, M16			2,8			
	HAS-U + HIT-SC	M12, M16						
 <b>HNWC5 - Hollow normal weight concrete brick UK (b=138 mm) (Hilti data)</b>								
$N_{Rd,p} = N_{Rd,b}$ ( $c \geq 50$ mm)	HIT-V + HIT-SC	M8	80	13	0,6	0,6	0,6	0,6
	HAS-U + HIT-SC	M8						
	HIT-V + HIT-SC	M10, M12, M16			1,0	0,8	1,0	0,8
	HAS-U + HIT-SC	M10, M12, M16						
$V_{Rd,b}$ ( $c \geq 220$ mm)	HIT-V + HIT-SC	M8	80	13	1,4			
	HAS-U + HIT-SC	M8						
	HIT-V + HIT-SC	M10			2,0			
	HAS-U + HIT-SC	M10						
	HIT-V + HIT-SC	M12, M16			2,8			
	HAS-U + HIT-SC	M12, M16						
 <b>HNWC6 - Hollow normal weight concrete brick UK (b=112 mm) (Hilti data)</b>								
$N_{Rd,p} = N_{Rd,b}$ ( $c \geq 50$ mm)	HIT-V + HIT-SC	M8	50	7	0,6	0,6	0,6	0,6
	HAS-U + HIT-SC	M8						
	HIT-V + HIT-SC	M10, M12, M16			1,0	0,8	1,0	0,8
	HAS-U + HIT-SC	M10, M12, M16						
$V_{Rd,b}$ ( $c \geq 100$ mm)	HIT-V + HIT-SC	M8	50	7	1,4			
	HAS-U + HIT-SC	M8						
	HIT-V + HIT-SC	M10			2,0			
	HAS-U + HIT-SC	M10						
	HIT-V + HIT-SC	M12, M16			2,8			
	HAS-U + HIT-SC	M12, M16						

Masonry



Chemical anchors

Mechanical anchors

Plastic/Light duty metal anchors

Insulation anchors



Load type	Anchor size	$h_{ef}$ [mm]	$f_b$ [N/mm <sup>2</sup> ]	w/w and w/d		d/d	
				Ta	Tb	Ta	Tb
Loads [kN]							
 <b>HNWC7 - Hollow normal weight concrete brick</b> Finland "Standard Concrete Brick" (Hilti data)							
$N_{Rd,p} = N_{Rd,b}$ (c ≥ 50 mm)	HIT-V + HIT-SC M8, M10	50	6	0,6	0,4	0,6	0,4
	HAS-U + HIT-SC M8, M10						
	HIT-V + HIT-SC M12, M16	50	6	0,8	0,6	0,8	0,6
	HAS-U + HIT-SC M12, M16						
$V_{Rd,b}$ (c ≥ 100 mm)	HIT-V + HIT-SC M8	50	6	1,0			
	HAS-U + HIT-SC M8			1,0			
	HIT-V + HIT-SC M10			1,4			
	HAS-U + HIT-SC M10			1,4			
	HIT-V + HIT-SC M12, M16	50	6	1,6			
	HAS-U + HIT-SC M12, M16			1,6			
 <b>HNWC8 - Hollow normal weight concrete brick</b> AUS Block system 200 (Hilti data)							
$N_{Rd,p} = N_{Rd,b}$ (c ≥ 50 mm)	HIT-V + HIT-SC M8, M10, M12, M16	≥ 50	15	1,0	0,8	1,0	0,8
	HAS-U + HIT-SC M8, M10, M12, M16						
	HIT-IC + HIT-SC M8, M10, M12						
$V_{Rd,b}$ (c ≥ 200 mm)	HIT-V + HIT-SC M8, M10	≥ 50	15	2,0			
	HAS-U + HIT-SC M8, M10			2,0			
	HIT-V + HIT-SC M12, M16			3,2			
	HAS-U + HIT-SC M12, M16			3,2			
	HIT-IC + HIT-SC M8, M10, M12						

a) Compressed Air Cleaning only

**Design tension and shear resistance – Pull out / Pushing out of one brick failure modes**
**Pull out of one brick (tension):**

$$N_{Rd,pb} = 2 \cdot l \cdot b \cdot (0,5 \cdot f_{vko} + 0,4 \cdot \sigma_d) / (2,5 \cdot 1000) \quad [\text{kN}]$$

$$N_{Rd,pb} = (2 \cdot l \cdot b \cdot (0,5 \cdot f_{vko} + 0,4 \cdot \sigma_d) + b \cdot h \cdot f_{vko}) / (2,5 \cdot 1000) \quad [\text{kN}]$$

\* this equation is applicable if the vertical joints are filled

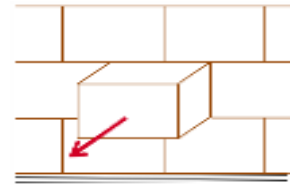
**Pushing out of one brick (shear):**

$$V_{Rd,pb} = 2 \cdot l \cdot b \cdot (0,5 \cdot f_{vko} + 0,4 \cdot \sigma_d) / (2,5 \cdot 1000) \quad [\text{kN}]$$

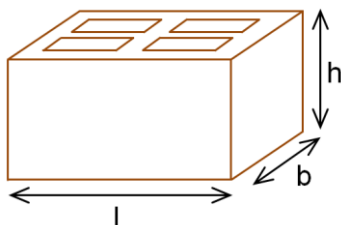
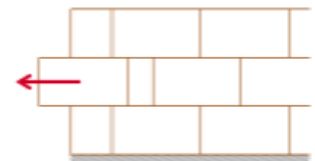
 $\sigma_d$  = design compressive stress perpendicular to the shear (N/mm<sup>2</sup>)  
 $f_{vko}$  = initial shear strength according to EN 1996-1-1, Table 3.4

Brick type	Mortar strength	$f_{vko}$ [N/mm <sup>2</sup> ]
Clay brick	M2,5 to M9	0,20
	M10 to M20	0,30
All other types	M2,5 to M9	0,15
	M10 to M20	0,20

## On-site tests



For other bricks in solid or hollow masonry, not covered by the Hilti HIT-HY 270 ETA or this technical data manual, the characteristic resistance may be determined by on-site tension tests (pull-out tests or proof-load tests), according to EOTA TR053.

For the evaluation of test results, the characteristic resistance may be obtained taking into account the  $\beta$  factor, which considers the different influences of the product.

The  $\beta$  factor for the brick types covered by the Hilti HIT-HY 270 ETA is provided on the following table:

Use categories		w/w and w/d		d/d	
Temperature range		Ta*	Tb*	Ta*	Tb*
Base material	Cleaning				
Solid clay brick EN 771-1	CAC	0,96	0,96	0,96	0,96
	MC	0,84	0,84	0,84	0,84
Solid calcium silicate brick EN 771-2	CAC/MC	-	-	0,96	0,80
Solid light weight concrete brick EN 771-3	CAC	0,82	0,68	0,96	0,80
	MC	0,81	0,67	0,90	0,75
Solid normal weight concrete brick EN 771-3	CAC/MC	0,96	0,80	0,96	0,80
Hollow clay brick EN 771-1	CAC	0,96	0,96	0,96	0,96
	MC	0,84	0,84	0,84	0,84
Hollow calcium silicate brick EN 771-2	CAC/MC	-	-	0,96	0,80
Hollow light weight concrete brick EN 771-3	CAC	0,69	0,57	0,81	0,67
	MC	0,68	0,56	0,76	0,63
Hollow normal weight concrete brick EN 771-3	CAC/MC	0,96	0,80	0,96	0,80

\*Ta / Tb, w/w and d/d anchorage parameters, as defined on Table page 9

Applying the  $\beta$  factor from the table above, the characteristic tension resistance  $N_{Rk}$  can be obtained. Characteristic shear resistance  $V_{Rk}$  can also be directly derived from  $N_{Rk}$ . For detailed procedure consult EOTA TR053.

## Materials

### Material quality

Part	Material
Threaded rod HIT-V 5.8 (F) HAS-U 5.8 (F)	Strength class 5.8, A5 > 8% ductile Electroplated zinc coated $\geq 5 \mu\text{m}$ ; (F) Hot dip galvanized $\geq 45 \mu\text{m}$
Threaded rod HIT-V 8.8 (F) HAS-U 8.8 (F)	Strength class 8.8, A5 > 8% ductile Electroplated zinc coated $\geq 5 \mu\text{m}$ ; (F) Hot dip galvanized $\geq 45 \mu\text{m}$
Threaded rod HIT-V-R HAS-U-R	Stainless steel grade A4 A5 > 8% ductile strength class 70, 1.4401; 1.4404; 1.4578; 1.4571; 1.4439; 1.4362
Threaded rod HIT-V-HCR HAS-U-HCR	High corrosion resistant steel, A5 > 8% ductile 1.4529, 1.4565
Washer	Electroplated zinc coated, hot dip galvanized
	Stainless steel 1.4401; 1.4404; 1.4578; 1.4571; 1.4439; 1.4362
	High corrosion resistant steel 1.4529, 1.4565 EN 10088
Nut	Strength class 8 steel galvanized $\geq 5 \mu\text{m}$ , ; hot dipped galvanized $\geq 45 \mu\text{m}$
	Strength class 70, stainless steel grade A4, 1.4401; 1.4404; 1.4578; 1.4571; 1.4439; 1.4362
	Strength class 70, high corrosion resistant steel, 1.4529; 1.4565
Internally threaded sleeve HIT-IC	A5 > 8% ductile ; Electroplated zinc coated $\geq 5 \mu\text{m}$
Sieve sleeve HIT-SC	Frame: Polyfort FPP 20T ; Sieve: PA6.6 N500/200

### Base materials:

- Solid brick masonry. The resistances are also valid for larger brick sizes and larger compressive strengths of the masonry unit.
- Hollow brick masonry
- Mortar strength class of the masonry: M2,5 at minimum according to EN 998-2: 2010.
- For other bricks in solid masonry and in hollow or perforated masonry, the characteristic resistance of the anchor may be determined by on-site tests according to EOTA TR053 under consideration of the  $\beta$ -factor according to the table on page 21.

## Installation parameters

### Applications for hollow and solid bricks with sieve sleeves

For installing HIT-V, HAS-U and HIT-IC with embedments of 50 and 80 mm, a single sieve sleeve is used.

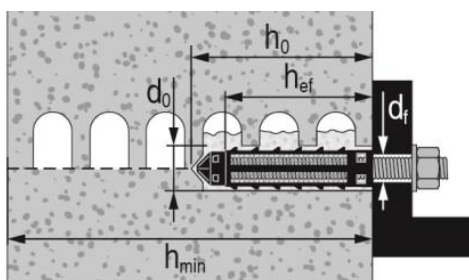

Hollow brick with threaded rod HIT-V, HAS-U or internally threaded sleeve HIT-IC and a single sieve sleeve HIT-SC

### Installation parameters of HIT-V / HAS-U with one sieve sleeve HIT-SC in hollow and solid brick

HIT-V / HAS-U		M6	M8		M10		M12		M16	
with HIT-SC		12x85	16x50	16x85	16x50	16x85	18x50	18x85	22x50	22x85
Nominal diameter of drill bit	$d_0$ [mm]	12	16	16	16	16	18	18	22	22
Drill hole depth	$h_0$ [mm]	95	60	95	60	95	60	95	60	95
Effective embedment depth	$h_{ef}$ [mm]	80	50	80	50	80	50	80	50	80
Maximum diameter of clearance hole in the fixture	$d_f$ [mm]	7	9	9	12	12	14	14	18	18
Minimum wall thickness	$h_{min}$ [mm]	115	80	115	80	115	80	115	80	115
Brush HIT-RB	- [-]	12	16	16	16	16	18	18	22	22
Number of strokes HDM	- [-]	5	4	6	4	6	4	8	6	10
Nr. of strokes HDE 500-A	- [-]	4	3	5	3	5	3	6	5	8
Max. torque moment for all brick types except "parpaing creux"	$T_{max}$ [Nm]	0	3	3	4	4	6	6	8	8
Maximum torque moment for "parpaing creux"	$T_{max}$ [Nm]	-	2	2	2	2	3	3	6	6

### Installation parameters of HIT-IC with HIT-SC in hollow and solid brick

HIT-IC		M8	M10	M12
with HIT-SC		16x85	18x85	22x85
Nominal diameter of drill bit	$d_0$ [mm]	16	18	22
Drill hole depth	$h_0$ [mm]	95	95	95
Effective embedment depth	$h_{ef}$ [mm]	80	80	80
Thread engagement length	$h_s$ [mm]	8...75	10...75	12...75
Maximum diameter of clearance hole in the fixture	$d_f$ [mm]	9	12	14
Minimum wall thickness	$h_{min}$ [mm]	115	115	115
Brush HIT-RB	- [-]	16	18	22
Number of strokes HDM	- [-]	6	8	10
Number of strokes HDE-500	- [-]	5	6	8
Maximum torque moment	$T_{max}$ [Nm]	3	4	6

### Applications for hollow and solid bricks with sieve sleeves (cont.)

For installing HIT-V, HAS-U and HIT-IC with embedments of 130 and 160 mm, two attached sleeves HIT-SC are used.

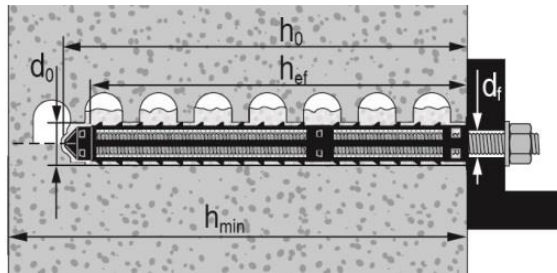

Hollow brick with threaded rod HIT-V / HAS-U and two sieve sleeves HIT-SC for deeper embedment depth

#### Installation parameters of HIT-V / HAS-U with two attached sleeves HIT-SC in hollow and solid brick

HIT-V / HAS-U		M8		M10		M12		M16	
<b>with HIT-SC</b>		16x50 + 16x85	16x85 + 16x85	16x50 + 16x85	16x85 + 16x85	18x50 + 18x85	18x85 + 18x85	22x50 + 22x85	22x85 + 22x85
Nominal diameter of drill bit	$d_0$ [mm]	16	16	16	16	18	18	22	22
Drill hole depth	$h_0$ [mm]	145	180	145	180	145	180	145	180
Effective embedment depth	$h_{ef}$ [mm]	130	160	130	160	130	160	130	160
Maximum diameter of clearance hole in the fixture	$d_{fr}$ [mm]	9	9	12	12	14	14	18	18
Minimum wall thickness	$h_{min}$ [mm]	195	230	195	230	195	230	195	230
Brush HIT-RB	- [-]	16	16	16	16	18	18	22	22
Number of strokes HDM	- [-]	4+6	6+6	4+6	6+6	4+8	8+8	6+10	10+10
Number of strokes HDE-500	- [-]	3+5	5+5	3+5	5+5	3+6	6+6	5+8	8+8
Maximum torque moment	$T_{max}$ [Nm]	3	3	4	4	6	6	8	8

### Applications for hollow and solid bricks with sieve sleeves (cont.)

For through fastenings with HIT-V and HAS-U, two attached sleeves are used.

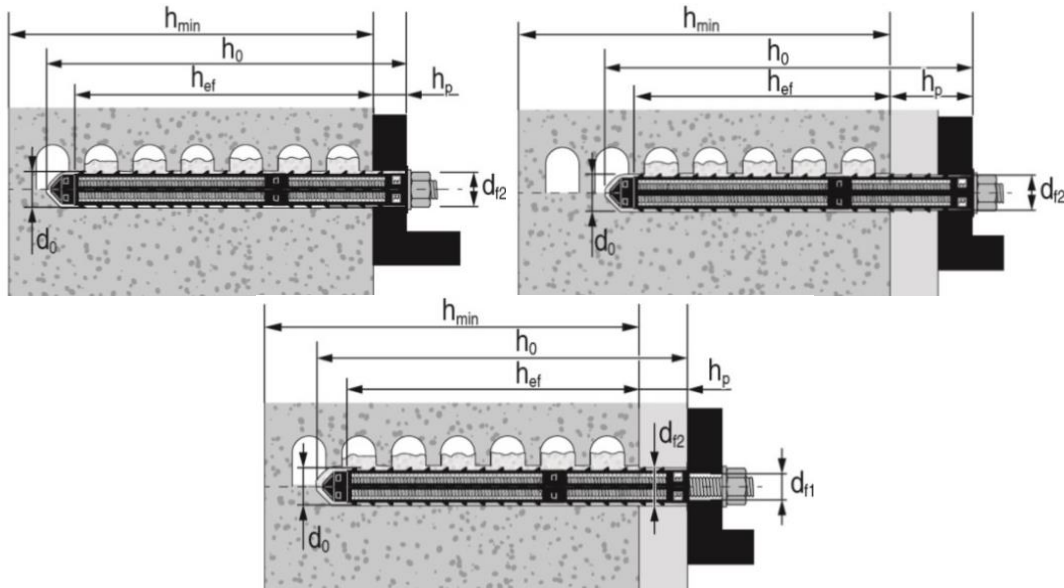

Hollow and solid brick with threaded rod HIT-V and HAS-U with two sieve sleeves HIT-SC for setting through the fixture and/or through the non-loadbearing layer

### Installation parameters of HIT-V / HAS-U with two sieve sleeves through the fixture and/or through the non-loadbearing layer in hollow and solid bricks

HIT-V / HAS-U		M8		M10		M12		M16	
<b>with HIT-SC</b>		16x50 + 16x85	16x85 + 16x85	16x50 + 16x85	16x85 + 16x85	18x50 + 18x85	18x85 + 18x85	22x50 + 22x85	22x85 + 22x85
Nominal diameter of drill bit	$d_0$ [mm]	16	16	16	16	18	18	22	22
Drill hole depth	$h_0$ [mm]	145	180	145	180	145	180	145	180
Effective embedment depth	$h_{ef, min}$ [mm]	80	80	80	80	80	80	80	80
Max. thickness of non-loadbearing layer and fixture (through setting)	$h_{p, max}$ [mm]	50	80	50	80	50	80	50	80
Max. diameter of clearance hole in the fixture (pre-setting)	$d_{r1}$ [mm]	9	9	12	12	14	14	18	18
Max. diameter of clearance hole in fixture (through setting)	$d_{r2}$ [mm]	17	17	17	17	19	19	23	23
Minimum wall thickness	$h_{min}$ [mm]	$h_{ef}+65$	$h_{ef}+70$	$h_{ef}+65$	$h_{ef}+70$	$h_{ef}+65$	$h_{ef}+70$	$h_{ef}+65$	$h_{ef}+70$
Brush HIT-RB	- [-]	16	16	16	16	18	18	22	22
Number of strokes HDM	- [-]	4+6	6+6	4+6	6+6	4+8	8+8	6+10	10+10
Number of strokes HDE	- [-]	3+5	5+5	3+5	5+5	5+8	8+8	5+8	8+8
Max. torque moment for all brick types except "parpaing creux"	$T_{max}$ [Nm]	3	3	4	4	6	6	8	8
Max. torque moment for "parpaing creux"	$T_{max}$ [Nm]	2	2	2	2	3	3	6	6

### Applications for solid bricks without sieve sleeves.

Hilti recommends the anchoring in masonry always with sieve sleeve. Anchors can only be installed without sieve sleeves in solid bricks when it is guaranteed that it has not any hole or void.

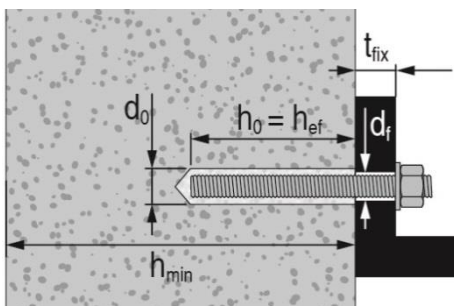

Solid brick with threaded rod HIT-V or HAS-U

### Installation parameters of HIT-V / HAS-U in solid bricks

Threaded rods and HIT-V / HAS-U		M8	M10	M12	M16
Nominal diameter of drill bit	$d_0$ [mm]	10	12	14	18
Drill hole depth = Effective embedment depth	$h_0 = h_{ef}$ [mm]	50...300	50...300	50...300	50...300
Maximum diameter of clearance hole in the fixture	$d_f$ [mm]	9	12	14	18
Minimum wall thickness	$h_{min}$ [mm]	$h_0+30$	$h_0+30$	$h_0+30$	$h_0+36$
Brush HIT-RB	- [-]	10	12	14	18
Maximum torque moment	$T_{max}$ [Nm]	5	8	10	10

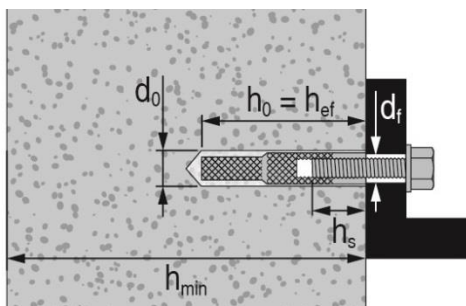

Solid brick with internal threaded sleeve HIT-IC

### Installation parameters of HIT-IC in solid bricks

HIT-IC		M8x80	M10x80	M12x80
Nominal diameter of drill bit	$d_0$ [mm]	14	16	18
Drill hole depth = Effective embedment depth	$h_0 = h_{ef}$ [mm]	80	80	80
Thread engagement length	$h_s$ [mm]	8...75	10...75	12...75
Maximum diameter of clearance hole in the fixture	$d_f$ [mm]	9	12	14
Minimum wall thickness	$h_{min}$ [mm]	115	115	115
Brush HIT-RB	- [-]	14	16	18
Maximum torque moment	$T_{max}$ [Nm]	5	8	10



### Working time and curing time for solid bricks

Temperature in the base material T	Maximum working time $t_{work}$	Minimum curing time $t_{cure}^{1)}$
5 °C to 9 °C	10 min	2,5 h
10 °C to 19 °C	7 min	1,5 h
20 °C to 29 °C	4 min	30 min
30 °C to 40 °C	1 min	20 min

1) The curing time data are valid for dry base material only. In wet base material, the curing times must be doubled.

### Working time and curing time for hollow bricks

Temperature in the base material T	Maximum working time $t_{work}$	Minimum curing time $t_{cure}^{1)}$
0 °C to 4 °C	10 min	4 h
5 °C to 9 °C	10 min	2,5 h
10 °C to 19 °C	7 min	1,5 h
20 °C to 29 °C	4 min	30 min
30 °C to 40 °C	1 min	20 min

1) The curing time data are valid for dry base material only. In wet base material, the curing times must be doubled.

### Installation equipment

Anchor size	M6	M8	M10	M12	M16
Rotary hammer	TE2(A) – TE30(A)				
Other tools	compressed air gun or blow out pump, set of cleaning brushes, dispenser				

### Drilling and cleaning parameters

HIT-V / HAS-U <sup>a)</sup>	HIT-V / HAS-U + sieve sleeve	HIT-IC <sup>a)</sup>	HIT-IC + sieve sleeve	Hammer drill	Brush HIT-RB
				$d_0$ [mm]	size [mm]
-	-	-	-	8	8
M8	-	-	-	10	10
M10	-	-	-	12	12
M12	-	M8	-	14	14
-	M8	M10	M8	16	16
-	M10	-	-	16	16
M16	M12	M12	M10	18	18
-	M16	-	M12	22	22

a) Installation without the sieve sleeve HIT-SC can be used only in case of solid bricks.

## Setting instructions

\*For detailed information on installation see instruction for use given with the package of the product.



### Safety regulations.

Review the Material Safety Data Sheet (MSDS) before use for proper and safe handling! Wear well-fitting protective goggles and protective gloves when working with Hilti HIT-HY 270.

### Drilling

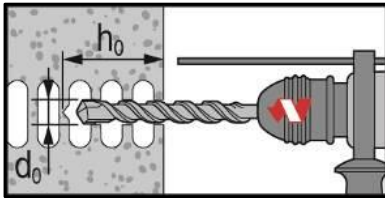

In hollow bricks: rotary mode

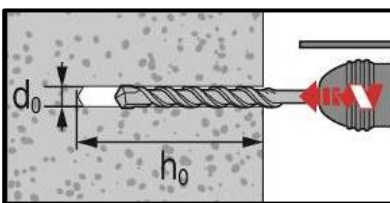

In solid bricks: hammer mode

### Cleaning

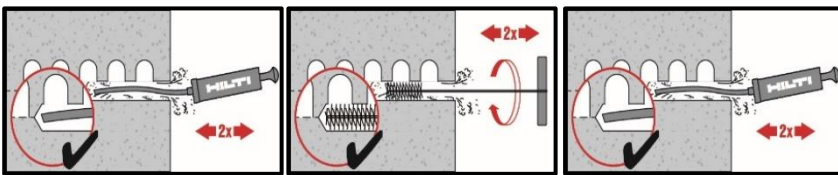

#### Manual cleaning (MC)

For drill hole diameter  $d_0 \leq 18$  mm and drill hole depth  $h_0 \leq 100$  mm

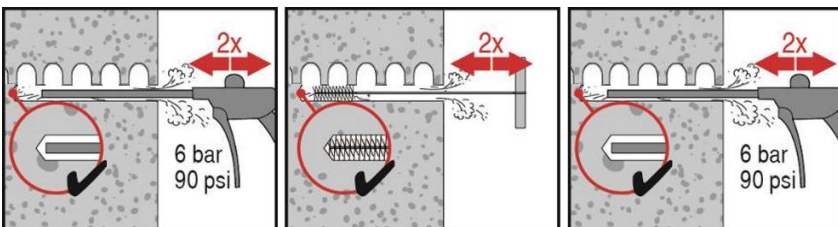

#### Compressed air cleaning (CAC)

For drill hole depth  $h_0 \leq 300$  mm

### Injection preparation for hollow and solid bricks with sieve sleeve

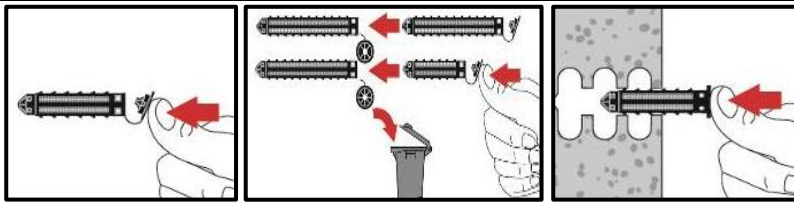

Close lid and insert sieve sleeve manually.

### All applications

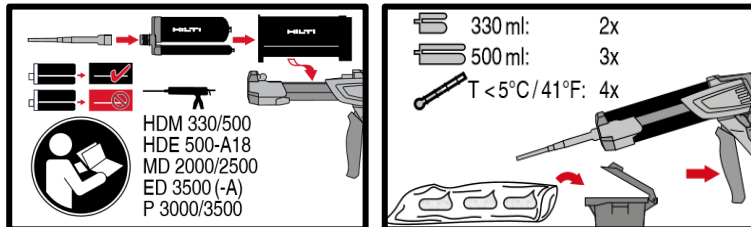

Injection system preparation.

### Inject the adhesive without forming air voids

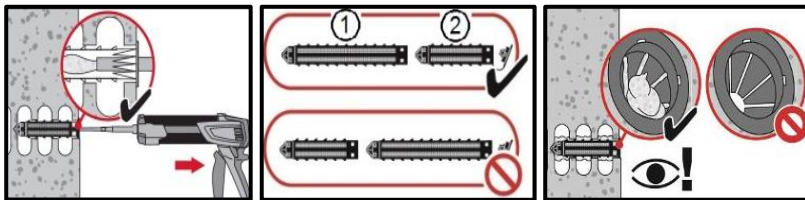

**Injection method 1** for Installation with sieve sleeve HIT-SC. Use extension for installation with two sieve sleeves.

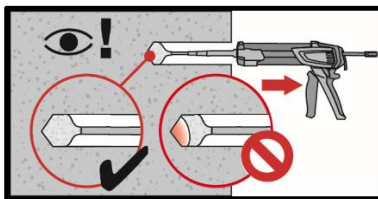

**Injection method 2** for installation in solid bricks without sieve sleeve

### Setting de element

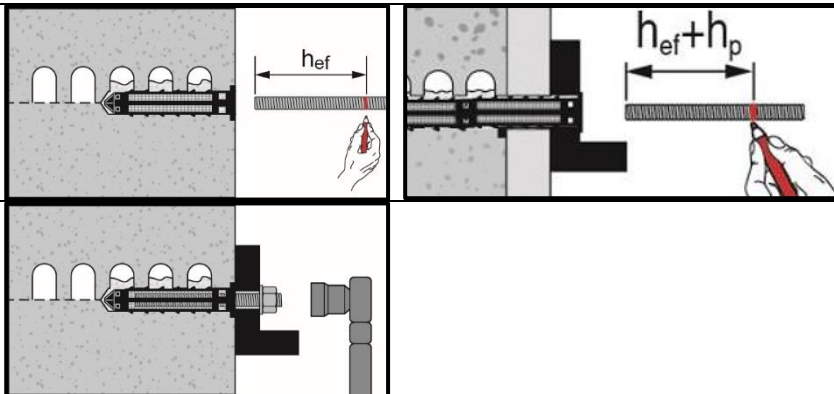

**Marking and setting element**, to the required embedment depth, observing working time  $t_{work}$ .

**Loading the anchor:** After required curing time  $t_{cure}$  the anchor can be loaded. The applied installation torque shall not exceed the values  $T_{max}$ .

# HDA Undercut anchor

Ultimate-performance undercut anchor for dynamic loads

Chemical anchors

Undercut

Mechanical anchors

Plastic/Light duty metal anchors

Insulation anchors

## Anchor version

## Benefits



HDA-P  
HDA-PR  
HDA-PF  
Anchor for pre-setting (M10-M20)

- Safe and high performance structural seismic design with ETA C1 and C2
- Mechanical interlock (undercut)
- Low expansion force (thus small edge distance / spacing)
- Self undercutting (without special undercutting tool)



HDA-T  
HDA-TR  
HDA-TF  
Anchor for through-fastening (M10-M20)

- Performance of a headed stud
- Complete system (anchor, stop drill bit, setting tool, drill hammer)
- Setting mark on anchor for control (easy and safe)
- Completely removable

## Base material

## Load conditions



Concrete (non-cracked)

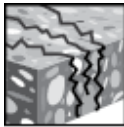

Concrete (cracked)

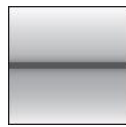

Static/  
quasi-static



Seismic  
ETA-C1, C2

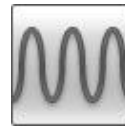

Fatigue



Shock



Fire  
resistance

## Installation conditions

## Other information

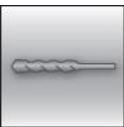

Hammer  
drilled holes

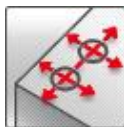

Small edge  
distance  
and spacing



Performance  
of a headed  
stud



European  
Technical  
Assessment



CE  
conformity



PROFIS  
design  
Software



Nuclear power  
plant approval

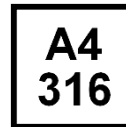

Corrosion  
resistance

## Approvals / certificates

Description	Authority / Laboratory	No. / date of issue
European Technical Assessment <sup>a)</sup>	CSTB, Paris	ETA-99/0009 / 2015-01-06
ICC-ES report incl. seismic <sup>b)</sup>	ICC evaluation service	ESR 1546 / 2014-02-01
Shockproof fastenings in civil defence installations	Federal Office for Civil Protection, Bern	BZS D 09-601/ 2009-10-21
Nuclear power plants	DIBt, Berlin	Z-21.1-1987 / 2014-07-22
Fatigue loading	DIBt, Berlin	Z-21.1-1693 / 2013-07-29
Fire assessment report	Warringtonfire	WF 327804/A 2016-05-3

a) All data for HDA-P(R) and HDA-T(R) given in this section according ETA-99/0009, issue 2015-01-06.

Sherdardized versions HDA-PF and HDA-TF anchors are not covered by the approvals.

b) For more details on Technical Data according to ICC please consult the relevant HNA FTM.

### Static and quasi-static resistance (for a single anchor)

#### All data in this section applies to:

- Correct setting (See setting instruction)
- No edge distance and spacing influence
- Steel failure
- Minimum base material thickness
- Concrete C 20/25,  $f_{ck,cube} = 25 \text{ N/mm}^2$

#### Effective anchorage depth for static

Anchor size	M10	M12	M16	M20
Eff. Anchorage depth $h_{ef}$ [mm]	100	125	190	250

#### Characteristic resistance

Anchor size		M10	M12	M16	M20 <sup>a)</sup>											
<b>Non-cracked concrete</b>																
Tension $N_{Rk}$	HDA-P(F), HDA-T(F) <sup>b)</sup> [kN]	46	67	126	192											
	HDA-PR, HDA-TR	46	67	126	-											
<b>Cracked concrete</b>																
Tension $N_{Rk}$	HDA-P(F), HDA-T(F) <sup>b)</sup> [kN]	25	35	75	95											
	HDA-PR, HDA-TR	25	35	75	-											
<b>Non-cracked and cracked concrete</b>																
Shear $V_{Rk}$	HDA-T(F) <sup>b)</sup>	$t_{fix,min}$ [mm]	10≤	15≤	10≤	15≤	20≤	15≤	20≤	25≤	30≤	35≤	20≤	25≤	40≤	55≤
		$t_{fix,max}$ [mm]	<15	≤20	<15	<20	≤50	<20	<25	<30	<35	≤60	<25	<40	<55	≤100
		$V_{Rk}$ [kN]	65 <sup>c)</sup>	70	80	80	100	140 <sup>c)</sup>	140	155	170	190	205	205	235	250
	HDA-TR	$t_{fix,min}$ [mm]	10≤	15≤	10≤	15≤	20≤	30≤	15≤	20≤	25≤	35≤	-			
		$t_{fix,max}$ [mm]	<15	≤20	<15	<20	<30	≤50	<20	<25	<35	≤60	-			
		$V_{Rk}$ [kN]	71 <sup>c)</sup>	71	87	87	94	109	152	152	158	170	-			
	HDA-P(F) <sup>b)</sup> [kN]		22		30		62		92							
	HDA-PR		23		34		63		-							

- a) HDA M20: only galvanized 5 $\mu$ m version is available.  
b) HDA-PF and HDA-TF: anchors are not covered by ETA-99/0009.  
c) With use of centering washer ( $t=5\text{mm}$ ) only.

#### Design resistance

Anchor size		M10	M12	M16	M20 <sup>a)</sup>											
<b>Non-cracked concrete</b>																
Tension $N_{Rd}$	HDA-P(F), HDA-T(F) <sup>b)</sup> [kN]	30,7	44,7	84,0	128,0											
	HDA-PR, HDA-TR	28,8	41,9	78,8	-											
<b>Cracked concrete</b>																
Tension $N_{Rd}$	HDA-P(F), HDA-T(F) <sup>b)</sup> [kN]	16,7	23,3	50,0	63,3											
	HDA-PR, HDA-TR	16,7	23,3	50,0	-											
<b>Non-cracked and cracked concrete</b>																
Shear $V_{Rd}$	HDA-T(F) <sup>b)</sup>	$t_{fix,min}$ [mm]	10≤	15≤	10≤	15≤	20≤	15≤	20≤	25≤	30≤	35≤	20≤	25≤	40≤	55≤
		$t_{fix,max}$ [mm]	<15	≤20	<15	<20	≤50	<20	<25	<30	<35	≤60	<25	<40	<55	≤100
		$V_{Rk}$ [kN]	43,3 <sup>c)</sup>	46,7	53,3 <sup>c)</sup>	53,3	66,7	93,3 <sup>c)</sup>	93,3	103,3	113,3	126,7	136,7 <sup>c)</sup>	136,7	156,7	166,7
	HDA-TR	$t_{fix,min}$ [mm]	10≤	15≤	10≤	15≤	20≤	30≤	15≤	20≤	25≤	35≤	-			
		$t_{fix,max}$ [mm]	<15	≤20	<15	<20	<30	≤50	<20	<25	<35	≤60	-			
		$V_{Rk}$ [kN]	53,4 <sup>c)</sup>	53,4	65,4 <sup>c)</sup>	65,4	70,7	82,0	114,3 <sup>c)</sup>	114,3	118,8	127,8	-			
	HDA-P(F) <sup>b)</sup> [kN]		17,6		24,0		49,6		73,6							
	HDA-PR		17,3		25,6		47,4		-							

- a) HDA M20: only galvanized 5 $\mu$ m version is available.  
b) HDA-PF and HDA-TF: anchors are not covered by ETA-99/0009.  
c) With use of centering washer ( $t=5\text{mm}$ ) only.

**Recommended loads <sup>d)</sup>**

Anchor size		M10	M12	M16	M20 <sup>a)</sup>											
<b>Non-cracked concrete</b>																
Tension $N_{Rk}$	HDA-P(F), HDA-T(F) <sup>b)</sup> [kN]	21,9	31,9	60,0	91,4											
	HDA-PR, HDA-TR	20,5	29,9	56,3	-											
<b>Cracked concrete</b>																
Tension $N_{Rec}$	HDA-P(F), HDA-T(F) <sup>b)</sup> [kN]	11,9	16,7	35,7	45,2											
	HDA-PR, HDA-TR	11,9	16,7	35,7	-											
<b>Non-cracked and cracked concrete</b>																
Shear $V_{Rec}$	HDA-T(F) <sup>b)</sup>	$t_{fix,min}$ [mm]	10≤	15≤	10≤	15≤	20≤	15≤	20≤	25≤	30≤	35≤	20≤	25≤	40≤	55≤
		$t_{fix,max}$ [mm]	<15	≤20	<15	<20	≤50	<20	<25	<30	<35	≤60	<25	<40	<55	≤100
	$V_{Rk}$ [kN]	31 <sup>c)</sup>	31	38 <sup>c)</sup>	38	38	67 <sup>c)</sup>	67	74	81	90	98 <sup>c)</sup>	98	112	119	
	HDA-TR	$t_{fix,min}$ [mm]	10≤	15≤	10≤	15≤	20≤	30≤	15≤	20≤	25≤	35≤	-			
		$t_{fix,max}$ [mm]	<15	≤20	<15	<20	<30	≤50	<20	<25	<35	≤60	-			
		$V_{Rk}$ [kN]	38 <sup>c)</sup>	38	47 <sup>c)</sup>	47	50	59	82 <sup>c)</sup>	82	85	91	-			
	HDA-P(F) <sup>b)</sup> [kN]		12,6		17,1		35,4		52,6							
	HDA-PR		12,3		18,2		33,8		-							

- a) HDA M20: only galvanized 5µm version is available.  
b) HDA-PF and HDA-TF: anchors are not covered by ETA-99/0009  
c) With use of centering washer (t=5mm) only  
d) With overall partial safety factor for action  $\gamma_F = 1,4$ . The partial safety factors for action depend on the type of loading.

**Seismic resistance**
**All data in this section applies to:**

- Correct setting (See setting instruction with a drilling hammer)
- No edge distance and spacing influence
- *Steel* failure
- Minimum base material thickness
- Concrete C 20/25,  $f_{ck,cube} = 25 \text{ N/mm}^2$
- $\alpha_{gap} = 1,0$  (using Hilti seismic filling set)

**Effective anchorage depth for seismic C2 and C1**

Anchor size	M10	M12	M16	M20
Eff. Anchorage depth $h_{ef}$ [mm]	100	125	190	250

**Characteristic resistance in case of seismic performance category C2**

Anchor size		M10	M12	M16	M20 <sup>a)</sup>											
Tension $N_{Rk,seis}$	HDA-P, HDA-T [kN]	25	35	75	95											
	HDA-PR, HDA-TR	25	35	75	-											
Shear $V_{Rk,seis}$	HDA-T	$t_{fix,min}$ [mm]	10≤	15≤	10≤	15≤	20≤	15≤	20≤	25≤	30≤	35≤	20≤	25≤	40≤	55≤
		$t_{fix,max}$ [mm]	<15	≤20	<15	<20	≤50	<20	<25	<30	<35	≤60	<25	<40	<55	≤100
	$V_{Rk}$ [kN]	39	42	56	56	70	84	84	93	102	112	144	144	165	175	
	HDA-TR	$t_{fix,min}$ [mm]	10≤	15≤	10≤	15≤	20≤	30≤	15≤	20≤	25≤	35≤	-			
		$t_{fix,max}$ [mm]	<15	≤20	<15	<20	<30	≤50	<20	<25	<35	≤60	-			
		$V_{Rk}$ [kN]	21,5	21,5	30,5	30,5	33,0	38,0	45,5	45,5	47,5	51	-			
	HDA-P [kN]		20		24		56		83							
	HDA-PR		10,5		13,5		28,5		-							

- a) HDA M20: only galvanized 5µm version is available



**Design resistance in case of seismic performance category C2**

Anchor size		M10	M12				M16				M20 <sup>a)</sup>					
Tension $N_{Rd,seis}$	HDA-P, HDA-T [kN]	16,7		23,3				50				63,3				
	HDA-PR, HDA-TR [kN]	16,7		23,3				50				-				
Shear $V_{Rd,seis}$	HDA-T	$t_{fix,min}$ [mm]	10≤	15≤	10≤	15≤	20≤	15≤	20≤	25≤	30≤	35≤	20≤	25≤	40≤	55≤
		$t_{fix,max}$ [mm]	<15	≤20	<15	<20	≤50	<20	<25	<30	<35	≤60	<25	<40	<55	≤100
		$V_{Rk}$ [kN]	26	28	37,3	37,3	46,7	56	56	62	68	74,7	96	96	110	116,7
	HDA-TR	$t_{fix,min}$ [mm]	10≤	15≤	10≤	15≤	20≤	30≤	15≤	20≤	25≤	35≤	-			
		$t_{fix,max}$ [mm]	<15	≤20	<15	<20	<30	≤50	<20	<25	<35	≤60	-			
		$V_{Rk}$ [kN]	16,2	16,2	22,9	22,9	24,8	28,6	34,2	34,2	35,7	38,3	-			
	HDA-P [kN]	16		19,2				44,8				66,4				
	HDA-PR [kN]	7,9		10,2				21,4				-				

a) HDA M20: only galvanized 5µm version is available

**Characteristic resistance in case of seismic performance category C1**

Anchor size		M10	M12				M16				M20 <sup>a)</sup>					
Tension $N_{Rk,seis}$	HDA-P, HDA-T [kN]	41,5		58				108,7				164				
	HDA-PR, HDA-TR [kN]	41,5		58				108,7				-				
Shear $V_{Rk,seis}$	HDA-T	$t_{fix,min}$ [mm]	10≤	15≤	10≤	15≤	20≤	15≤	20≤	25≤	30≤	35≤	20≤	25≤	40≤	55≤
		$t_{fix,max}$ [mm]	<15	≤20	<15	<20	≤50	<20	<25	<30	<35	≤60	<25	<40	<55	≤100
		$V_{Rk}$ [kN]	65	70	80	80	100	140	140	155	170	190	205	205	235	250
	HDA-TR	$t_{fix,min}$ [mm]	10≤	15≤	10≤	15≤	20≤	30≤	15≤	20≤	25≤	35≤	-			
		$t_{fix,max}$ [mm]	<15	≤20	<15	<20	<30	≤50	<20	<25	<35	≤60	-			
		$V_{Rk}$ [kN]	35,5	35,5	43,5	43,5	47	54,5	76	76	79	85	-			
	HDA-P [kN]	20		22				30				62				
	HDA-PR [kN]	10,5		11,5				17				31,5				

a) HDA M20: only galvanized 5µm version is available

**Design resistance in case of seismic performance category C1**

Anchor size		M10	M12				M16				M20 <sup>a)</sup>					
Tension $N_{Rd,seis}$	HDA-P, HDA-T [kN]	27,7		38,7				72,5				109,4				
	HDA-PR, HDA-TR [kN]	27,7		38,7				72,5				-				
Shear $V_{Rd,seis}$	HDA-T	$t_{fix,min}$ [mm]	10≤	15≤	10≤	15≤	20≤	15≤	20≤	25≤	30≤	35≤	20≤	25≤	40≤	55≤
		$t_{fix,max}$ [mm]	<15	≤20	<15	<20	≤50	<20	<25	<30	<35	≤60	<25	<40	<55	≤100
		$V_{Rk}$ [kN]	43,3	46,7	53,3	53,3	66,7	93,3	93,3	103,3	113,3	126,7	136,7	136,7	156,7	166,7
	HDA-TR	$t_{fix,min}$ [mm]	10≤	15≤	10≤	15≤	20≤	30≤	15≤	20≤	25≤	35≤	-			
		$t_{fix,max}$ [mm]	<15	≤20	<15	<20	<30	≤50	<20	<25	<35	≤60	-			
		$V_{Rk}$ [kN]	26,7	26,7	32,7	32,7	35,3	41	57,1	57,1	59,4	63,9	-			
	HDA-P [kN]	17,6		24				49,6				73,6				
	HDA-PR [kN]	8,6		12,8				23,7				-				

a) HDA M20: only galvanized 5µm version is available



## Materials

### Mechanical properties of HDA

Anchor size	HDA-P(F), HDA-T(F)				HDA-PR, HDA-TR		
	M10	M12	M16	M20 <sup>a)</sup>	M10	M12	M16
<b>Anchor bolt</b>							
Nominal tensile strength $f_{uk}$	800	800	800	800	800	800	800
Yield strength $f_{yk}$	640	640	640	640	600	600	600
Stressed cross-section $A_s$	58,0	84,3	157	245	58,0	84,3	157
Moment of resistance $W_{el}$	62,3	109,2	277,5	540,9	62,3	109,2	277,5
Characteristic bending resistance without sleeve $M_{Rk,s}^{b)}$	60	105	266	519	60	105	266
<b>Anchor sleeve</b>							
Nominal tensile strength $f_{uk}$	850	850	700	550	850	850	700
Yield strength $f_{yk}$	600	600	600	450	600	600	600

a) HDA M20: only a galvanized 5 $\mu$ m version is available

b) The recommended bending moment of the HDA anchor bolt may be calculated from  $M_{rec} = M_{Rd,s} / \gamma_F = M_{Rk,s} / (\gamma_{MS} \cdot \gamma_F) = (1,2 \cdot W_{el} \cdot f_{uk}) / (\gamma_{MS} \cdot \gamma_F)$ , where the partial safety factor for bolts of strength 8.8 is  $\gamma_{MS} = 1,25$ , for A4-80 equal to 1,33 and the partial safety factor for action may be taken as  $\gamma_F = 1,4$ . In case of HDA-T/TR/TF the bending capacity of the sleeve is neglected, only the capacity of the bolt is taken into account.

### Material quality

Part	Material
<b>HDA-P / HDA-T</b>	
Sleeve:	Machined steel with brazed tungsten carbide tips, galvanized to min. 5 $\mu$ m
Bolt M10 - M16:	Cold formed steel, strength 8.8, galvanized to min. 5 $\mu$ m
Bolt M20:	Cone machined, rod strength 8.8, galvanized to min. 5 $\mu$ m
Washer M10-M16:	Spring washer, galvanized or coated
Washer M20:	Washer, galvanized
Centering washer	Machined steel
<b>HDA-PR / HDA-TR</b>	
Sleeve:	Machined stainless steel with brazed tungsten carbide tips
Bolt M10 - M16:	Cone/rod: machined stainless steel
Washer	Spring washer stainless steel
Centering washer	Machined steel
<b>HDA-PF / HDA-TF</b>	
Sleeve	Machined steel with brazed tungsten carbide tips, sherardized
Bolt M10-M16:	Cold formed steel, strength 8.8, sherardized

### Anchor dimensions

Anchor size			HDA-P / HDA-PR / HDA-T / HDA-TR / HDA-PF / HDA-TF							
			M10		M12		M16		M20	
			x100/20	x125/30	x125/50	x190/40	x190/60	x250/50	x250/100	
<b>Length code letter</b>			I	L	N	R	S	V	X	
Total length of bolt	$l_B$	[mm]	150	190	210	275	295	360	410	
Diameter of bolt	$d_B$	[mm]	10	12		16		20		
<b>Total length of sleeve</b>										
HDA-P	$l_s$	[mm]	100	125	125	190	190	250	250	
HDA-T	$l_s$	[mm]	120	155	175	230	250	300	350	
Max. diameter of sleeve	$d_s$	[mm]	19	21		29		35		
Washer diameter	$d_w$	[mm]	27,5	33,5		45,5		50		
Width across flats	$S_w$	[mm]	17	19		24		30		

### HDA-P / HDA-PR

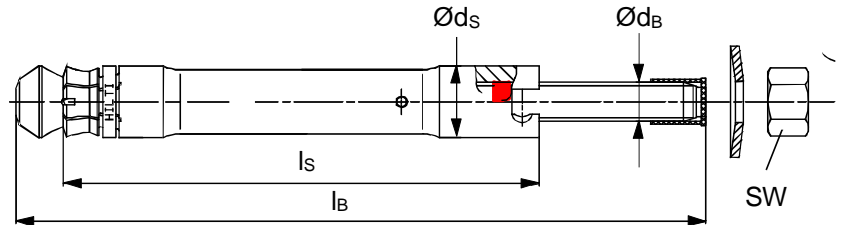

### HDA-T / HDA-TR

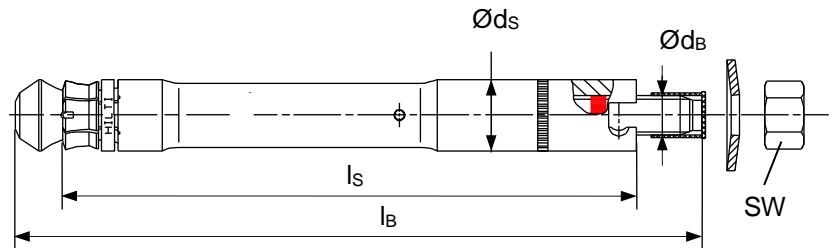

### Setting information

#### Setting details

Anchor size			HDA-P / HDA-PR / HDA-T / HDA-TR							
			M10		M12		M16		M20	
			x100/20	x125/30	x125/50	x190/40	x190/60	x250/50	x250/100	
<b>Length code letter</b>			I	L	N	R	S	V	X	
Nominal drill bit diameter	$d_0$	[mm]	20	22		30		37		
Cutting diameter of drill bit	$d_{cut,min}$	[mm]	20,10	22,10		30,10		37,15		
	$d_{cut,max}$	[mm]	20,55	22,55		30,55		37,70		
Depth of drill hole	$h_1 \geq$	[mm]	107	133		203		266		
Anchorage depth	$h_{ef}$	[mm]	100	125		190		250		
Sleeve recess	$h_{s,min}$	[mm]	2	2		2		2		
	$h_{s,max}$	[mm]	6	7		8		8		
Torque moment	$T_{inst}$	[Nm]	50	80		120		300		
<b>For HDA-P/-PR/-PF</b>										
Clearance hole	$d_f$	[mm]	12	14		18		22		
Minimum base material thickness	$h_{min}$	[mm]	180	200		270		350		
Fixture thickness	$t_{fix,min}$	[mm]	0	0		0		0		
	$t_{fix,max}$	[mm]	20	30	50	40	60	50	100	

For HDA-T/-TR/-TF								
Clearance hole	$d_f$	[mm]	21	23		32		40
Minimum base material thickness	$h_{min}$	[mm]	200- $t_{fix}$	230- $t_{fix}$	250- $t_{fix}$	310- $t_{fix}$	330- $t_{fix}$	400- $t_{fix}$ / 450- $t_{fix}$
Min. fixture thickness								
Tension load only!	$t_{fix,min}$	[mm]	10	10		15		20 / 50
Shear load <b>without</b> use of centering washer	$t_{fix,min}$	[mm]	15	15		20		25 / 50
Shear load - <b>with</b> use of centering washer	$t_{fix,min}^{b)}$	[mm]	10	10		15		20 / -
Max. fixture thickness	$t_{fix,max}$	[mm]	20	30	50	40	60	50 / 100

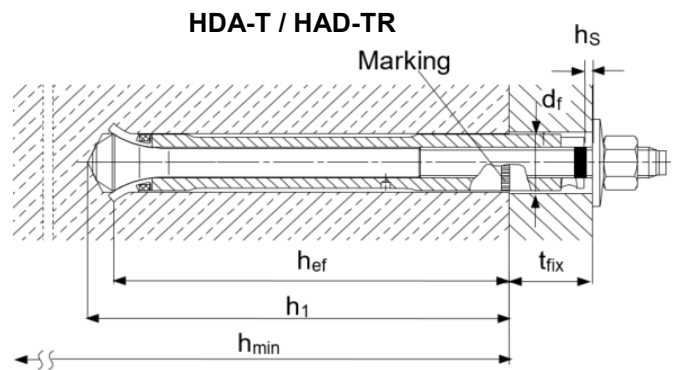
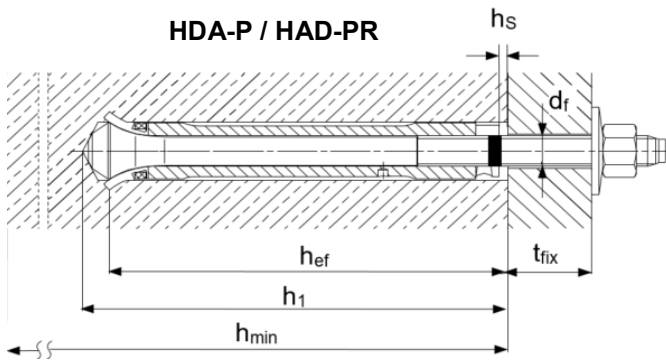

### Setting parameters

Anchor size		HDA-P / HDA-PR / HDA-T / HDA-TR							
		M10		M12		M16		M20	
		x100/20	x125/30	x125/50	x190/40	x190/60	x250/50	x250/100	
Minimum spacing	$s_{min}$	[mm]	100	125		190		250	
Minimum edge distance	$c_{min}$	[mm]	80	100		150		200	
Critical spacing for splitting failure	$s_{cr,sp}$	[mm]	300	375		570		750	
Critical edge distance for splitting failure	$c_{cr,sp}$	[mm]	150	190		285		375	
Critical spacing for concrete cone failure	$s_{cr,N}$	[mm]	300	375		570		750	
Critical edge distance for concrete cone failure	$c_{cr,N}$	[mm]	150	190		285		375	

For spacing (edge distance) smaller than critical spacing (critical edge distance) the design loads have to be reduced.

Critical spacing and critical edge distance for splitting failure apply only for non-cracked concrete. For cracked concrete only the critical spacing and critical edge distance for concrete cone failure are decisive.

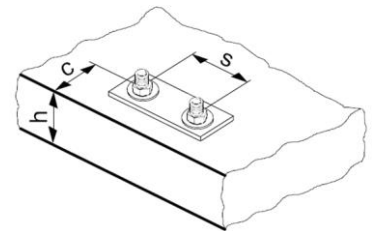

### Stop drill bit HDA

The stop drill is required for drilling in order to achieve the correct hole depth.

The setting system (tool and setting tool) is required for transferring the specific energy for the undercutting process.

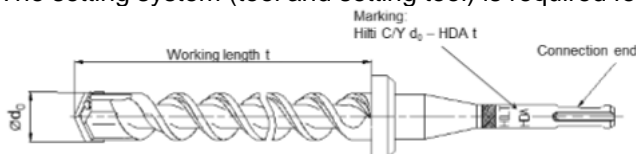

### Required stop drill bits for HDA and HDA-R

Anchor	Stop drill bit with TE-C (SDS plus) connection end	Stop drill bit with TE-Y (SDS max) connection end	Nominal working length t [mm]	Drill bit diameter d <sub>0</sub> [mm]
HDA-P/ PF/ PR M10x100/20	TE-C-HDA-B 20x100	TE-Y-HDA-B 20x100	107	20
HDA-T/ TF/ TR M10x100/20	TE-C-HDA-B 20x120	TE-Y-HDA-B 20x120	127	20
HDA-P/ PF/ PR M12x125/30 HDA-P/ PF/ PR M12x125/50	TE-C HDA-B 22x125	TE-Y HDA-B 22x125	133	22
HDA-T/ TF/ TR M12x125/30	TE-C HDA-B 22x155	TE-Y HDA-B 22x155	163	22
HDA-T/ TF/ TR M12x125/50	TE-C HDA-B 22x175	TE-Y HDA-B 22x175	183	22
HDA-P/ PF/ PR M16 x190/40 HDA-P/ PF/ PR M16 x190/60		TE-Y HDA-B 30x190	203	30
HDA-T/ TF/ TR M16x190/40		TE-Y HDA-B 30x230	243	30
HDA-T/ TF/ TR M16x190/60		TE-Y HDA-B 30x250	263	30
HDA-P M20 x250/50 HDA-P M20 x250/100		TE-Y HDA-B 37x250	266	37
HDA-T M20x250/50		TE-Y HDA-B 37x300	316	37
HDA-T M20x250/100		TE-Y HDA-B 37x350	366	37

Anchor	TE 24 a) TE 25 a)	TE 30-A36	TE 35	TE 40 TE 40 AVR	TE 56 TE 56-ATC	TE 60 TE 60-ATC	TE 70 TE 70-ATC	TE 75	TE 76 TE 76-ATC	TE 80-ATC TE 80-ATC AVR	Setting tool
HDA-P/T M10x100/20	■	■		■	■	■					TE-C-HDA-ST 20 M10
											TE-Y-HDA-ST 20 M10
HDA-P/T M12x125/30 HDA-P/T M12x125/50	■	■		■	■	■					TE-C-HDA-ST 22 M12
											TE-Y-HDA-ST 22 M12
HDA-P/T M16x190/40 HDA-P/T M16x190/60							■	■	■	■	TE-Y-HDA-ST 30 M16
							■		■	■	TE-Y-HDA-ST 37 M20

a) 1<sup>st</sup> gear

Anchor	TE 24 a) TE 25 a)	TE 30-A36	TE 35	TE 40 TE 40 AVR	TE 56 TE 56-ATC	TE 60 TE 60-ATC	TE 70 TE 70-ATC	TE 75	TE 76 TE 76-ATC	TE 80-ATC TE 80-ATC AVR	Setting tool
HDA-PR/TR M10x100/20	■	■	■	■		■					TE-C-HDA-ST 20 M10
					■	■					TE-Y-HDA-ST 20 M10
HDA-PR/TR M12x125/30 HDA-PR/TR M12x125/50	■	■	■	■		■					TE-C-HDA-ST 22 M12
					■	■					TE-Y-HDA-ST 22 M12
HDA-PR/TR M16x190/40 HDA-PR/TR M16x190/60							■	■	■	■	TE-Y-HDA-ST 30 M16

a) 1<sup>st</sup> gear

Anchor	TE 24 a) TE 25 a)	TE 30-A36	TE 35	TE 40 TE 40 AVR	TE 56 TE 56-ATC	TE 60 TE 60-ATC	TE 70 TE 70-ATC	TE 75	TE 76 TE 76-ATC	TE 80-ATC TE 80-ATC AVR	Setting tool
HDA-PF/TF M10x100/20		■	■	■		■					TE-C-HDA-ST 20 M10
HDA-PF/TF M12x125/30 HDA-PF/TF M12x125/50		■	■	■		■					TE-C-HDA-ST 22 M12
HDA-PF/TF M16x190/40 HDA-PF/TF M16x190/60							■	■	■	■	TE-Y-HDA-ST 30 M16

a) 1<sup>st</sup> gear

### Setting instructions

\*For detailed information on installation see instruction for use given with the package of the product.

**HDA-P / HDA-PR (prepositioning)**

- 1. Drilling**
- 2. Cleaning**
- 3. Inserting the anchor by hand**
- 4. Applying hammer drill**
- 5. Applying hammer drill**
- 6. Checking**
- 7. Attaching the fixture**
- 8. Attaching the belonging washer**

HDA-T / HDA-TR / HAD-TF (post-positioning)

1. Drilling

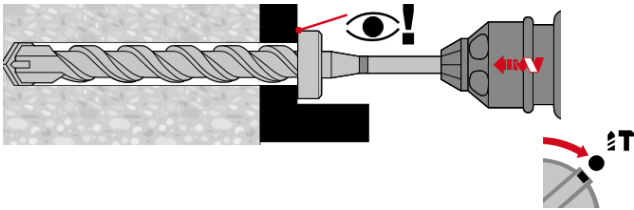

2. Cleaning

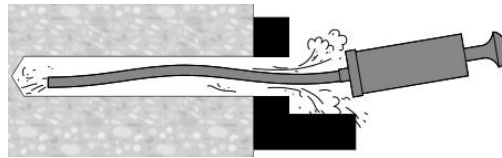

3. Inserting the anchor by hand

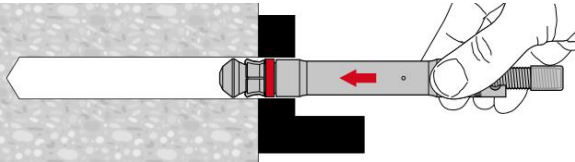

4. Applying hammerdrill

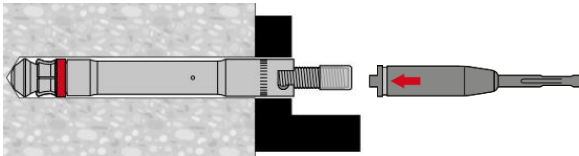

5. Checking

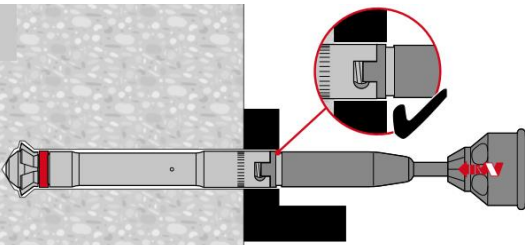

6. Checking

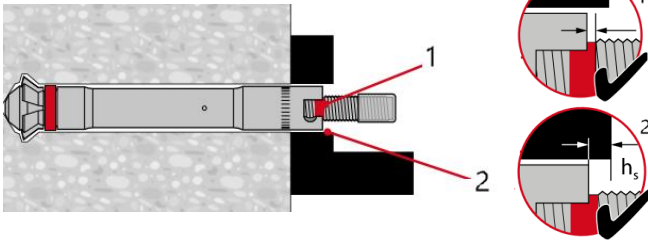

7. Attaching the belonging washer

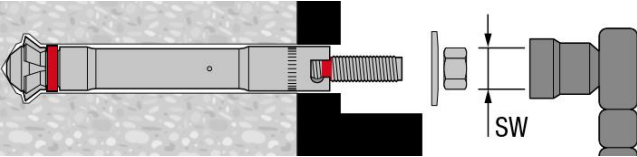

# HMU-PF Undercut anchor

Everyday standard undercut anchor for cracked concrete

Chemical anchors

Undercut

Mechanical anchors

Plastic/Light duty metal anchors

Insulation anchors

## Anchor version



HMU-PF  
(M12-M16)

## Benefits

- Reliable mechanical interlock due to consistent high quality self-undercut
- ETA approval for cracked and non-cracked concrete
- Seismic approval ETA C1
- Comes standard with a hot-dip galvanized protective coating against corrosion
- Cost efficient heavy duty anchoring solution for high volume fastenings
- Easy verification of correct setting due to red setting mark
- Optimized and matching system components enable efficient and reliable installation

## Base material



Concrete  
(non-cracked)

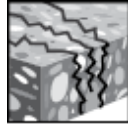

Concrete  
(cracked)

## Load conditions

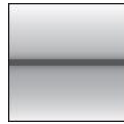

Static/  
quasi-static



Seismic  
ETA-C1



Fire  
resistance

## Installation conditions



Hammer  
drilled holes

## Other information



European  
Technical  
Assessment



CE  
conformity



PROFIS  
design  
Software

## Approvals / certificates

Description	Authority / Laboratory	No. / date of issue
European Technical Assessment <sup>a)</sup>	CSTB, Marne-la-Vallée	ETA-14/0069 / 2015-12-24
Shockproof fastenings in civil defence installations	Federal Office for Civil Protection, Bern	BZS D 14-602/2014-10-31

a) All data given in this section according to ETA-14/0069, issue 2015-12-24.



## Static resistance

### All data in this section applies to:

- Correct setting (See setting instruction)
- No edge distance and spacing influence
- *Steel* failure
- Minimum base material thickness
- Concrete C 20/25,  $f_{ck,cube} = 25 \text{ N/mm}^2$

### Effective anchorage depth for static

Anchor size		M12	M16	M16
Effective anchorage depth range	$h_{ef}$ [mm]	80	100	125

### Characteristic resistance

Anchor size			M12x80	M16x100	M16x125
<b>Non-cracked concrete</b>					
Tension $N_{Rk}$	HMU-PF	[kN]	36,1	50,5	70,6
Shear $V_{Rk}$	HMU-PF		33,7	62,8	62,8
<b>Cracked concrete</b>					
Tension $N_{Rk}$	HMU-PF	[kN]	20	36	50,3
Shear $V_{Rk}$	HMU-PF		33,7	62,8	62,8

### Design resistance

Anchor size			M12x80	M16x100	M16x125
<b>Non-cracked concrete</b>					
Tension $N_{Rd}$	HMU-PF	[kN]	24,1	33,7	47,1
Shear $V_{Rd}$	HMU-PF		27,0	50,2	50,2
<b>Cracked concrete</b>					
Tension $N_{Rd}$	HMU-PF	[kN]	13,3	24,0	33,5
Shear $V_{Rd}$	HMU-PF		27,0	48,0	50,2

### Recommended loads <sup>a)</sup>

Anchor size			M12x80	M16x100	M16x125
<b>Non-cracked concrete</b>					
Tension $N_{Rec}$	HMU-PF	[kN]	17,2	24	33,6
Shear $V_{Rec}$	HMU-PF		19,3	35,9	19,3
<b>Cracked concrete</b>					
Tension $N_{Rec}$	HMU-PF	[kN]	9,5	17,1	24,0
Shear $V_{Rec}$	HMU-PF		19,3	34,3	35,9

a) With overall partial safety factor for action  $\gamma = 1,4$ . The partial safety factors for action depend on the type of loading and shall be taken from national regulations.

## Seismic resistance (for a single anchor)

### All data in this section applies to:

- Correct setting (See setting instruction)
- No edge distance and spacing influence
- *Steel* failure
- Minimum base material thickness
- Concrete C 20/25,  $f_{ck,cube} = 25 \text{ N/mm}^2$
- $\alpha_{gap} = 1,0$  (using Hilti seismic filling set)

### Effective anchorage depth for seismic C1

Anchor size	M12	M16	M16
Effective anchorage depth range $h_{ef}$ [mm]	80	100	125

### Characteristic resistance in case of seismic performance category C1

Anchor size	M12x80	M16x100	M16x125
Tension $N_{Rk,seis}$ HMU-PF [kN]	17,3	30,6	42,8
Shear $V_{Rk,seis}$ HMU-PF [kN]	33,7	61,2	62,8

### Design resistance in case of seismic category C1

Anchor size	M12x80	M16x100	M16x125
Tension $N_{Rd,seis}$ HMU-PF [kN]	11,5	20,4	28,5
Shear $V_{Rd,seis}$ HMU-PF [kN]	27,0	40,8	50,2

## Fire resistance

### Fire resistance data according to ETA-14/0069

#### All data in this section applies to:

- Correct setting (See setting instruction)
- No edge distance and spacing influence
- *Steel* failure
- Minimum base material thickness
- Concrete C 20/25,  $f_{ck,cube} = 25 \text{ N/mm}^2$

### Recommended tension and shear resistance in cracked and non-cracked concrete

Anchor size	M12X80	M16X100	M16X125
HMU-PF	R30 $F_{Rk,fi}$ [kN]	1,7	3,1
	R120 $F_{Rk,fi}$ [kN]	0,8	1,6

For more information about different failure modes and fire resistance times please see the full ETA-14/0069 report.

## Materials

### Mechanical properties

Anchor size			M12x80	M16x100	M16x125
Nominal tensile strength	$f_{uk}$	[N/mm <sup>2</sup> ]	800	800	800
Yield strength	$f_{yk}$	[N/mm <sup>2</sup> ]	640	640	640
Stressed cross-section, thread	$A_s$	[mm <sup>2</sup> ]	84,3	157	157
Moment of resistance	$W$	[mm <sup>3</sup> ]	109	278	278
Char. bending resistance	$M^0_{Rk,s}$	[Nm]	105	266	266

### Material quality

Part	Material
Threaded bolt with cone	Carbon steel strength 8.8, hot dip galvanized to min. 50 $\mu$ m
Sleeve	Carbon steel, hot dip galvanized min. 50 $\mu$ m
Hexagon nut	Steel grade 8, hot dip galvanized min. 50 $\mu$ m
Washer	According to DIN 125-1, 140 HV, hot dip galvanized min. 50 $\mu$ m

### Letter code for anchor length

Anchor size	HMU-PF M12	M12x80/20	M12x80/35	M12x80/65
Letter code		H	I	K
Anchor size	HMU-PF M16	M16x100/30	M16x100/60	M16x125/60
Letter code		K	M	O

### Anchor dimension

Anchor size		M12x80	M16x100	M16x125
Total length of bolt $L_B$	min	133	167	222
	max	176	197	239
Diameter of sleeve	$d_s$	17,5	21,6	21,6
Length of sleeve	$l_s$	80,6	100	125

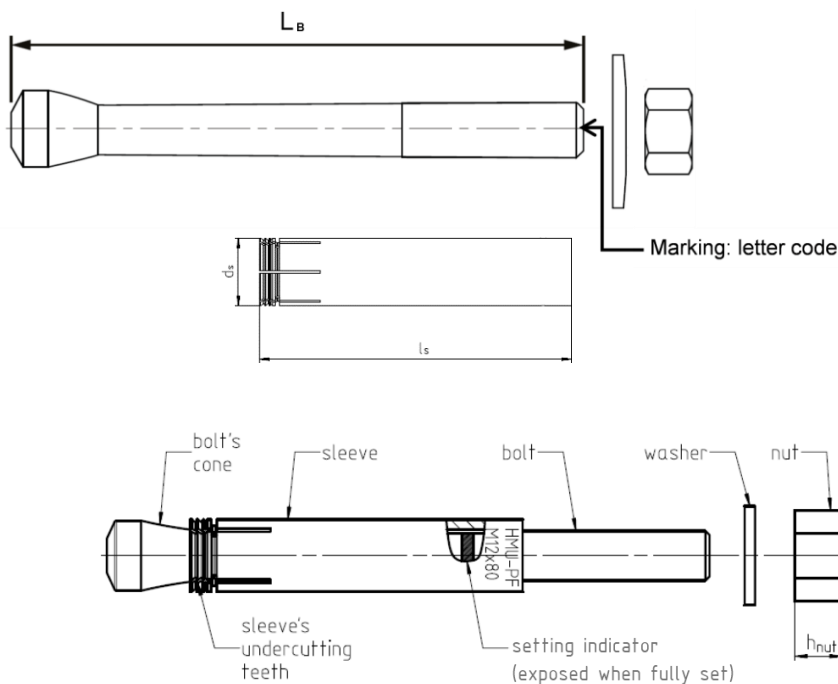

## Setting information

### Setting details of HMU-PF

Anchor size			M12x80	M16x100	M16x125
Effective anchorage depth	$h_{ef}$	[mm]	80	100	125
Nominal Diameter of drill bit	$d_0$	[mm]	18	23	
Cutting diameter of drill bit <sup>1)</sup>	$d_{cut} \leq$	[mm]	18,5	23,0	
Depth of drill hole	$h_1 =$	[mm]	92	115	140
Diameter of clearance hole in the fixture	$d_f \leq$	[mm]	14	18	
Thickness of fixture	$t_{fix}$	min.	2	0 <sup>2)</sup>	0 <sup>2)</sup>
		max	65	60	75
Torque moment	$T_{inst}$	[Nm]	45	120	
Width across nut flats	SW	[mm]	19	24	

1) Use special stop drill bit TE-C-HMU-B only.

2) When thickness of attachment is less than 3mm, big washer acc. to DIN1052 standard needs to be used.

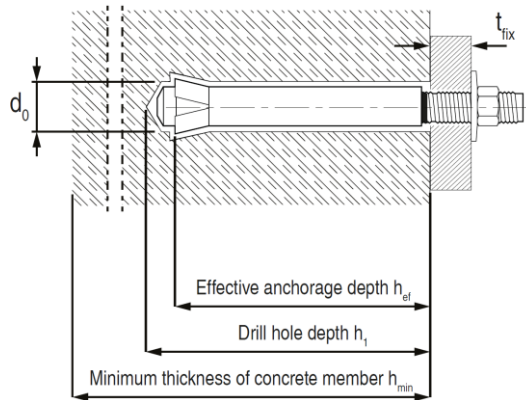

### Installation equipment

Anchor size	M12x80	M16x100	M16x125
Rotary hammer	TE 40 / TE 30-A36		
Stop drill bit	TE-C-HMU-B M12x80	TE-C-HMU-B M16x100 TE-Y-HMU-B M16x100	TE-C-HMU-B M16x125 TE-Y-HMU-B M16x125
Setting tool	TE-C-HMU-ST-M12		
Insert connections	 TE-C (SDS Plus)	 TE-C (SDS Plus)	TE-C (SDS Plus)
			 TE-Y (SDS Max)
Other tools	Blow-out bulb		

### Setting parameters

Anchor size			M12	M16	M16
Effective anchorage depth	$h_{ef}$	[mm]	80	100	125
Minimum base material thickness	$h_{min} \geq$	[mm]	160	200	250
Minimum spacing	$s_{min} \geq$	[mm]	90	100	100
Minimum edge distance	$c_{min} \geq$	[mm]	90	100	100
Critical spacing for splitting failure	$s_{cr,sp}$	[mm]	300	300	375
Critical edge distance for splitting failure	$c_{cr,sp}$	[mm]	150	160	200
Critical spacing for concrete cone failure	$s_{cr,N}$	[mm]	240	300	375
Critical edge distance for concrete cone failure	$c_{cr,N}$	[mm]	120	150	188

In case of smaller edge distance and spacing than  $c_{cr,sp}$ ,  $s_{cr,sp}$ ,  $c_{cr,N}$  and  $s_{cr,N}$  the load values shall be reduced according ETAG 001, Annex C.

Critical spacing and critical edge distance for splitting failure apply only for non-cracked concrete.

For cracked concrete only the critical spacing and critical edge distance for concrete cone failure are decisive.

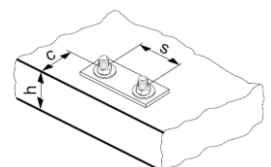



## Setting instruction





\*For detailed information on installation see instruction for use given with the package of the product.

Setting instruction for HMU-PF	
<p><b>1. Drilling</b></p>	<p><b>2. Cleaning</b></p>
<p><b>3. Inserting the anchor by hand</b></p>	<p><b>4. Applying hammer drill</b></p>
<p><b>5. Applying hammer drill</b></p>	<p><b>6. Checking</b></p>
<p><b>7. Attaching the fixture</b></p>	<p><b>8. Attaching the belonging washer</b></p>

# HSC Undercut anchors

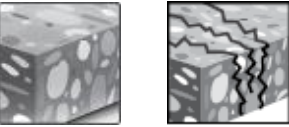
Ultimate-performance undercut anchor for shallow embedment depth

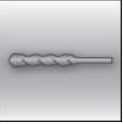
Anchor version	Benefits
 <p>HSC-A HSC-AR (M8-M12)</p>	<ul style="list-style-type: none"> <li>- The perfect solution for small edge and space distance</li> <li>- Suitable for thin concrete blocks due to low embedment depth</li> <li>- Seismic design with ETA C2 approval</li> <li>- Suitable for cracked concrete</li> <li>- Self-cutting undercut anchor</li> <li>- Available as bolt version for through applications</li> <li>- Stainless steel available for external applications</li> </ul>
 <p>HSC-I HSC-IR (M6-M12)</p>	

Base material	Load conditions
 <p>Concrete (non-cracked)    Concrete (cracked)</p>	 <p>Static/quasi-static    Shock    Fire resistance    Seismic ETA-C2</p>
Installation conditions	Other information
 <p>Hammer drilled holes</p>	 <p>European Technical Assessment    CE conformity    PROFIS design Software    Corrosion resistance A4 316</p>

## Approvals / certificates

Description	Authority / Laboratory	No. / date of issue
European Technical Assessment <sup>a)</sup>	CSTB, Marne-la-Vallée	ETA-02/0027 / 2018-07-04
Fire test report <sup>a)</sup>	CSTB, Marne-la-Vallée	ETA-02/0027 / 2018-07-04
Shockproof fastenings in civil defence installations	Federal Office for Civil Protection, Bern	BZS D 06-601 / 2006-07-10

a) All data given in this section according to ETA-02/0027 issue 2018-07-04.

Chemical anchors    Undercut    Mechanical anchors    Plastic/Light duty metal anchors    Insulation anchors

## Static resistance

### All data in this section applies to:

- Correct setting (See setting instruction)
- No edge distance and spacing influence
- *Steel* failure
- Minimum base material thickness
- Concrete C20/25,  $f_{ck,cube} = 25 \text{ N/mm}^2$

### HSC-A (R)

#### Effective anchorage depth of HSC-A (R)

Anchor size		M8	M8	M10	M12
Effective anchorage depth range	$h_{ef}$ [mm]	40	50	40	60

#### Characteristic resistance of HSC-A (R)

Anchor size			M8 x 40	M8 x 50	M10 x 40	M12 x 60
<b>Non-cracked concrete</b>						
Tension $N_{Rk}$	HSC-A, HSC-AR	[kN]	12,8	17,8	12,8	23,4
Shear $V_{Rk}$	HSC-A	[kN]	14,6	14,6	23,2	33,7
	HSC-AR		12,8	12,8	20,3	29,5
<b>Cracked concrete</b>						
Tension $N_{Rk}$	HSC-A, HSC-AR	[kN]	9,1	12,7	9,1	16,7
Shear $V_{Rk}$	HSC-A	[kN]	14,6	14,6	18,2	33,5
	HSC-AR		12,8	12,8	18,2	29,5

#### Design resistance of HSC-A (R)

Anchor size			M8 x 40	M8 x 50	M10 x 40	M12 x 60
<b>Non-cracked concrete</b>						
Tension $N_{Rd}$	HSC-A, HSC-AR	[kN]	8,5	11,9	8,5	15,6
Shear $V_{Rd}$	HSC-A	[kN]	11,7	11,7	17,0	27,0
	HSC-AR		8,2	8,2	13,0	18,9
<b>Cracked concrete</b>						
Tension $N_{Rd}$	HSC-A, HSC-AR	[kN]	6,1	8,5	6,1	11,2
Shear $V_{Rd}$	HSC-A	[kN]	11,7	11,7	12,1	22,3
	HSC-AR		8,2	8,2	12,1	18,9

#### Recommended loads <sup>a)</sup> of HSC-A (R)

Anchor size			M8 x 40	M8 x 50	M10 x 40	M12 x 60
<b>Non-cracked concrete</b>						
Tension $N_{Rec}$	HSC-A, HSC-AR	[kN]	6,1	8,5	6,1	11,2
Shear $V_{Rec}$	HSC-A	[kN]	8,3	8,3	12,1	19,3
	HSC-AR		5,9	5,9	9,3	13,5
<b>Cracked concrete</b>						
Tension $N_{Rec}$	HSC-A, HSC-AR	[kN]	4,3	6,1	4,3	8,0
Shear $V_{Rec}$	HSC-A	[kN]	8,3	8,3	8,7	15,9
	HSC-AR		5,9	5,9	8,7	13,5

a) With overall partial safety factor for action  $\gamma = 1,4$ . The partial safety factors for action depend on the type of loading and shall be taken from national regulations.



## HSC-I (R)

### Effective anchorage depth of HSC-I (R)

Anchor size	M6	M8	M10	M10	M12
Eff. anchorage depth range $h_{ef}$ [mm]	40	40	50	60	60

### Characteristic resistance of HSC-I (R)

Anchor size		M6 x 40	M8 x 40	M10 x 50	M10 x 60	M12 x 60
<b>Non-cracked concrete</b>						
Tension $N_{Rk}$	HSC-I, HSC-IR [kN]	12,8	12,8	17,8	23,4	23,4
Shear $V_{Rk}$	HSC-I [kN]	8,0	12,2	15,2	15,2	18,2
	HSC-IR [kN]	7,0	10,7	13,3	13,3	16,0
<b>Cracked concrete</b>						
Tension $N_{Rk}$	HSC-I, HSC-IR [kN]	9,1	9,1	12,7	12,7	16,7
Shear $V_{Rk}$	HSC-I [kN]	8,0	12,2	15,2	15,2	18,2
	HSC-IR [kN]	7,0	10,7	13,3	13,3	16,0

### Design resistance of HSC-I (R)

Anchor size		M6 x 40	M8 x 40	M10 x 50	M10 x 60	M12 x 60
<b>Non-cracked concrete</b>						
Tension $N_{Rd}$	HSC-I [kN]	8,5	8,5	11,9	15,6	15,6
	HSC-IR [kN]	7,5	8,5	11,9	14,2	15,6
Shear $V_{Rd}$	HSC-I [kN]	6,4	9,8	12,2	12,2	14,6
	HSC-IR [kN]	4,5	6,9	8,5	8,5	10,3
<b>Cracked concrete</b>						
Tension $N_{Rd}$	HSC-I, HSC-IR [kN]	6,1	6,1	8,5	11,2	11,2
Shear $V_{Rd}$	HSC-I [kN]	6,4	9,8	12,2	12,2	14,6
	HSC-IR [kN]	4,5	6,9	8,5	8,5	10,3

### Recommended loads <sup>a)</sup> of HSC-I (R)

Anchor size		M6 x 40	M8 x 40	M10 x 50	M10 x 60	M12 x 60
<b>Non-cracked concrete</b>						
Tension $N_{Rec}$	HSC-I [kN]	6,1	6,1	8,5	11,2	11,2
	HSC-IR [kN]	5,4	6,1	8,5	10,1	11,2
Shear $V_{Rec}$	HSC-I [kN]	4,6	7,0	8,7	8,7	10,4
	HSC-IR [kN]	3,2	4,9	6,1	6,1	7,3
<b>Cracked concrete</b>						
Tension $N_{Rec}$	HSC-I, HSC-IR [kN]	4,3	4,3	6,1	8,0	8,0
Shear $V_{Rec}$	HSC-I [kN]	4,6	7,0	8,7	8,7	10,4
	HSC-IR [kN]	3,2	4,9	6,1	6,1	7,3

a) With overall partial safety factor for action  $\gamma = 1,4$ . The partial safety factors for action depend on the type of loading and shall be taken from national regulations.

### Seismic loading (for a single anchor)

**All data in this section applies to:**

- Correct setting (See setting instruction)
- No edge distance and spacing influence
- *Steel* failure
- Cracked concrete
- Minimum base material thickness
- Concrete C 20/25,  $f_{ck,cube} = 25 \text{ N/mm}^2$
- $\alpha_{gap} = 1,0$  (using Hilti seismic filling set)

**Characteristic resistance for HSC-A in case of seismic performance C2**

Anchor size			M8 x 40	M8 x 50	M10 x 40
Tension $N_{Rk,seis}$	HSC-A	[kN]	2,4	2,4	4,5
Shear $V_{Rk,seis}$	HSC-A	[kN]	12,4	12,4	15,5

**Design resistance for HSC-A in case of seismic performance C2**

Anchor size			M8 x 40	M8 x 50	M10 x 40
Tension $N_{Rd,seis}$	HSC-A	[kN]	1,6	1,6	3,0
Shear $V_{Rd,seis}$	HSC-A	[kN]	9,9	9,9	10,3

**Recommended resistance for HSC-A in case of seismic performance C2**

Anchor size			M8 x 40	M8 x 50	M10 x 40
Tension $N_{Rd,seis}$	HSC-A	[kN]	1,1	1,1	2,1
Shear $V_{Rd,seis}$	HSC-A	[kN]	7,1	7,1	7,4

## Fire resistance

### All data in this section applies to:

- Correct setting (See setting instruction)
- No edge distance and spacing influence
- *Steel* failure
- Minimum base material thickness
- Concrete C 20/25,  $f_{ck,cube} = 25 \text{ N/mm}^2$

### HSC-A (R)

#### Effective anchorage depth of HSC-A (R)

Anchor size	M8	M8	M10	M12
Eff. anchorage depth range $h_{ef}$ [mm]	40	50	40	60

#### Characteristic/design<sup>1</sup> resistance in uncracked concrete and cracked concrete

Anchor size		M8 x 40	M8 x 50	M10 x 40	M12 x 60
<b>Fire Exposure R30</b>					
Tension $N_{Rk,fi}$	HSC-A [kN]	0,4	0,4	0,9	1,7
	HSC-AR	0,7	0,7	1,5	2,5
Shear $V_{Rk,fi}$	HSC-A [kN]	0,4	0,4	0,9	1,7
	HSC-AR	0,7	0,7	1,5	2,5
<b>Fire Exposure R120</b>					
Tension $N_{Rk,fi}$	HSC-A [kN]	0,2	0,2	0,5	0,8
	HSC-AR	0,4	0,4	0,8	1,3
Shear $V_{Rk,fi}$	HSC-A [kN]	0,2	0,2	0,5	0,8
	HSC-AR	0,4	0,4	0,8	1,3

1) The safety factor is  $\gamma=1.0$  for all load cases

### HSC-I (R)

#### Effective anchorage depth of HSC-I (R)

Anchor size	M6	M8	M10	M10	M12
Eff. anchorage depth range $h_{ef}$ [mm]	40	40	50	60	60

#### Characteristic/design<sup>1</sup> resistance in uncracked concrete and cracked concrete

Anchor size		M6 x 40	M8 x 40	M10 x 50	M10 x 60	M12 x 60
<b>Fire Exposure R30</b>						
Tension $N_{Rk,fi}$	HSC-I [kN]	0,2	0,4	0,9	0,4	1,7
	HSC-IR	0,2	0,7	1,5	0,7	2,5
Shear $V_{Rk,fi}$	HSC-I [kN]	0,2	0,4	0,9	0,4	1,7
	HSC-IR	0,2	0,7	1,5	0,7	2,5
<b>Fire Exposure R120</b>						
Tension $N_{Rk,fi}$	HSC-I [kN]	0,1	0,2	0,5	0,2	0,8
	HSC-IR	0,1	0,4	0,8	0,4	1,3
Shear $V_{Rk,fi}$	HSC-I [kN]	0,1	0,2	0,5	0,2	0,8
	HSC-IR	0,1	0,4	0,8	0,4	1,3

1) The safety factor is  $\gamma=1.0$  for all load cases

## Materials

### Mechanical properties for HSC-A (R)

Anchor size			M8 x 40	M8 x 50	M10 x 40	M12 x 60
Nominal tensile strength	$f_{uk}$	HSC-A	800	800	800	800
		HSC-AR	700	700	700	700
Yield strength	$f_{yk}$	HSC-A	640	640	640	640
		HSC-AR	450	450	450	450
Stressed cross-section for bolt version	$A_{s,A}$	HSC-A	36,6	36,6	58,0	84,3
		HSC-AR				
Moment of resistance	W	HSC-A	31,2	31,2	62,3	109,2
		HSC-AR				
Design bending resistance Without sleeve	$M_{Rd,s}$	HSC-A	24	24	48	84
		HSC-AR	16,7	16,7	33,3	59,0

### Mechanical properties for HSC-I (R)

Anchor size			M6 x 40	M8 x 40	M10 x 50	M10 x 60	M12 x 60
Nominal tensile strength	$f_{uk}$	HSC-I	800	800	800	800	800
		HSC-IR	700	700	700	700	700
Yield strength	$f_{yk}$	HSC-I	640	640	640	640	640
		HSC-IR	355	355	350	350	340
Stressed cross-section for internal thread version	$A_{s,I}$	HSC-I	22,0	28,3	34,6	34,6	40,8
		HSC-IR					
Stressed cross-section for external thread version	$A_{s,A}$	HSC-I	20,1	36,6	58,0	58,0	84,3
		HSC-IR					
Moment of resistance	W	HSC-I	12,7	31,2	62,3	62,3	109,2
		HSC-IR					
Design bending resistance without sleeve	$M_{Rd,s}$	HSC-I	9,6	24	48	48	84
		HSC-IR	7,1	16,7	33,3	33,3	59,0

### Material quality

Part	Material	
<b>Metal parts made of zinc coated steel</b>		
HSC-A HSC-I	Cone bolt with internal thread	Carbon steel strength 8.8, galvanized to min. 5 $\mu$ m
	Cone bolt with internal thread	
	Expansion sleeve	Galvanized to min. 5 $\mu$ m
	Washer	
	Hexagon nut	
<b>HSC-AR / HSC-IR Stainless steel</b>		
HSC-AR HSC-IR	Cone bolt with internal thread	A4-70, Stainless steel 1.4401, 1.4571 EN 10088-1:2014
	Cone bolt with internal thread	
	Expansion sleeve	Stainless steel 1.4401, 1.4571 EN 10088-1:2014
	Washer	
	Hexagon nut	

### Anchor dimension of HSC-A (R)

Anchor size		M8 x 40	M8 x 50	M10 x 40	M12 x 60
Diameter of cone bolt	b [mm]	13,5	13,5	15,5	17,5
Length of expansion sleeve	l <sub>s</sub> [mm]	40,8	50,8	40,8	60,8
Diameter of expansion sleeve	d [mm]	13,5	13,5	15,5	17,5
Diameter of washer	e [mm]	16	16	20	24

### Anchor dimension of HSC-I (R)

Anchor size		M6 x 40	M8 x 40	M10 x 50	M10 x 60	M12 x 60
Length of cone bolt	l <sub>b</sub> [mm]	43,8	43,8	54,8	64,8	64,8
Diameter of cone bolt	b [mm]	13,5	13,5	15,5	13,5	17,5
Length of expansion sleeve	l <sub>s</sub> [mm]	40,8	40,8	50,8	50,8	60,8
Diameter of expansion sleeve	d [mm]	13,5	15,5	17,5	17,5	19,5

### Setting information

#### Setting details of HSC-A (R)

Anchor size		M8 x 40	M8 x 50	M10 x 40	M12 x 60
Effective anchorage depth	h <sub>ef</sub> [mm]	40	50	40	60
Nominal Diameter of drill bit	d <sub>0</sub> [mm]	14	14	16	18
Cutting diameter of drill bit <sup>1)</sup>	d <sub>cut</sub> [mm]	14,5	14,5	16,5	18,5
Maximum fastening thickness	t <sub>fix</sub> [mm]	15	15	20	20
Depth of drill hole	h <sub>1</sub> [mm]	46	56	46,5	68
Diameter of clearance hole in the fixture	d <sub>f</sub> ≤ [mm]	9	9	12	14
Torque moment	T <sub>inst</sub> [Nm]	10	10	20	30
Width across nut flats	SW [mm]	13	13	17	19

#### Setting details of HSC-I (R)

Anchor size		M6 x 40	M8 x 40	M10 x 50	M10 x 60	M12 x 60
Effective anchorage depth	h <sub>ef</sub> [mm]	40	40	50	60	60
Nominal Diameter of drill bit	d <sub>0</sub> [mm]	14	16	18	18	20
Cutting diameter of drill bit <sup>1)</sup>	d <sub>cut</sub> ≤ [mm]	14,5	16,5	18,5	18,5	20,5
Depth of drill hole	h <sub>1</sub> = [mm]	46	46,5	56	68	68,5
Diameter of clearance hole in the fixture	d <sub>f</sub> ≤ [mm]	7	9	12	12	14
Torque moment	T <sub>inst</sub> [Nm]	10	10	20	30	30
Width across nut flats	SW [mm]	10	13	17	17	19
Screwing depth	min s mm	6	8	10	10	12
	max s mm	16	22	28	28	30

#### Installation equipment for HSC-A (R)

Anchor size		M8 x 40	M8 x 50	M10 x 40	M12 x 60
Rotary hammer for setting		TE 7-C; TE 7-A; TE 16; TE 16-C; TE 16-M; TE 25; TE 30; TE 35		TE 7-C; TE 7-A; TE 25; TE 35	TE 16; TE 16-C; TE 16-M; TE 25; TE 30; TE 35; TE 40; TE 40-AVR
Stepped drill bit	TE-C-HSC-B	14x40	14x50	16x40	18x60
Setting tool	TE-C-HSC-MW	14	14	16	18

### Installation equipment for HSC-A (R)

Anchor size		M8 x 40	M8 x 50	M10 x 40	M12 x 60
Rotary hammer for setting		TE 7-C; TE 7-A; TE 16; TE 16-C; TE 16-M; TE 25; TE 30; TE 35		TE 7-C; TE 7-A; TE 25; TE 35	TE 16; TE 16-C; TE 16-M; TE 25; TE 30; TE 35; TE 40; TE 40-AVR
Stepped drill bit	TE-C-HSC-B	14x40	14x50	16x40	18x60
Setting tool	TE-C-HSC-MW	14	14	16	18

### Installation equipment for HSC-I (R)

Anchor size		M6 x 40	M8 x 40	M10 x 50	M10 x 60	M12 x 60
Rotary hammer for setting		TE 7-C; TE 7-A; TE 16; TE 16-C; TE 16-M; TE 25; TE 30; TE 35				TE 16; TE 16-C; TE 16-M; TE 25; TE 30; TE 35; TE 40; TE 40-AVR
Stepped drill bit	TE-C-HSC-B	14x40	16x40	18x50	18x60	20x60
Setting tool	TE-C-HSC-MW	14	16	18	18	20
Insert tool	TE-C-HSC-EW	14	16	18	18	20

### Setting parameters for HSC-A (R)

Anchor size		M8 x 40	M8 x 50	M10 x 40	M12 x 60
Effective anchorage depth	$h_{ef}$ [mm]	40	50	40	60
Minimum base material thickness	$h_{min} \geq$ [mm]	100	100	100	130
Minimum spacing	$s_{min} \geq$ [mm]	40	50	40	60
Minimum edge distance	$c_{min} \geq$ [mm]	40	50	40	60
Critical spacing for splitting failure	$s_{cr,sp}$ [mm]	130	170	120	180
Critical edge distance for splitting failure	$c_{cr,sp}$ [mm]	65	85	60	90
Critical spacing for concrete cone failure	$s_{cr,N}$ [mm]	120	150	120	180
Critical edge distance for concrete cone failure	$c_{cr,N}$ [mm]	60	75	60	90

### Setting parameters for HSC-I (R)

Anchor size		M6 x 40	M8 x 40	M10 x 50	M10 x 60	M12 x 60
Effective anchorage depth	$h_{ef}$ [mm]	40	40	50	60	60
Minimum base material thickness	$h_{min} \geq$ [mm]	100	100	100	100	130
Minimum spacing	$s_{min} \geq$ [mm]	40	40	40	50	60
Minimum edge distance	$c_{min} \geq$ [mm]	40	40	50	60	60
Critical spacing for splitting failure	$s_{cr,sp}$ [mm]	130	120	170	180	180
Critical edge distance for splitting failure	$c_{cr,sp}$ [mm]	65	60	85	90	90
Critical spacing for concrete cone failure	$s_{cr,N}$ [mm]	120	120	150	180	180
Critical edge distance for concrete cone failure	$c_{cr,N}$ [mm]	60	60	75	90	90

In case of smaller edge distance and spacing than  $c_{cr,sp}$ ,  $s_{cr,sp}$ ,  $c_{cr,N}$  and  $s_{cr,N}$  the load values shall be reduced according ETAG 001, Annex C

Critical spacing and critical edge distance for splitting failure apply only for non-cracked concrete.

For cracked concrete only the critical spacing and critical edge distance for concrete cone failure are decisive.

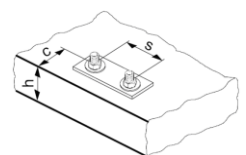

## Setting instruction

\*For detailed information on installation see instruction for use given with the package of the product.

Setting instruction for HSC-A (R)	
<p><b>1. Drilling</b></p>	<p><b>2. Cleaning</b></p>
<p><b>3. Inserting the anchor by hand</b></p>	<p><b>4. Applying hammer drill</b></p>
<p><b>5. Applying hammer drill</b></p>	<p><b>6. Checking</b></p>
<p><b>7. Attaching the fixture</b></p>	<p><b>8. Attaching the belonging washer</b></p>



Setting instruction for HSC-I (R)

1. Drilling

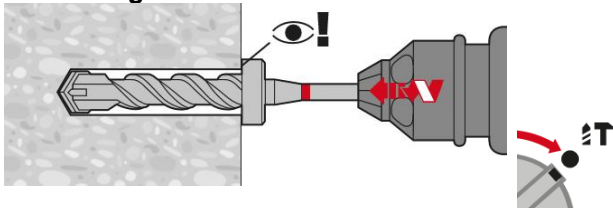

2. Cleaning

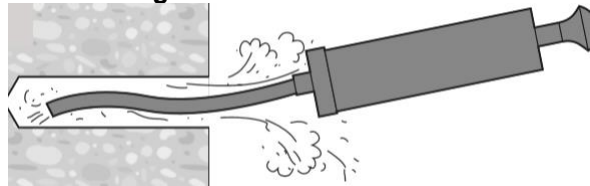

3. Inserting the anchor by hand

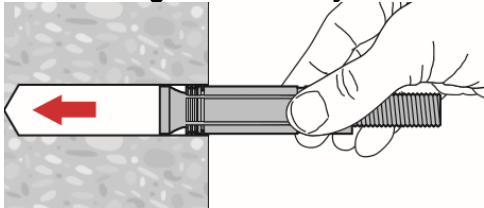

4. Inserting the tool HSC-EW14

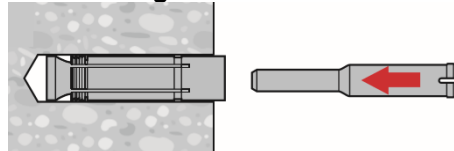

5. Applying hammer drill

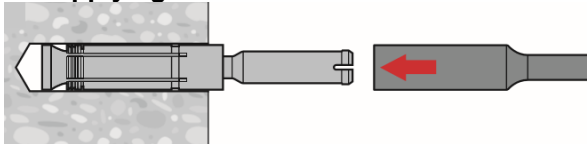

6. Applying hammer drill



7. Applying hammer drill

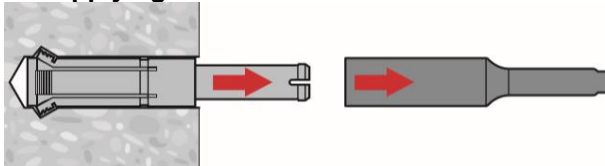

8. Checking

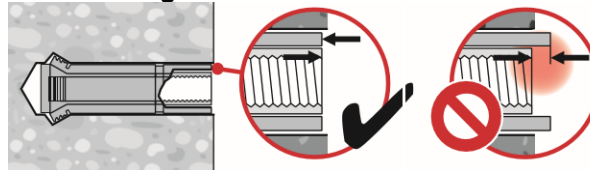

9. Attaching the fixture



10. Attaching the belonging washer

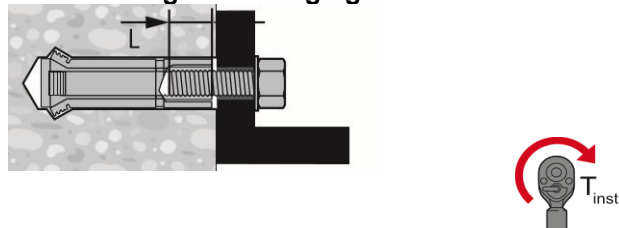

11.

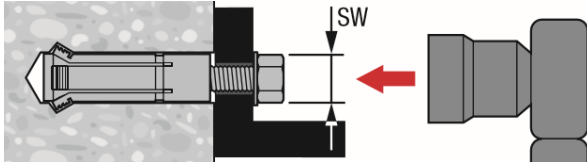

# HSL-3 / HSL-3-R expansion anchor

## Ultimate-performance heavy-duty expansion anchor

Anchor versions		Benefits
		<ul style="list-style-type: none"> <li>- Suitable for cracked concrete C20/25 to C50/60</li> <li>- Suitable for all dynamic loads: seismic C1 and C2 <sup>a)</sup>, shock and fatigue</li> <li>- Can be installed with hammer or diamond drilling for same performance</li> <li>- Top shear performance due to high strength expansion and shear sleeves</li> <li>- Automatic torque control with HSL-3-B</li> <li>- Length can be customized to a specific project need</li> <li>- Easily removable for temporary fastening or retrofit</li> </ul>

a) Condition valid only for HSL-3 carbon steel version

Base material	Load conditions					
Concrete (non-cracked)                  Concrete (cracked)	Static/quasi-static	Seismic ETA-C1, C2	Fatigue	Shock	Fire resistance	
Installation conditions	Other information					
Hammer drilled holes                  Diamond cored holes                  Variable embedment depth	European Technical Assessment	CE conformity	PROFIS Anchor design Software	A4 316	Corrosion resistance	

### Approvals/certificates

Description	Authority / Laboratory	No. / Date of issue
European technical Assessment <sup>a)</sup>	CSTB, Marne-la-Vallée	ETA-02/0042 / 2017-11-22
Fire test report	CSTB, Marne-la-Vallée	ETA-02/0042 / 2017-11-22
ICC-ES report incl. seismic <sup>b)c)</sup>	ICC evaluation service	ESR 1545 / 2017-01
Shock approval <sup>c)</sup>	Civil Protection of Switzerland	BZS D 08-601
Fire performance <sup>c)</sup>	Exova Warringtonfire	WF 327804/A / 2013-07-10
ACI 349-01 nuclear suitability <sup>c)</sup>	Wollmershauser consulting	WC 11-02 / 2011-09

a) All data given in this section according to ETA-02/0042, issue 2017-07-20.  
 b) For more details on Technical Data according to ICC please consult the relevant HNA FTM.  
 c) Certificate valid only for HSL-3 / HSL-3-G / HSL-3-B / HSL-3-SK / HSL-3-SH

## Static and quasi-static resistance (for a single anchor)

### All data in this section applies to:

- Correct setting (See setting instruction)
- No edge distance and spacing influence
- *Steel* failure
- Minimum base material thickness
- Concrete C 20/25,  $f_{ck,cube}=25$  N/mm<sup>2</sup>
- Values for HSL-3-R, HSL-3-SKR and HSL-3-GR only applicable for hammer drilling.

### Effective anchorage depth <sup>a)</sup>

Anchor size		M8			M10			M12		
Eff. Anchorage depth	$h_{ef}$ [mm]	$h_{ef,1}^{b)}$	$h_{ef,2}$	$h_{ef,3}$	$h_{ef,1}^{b)}$	$h_{ef,2}$	$h_{ef,3}$	$h_{ef,1}^{b)}$	$h_{ef,2}$	$h_{ef,3}$
		60	80	100	70	90	110	80	105	130
Anchor size		M16			M20			M24		
Eff. Anchorage depth	$h_{ef}$ [mm]	$h_{ef,1}$	$h_{ef,2}$	$h_{ef,3}$	$h_{ef,1}$	$h_{ef,2}$	$h_{ef,3}$	$h_{ef,1}$	$h_{ef,2}$	$h_{ef,3}$
		100	125	150	125	155	185	150	180	210

a) HSL-3-SH, HSL-3-SK and HSL-3-SKR only available in sizes M8-M12

b) HSL-3-SH, HSL-3-SK and HSL-3-SKR can only be set in position 1.

### Characteristic resistance

Anchor size		M8			M10			M12			
<b>Non-cracked concrete</b>											
Tension $N_{Rk}$	HSL-3 / HSL-3-B HSL-3-G HSL-3-SH / HSL-3-SK <sup>a)</sup>	[kN]	23,5	29,3	29,3	29,6	43,1	46,6	36,1	54,3	67,4
	HSL-3-R / HSL-3-SKR <sup>a)</sup> HSL-3-GR	[kN]	20,0	20,0	20,0	29,6	40,6	40,6	36,1	54,3	59,0
Shear $V_{Rk}$	HSL-3 / HSL-3-B	[kN]	31,1	31,1	31,1	59,2	60,5	60,5	72,3	89,6	89,6
	HSL-3-G	[kN]	26,1	26,1	26,1	41,8	41,8	41,8	59,3	59,3	59,3
	HSL-3-SH / HSL-3-SK <sup>a)</sup>	[kN]	31,1	-	-	59,2	-	-	72,3	-	-
	HSL-3-R, HSL-3-SKR <sup>a)</sup>	[kN]	44,4	44,4	44,4	59,2	62,7	62,7	72,3	81,4	81,4
	HSL-3-GR	[kN]	40,3	40,3	40,3	58,9	58,9	58,9	72,3	78,7	78,7
<b>Cracked concrete</b>											
Tension $N_{Rk}$	HSL-3 / HSL-3-B HSL-3-G HSL-3-SH / HSL-3-SK <sup>a)</sup>	[kN]	12,0	12,0	12,0	16,0	16,0	16,0	25,8	24,0	24,0
	HSL-3-R / HSL-3-SKR <sup>a)</sup> HSL-3-GR	[kN]	12,0	12,0	12,0	16,0	16,0	16,0	25,8	24,0	24,0
Shear $V_{Rk}$	HSL-3 / HSL-3-B	[kN]	30,1	31,1	31,1	42,2	60,5	60,5	51,5	77,5	89,6
	HSL-3-G	[kN]	26,1	26,1	26,1	41,8	41,8	41,8	51,5	59,3	59,3
	HSL-3-SH / HSL-3-SK <sup>a)</sup>	[kN]	30,1	-	-	42,2	-	-	51,5	-	-
	HSL-3-R, HSL-3-SKR <sup>a)</sup>	[kN]	33,5	44,4	44,4	42,2	61,5	62,7	51,5	77,5	81,4
	HSL-3-GR	[kN]	33,5	40,3	40,3	42,2	58,9	58,9	51,5	77,5	78,7
Anchor size		M16			M20			M24			
<b>Non-cracked concrete</b>											
Tension $N_{Rk}$	HSL-3 / HSL-3-B HSL-3-G	[kN]	50,5	65,0	65,0	70,6	95,0	95,0	92,8	100,0	100,0
	HSL-3-R HSL-3-GR	[kN]	50,5	65,0	65,0	70,6	95,0	95,0	-	-	-
Shear $V_{Rk}$	HSL-3 / HSL-3-B	[kN]	101,0	141,2	158,5	141,2	186,0	186,0	185,5	204,5	204,5
	HSL-3-G	[kN]	101,0	120,6	120,6	141,2	155,3	155,3	185,5	204,5	204,5
	HSL-3-R	[kN]	101,0	128,2	128,2	141,2	145,2	145,2	-	-	-
	HSL-3-GR	[kN]	101,0	129,5	129,5	141,2	151,9	151,9	-	-	-

Anchor size		M16			M20			M24			
<b>Cracked concrete</b>											
Tension $N_{Rk}$	HSL-3 / HSL-3-B HSL-3-G	[kN]	36,0	36,0	36,0	50,3	50,0	50,0	66,1	65,0	65,0
	HSL-3-R HSL-3-GR		36,0	36,0	36,0	50,3	50,0	50,0	-	-	-
Shear $V_{Rk}$	HSL-3 / HSL-3-B	[kN]	72,0	100,6	132,3	100,6	138,9	181,2	132,3	173,9	204,5
	HSL-3-G		72,0	100,6	120,6	100,6	138,9	155,3	132,3	173,9	204,5
	HSL-3-R		72,0	100,6	128,2	100,6	138,9	145,2	-	-	-
	HSL-3-GR		72,0	100,6	129,5	100,6	138,9	151,9	-	-	-

a) HSL-3-SH, HSL-3-SK and HSL-3-SKR can only be set in position 1.

### Effective anchorage depth <sup>a)</sup>

Anchor size		M8			M10			M12		
Eff. Anchorage depth $h_{ef}$	[mm]	$h_{ef,1}^{b)}$	$h_{ef,2}$	$h_{ef,3}$	$h_{ef,1}^{b)}$	$h_{ef,2}$	$h_{ef,3}$	$h_{ef,1}^{b)}$	$h_{ef,2}$	$h_{ef,3}$
		60	80	100	70	90	110	80	105	130
Anchor size		M16			M20			M24		
Eff. Anchorage depth $h_{ef}$	[mm]	$h_{ef,1}$	$h_{ef,2}$	$h_{ef,3}$	$h_{ef,1}$	$h_{ef,2}$	$h_{ef,3}$	$h_{ef,1}$	$h_{ef,2}$	$h_{ef,3}$
		100	125	150	125	155	185	150	180	210

a) HSL-3-SH, HSL-3-SK and HSL-3-SKR only available in sizes M8-M12

b) HSL-3-SH, HSL-3-SK and HSL-3-SKR can only be set in position 1.

### Design resistance

Anchor size		M8			M10			M12			
<b>Non-cracked concrete</b>											
Tension $N_{Rd}$	HSL-3 / HSL-3-B HSL-3-G HSL-3-SH / HSL-3-SK <sup>a)</sup>	[kN]	13,0	19,5	19,5	19,7	28,7	31,1	24,1	36,2	44,9
	HSL-3-R / HSL-3-SKR <sup>a)</sup> HSL-3-GR		13,3	13,3	13,3	19,7	21,7	21,7	24,1	31,6	31,6
Shear $V_{Rd}$	HSL-3 / HSL-3-B	[kN]	24,9	24,9	24,9	39,4	48,4	48,4	48,2	71,7	71,7
	HSL-3-G		20,9	20,9	20,9	33,4	33,4	33,4	47,4	47,4	47,4
	HSL-3-SH / HSL-3-SK <sup>a)</sup>		24,9	-	-	39,4	-	-	48,2	-	-
	HSL-3-R, HSL-3-SKR <sup>a)</sup>		31,3	35,5	35,5	39,4	40,2	40,2	48,2	52,2	52,2
	HSL-3-GR		31,3	32,2	32,2	39,4	47,1	48,2	63,0	63,0	67,3
<b>Cracked concrete</b>											
Tension $N_{Rd}$	HSL-3 / HSL-3-B HSL-3-G HSL-3-SH / HSL-3-SK <sup>a)</sup>	[kN]	6,7	6,7	6,7	10,7	10,7	10,7	17,2	16,0	16,0
	HSL-3-R / HSL-3-SKR <sup>a)</sup> HSL-3-GR		8,0	8,0	8,0	10,7	10,7	10,7	17,2	16,0	16,0
Shear $V_{Rd}$	HSL-3 / HSL-3-B	[kN]	20,1	24,9	24,9	28,1	41,0	48,4	34,3	51,6	71,1
	HSL-3-G		20,1	20,9	20,9	28,1	33,4	33,4	34,3	47,4	47,4
	HSL-3-SH / HSL-3-SK <sup>a)</sup>		20,1	-	-	28,1	-	-	34,3	-	-
	HSL-3-R, HSL-3-SKR <sup>a)</sup>		22,3	34,3	35,5	28,2	40,2	40,2	34,4	51,6	52,2
	HSL-3-GR		22,3	32,2	32,2	28,1	41,0	47,1	34,3	51,6	63,0

Anchor size		M16			M20			M24			
<b>Non-cracked concrete</b>											
Tension $N_{Rd}$	HSL-3 / HSL-3-B HSL-3-G	[kN]	33,7	43,3	43,3	47,1	63,3	63,3	61,8	66,7	66,7
	HSL-3-R HSL-3-GR		33,7	43,3	43,3	47,1	63,3	63,3	-	-	-
Shear $V_{Rd}$	HSL-3 / HSL-3-B	[kN]	67,3	94,1	123,7	94,1	129,9	148,8	123,7	162,6	163,6
	HSL-3-G		67,3	94,1	96,5	94,1	124,2	124,2	123,7	162,6	163,6
	HSL-3-R		67,3	82,2	82,2	93,1	93,1	93,1	-	-	-
	HSL-3-GR		67,3	94,1	103,6	94,1	121,5	121,5	-	-	-
<b>Cracked concrete</b>											
Tension $N_{Rd}$	HSL-3 / HSL-3-B HSL-3-G	[kN]	24,0	24,0	24,0	33,5	33,3	33,3	44,1	43,3	43,3
	HSL-3-R HSL-3-GR		24,0	24,0	24,0	33,5	33,3	33,3	-	-	-
Shear $V_{Rd}$	HSL-3 / HSL-3-B	[kN]	48,0	67,1	88,2	67,1	92,6	120,8	88,2	115,9	146,1
	HSL-3-G		48,0	67,1	88,2	67,1	92,6	120,8	88,2	115,9	146,1
	HSL-3-R		48,0	67,1	82,2	67,1	92,6	93,1	-	-	-
	HSL-3-GR		48,0	67,1	88,2	67,1	92,6	120,8	-	-	-

a) HSL-3-SH, HSL-3-SK and HSL-3-SKR only available in sizes M8-M12

#### Effective anchorage depth <sup>a)</sup>

Anchor size		M8			M10			M12		
Eff. Anchorage depth	$h_{ef}$ [mm]	$h_{ef,1}^{b)}$	$h_{ef,2}$	$h_{ef,3}$	$h_{ef,1}^{b)}$	$h_{ef,2}$	$h_{ef,3}$	$h_{ef,1}^{b)}$	$h_{ef,2}$	$h_{ef,3}$
		60	80	100	70	90	110	80	105	130
Anchor size		M16			M20			M24		
Eff. Anchorage depth	$h_{ef}$ [mm]	$h_{ef,1}$	$h_{ef,2}$	$h_{ef,3}$	$h_{ef,1}$	$h_{ef,2}$	$h_{ef,3}$	$h_{ef,1}$	$h_{ef,2}$	$h_{ef,3}$
		100	125	150	125	155	185	150	180	210

a) HSL-3-SH, HSL-3-SK and HSL-3-SKR only available in sizes M8-M12

b) HSL-3-SH, HSL-3-SK and HSL-3-SKR can only be set in position 1.

#### Recommended loads <sup>b)</sup>

Anchor size		M8			M10			M12			
<b>Non-cracked concrete</b>											
Tension $N_{Rec}$	HSL-3 / HSL-3-B HSL-3-G	[kN]	9,3	14,0	14,0	14,1	20,5	22,2	17,2	25,9	32,1
	HSL-3-SH / HSL-3-SK <sup>a)</sup> HSL-3-R / HSL-3-SKR <sup>a)</sup> HSL-3-GR		9,5	9,5	9,5	14,1	15,5	15,5	17,2	22,5	22,5
48,1	HSL-3 / HSL-3-B	[kN]	17,8	17,8	17,8	28,2	34,6	34,6	34,4	51,2	51,2
	HSL-3-G		14,9	14,9	14,9	23,9	23,9	23,9	33,9	33,9	33,9
	HSL-3-SH / HSL-3-SK <sup>a)</sup>		17,8	-	-	28,2	-	-	34,4	-	-
	HSL-3-R, HSL-3-SKR <sup>a)</sup>		22,4	25,4	25,4	28,2	28,7	28,7	34,4	37,3	37,3
	HSL-3-GR		22,4	23,0	23,0	28,2	33,7	33,7	34,4	45,0	45,0
<b>Cracked concrete</b>											
Tension $N_{Rec}$	HSL-3 / HSL-3-B HSL-3-G	[kN]	4,8	4,8	4,8	7,6	7,6	7,6	12,3	11,4	11,4
	HSL-3-SH / HSL-3-SK <sup>a)</sup> HSL-3-R / HSL-3-SKR <sup>a)</sup> HSL-3-GR		5,7	5,7	5,7	7,6	7,6	7,6	12,3	11,4	11,4
Shear $V_{Rec}$	HSL-3 / HSL-3-B	[kN]	14,3	17,8	17,8	20,1	29,3	34,6	24,5	36,9	50,8
	HSL-3-G		14,3	14,9	14,9	20,1	23,9	23,9	24,5	33,9	33,9
	HSL-3-SH / HSL-3-SK <sup>a)</sup>		14,3	-	-	20,1	-	-	24,5	-	-
	HSL-3-R, HSL-3-SKR <sup>a)</sup>		15,9	24,5	25,4	20,1	28,7	28,7	24,5	36,9	37,3
	HSL-3-GR		15,9	23,0	23,0	20,1	29,3	33,7	24,5	36,9	45,0

Anchor size		M16			M20			M24			
<b>Non-cracked concrete</b>											
Tension $N_{Rec}$	HSL-3 / HSL-3-B HSL-3-G	[kN]	24,0	31,0	31,0	33,6	45,2	45,2	44,2	47,6	47,6
	HSL-3-R HSL-3-GR		24,0	31,0	31,0	33,6	45,2	45,2	-	-	-
Shear $V_{Rec}$	HSL-3 / HSL-3-B	[kN]	48,1	67,2	88,4	67,2	92,8	106,3	88,4	116,1	116,9
	HSL-3-G		48,1	67,2	68,9	67,2	88,7	88,7	88,4	116,1	116,9
	HSL-3-R		48,1	58,7	58,7	66,5	66,5	66,5	-	-	-
	HSL-3-GR		48,1	67,2	74,0	67,2	86,8	86,8	-	-	-
<b>Cracked concrete</b>											
Tension $N_{Rec}$	HSL-3 / HSL-3-B HSL-3-G	[kN]	17,1	17,1	17,1	24,0	23,8	23,8	31,5	31,0	31,0
	HSL-3-R HSL-3-GR		17,1	17,1	17,1	24,0	23,8	23,8	-	-	-
Shear $V_{Rec}$	HSL-3 / HSL-3-B	[kN]	34,3	47,9	63,0	47,9	66,2	86,3	63,0	82,8	104,3
	HSL-3-G		34,3	47,9	63,0	47,9	66,2	86,3	63,0	82,8	104,3
	HSL-3-R		34,3	47,9	58,7	47,9	66,2	66,5	-	-	-
	HSL-3-GR		34,3	47,9	63,0	47,9	66,2	86,3	-	-	-

a) HSL-3-SH, HSL-3-SK and HSL-3-SKR only available in sizes M8-M12.

b) With overall partial safety factor for action  $\gamma = 1,4$ . The partial safety factors for action depend on thy type of loading and shall be taken from national regulations.

### Seismic resistance (for a single anchor)

All data in this section applies to:

- Correct setting (See setting instruction)
- No edge distance and spacing influence
- Steel failure
- Minimum base material thickness
- Concrete C 20/25,  $f_{ck,cube}=25 \text{ N/mm}^2$
- $\alpha_{gap} = 0,5$
- Values for HSL-3-R, HSL-3-SKR and HSL-3-GR only applicable for hammer drilling

### Effective anchorage depth for seismic C2<sup>a)</sup>

Anchor size	M10			M12			M16			M20		
	$h_{ef,1}$	$h_{ef,2}$	$h_{ef,3}$	$h_{ef,1}$	$h_{ef,2}$	$h_{ef,3}$	$h_{ef,1}$	$h_{ef,2}$	$h_{ef,3}$	$h_{ef,1}$	$h_{ef,2}$	$h_{ef,3}$
Eff. Anchorage depth $h_{ef}$ [mm]	70	90	110	80	105	130	100	125	150	125	155	185

a) HSL-3-SH and HSL-3-SK can only be set in position 1 and only available in sizes M8-M12.

### Characteristic resistance in case of seismic category C2

Anchor size		M10			M12			M16			M20			
Tension $N_{Rk,seis}$	HSL-3 / HSL-3-B HSL-3-G	[kN]	12,2	12,2	12,2	21,9	25,8	25,8	30,6	34,2	34,2	40,1	40,1	40,1
	HSL-3-SH / HSL-3-SK		12,2	-	-	21,9	-	-	-	-	-	-	-	-
Shear $V_{Rk,seis}$	HSL-3 / HSL-3-B	[kN]	9,4	9,4	9,4	13,2	13,2	13,2	25,4	25,4	25,4	39,1	39,1	39,1
	HSL-3-G		9,0	9,0	9,0	11,3	11,3	11,3	22,3	22,3	22,3	25,1	25,1	25,1
	HSL-3-SH / HSL-3-SK		9,4	-	-	13,2	-	-	-	-	-	-	-	-

### Design resistance in case of seismic category C2

Anchor size		M10			M12			M16			M20			
Tension $N_{Rd,seis}$	HSL-3 / HSL-3-B HSL-3-G	[kN]	8,1	8,1	8,1	14,6	17,2	17,2	20,4	22,8	22,8	26,7	26,7	26,7
	HSL-3-SH / HSL-3-SK		8,1	-	-	14,6	-	-	-	-	-	-	-	-
Shear $V_{Rd,seis}$	HSL-3 / HSL-3-B	[kN]	7,5	7,5	7,5	10,5	10,5	10,5	20,3	20,3	20,3	31,2	31,2	31,2
	HSL-3-G		7,2	7,2	7,2	9,0	9,0	9,0	17,8	17,8	17,8	20,1	20,1	20,1
	HSL-3-SH / HSL-3-SK		7,5	-	-	10,5	-	-	-	-	-	-	-	-



**Effective anchorage depth for seismic C1 <sup>a)</sup>**

Anchor size			M8			M10			M12		
Eff. Anchorage depth	$h_{ef}$	[mm]	$h_{ef,1}^{b)}$	$h_{ef,2}$	$h_{ef,3}$	$h_{ef,1}^{b)}$	$h_{ef,2}$	$h_{ef,3}$	$h_{ef,1}^{b)}$	$h_{ef,2}$	$h_{ef,3}$
			60	80	100	70	90	110	80	105	130
Anchor size			M16			M20			M24		
Eff. Anchorage depth	$h_{ef}$	[mm]	$h_{ef,1}$	$h_{ef,2}$	$h_{ef,3}$	$h_{ef,1}$	$h_{ef,2}$	$h_{ef,3}$	$h_{ef,1}$	$h_{ef,2}$	$h_{ef,3}$
			100	125	150	125	155	185	150	180	210

a) HSL-3-SH, HSL-3-SK and HSL-3-SKR only available in sizes M8-M12

b) HSL-3-SH, HSL-3-SK and HSL-3-SKR can only be set in position 1.

**Characteristic resistance in case of seismic category C1**

Anchor size			M8			M10			M12		
Tension $N_{Rk,seis}$	HSL-3 / HSL-3-B HSL-3-G	[kN]	12,0	12,0	12,0	16,0	16,0	16,0	21,9	24,0	24,0
	HSL-3-SH / HSL-3-SK		12,0	-	-	16,0	-	-	21,9	-	-
	HSL-3-R / HSL-3-SKR		12,0	12,0	12,0	16,0	16,0	16,0	21,9	24,0	24,0
Shear $V_{Rk,seis}$	HSL-3 / HSL-3-B	[kN]	8,9	8,9	8,9	22,1	22,1	22,1	29,1	29,1	29,1
	HSL-3-G		7,5	7,5	7,5	15,3	15,3	15,3	19,3	19,3	19,3
	HSL-3-SH / HSL-3-SK <sup>a)</sup>		8,9	-	-	22,1	-	-	29,1	-	-
	HSL-3-R / HSL-3-SKR		5,2	5,2	5,2	12,9	12,9	12,9	14,0	14,0	14,0
Anchor size			M16			M20			M24		
Tension $N_{Rk,seis}$	HSL-3 / HSL-3-B HSL-3-G	[kN]	30,6	36,0	36,0	42,8	50,0	50,0	56,2	65,0	65,0
	HSL-3-R / HSL-3-SKR		30,6	36,0	36,0	42,8	50,0	50,0	56,2	65,0	65,0
	HSL-3 / HSL-3-B		57,1	57,1	57,1	54,9	54,9	54,9	81,8	81,8	81,8
Shear $V_{Rk,seis}$	HSL-3-G	[kN]	43,4	43,4	43,4	45,8	45,8	45,8	-	-	-
	HSL-3-R / HSL-3-SKR		29,6	29,6	29,6	29,6	29,6	29,6	-	-	-

**Design resistance in case of seismic category C1**

Anchor size			M8			M10			M12		
Tension $N_{Rd,seis}$	HSL-3 / HSL-3-B HSL-3-G	[kN]	6,7	6,7	6,7	10,7	10,7	10,7	14,6	16,0	16,0
	HSL-3-SH / HSL-3-SK		6,7	-	-	10,7	-	-	14,6	-	-
	HSL-3-R / HSL-3-SKR		8,0	8,0	8,0	10,7	10,7	10,7	14,6	16,0	16,0
Shear $V_{Rd,seis}$	HSL-3 / HSL-3-B	[kN]	7,1	7,1	7,1	17,7	17,7	17,7	23,3	23,3	23,3
	HSL-3-G		6,0	6,0	6,0	12,2	12,2	12,2	15,4	15,4	15,4
	HSL-3-SH / HSL-3-SK		7,1	-	-	17,7	-	-	23,3	-	-
	HSL-3-R / HSL-3-SKR		4,2	4,2	4,2	8,3	8,3	8,3	9,0	9,0	9,0
Anchor size			M16			M20			M24		
Tension $N_{Rd,seis}$	HSL-3 / HSL-3-B HSL-3-G	[kN]	20,4	24,0	24,0	28,5	33,3	33,3	37,5	43,3	43,3
	HSL-3-R / HSL-3-SKR		20,4	24,0	24,0	28,5	33,3	33,3	-	-	-
	HSL-3 / HSL-3-B		40,8	45,6	45,6	43,9	43,9	43,9	65,4	65,4	65,4
Shear $V_{Rk,seis}$	HSL-3-G	[kN]	34,7	34,7	34,7	36,6	36,6	36,6	-	-	-
	HSL-3-R / HSL-3-SKR		19,0	19,0	19,0	19,0	19,0	19,0	-	-	-



## Materials

### Mechanical properties

Anchor size		M8	M10	M12	M16	M20	M24
<b>HSL-3, HSL-3-G, HSL-3-B, HSL-3-SH, HSL-3-SK</b>							
Nominal tensile strength $f_{uk}$	[N/mm <sup>2</sup> ]	800	800	800	800	830	830
Yield strength $f_{yk}$	[N/mm <sup>2</sup> ]	640	640	640	640	640	640
Stressed cross-section $A_s$	[mm <sup>2</sup> ]	36,6	58,0	84,3	157	245	353
Moment of resistance $W$	[mm <sup>3</sup> ]	31,3	62,5	109,4	277,1	540,6	935,4
Design bending resistance without sleeve $M_{Rd,s}$	[Nm]	24,0	48,0	84,0	212,8	415,2	718,4
<b>HSL-3-R, HSL-3-GR, HSL-3-SKR</b>							
Nominal tensile strength $f_{uk}$	[N/mm <sup>2</sup> ]	700	700	700	700	700	-
Yield strength $f_{yk}$	HSL-3-R	560	450	450	450	450	-
	HSL-3-SKR						
	HSL-3-GR	560	560	560	560	560	-
Stressed cross-section $A_s$	[mm <sup>2</sup> ]	36,6	58,0	84,3	157	245	-
Moment of resistance $W$	[mm <sup>3</sup> ]	31,3	62,5	109,4	277,1	540,6	-
Design bending resistance without sleeve $M_{Rd,s}$	[Nm]	16,8	33,5	58,8	149,4	291,3	-

### Material quality

Part	Material
<b>Carbon Steel</b>	
HSL-3 Cone	Carbon steel, galvanized to $\geq 5 \mu\text{m}$
HSL-3-G Expansion sleeve	Carbon steel, galvanized to $\geq 5 \mu\text{m}$
HSL-3-B Collapsible element	POM Plastic element
HSL-3-SH Distance sleeve	Carbon steel, galvanized to $\geq 5 \mu\text{m}$
HSL-3 Washer	Carbon steel, galvanized to $\geq 5 \mu\text{m}$
HSL-3 Hexagonal bolt	Carbon steel, galvanized to $\geq 5 \mu\text{m}$ , rupture elongation $\geq 12\%$
HSL-3-G Hexagonal nut	Carbon steel, galvanized to $\geq 5 \mu\text{m}$
HSL-3-G Threaded rod	Carbon steel, galvanized to $\geq 5 \mu\text{m}$ , rupture elongation $\geq 12\%$
HSL-3-B Hexagonal bolt with safety cap	Carbon steel, galvanized to $\geq 5 \mu\text{m}$ , rupture elongation $\geq 12\%$
HSL-3-SH Hexagonal socket head screw	Carbon steel, galvanized to $\geq 5 \mu\text{m}$ , rupture elongation $\geq 12\%$
HSL-3-SK Countersunk bolt	Carbon steel, galvanized to $\geq 5 \mu\text{m}$ , rupture elongation $\geq 12\%$
HSL-3-SK Cup washer	Carbon steel, galvanized to $\geq 5 \mu\text{m}$
<b>Stainless Steel</b>	
HSL-3-R Cone	Stainless steel A4, coated
HSL-3-R Expansion sleeve	Stainless steel A4
HSL-3-GR Collapsible element	Plastic element
HSL-3-SKR Distance sleeve	Stainless steel A4
HSL-3-R Washer	Stainless steel A4, coated
HSL-3-R Hexagonal bolt	Stainless steel A4, coated, rupture elongation $\geq 12\%$
HSL-3-GR Hexagonal nut	Stainless steel A4, coated
HSL-3-GR Threaded rod	Stainless steel A4, coated, rupture elongation $\geq 12\%$
HSL-3-SKR Countersunk bolt	Stainless steel A4, coated, rupture elongation $\geq 12\%$
HSL-3-SKR Cup washer	Stainless steel A4, coated

**Anchor dimensions of HSL-3, HSL-3-G, HSL-3-B, HSL-3-B, HSL-3-SH, HSL-3-SK**

Anchor version	Thread size	t <sub>fix</sub> [mm]		d <sub>s</sub> [mm]	l <sub>1</sub> [mm]	l <sub>2</sub> [mm]	l <sub>3</sub> [mm]	l <sub>4</sub> [mm]		p [mm]
		min	max					min	max	
HSL-3	M8	5	200	11,9	12	32	15,2	19	214	2
HSL-3-G	M10	5	200	14,8	14	36	17,2	23	218	3
HSL-3	M12	5	200	17,6	17	40	20	28	223	3
HSL-3-G	M16	10	200	23,6	20	54,4	24,4	34,5	224,5	4
HSL-3-B	M20	10	200	27,6	20	57	31,5	51	241	4
HSL-3	M24	10	200	31,6	22	65	39	57	247	4
HSL-3-SH	M8	5		11,9	12	32	15,2	19		2
	M10	20		14,8	14	36	17,2	38		3
	M12	25		17,6	17	40	20	48		3
HSL-3-SK	M8	10	20	11,9	12	32	15,2	18,2	28,2	2
	M10	20		14,8	14	36	17,2	32,2		3
	M12	25		17,6	17	40	20	40		3

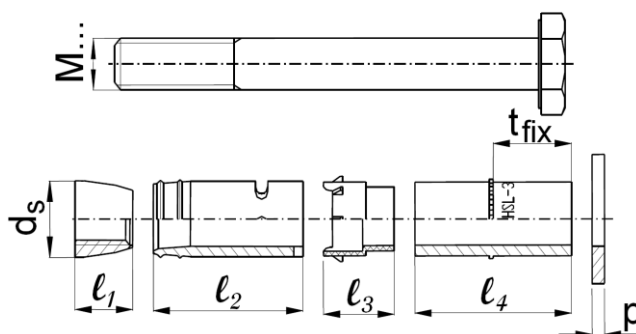

## Setting information

### Setting positions a)

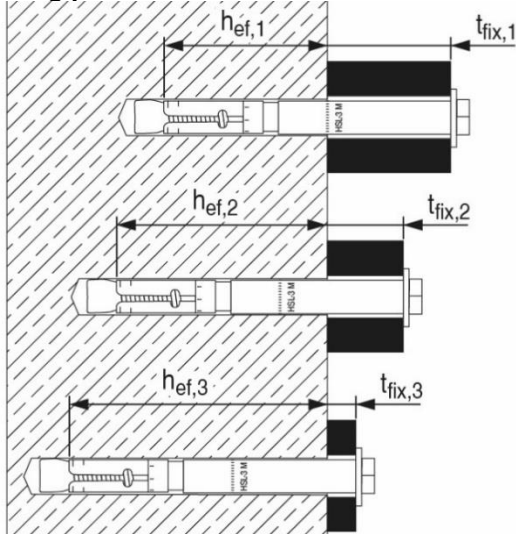

Setting position

①

Setting position

②

Setting position

③

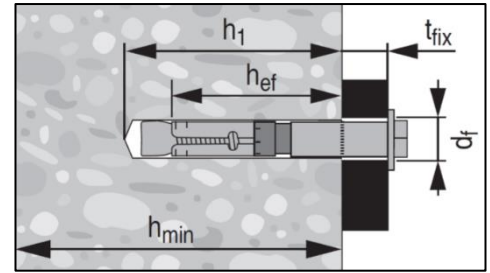

a) HSL-3-SH, HSL-3-SK and HSL-3-SKR can only be set in position 1.

### Setting details for HSL-3 / HSL-3-R

Anchor version		M8			M10			M12		
		①	②	③	①	②	③	①	②	③
Nominal diameter of drill bit	$d_0$ [mm]	12			15			18		
Max. cutting diameter of drill bit	$d_{cut}$ [mm]	12,5			15,5			18,5		
Max. diameter of clearance hole in the fixture	$d_f$ [mm]	14			17			20		
Setting position	$i$	①	②	③	①	②	③	①	②	③
Fixture thickness	$t_{fix,1}$ [mm]	5-200			5-200			5-200		
Effective fixture thickness	$t_{fix,i}$	$t_{fix,1}^{1)} - \Delta i$								
Reduction of fixture thickness	$\Delta i$ [mm]	0	20	40	0	20	40	0	25	50
Effective anchorage depth	$h_{ef,i}$ [mm]	60	80	100	70	90	110	80	105	130
Min. depth of drill hole	$h_{1,i}$ [mm]	80	100	120	90	110	130	105	130	155
Min. thickness of concrete member	$h_{min,i}$ [mm]	120	170	195	140	195	215	160	225	250
Width across flats	SW [mm]	13			17			19		
Installation torque (HSL-3-R)	$T_{inst}$ [Nm]	25			50 (35)			80		
Anchor version		M16			M20			M24 a)		
Nominal diameter of drill bit	$d_0$ [mm]	24			28			32		
Max. cutting diameter of drill bit	$d_{cut}$ [mm]	24,55			28,55			32,7		
Max. diameter of clearance hole in the fixture	$d_f$ [mm]	26			31			35		
Setting position	$i$	①	②	③	①	②	③	①	②	③
Fixture thickness	$t_{fix1}$ [mm]	10-200			10-200			10-200		
Effective fixture thickness	$t_{fix,i}$	$t_{fix,1}^{1)} - \Delta i$								
Reduction of fixture thickness	$\Delta i$ [mm]	0	25	50	0	30	60	0	30	60
Effective anchorage depth	$h_{ef,i}$ [mm]	100	125	150	125	155	185	150	180	210
Min. depth of drill hole	$h_{1,i}$ [mm]	125	150	175	155	185	215	180	210	240
Min. thickness of concrete member	$h_{min,i}$ [mm]	200	275	300	250	380	410	300	405	435
Width across flats	SW [mm]	24			30			36		
Installation torque	$T_{inst}$ [Nm]	120			200			250		

a) Anchor version M24 only available for HSL-3 carbon steel version.

**Setting details for HSL-3-G / HSL-3-GR**

Anchor version					M8			M10			M12		
Nominal diameter of drill bit	d <sub>0</sub>	[mm]	12			15			18				
Max. cutting diameter of drill bit	d <sub>cut</sub>	[mm]	12,5			15,5			18,5				
Max. diameter of clearance hole in the fixture	d <sub>f</sub>	[mm]	14			17			20				
Setting position	i		①	②	③	①	②	③	①	②	③		
Fixture thickness	t <sub>fix,1</sub>	[mm]	5-200			5-200			5-200				
Effective fixture thickness	t <sub>fix,i</sub>		t <sub>fix,1</sub> <sup>1)</sup> - Δi										
Reduction of fixture thickness	Δi	[mm]	0	20	40	0	20	40	0	25	50		
Effective anchorage depth	h <sub>ef,i</sub>	[mm]	60	80	100	70	90	110	80	105	130		
Min. depth of drill hole	h <sub>1,i</sub>	[mm]	80	100	120	90	110	130	105	130	155		
Min. thickness of concrete member	h <sub>min,i</sub>	[mm]	120	170	190 <sup>a)</sup> / 195	140	195	215	160	225	250		
Width across flats	SW	[mm]	13			17			19				
Installation torque	T <sub>inst</sub>	[Nm]	20 (30)			35 (50)			60 (80)				
Anchor version		M16			M20			M24 <sup>a)</sup>					
Nominal diameter of drill bit	d <sub>0</sub>	[mm]	24			28			32				
Max. cutting diameter of drill bit	d <sub>cut</sub>	[mm]	24,55			28,55			32,7				
Max. diameter of clearance hole in the fixture	d <sub>f</sub>	[mm]	26			31			35				
Setting position	i		①	②	③	①	②	③	①	②	③		
Fixture thickness	t <sub>fix1</sub>	[mm]	10-200			10-200			10-200				
Effective fixture thickness	t <sub>fix,i</sub>		t <sub>fix,1</sub> <sup>1)</sup> - Δi										
Reduction of fixture thickness	Δi	[mm]	0	25	50	0	30	60	0	30	60		
Effective anchorage depth	h <sub>ef,i</sub>	[mm]	100	125	150	125	155	185	150	180	210		
Min. depth of drill hole	h <sub>1,i</sub>	[mm]	125	150	175	155	185	215	180	210	240		
Min. thickness of concrete member	h <sub>min,i</sub>	[mm]	200	275	300	250	380	410	300	405	435		
Width across flats	SW	[mm]	24			30			36				
Installation torque	T <sub>inst</sub>	[Nm]	80 (120)			160 (200)			180				

a) Anchor version M24 only available for HSL-3-G carbon steel version.

**Setting details for HSL-3-B**

Anchor version					M12			M16			M20			M24		
Nominal diameter of drill bit	d <sub>0</sub>	[mm]	18			24			28			32				
Max. cutting diameter of drill bit	d <sub>cut</sub>	[mm]	18,5			24,55			28,55			32,7				
Max. diameter of clearance hole in the fixture	d <sub>f</sub>	[mm]	20			26			31			35				
Setting position	i		①	②	③	①	②	③	①	②	③	①	②	③		
Fixture thickness	t <sub>fix,1</sub>	[mm]	5 - 200			10 - 200			10 - 200			10 - 200				
Effective fixture thickness	t <sub>fix,i</sub>		t <sub>fix,1</sub> <sup>1)</sup> - Δi													
Reduction of fixture thickness	Δi	[mm]	0	25	50	0	25	50	0	30	60	0	30	60		
Effective anchorage depth	h <sub>ef,i</sub>	[mm]	80	105	130	100	125	150	125	155	185	150	180	210		
Min. depth of drill hole	h <sub>1,i</sub>	[mm]	105	130	155	125	150	175	155	185	215	180	210	240		
Min. thickness of concrete member	h <sub>min,i</sub>	[mm]	160	225	250	200	275	300	250	380	410	300	405	435		
Width across flats	SW	[mm]	24			30			36			41				
Installation torque	T <sub>inst</sub>	[Nm]	The torque moment is controlled by the safety cap													

**Setting details for HSL-3-SH<sup>a)</sup>**

Anchor version		M8	M10	M12
Nominal diameter of drill bit	$d_0$ [mm]	12	15	18
Max. cutting diameter of drill bit	$d_{cut}$ [mm]	12,5	15,5	18,5
Max. diameter of clearance hole in the fixture	$d_f$ [mm]	14	17	20
Fixture thickness	$t_{fix}$ [mm]	5	20	25
Effective anchorage depth	$h_{ef}$ [mm]	60	70	80
Min. depth of drill hole	$h_1$ [mm]	85	95	110
Min. thickness of concrete member	$h_{min}$ [mm]	120	140	160
Width across flats	SW [mm]	6	8	10
Installation torque	$T_{inst}$ [Nm]	25	35	60

a) HSL-3-SH, HSL-3-SK and HSL-3-SKR can only be set in position 1.

#### Setting details for HSL-3-SK / HSL-3-SKR <sup>a)</sup>

Anchor version		M8	M10	M12
Nominal diameter of drill bit	$d_0$ [mm]	12	15	18
Max. cutting diameter of drill bit	$d_{cut}$ [mm]	12,5	15,5	18,5
Max. diameter of clearance hole in the fixture	$d_f$ [mm]	14	17	20
Top diameter of countersunk head in the fixture	$d_h$ [mm]	22,5	25,5	32,9
Bottom diameter of countersunk head in the fixture	$d_h$ [mm]	11,4	14,4	17,4
Height of the countersunk head in the fixture	$h_{cs}$ [mm]	5,8	6,0	8,0
Fixture thickness	$t_{fix}$ [mm]	10 – 20	20	25
Effective anchorage depth	$h_{ef}$ [mm]	60	70	80
Min. depth of drill hole	$h_1$ [mm]	80	90	105
Min. thickness of concrete member	$h_{min}$ [mm]	120	140	160
Width across flats	SW [mm]	5	6	8
Installation torque	$T_{inst}$ [Nm]	25 (18)	50	80

a) HSL-3-SH, HSL-3-SK and HSL-3-SKR can only be set in position 1.

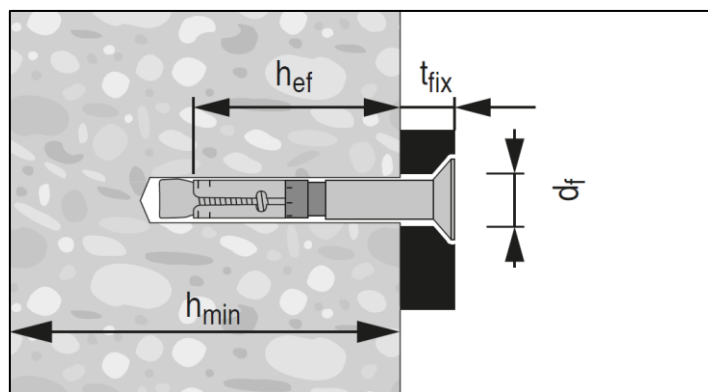

### Installation equipment

Anchor size	M8	M10	M12	M16	M20	M24
Rotary hammer	TE 2 – TE 30			TE 40 – TE 80		
Diamond coring <sup>1)</sup>	DD 30-W + SPX-T				DD 30-W + SPX-T DD 120 + DD-BI	
Other tools	blow out pump, hammer, torque wrench <sup>2)</sup>					

1) Diamond coring not available for HSL-3-R, HSL-3-GR and HSL-3-SKR anchors.

2) HSL-3-B only requires a regular wrench as it automatically ensures correct torque is applied.

### Setting parameters for HSL-3, HSL-3-G, HSL-3-B, HSL-3-SH, HSL-3-SK

Anchor size		M8			M10			M12		
Setting position	i	①	②	③	①	②	③	①	②	③
Minimum base material thickness	$h_{min}$ [mm]	120	170	190	140	195	215	160	225	250
Minimum spacing	$s_{min}$ [mm]	60			70			80		
	for $c \geq$ [mm]	100			100			160		
Minimum edge distance	$c_{min}$ [mm]	60			70			80		
	for $s \geq$ [mm]	100			160			240		
Anchor size		M16			M20			M24		
Setting position	i	①	②	③	①	②	③	①	②	③
Minimum base material thickness	$h_{min}$ [mm]	200	275	300	250	380	410	300	405	435
Minimum spacing	$s_{min}$ [mm]	100			125			150		
	for $c \geq$ [mm]	240			300			300		
Minimum edge distance	$c_{min}$ [mm]	100			150			150		
	for $s \geq$ [mm]	240			300			300		

### Setting parameters for HSL-3-R, HSL-3-GR, HSL-3-SKR

Anchor size		M8			M10			M12			M14			M20		
Setting position	i	①	②	③	①	②	③	①	②	③	①	②	③	①	②	③
Minimum base material thickness	$h_{min}$ [mm]	120	170	195	140	195	215	160	225	250	200	275	300	250	380	410
<b>Non-cracked concrete</b>																
Minimum spacing	$s_{min}$ [mm]	70			70			80			100			125		
	for $c \geq$ [mm]	100			100			160			240			300		
Minimum edge distance	$c_{min}$ [mm]	70			80			80			100			150		
	for $s \geq$ [mm]	140			160			240			240			300		
<b>Cracked concrete</b>																
Minimum spacing	$s_{min}$ [mm]	70			70			80			100			125		
	for $c \geq$ [mm]	100			100			170			240			300		
Minimum edge distance	$c_{min}$ [mm]	70			120			80			100			150		
	for $s \geq$ [mm]	140			160			240			240			300		

## Setting instructions

\*For detailed information on installation of each specific HSL-3 versions see instruction for use given with the package of the product.

Setting instruction	
<b>Hammer drilling</b>	
<b>1. Drilling</b> 	<b>2. Cleaning</b> 
<b>3. Installation</b> 	<b>4. Applying tightening torque</b> 
<b>Diamond drilling for HSL-3, HSL-3-B, HSL-3-G, HSL-3-SK, HSL-3-SH</b>	
<b>1. Drilling</b> 	<b>2. Cleaning</b> 
<b>3. Installation</b> 	<b>4. Applying tightening torque</b> 



**HSL-3-B Safety cap**

**Hammer drilling**

**1. Drilling**

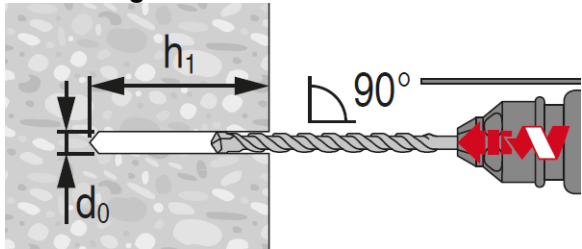

**2. Cleaning**

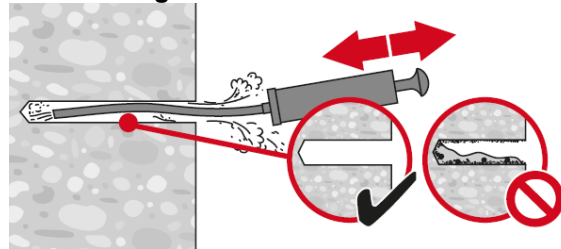

**3. Installation**

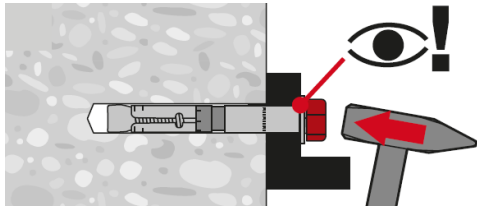

**4. Applying torque**

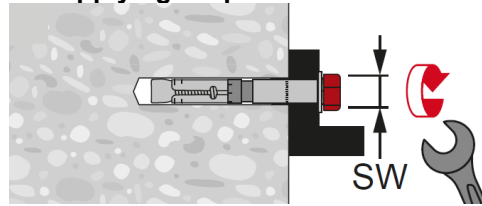

**5. Throw safety cap away**

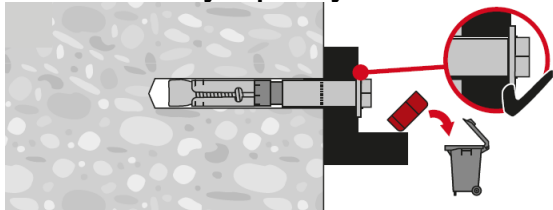

**Diamond drilling**

**1. Drilling**

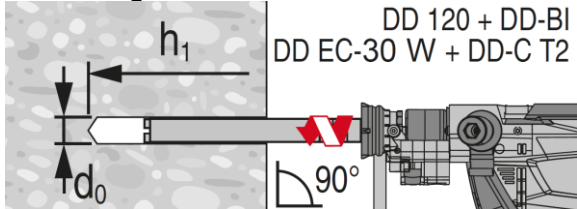

**2. Cleaning**

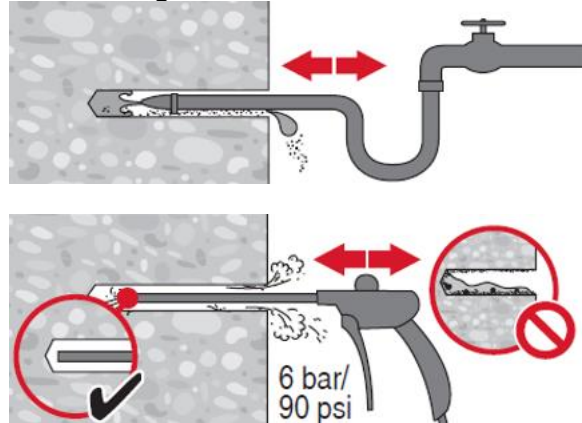

**3. Installation**

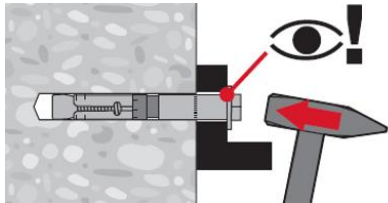

**4. Applying tightening torque**

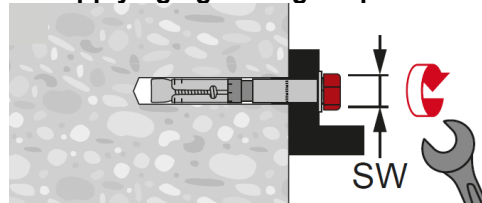

**5. Throw the safety cap away**

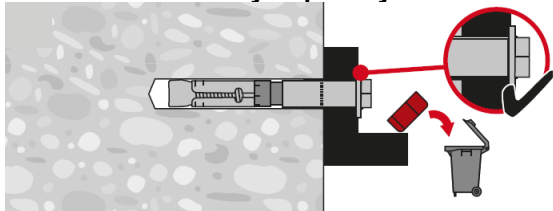

# HST3 Expansion anchor



Ultimate-performance expansion anchor for cracked concrete and seismic









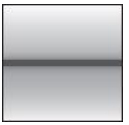

Chemical anchors

Mechanical anchors Expansion

Plastic/Light duty metal anchors

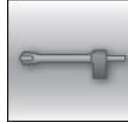
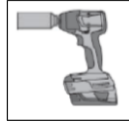
Insulation anchors

Anchor version	Benefits
 <p>HST3 HST3-R (M8-M24)</p>	<ul style="list-style-type: none"> <li>- Highest resistance for reduced member thickness, short spacing and edge distances</li> <li>- Increased undercut percentage in combination with optimized coating</li> <li>- Suitable for non-cracked and cracked concrete C 12/15 to C 80/95</li> <li>- Highly reliable and safe anchor for structural seismic design with ETA C1/C2 approval</li> <li>- Flexibility with two embedment depths included in the ETA</li> <li>- Minimum edge and spacing distances reduced by up to 25% compared to HST</li> <li>- Design tension resistance increased by up to 66% compared to HST</li> <li>- Product and length identification mark facilitates quality control and inspection</li> </ul>
 <p>HST3-BW HST3-R-BW (M8-M24)</p>	

Base material	Load conditions
 <p>Concrete (non-cracked)</p>  <p>Concrete (cracked)</p>	 <p>Static/ quasi-static</p>  <p>Seismic ETA-C1/C2</p>  <p>Fire resistance</p>
Installation conditions	Other information
 <p>Hammer drilled holes</p>  <p>Diamond drilled holes</p>  <p>Hollow drill-bit drilling</p>  <p>Impact wrench with adaptative torque module</p>	 <p>European Technical Assessment</p>  <p>CE conformity</p>  <p>PROFIS Anchor design Software</p>  <p>FM approved</p>

**Approvals / certificates**

Description	Authority / Laboratory	No. / date of issue
European technical assessment <sup>a)</sup>	DIBt, Berlin	ETA-98/0001 / 2018-02-09
Fire test report	DIBt, Berlin	ETA-98/0001 / 2018-02-09
Shock approval	FOCP, Zurich	BZS D 08-602 / 2016-08-17

a) All data given in this section according to ETA-98/0001, issue 2017-20-07.

## Static and quasi-static loading (for a single anchor)

### All data in this section applies to:

- Correct setting (See setting instruction)
- No edge distance and spacing influence
- Steel failure
- Minimum base material thickness
- Concrete C 20/25,  $f_{ck,cube} = 25 \text{ N/mm}^2$

### Effective anchorage depth for static

Anchor size		M8	M10		M12		M16		M20	M24
Eff. Anchorage depth	$h_{ef}$ [mm]	47	40	60	50	70	65	85	101	125

### Characteristic resistance

Anchor size		M8	M10		M12		M16		M20	M24	
<b>Non-cracked concrete</b>											
Tension $N_{Rk}$	HST3/HST3-BW	[kN]	12,0	12,8	22,0	17,9	25,0	26,5	39,6	51,3	60,0
	HST3-R/HST3-R-BW		12,0	12,8	22,0	17,9	25,0	26,5	39,6	51,3	60,0
Shear $V_{Rk}$	HST3/HST3-BW	[kN]	13,8	21,9	23,6	34,0	35,4	54,5	55,3	83,9	94,0
	HST3-R/HST3-R-BW		15,7	25,6	25,3	31,1	36,7	48,6	63,6	97,2	115,0
<b>Cracked concrete</b>											
Tension $N_{Rk}$	HST3/HST3-BW	[kN]	8,0	9,1	15,0	12,7	20,0	18,9	28,2	36,5	40,0
	HST3-R/HST3-R-BW		8,5	9,1	15,0	12,7	20,0	18,9	28,2	36,5	40,0
Shear $V_{Rk}$	HST3/HST3-BW	[kN]	13,8	21,9	23,6	34,0	35,4	54,5	55,3	83,9	94,0
	HST3-R/HST3-R-BW		15,7	24,3	25,3	31,1	36,7	48,6	63,6	97,2	115,0

### Design resistance

Anchor size		M8	M10		M12		M16		M20	M24	
<b>Non-cracked concrete</b>											
Tension $N_{Rd}$	HST3/HST3-BW	[kN]	8,0	8,5	14,7	11,9	16,7	17,6	26,4	34,2	40,0
	HST3-R/HST3-R-BW		8,0	8,5	14,7	11,9	16,7	17,6	26,4	34,2	40,0
Shear $V_{Rd}$	HST3/HST3-BW	[kN]	11,0	17,5	18,9	27,2	28,3	43,6	44,2	67,1	62,7
	HST3-R/HST3-R-BW		12,6	20,5	20,2	24,9	29,4	38,9	50,9	77,8	88,5
<b>Cracked concrete</b>											
Tension $N_{Rd}$	HST3/HST3-BW	[kN]	5,3	6,1	10,0	8,5	13,3	12,6	18,8	24,4	26,7
	HST3-R/HST3-R-BW		5,7	6,1	10,0	8,5	13,3	12,6	18,8	24,4	26,7
Shear $V_{Rd}$	HST3/HST3-BW	[kN]	11,0	16,2	18,9	23,6	28,3	42,9	44,2	67,1	62,7
	HST3-R/HST3-R-BW		12,6	16,2	20,2	23,6	29,4	38,9	50,9	77,8	83,9

### Recommended loads<sup>a)</sup>

Anchor size		M8	M10	M12	M16	M20	M24				
<b>Non-cracked concrete</b>											
Tension $N_{Rec}$	HST3/HST3-BW	[kN]	5,7	6,1	10,5	8,5	11,9	12,6	18,8	24,4	28,6
	HST3-R/HST3-R-BW		5,7	6,1	10,5	8,5	11,9	12,6	18,8	24,4	28,6
Shear $V_{Rec}$	HST3/HST3-BW	[kN]	7,9	12,5	13,5	19,4	20,2	31,1	31,6	47,9	44,8
	HST3-R/HST3-R-BW		9,0	14,6	14,5	17,8	21,0	27,8	36,3	55,5	63,2
<b>Cracked concrete</b>											
Tension $N_{Rec}$	HST3/HST3-BW	[kN]	3,8	4,3	7,1	6,1	9,5	9,0	13,4	17,4	19,0
	HST3-R/HST3-R-BW		4,0	4,3	7,1	6,1	9,5	9,0	13,4	17,4	19,0
Shear $V_{Rec}$	HST3/HST3-BW	[kN]	7,9	11,6	13,5	16,8	20,2	30,6	31,6	47,9	44,8
	HST3-R/HST3-R-BW		9,0	11,6	14,5	16,8	21,0	27,8	36,3	55,5	59,9

a) With overall partial safety factor for action  $\gamma = 1,4$ , The partial safety factors for action depend on the type of loading and shall be taken from national regulations,

### Seismic loading (for a single anchor)

#### All data in this section applies to:

- Correct setting (See setting instruction)
- No edge distance and spacing influence
- Steel failure
- Minimum base material thickness
- Concrete C 20/25,  $f_{ck,cube} = 25 \text{ N/mm}^2$
- $\alpha_{gap} = 1,0$  (using Hilti seismic filling set)

#### Effective anchorage depth for seismic C2 and C1

Anchor size	M8	M10	M12	M16	M20	M24
Eff, Anchorage depth $h_{ef}$ [mm]	47	60	70	85	101	-

#### Characteristic resistance in case of seismic performance C2

Anchor size	M8	M10	M12	M16	M20	M24		
Tension $N_{Rk,seis}$	HST3 / HST3-BW	[kN]	3,0	10,4	17,9	24,0	31,1	-
	HST3-R / HST3-R-BW		3,4	10,4	17,9	24,0	31,1	-
Shear $V_{Rk,seis}$	HST3 / HST3-BW	[kN]	9,9	19,0	28,6	48,5	84,3	-
	HST3-R / HST3-R-BW		9,9	17,2	27,6	42,5	67,4	-

#### Design resistance in case of seismic performance C2

Anchor size	M8	M10	M12	M16	M20	M24		
Tension $N_{Rd,seis}$	HST3 / HST3-BW	[kN]	2,0	6,9	11,9	16,0	20,7	-
	HST3-R / HST3-R-BW		2,3	6,9	11,9	16,0	20,7	-
Shear $V_{Rd,seis}$	HST3 / HST3-BW	[kN]	7,9	15,2	22,9	38,8	66,3	-
	HST3-R / HST3-R-BW		7,9	13,8	22,1	34,0	53,9	-

#### Characteristic resistance in case of seismic performance C1

Anchor size	M8	M10	M12	M16	M20	M24		
Tension $N_{Rk,seis}$	HST3 / HST3-BW	[kN]	7,5	12,0	17,9	24,0	31,1	-
	HST3-R / HST3-R-BW		7,5	12,0	17,9	24,0	31,1	-
Shear $V_{Rk,seis}$	HST3 / HST3-BW	[kN]	16,6	25,8	39,0	60,9	99,4	-
	HST3-R / HST3-R-BW		19,5	28,4	44,3	70,2	99,4	-

### Design resistance in case of seismic performance C1

Anchor size		M8	M10	M12	M16	M20	M24
Tension $N_{Rd,seis}$	HST3 / HST3-BW [kN]	5,0	8,0	11,9	16,0	20,7	-
	HST3-R / HST3-R-BW [kN]	5,0	8,0	11,9	16,0	20,7	-
Shear $V_{Rd,seis}$	HST3 / HST3-BW [kN]	13,3	20,6	31,2	48,7	66,3	-
	HST3-R / HST3-R-BW [kN]	15,6	22,7	33,2	54,5	66,3	-

### Fire resistance

#### All data in this section applies to:

- Correct setting (See setting instruction)
- No edge distance and spacing influence
- *Steel* failure
- Minimum base material thickness
- Concrete C 20/25,  $f_{ck,cube} = 25 \text{ N/mm}^2$
- Hilti technical data for concrete strength class C55/67 to C80/95: for a structural element that fulfills the requirements according to DIN EN 1992-1-2 the fire resistance of C20/25 could be assumed.
- partial safety factor for resistance under fire exposure  $\gamma_{M,fi}=1,0$  (in absence of other national regulations)

#### Effective anchorage depth for static

Anchor size		M8	M10		M12		M16		M20	M24
Eff. Anchorage depth	$h_{ef}$ [mm]	47	40	60	50	70	65	85	101	125

#### Characteristic resistance

Anchor size		M8	M10		M12		M16		M20	M24
<b>Fire Exposure R30</b>										
Tension $N_{Rk,fi}$	HST3/HST3-BW [kN]	0,9	1,5	2,4	2,3	5,0	4,4	7,1	9,1	12,6
	HST3-R/HST3-R-BW [kN]	1,9	1,8	3,0	3,2	5,0	4,7	7,1	9,1	12,6
Shear $V_{Rk,fi}$	HST3/HST3-BW [kN]	0,9	1,5	2,4	2,3	5,2	4,4	9,7	15,2	21,9
	HST3-R/HST3-R-BW [kN]	4,9	4,7	11,8	8,9	17,1	16,9	31,9	37,0	62,8
<b>Fire Exposure R120</b>										
Tension $N_{Rk,fi}$	HST3/HST3-BW [kN]	0,6	0,8	0,9	0,8	1,3	1,5	2,4	3,8	5,4
	HST3-R/HST3-R-BW [kN]	1,5	1,5	2,4	2,5	4,0	3,8	5,6	7,3	10,1
Shear $V_{Rk,fi}$	HST3/HST3-BW [kN]	0,6	0,8	0,9	0,8	1,5	1,5	2,4	3,8	5,4
	HST3-R/HST3-R-BW [kN]	1,7	2,0	3,3	3,3	4,8	6,2	9,0	14,1	20,3

#### Design resistance

Anchor size		M8	M10		M12		M16		M20	M24
<b>Fire Exposure R30</b>										
Tension $N_{Rd,fi}$	HST3/HST3-BW [kN]	0,9	1,5	2,4	2,3	5,0	4,4	7,1	9,1	12,6
	HST3-R/HST3-R-BW [kN]	1,9	1,8	3,0	3,2	5,0	4,7	7,1	9,1	12,6
Shear $V_{Rd,fi}$	HST3/HST3-BW [kN]	0,9	1,5	2,4	2,3	5,2	4,4	9,7	15,2	21,9
	HST3-R/HST3-R-BW [kN]	4,9	4,7	11,8	8,9	17,1	16,9	31,9	37,0	62,8
<b>Fire Exposure R120</b>										
Tension $N_{Rd,fi}$	HST3/HST3-BW [kN]	0,6	0,8	0,9	0,8	1,3	1,5	2,4	3,8	5,4
	HST3-R/HST3-R-BW [kN]	1,5	1,5	2,4	2,5	4,0	3,8	5,6	7,3	10,1
Shear $V_{Rd,fi}$	HST3/HST3-BW [kN]	0,6	0,8	0,9	0,8	1,5	1,5	2,4	3,8	5,4
	HST3-R/HST3-R-BW [kN]	1,7	2,0	3,3	3,3	4,8	6,2	9,0	14,1	20,3

## Materials

### Mechanical properties

Anchor size		M8	M10	M12	M16	M20	M24
Nominal tensile strength $f_{uk,thread}$	HST3/HST3-BW	800	800	800	720	700	530
	HST3-R/HST3-R-BW	720	710	710	650	650	650
Yield strength $f_{yk,thread}$	HST3/HST3-BW	640	640	640	576	560	450
	HST3-R/HST3-R-BW	576	568	568	520	520	500
Stressed cross-section $A_s$		36,6	58,0	84,3	157	245	353
Moment of resistance $W$		31,2	62,3	109	277	541	935
Char, bending resistance $M^{0_{Rk,s}}$	HST3/HST3-BW	30	60	105	240	457	595
	HST3-R/HST3-R-BW	27	53	93	216	425	730

### Material quality

Part	Material
Expansion sleeve	HST3/HST3-BW
	HST3-R/HST3-R-BW
Bolt	HST3/HST3-BW
	HST3-R/HST3-R-BW
Washer	HST3/HST3-BW
	HST3-R/HST3-R-BW
Hexagon nut	HST3/HST3-BW
	HST3-R/HST3-R-BW

### Anchor dimensions of HST3, HST3-BW, HST3-R, HST3-R-BW

Anchor size	M8	M10	M12	M16	M20	M24
Maximum length of anchor $l_{max} \leq$	260	280	350	475	450	500
Shaft diameter at the cone $d_R$	5,60	6,94	8,22	11,00	14,62	17,4
Length of expansion sleeve $l_s$	13,6	16,0	20,0	25,0	28,3	36,0
Diameter of washer $d_w \geq$	15,57	19,48	23,48	29,48	36,38	43,38

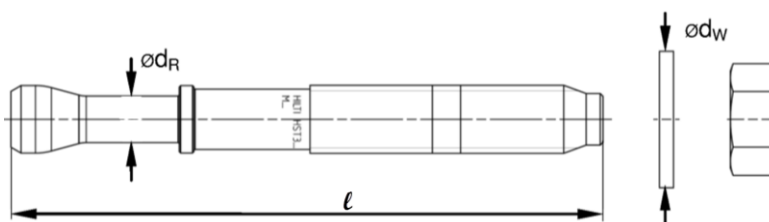

## Setting information

### Setting details

Anchor size		M8	M10	M12	M16	M20	M24
Nominal diameter of drill bit	$d_o$ [mm]	8	10	12	16	20	24
Cutting diameter of drill bit	$d_{cut} \leq$ [mm]	8,45	10,45	12,5	16,5	20,55	24,55
Effective embedment depth	$h_{ef,1}$ [mm]	-	40	50	65	-	-
	$h_{ef,2}$ [mm]	47	60	70	82	101	125
Drill hole depth <sup>1)</sup>	$h_{1,1} \geq$ [mm]	-	53	68	86	-	-
	$h_{1,2} \geq$	59	73	88	106	124	151
Thread engagement length	$h_{nom,1}$ [mm]	-	48	60	78	-	-
	$h_{nom,2}$ [mm]	54	68	80	98	116	143
Maximum diameter of clearance hole in the fixture	$d_f$ [mm]	9	12	14	18	22	26
Torque moment	$T_{inst}$ [Nm]	20	45	60	110	180	300
Maximum thickness of fixture	$t_{fix,max}$ [mm]	195	220	270	370	310	330
Width across	SW [mm]	13	17	19	24	30	36

1) In case of diamond drilling +5 mm for M8 to M10 and +2 mm for M12 to M24.

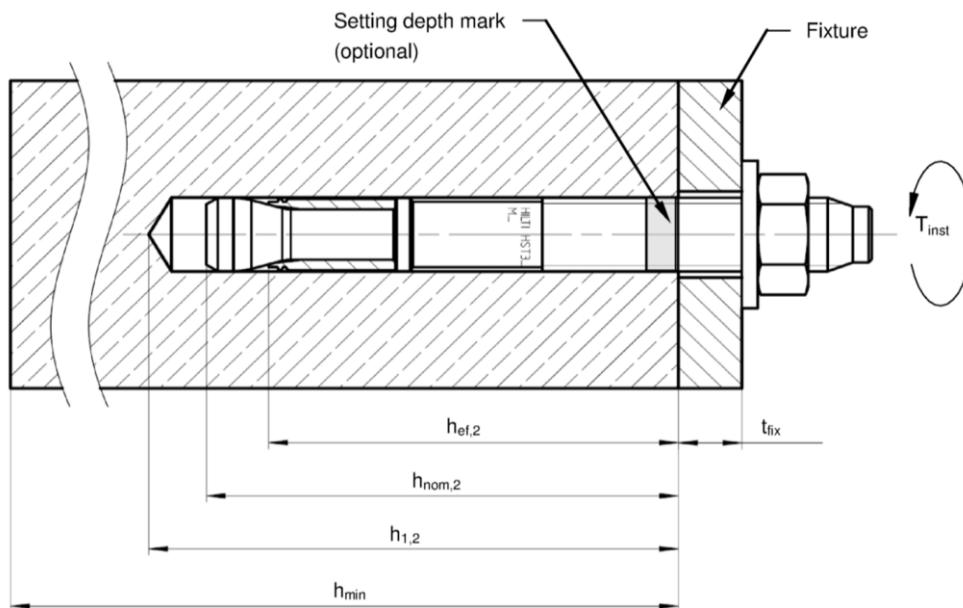

### Installation equipment

Anchor size	M8	M10	M12	M16	M20	M24
Rotary hammer	TE2(-A) – TE30(-A)				TE40 – TE80	
Diamond coring tool	DD-30W, DD-EC1					
Setting tool	Hilti S7W 6AT 22A – SI-AT-A22			-		
Hollow drill bit	-		TE-CD, TE-YD			
Other tools	hammer, torque wrench, blow out pump					



**Setting parameters of HST3 / HST3-R for M8 and M10**

Anchor Size			M8			M10			
Concrete class			C20/25 to C50/60 <sup>a)</sup> C55/67 to C80/95 <sup>b)</sup>	C12/15 <sup>b)</sup> C16/20 <sup>b)</sup>	C12/15 to C16/20 <sup>a)</sup>	C20/25 to C50/60 <sup>a)</sup> C55/67 to C80/95 <sup>b)</sup>	C12/15 <sup>b)</sup> C16/20 <sup>b)</sup>		
Effective anchorage depth	$h_{ef}$	[mm]	47		47	40	60		60
Minimum base material thickness	$h_{min}$	[mm]	80	100	100	80	100	120	120
Minimum spacing in <i>non-cracked</i> concrete	$s_{min}$	[mm]	35	35	35	50	40	40	70
	for $c \geq$	[mm]	55	50	65	95	100	60	90
Minimum spacing in <i>cracked</i> concrete	$s_{min}$	[mm]	35	35	35	40	40	40	45
	for $c \geq$	[mm]	50	50	55	90	100	55	85
Minimum edge distance in <i>non-cracked</i> concrete	$c_{min}$	[mm]	40	40	50	50	60	50	80
	for $s \geq$	[mm]	50	50	80	190	90	90	120
Minimum edge distance in <i>cracked</i> concrete	$c_{min}$	[mm]	40	40	40	45	60	45	70
	for $s \geq$	[mm]	50	50	75	180	90	80	120
Critical spacing for splitting failure and concrete cone failure	$s_{cr,sp}$	[mm]	141		188	168	180		240
	$s_{cr,N}$	[mm]	141		141	120	180		180
Critical edge distance for splitting failure and concrete cone failure	$c_{cr,sp}$	[mm]	71		94	84	90		120
	$c_{cr,N}$	[mm]	71		71	60	90		90

**Setting parameters of HST3 / HST3-R for M12 and M16**

Anchor Size			M12			M16			
Concrete class			C20/25 to C50/60 <sup>a)</sup>	C20/25 to C50/60 <sup>a)</sup> C55/67 to C80/95 <sup>b)</sup>	C12/15 <sup>b)</sup> C16/20 <sup>b)</sup>	C20/25 to C50/20 <sup>a)</sup>	C20/25 to C50/60 <sup>a)</sup> C55/67 to C80/95 <sup>b)</sup>	C12/15 <sup>b)</sup> C16/20 <sup>b)</sup>	
Effective anchorage	$h_{ef}$	[mm]	50	70		70	65	85	
Minimum base material	$h_{min}$	[mm]	100	120	140	140	120	140	160
Minimum spacing in <i>non-cracked</i> concrete	$s_{min}$	[mm]	55	50	60	110	75	80	65
	for $c$	[mm]	110	100	70	140	140	130	95
Minimum spacing in <i>cracked</i> concrete	$s_{min}$	[mm]	50	50	50	80	65	80	65
	for $c \geq$	[mm]	105	90	70	120	130	130	95
Minimum edge distance in <i>non-cracked</i> concrete	$c_{min}$	[mm]	60	60	55	90	65	65	65
	for $s \geq$	[mm]	210	120	110	190	240	180	150
Minimum edge distance in <i>cracked</i> concrete	$c_{min}$	[mm]	55	60	55	80	65	65	65
	for $s \geq$	[mm]	210	120	110	170	240	180	150
Critical spacing for splitting failure and concrete cone failure	$s_{cr,sp}$	[mm]	180	210		280	208	255	
	$s_{cr,N}$	[mm]	150	210		210	195	255	
Critical edge distance for splitting failure and concrete cone failure	$c_{cr,sp}$	[mm]	90	105		140	104	128	
	$c_{cr,N}$	[mm]	75	105		105	98	128	

**Setting parameters of HST3(-BW) / HST3-R(-BW) for M20 and M24**

Anchor Size		M20			M24		
Concrete class		C20/25 to C50/60 <sup>a)</sup> C55/67 to C80/95 <sup>b)</sup>		C12/15 <sup>b)</sup> C16/20 <sup>b)</sup>	C20/25 to C50/60 <sup>a)</sup> C55/67 to C80/95 <sup>b)</sup>	C12/15 <sup>b)</sup> C16/20 <sup>b)</sup>	
Effective anchorage	$h_{ef}$ [mm]	101		101	125	125	
Minimum base material	$h_{min}$ [mm]	160	200	200	250	250	
Minimum spacing in <i>non-cracked</i> concrete	HST3	$s_{min}$ [mm]	120	90	90	125	180
	HST3-BW	for $c \geq$ [mm]	180	130	165	255	375
Minimum spacing in <i>cracked</i> concrete	HST3-R	$s_{min}$ [mm]	120	90	90	125	180
	HST3-R-BW	for $c \geq$ [mm]	180	130	165	205	375
Min. edge distance in <i>non-cracked</i> concrete	HST3	$c_{min}$ [mm]	120	80	90	170	260
	HST3-BW	for $s \geq$ [mm]	180	180	140	295	400
Min. edge distance in <i>cracked</i> concrete	HST3-R	$c_{min}$ [mm]	120	80	120	150	260
	HST3-R-BW	for $s \geq$ [mm]	180	180	270	235	400
Critical spacing for splitting failure and concrete cone failure	HST3	$s_{cr,sp}$ [mm]	384		404	375	500
	HST3-BW	$s_{cr,N}$ [mm]	303		303	375	375
Critical spacing for splitting failure and concrete cone failure	HST3-R	$s_{cr,sp}$ [mm]	192		202	188	250
	HST3-R-BW	$s_{cr,N}$ [mm]	152		152	188	188

a) Data covered by ETA-98/0001 issue 2017-20-07.

b) Data covered by Hilti Technical Data

For spacing (edge distance) smaller than critical spacing (critical edge distance) the design loads have to be reduced.

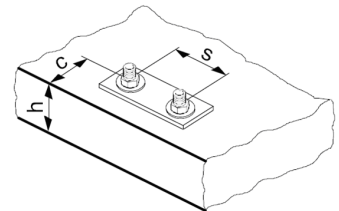

## Setting instructions

\*For detailed information on installation see instruction for use given with the package of the product

### Setting instruction for HST3, HST3-BW, HST3-R, HST3-R-BW

#### Hammer drilling (M8, M10, M12, M16, M20, M24)

##### 1. Drill the hole

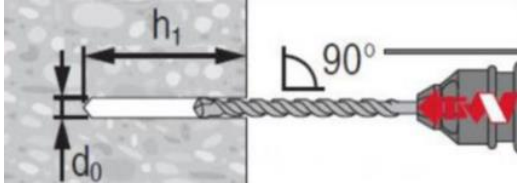

##### 2. Clean the hole

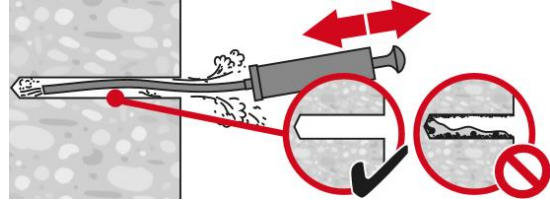

##### 3a. Insert the anchor with hammer

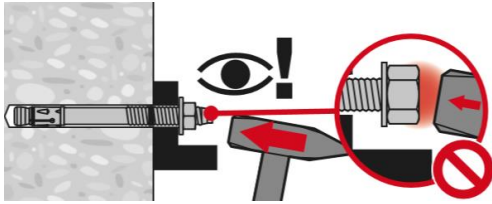

##### 3a. Insert the anchor with setting tool HS-SC

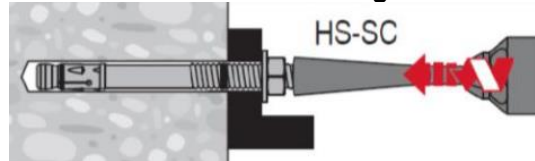

##### 4. Check

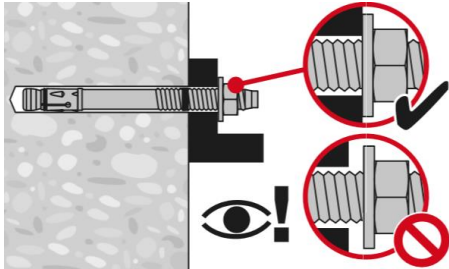

##### 5a. Torque with calibrated torque wrench (M8-M24)

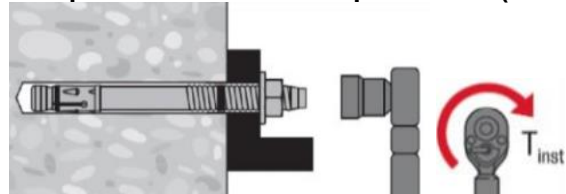

##### 5b. Torque with impact wrench with Adaptive torque module (M8-M12)

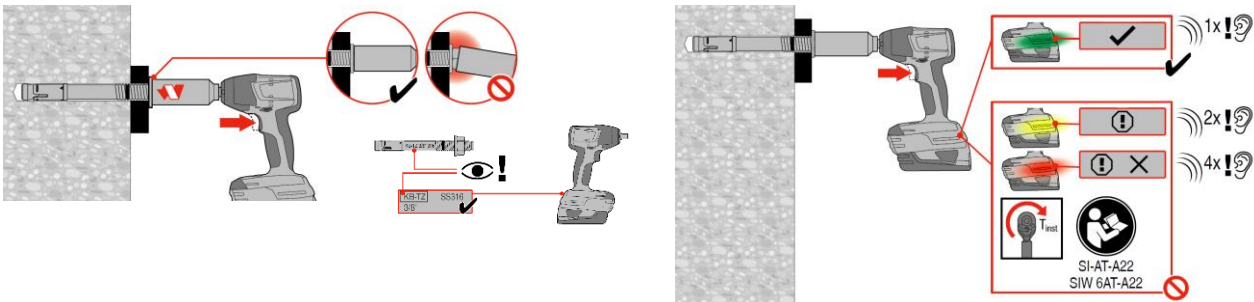

#### Hollow Drill Bit (M16, M20, M24), no cleaning required

##### 1. Drill the hole with the Hollow drill bit

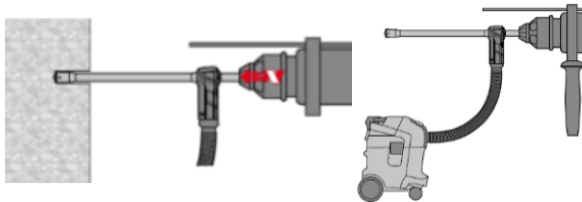

##### 2a. Insert the anchor with hammer

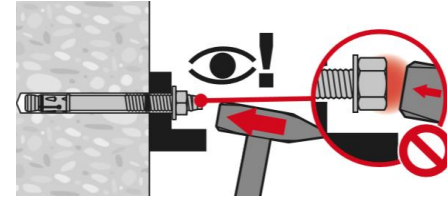

##### 2b. Insert the anchor with setting tool HS-SC

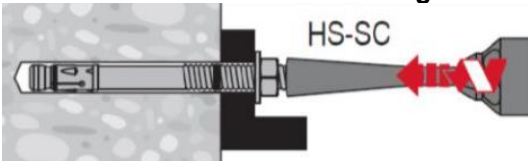

##### 3. Check

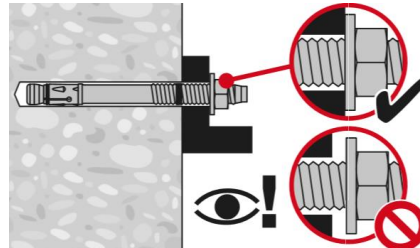

**5a. Torque with calibrated torque wrench (M8-M24)**

**5b. Torque with impact wrench with Adaptive torque module (M8-M12)**

**Diamond coring (M8, M10, M12, M16, M20, M24)**

**1. Core the hole**

**2. Flushing**

**3. Clean the hole**

**4a. Insert the anchor with hammer**

**4b. Use a setting tool HS-SC**

**5. Check**

**6a. Torque with calibrated torque wrench (M8-M24)**

**6b. Torque with impact wrench with Adaptive torque module (M8-M12)**

Chemical anchors

Expansion

Mechanical anchors

Plastic/Light duty metal anchors

Insulation anchors

# HST2 Expansion anchor

Everyday standard expansion anchor for cracked concrete

## Anchor version



HST2  
HST2-R  
(M8-M16)



HST2-BW  
HST2-R-BW  
(M8-M16)

## Benefits

- Optimized expansion cone and wedge design combined with special steel and coatings.
- Suitable for non-cracked and cracked concrete
- Product and length identification mark facilitates quality control and inspection

## Base material



Concrete  
(non-cracked)



Concrete  
(cracked)

## Load conditions

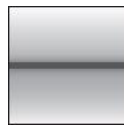

Static/  
quasi-static



Fire  
resistance



Seismic  
ETA-C1, C2

## Installation conditions

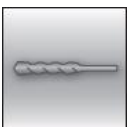

Hammer  
drilled holes



Diamond  
drilled holes

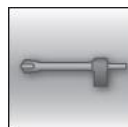

Hollow drill-  
bit drilling

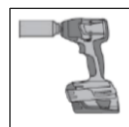

Impact wrench  
with adaptative  
torque module



European  
Technical  
Assessment



CE  
conformity



PROFIS  
Anchor design  
Software



FM  
approved

## Approvals / certificates

Description	Authority / Laboratory	No. / date of issue
European technical assessment <sup>a)</sup>	DIBt, Berlin	ETA-15/0435 / 2017-12-21
Fire test report	DIBt, Berlin	ETA-15/0435 / 2017-12-21

a) All data given in this section according to ETA-15/0435, issue 2017-12-21.



## Static and quasi-static loading (for a single anchor)

### All data in this section applies to:

- Correct setting (See setting instruction)
- No edge distance and spacing influence
- Steel failure
- Minimum base material thickness
- Concrete C 20/25,  $f_{ck,cube} = 25 \text{ N/mm}^2$

### Effective anchorage depth for static

Anchor size		M8	M10	M12	M16
Eff. Anchorage depth	$h_{ef}$ [mm]	47	60	70	82

### Characteristic resistance

Anchor size		M8	M10	M12	M16	
<b>Non-cracked concrete</b>						
Tension $N_{Rk}$	HST2/HST2-BW	[kN]	9,0	16,0	20,0	35,0
	HST2-R/HST2-R-BW		9,0	16,0	20,0	35,0
Shear $V_{Rk}$	HST2/HST2-BW	[kN]	11,4	21,6	31,4	55,3
	HST2-R/HST2-R-BW		15,7	25,3	36,7	63,6
<b>Cracked concrete</b>						
Tension $N_{Rk}$	HST2/HST2-BW	[kN]	5,0	9,0	12,0	20,0
	HST2-R/HST2-R-BW		5,0	9,0	12,0	25,0
Shear $V_{Rk}$	HST2/HST2-BW	[kN]	11,4	21,6	31,4	55,3
	HST2-R/HST2-R-BW		15,7	25,3	36,7	63,6

### Design resistance

Anchor size		M8	M10	M12	M16	
<b>Non-cracked concrete</b>						
Tension $N_{Rd}$	HST2/HST2-BW	[kN]	6,0	10,7	13,3	23,3
	HST2-R/HST2-R-BW		6,0	10,7	13,3	23,3
Shear $V_{Rd}$	HST2/HST2-BW	[kN]	9,1	17,3	25,1	44,2
	HST2-R/HST2-R-BW		12,6	20,2	29,4	50,9
<b>Cracked concrete</b>						
Tension $N_{Rd}$	HST2/HST2-BW	[kN]	3,3	6,0	8,0	13,3
	HST2-R/HST2-R-BW		3,3	6,0	8,0	16,7
Shear $V_{Rd}$	HST2/HST2-BW	[kN]	9,1	17,3	25,1	44,2
	HST2-R/HST2-R-BW		12,6	20,2	29,4	44,6

**Recommended loads <sup>a)</sup>**

Anchor size		M8	M10	M12	M16	
<b>Non-cracked concrete</b>						
Tension $N_{rec}$	HST2/HST2-BW	[kN]	4,3	7,6	9,5	16,7
	HST2-R/HST2-R-BW		4,3	7,6	9,5	16,7
Shear $V_{rec}$	HST2/HST2-BW	[kN]	6,5	12,3	17,9	31,6
	HST2-R/HST2-R-BW		9,0	14,5	21,0	35,7
<b>Cracked concrete</b>						
Tension $N_{rec}$	HST2/HST2-BW	[kN]	2,4	4,3	5,7	9,5
	HST2-R/HST2-R-BW		2,4	4,3	5,7	11,9
Shear $V_{rec}$	HST2/HST2-BW	[kN]	6,5	12,3	17,9	31,6
	HST2-R/HST2-R-BW		9,0	14,5	21,0	31,8

a) With overall partial safety factor for action  $\gamma = 1,4$ , The partial safety factors for action depend on the type of loading and shall be taken from national regulations,



### Seismic loading (for a single anchor)

**All data in this section applies to:**

- Correct setting (See setting instruction)
- No edge distance and spacing influence
- Steel failure
- Minimum base material thickness
- Concrete C 20/25,  $f_{ck,cube} = 25 \text{ N/mm}^2$
- $\alpha_{gap} = 1,0$  (using Hilti seismic filling set)

**Effective anchorage depth for static**

Anchor size		M10	M12	M16
Eff. Anchorage depth	$h_{ef}$ [mm]	60	70	82

**Characteristic resistance in case of seismic performance C2**

Anchor size		M10	M12	M16
Tension	HST2/HST2-BW [kN]	3,3	10,0	12,8
$N_{Rk,seis}$				
Shear	HST2/HST2-BW [kN]	16,0	24,2	41,3
$V_{Rk,seis}$				

**Design resistance in case of seismic performance C2**

Anchor size		M10	M12	M16
Tension	HST2/HST2-BW [kN]	2,2	6,7	8,5
$N_{Rd,seis}$				
Shear	HST2/HST2-BW [kN]	12,8	19,4	33,0
$V_{Rd,seis}$				

**Characteristic resistance in case of seismic performance C1**

Anchor size		M10	M12	M16
Tension	HST2/HST2-BW [kN]	8,0	10,7	18,0
$N_{Rk,seis}$				
Shear	HST2/HST2-BW [kN]	16,0	27,0	41,3
$V_{Rk,seis}$				

**Design resistance in case of seismic performance C1**

Anchor size		M10	M12	M16
Tension	HST2/HST2-BW [kN]	5,3	7,1	12,0
$N_{Rd,seis}$				
Shear	HST2/HST2-BW [kN]	12,8	21,6	33,0
$V_{Rd,seis}$				

## Fire resistance

### All data in this section applies to:

- Correct setting (See setting instruction)
- No edge distance and spacing influence
- Steel failure
- Minimum base material thickness
- Concrete C 20/25,  $f_{ck,cube} = 25 \text{ N/mm}^2$
- Hilti technical data for concrete strength class C55/67 to C80/95: for a structural element that fulfills the requirements according to DIN EN 1992-1-2 the fire resistance of C20/25 could be assumed.
- partial safety factor for resistance under fire exposure  $\gamma_{M,fi}=1,0$  (in absence of other national regulations)

### Effective anchorage depth for static

Anchor size	M8	M10	M12	M16
Eff. Anchorage depth $h_{ef}$ [mm]	47	60	70	82

### Characteristic resistance

Anchor size	M8	M10	M12	M16	
<b>Fire Exposure R30</b>					
Tension $N_{Rk,fi}$	HST2/HST2-BW [kN]	0,9	2,3	3,0	5,0
	HST2-R/HST2-R-BW	0,9	2,3	3,0	5,0
Shear $V_{Rk,fi}$	HST2/HST2-BW [kN]	0,9	2,5	5,0	9,0
	HST2-R/HST2-R-BW	0,9	2,5	5,0	9,0
<b>Fire Exposure R120</b>					
Tension $N_{Rk,fi}$	HST2/HST2-BW [kN]	0,5	0,7	1,0	2,0
	HST2-R/HST2-R-BW	0,5	0,7	1,0	2,0
Shear $V_{Rk,fi}$	HST2/HST2-BW [kN]	0,5	0,7	1,0	2,0
	HST2-R/HST2-R-BW	0,5	0,7	1,0	2,0

### Design resistance

Anchor size	M8	M10	M12	M16	
<b>Fire Exposure R30</b>					
Tension $N_{Rd,fi}$	HST2/HST2-BW [kN]	0,9	2,3	3,0	5,0
	HST2-R/HST2-R-BW	0,9	2,3	3,0	5,0
Shear $V_{Rd,fi}$	HST2/HST2-BW [kN]	0,9	2,5	5,0	9,0
	HST2-R/HST2-R-BW	0,9	2,5	5,0	9,0
<b>Fire Exposure R120</b>					
Tension $N_{Rd,fi}$	HST2/HST2-BW [kN]	0,5	0,7	1,0	2,0
	HST2-R/HST2-R-BW	0,5	0,7	1,0	2,0
Shear $V_{Rd,fi}$	HST2/HST2-BW [kN]	0,5	0,7	1,0	2,0
	HST2-R/HST2-R-BW	0,5	0,7	1,0	2,0

## Materials

### Mechanical properties

Anchor size		M8	M10	M12	M16
Nominal tensile strength $f_{uk,thread}$	HST2/HST2-BW [N/mm <sup>2</sup> ]	660	730	710	720
	HST2-R/HST2-R-BW	720	710	710	650
Yield strength $f_{yk,thread}$	HST2/HST2-BW [N/mm <sup>2</sup> ]	528	584	568	576
	HST2-R/HST2-R-BW	576	568	568	520
Stressed cross-section $A_s$	[mm <sup>2</sup> ]	36,6	58,0	84,3	157
Moment of resistance $W$	[mm <sup>3</sup> ]	31,2	62,3	109	277
Char, bending resistance $M^0_{Rk,s}$	HST2/HST2-BW [Nm]	25	55	93	240
	HST2-R/HST2-R-BW	27	53	93	216

### Material quality

Part		Material
Bolt	HST2/HST2-BW	Carbon steel, galvanized
	HST2-R/HST2-R-BW	Stainless steel

### Anchor dimensions

Anchor size		M8	M10	M12	M16
Minimum thickness of fixture	$t_{fix,min}$ [mm]	2	2	2	2
Maximum thickness of fixture	$t_{fix,max}$ [mm]	195	200	200	235
Shaft diameter at the cone	$d_R$ [mm]	5,5	7,2	8,5	11,6
Maximum length of anchor	$l_{1,max}$ [mm]	75	90	105	140
Minimum length of anchor	$l_{1,min}$ [mm]	260	280	295	350
Length of expansion sleeve	$l_2$ [mm]	14,8	18,2	22,7	24,3

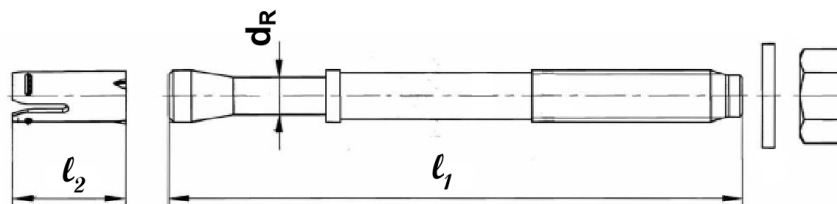

## Setting information

### Setting details

Anchor size		M8	M10	M12	M16
Nominal diameter of drill bit	$d_o$ [mm]	8	10	12	16
Cutting diameter of drill bit	$d_{cut} \leq$ [mm]	8,45	10,45	12,50	16,50
Drill hole depth <sup>1)</sup>	$h_{1,1} \geq$ [mm]	60	74	88	103
	$h_{1,2} \geq$ [mm]	65	75	90	105
Diameter of clearance hole in the fixture	$d_f$ [mm]	9	12	14	18
Torque moment	$T_{inst}$ [Nm]	20	45	60	110
Width across	SW [mm]	13	17	19	24

1)  $h_{1,1}$  valid for hammer drilled holes and  $h_{1,2}$  valid for diamond drilled holes.

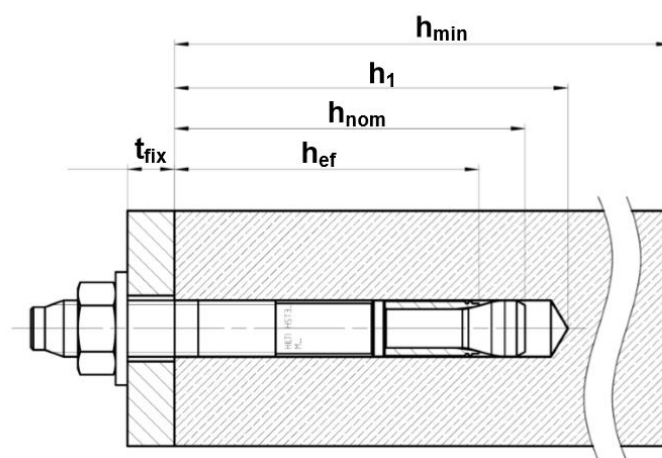

### Installation equipment

Anchor size	M8	M10	M12	M16
Rotary hammer	TE2 – TE16			
Diamond coring tool	DD – 30W, DD – EC1			
Hollow drill bit	-	-	TE – CD, TE – YD	
Other tools	hammer, torque wrench, blow ut pump			

### Setting parameters

Anchor Size			M8		M10		M12		M16		
Effective anchorage depth	$h_{ef}$	[mm]	47		60		70		82		
Minimum base material thickness	$h_{min}$	[mm]	100	800	120	100	140	120	160	140	
Minimum spacing in <i>non-cracked</i> concrete	HST2/HST2-BW	$s_{min}$	[mm]	60	60	55	55	60	60	70	80
		for $c \geq$	[mm]	50	75	80	115	85	100	110	140
	HST2/HST2-BW	$s_{min}$	[mm]	60	60	55	55	60	60	70	80
		for $c \geq$	[mm]	60	75	70	115	80	100	110	140
Minimum spacing in <i>cracked</i> concrete	HST2/HST2-BW	$s_{min}$	[mm]	40	50	55	55	60	60	70	80
		for $c \geq$	[mm]	50	60	70	110	75	100	100	140
	HST2/HST2-BW	$s_{min}$	[mm]	40	50	55	55	60	60	70	80
		for $c \geq$	[mm]	50	60	65	110	75	100	100	140
Minimum edge distance in <i>non-cracked</i> concrete	HST2/HST2-BW	$c_{min}$	[mm]	50	70	55	70	55	70	85	80
		for $s \geq$	[mm]	60	80	115	110	145	130	160	180
	HST2/HST2-BW	$c_{min}$	[mm]	60	70	50	70	55	70	70	80
		for $c \geq$	[mm]	60	80	115	110	145	130	160	180
Minimum edge distance in <i>cracked</i> concrete	HST2/HST2-BW	$c_{min}$	[mm]	45	55	55	70	55	70	70	80
		for $s \geq$	[mm]	50	60	90	100	120	130	150	180
	HST2/HST2-BW	$c_{min}$	[mm]	45	55	50	70	55	70	60	80
		for $c \geq$	[mm]	50	60	90	100	110	130	160	180
Critical spacing for splitting failure and concrete cone failure	$s_{cr,sp}$	[mm]	141		180		210		246		
	$s_{cr,N}$	[mm]	141		180		210		246		
Critical spacing for splitting failure and concrete cone failure	$c_{cr,sp}$	[mm]	71		90		105		123		
	$c_{cr,N}$	[mm]	71		90		105		123		

For spacing (edge distance) smaller than critical spacing (critical edge distance) the design loads have to be reduced.

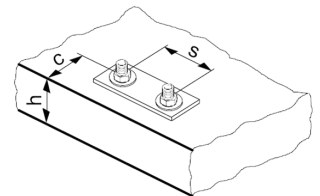

## Setting instructions

\*For detailed information on installation see instruction for use given with the package of the product

### Setting instruction

#### Hammer drilling

##### 1. Drill the hole

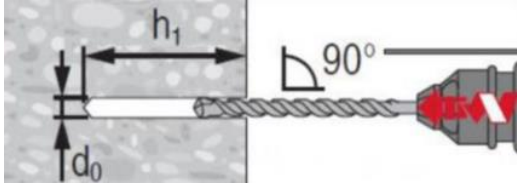

##### 2. Clean the hole

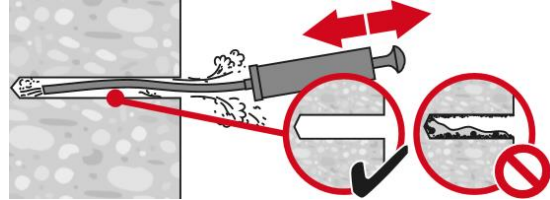

##### 3a. Insert the anchor with hammer

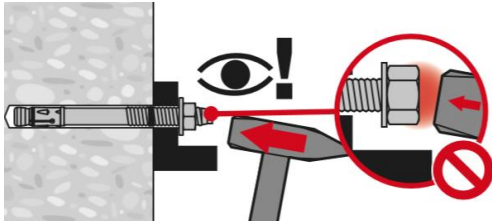

##### 3a. Insert the anchor with setting tool HS-SC (M8-M16)

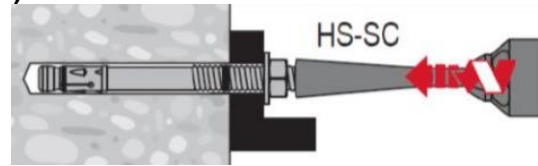

##### 4. Check

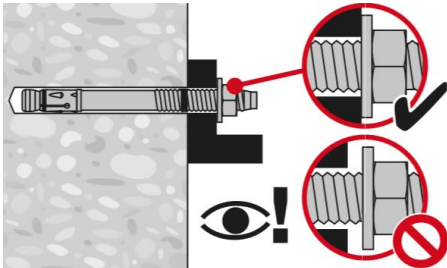

##### 5a. Torque with calibrated torque wrench (M8-M24)

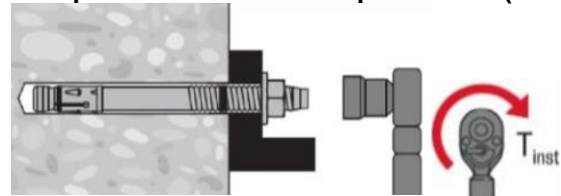

##### 5b. Torque with impact wrench with Adaptive torque module (M8-M12)

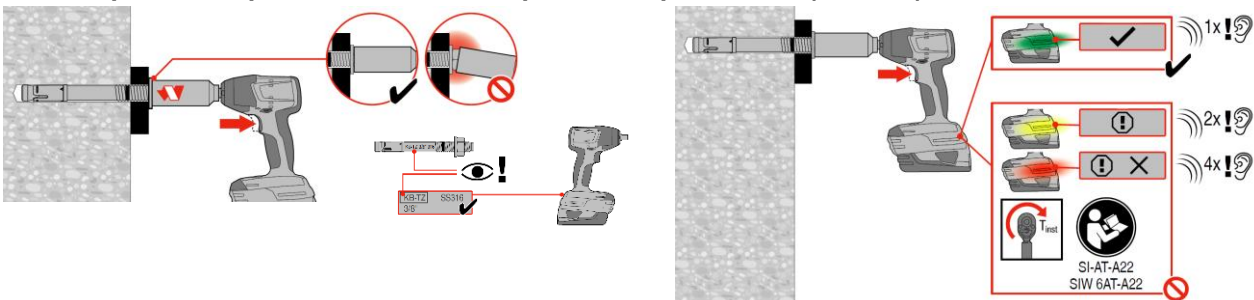

#### Hollow Drill Bit, no cleaning required

##### 1. Drill the hole with the Hollow drill bit

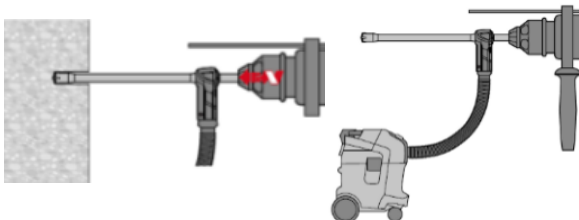

##### 2a. Insert the anchor with hammer

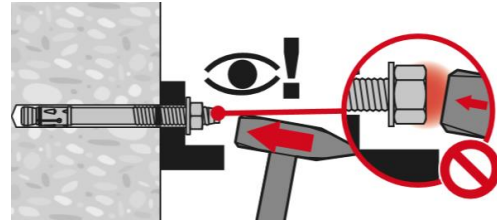

##### 2a. Insert the anchor with setting tool HS-SC

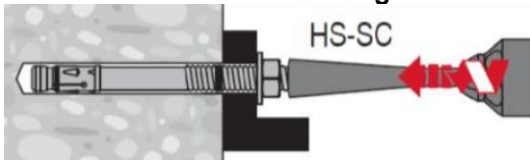

##### 3. Check

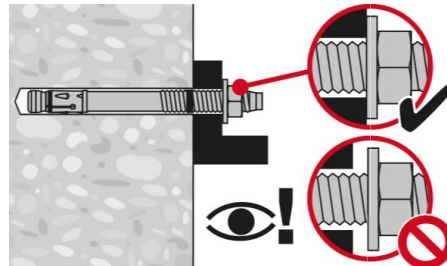



**4a. Torque with calibrated torque wrench (M8-M24)**

**4b. Torque with impact wrench with Adaptive torque module (M8-M12)**

**Diamond coring**

**1. Core the hole**

**2. Flushing**

**3. Clean the hole**

**4a. Insert the anchor with hammer**

**4b. Insert the anchor with setting tool HS-SC (M8-M16)**

**5. Check**

**6a. Torque with calibrated torque wrench (M8-M24)**

**6b. Torque with impact wrench with Adaptive torque module (M8-M12)**

Chemical anchors

Expansion  
Mechanical anchors

Plastic/Light duty metal anchors

Insulation anchors



# HSA Expansion anchor

Everyday standard expansion anchor for uncracked concrete



Chemical anchors







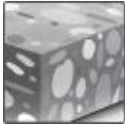
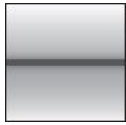

Expansion

Mechanical anchors

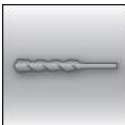
Plastic/Light duty metal anchors

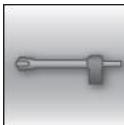
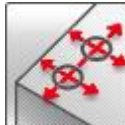
Insulation anchors

Anchor version	Benefits
 <p>HSA HSA-F HSA-R HSA-R2 (M6-M20)</p>	<ul style="list-style-type: none"> <li>- Fast &amp; convenient setting behaviour</li> <li>- Reliable ETA approved torquing using impact wrench with torque bar for torque control</li> <li>- Small edge and spacing distances</li> <li>- High loads</li> <li>- Three embedment depths for maximal design flexibility</li> <li>- M12, M16 and M20 ETA approved for diamond cored holes using DD 30-W and matching diamond core bit</li> <li>- Suitable for pre- and through fastening</li> <li>- Long lengths available suitable for wood structures fastening applications</li> </ul>
 <p>HSA-BW (M6-M20)</p>	

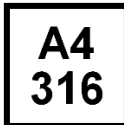
Base material	Load conditions
 <p>Concrete (non-cracked)</p>	 <p>Static/ quasi-static</p>  <p>Fire resistance</p>
Installation conditions	Other information
 <p>Hammer drilled holes</p>  <p>Diamond drilled holes</p>  <p>Hollow drill- bit drilling</p>  <p>Small edge distance and spacing</p>	 <p>European Technical Assessment</p>  <p>CE conformity</p>  <p>PROFIS Anchor design Software</p>  <p>A4 316 Corrosion resistance</p>

## Approvals / certificates

Description	Authority / Laboratory	No. / date of issue
European technical assessment <sup>a)</sup>	DIBt, Berlin	ETA-11/0374 / 2016-08-08

a) All data given in this section according to ETA-11/0374, issue 2016-08-08.

## Static and quasi-static loading (for a single anchor)

### All data in this section applies to:

- Correct setting (See setting instruction)
- No edge distance and spacing influence
- **Steel** failure
- Minimum base material thickness
- Concrete C 20/25,  $f_{ck,cube} = 25 \text{ N/mm}^2$

### Effective anchorage depth

Anchor size			M6			M8			M10		
Eff. Anchorage depth	$h_{ef}$	[mm]	30	40	60	30	40	70	40	50	80
Anchor size			M12			M16			M20		
Eff. Anchorage depth	$h_{ef}$	[mm]	50	65	100	65	80	120	75	100	115

### Characteristic resistance

Anchor size			M6			M8			M10		
Eff. Anchorage depth	$h_{ef}$	[mm]	30	40	60	30	40	70	40	50	80
Tension $N_{Rk}$	HSA, HSA-BW	[kN]	6,0	7,5	9,0	8,3	12,8	16,0	12,8	17,9	25,0
	HSA-R2, HSA-R		6,0	7,5	9,0	8,3	12,8	16,0	12,8	17,9	25,0
	HSA-F		6,0	7,5	9,0	8,3	12,8	15,9	12,8	17,9	25,0
Shear $V_{Rk}$	HSA, HSA-BW	[kN]	6,5	6,5	6,5	8,3	10,6	10,6	18,9	18,9	18,9
	HSA-R2, HSA-R		7,2	7,2	7,2	8,3	12,3	12,3	22,6	22,6	22,6
	HSA-F		6,5	6,5	6,5	8,3	10,6	10,6	18,9	18,9	18,9
Anchor size			M12			M16			M20		
Eff. Anchorage depth	$h_{ef}$	[mm]	50	65	100	65	80	120	75	100	115
Tension $N_{Rk}$	HSA, HSA-BW	[kN]	17,9	26,5	35,0	26,5	36,1	50,0	32,8	50,5	62,3
	HSA-R2, HSA-R		17,9	26,5	35,0	26,5	36,1	50,0	32,8	50,5	62,3
	HSA-F		17,9	26,5	35,0	26,5	36,1	50,0	32,8 <sup>b)</sup>	50,5 <sup>b)</sup>	62,3 <sup>b)</sup>
Shear $V_{Rk}$	HSA, HSA-BW	[kN]	29,5	29,5	29,5	51,0	51,0	51,0	65,6	85,8	85,8
	HSA-R2, HSA-R		29,3	29,3	29,3	56,5	56,5	56,5	65,6	91,9	91,9
	HSA-F		29,5	29,5	29,5	51,0	51,0	51,0	65,6 <sup>b)</sup>	85,8 <sup>b)</sup>	85,8 <sup>b)</sup>

b) Data covered by Hilti Technical Data.

### Design resistance

Anchor size			M6			M8			M10		
Eff. Anchorage depth	$h_{ef}$	[mm]	30	40	60	30	40	70	40	50	80
Tension $N_{Rd}$	HSA, HSA-BW	[kN]	4,0	5,0	6,0	5,5	8,5	10,7	8,5	11,9	16,7
	HSA-R2, HSA-R		4,0	5,0	6,0	5,5	8,5	10,7	8,5	11,9	16,7
	HSA-F		4,0	5,0	6,0	5,5	8,5	10,7	8,5	11,9	16,7
Shear $V_{Rd}$	HSA, HSA-BW	[kN]	5,2	5,2	5,2	5,5	8,5	8,5	15,1	15,1	15,1
	HSA-R2, HSA-R		5,5	5,8	5,8	5,5	9,8	9,8	18,1	18,1	18,1
	HSA-F		5,2	5,2	5,2	5,5	8,5	8,5	15,1	15,1	15,1
Anchor size			M12			M16			M20		
Eff. Anchorage depth	$h_{ef}$	[mm]	50	65	100	65	80	120	75	100	115
Tension $N_{Rd}$	HSA, HSA-BW	[kN]	11,9	17,6	23,3	17,6	24,1	33,3	21,9	33,7	41,5
	HSA-R2, HSA-R		11,9	17,6	23,3	17,6	24,1	33,3	21,9	33,7	41,5
	HSA-F		11,9	17,6	23,3	17,6	24,1	33,3	21,9 <sup>b)</sup>	33,7 <sup>b)</sup>	41,5 <sup>b)</sup>
Shear $V_{Rd}$	HSA, HSA-BW	[kN]	23,6	23,6	23,6	40,8	40,8	40,8	43,7	68,6	68,6
	HSA-R2, HSA-R		23,4	23,4	23,4	45,2	45,2	45,2	43,7	73,5	73,5
	HSA-F		23,6	23,6	23,6	40,8	40,8	40,8	43,7 <sup>b)</sup>	68,6 <sup>b)</sup>	68,6 <sup>b)</sup>

b) Data covered by Hilti Technical Data.

**Recommended loads <sup>a)</sup>**

Anchor size		M6			M8			M10			
Eff. Anchorage depth $h_{ef}$ [mm]		30	40	60	30	40	70	40	50	80	
Tension $N_{rec}$	HSA, HSA-BW	[kN]	2,9	3,6	4,3	4,0	6,1	7,6	6,1	8,5	11,9
	HSA-R2, HSA-R		2,9	3,6	4,3	4,0	6,1	7,6	6,1	8,5	11,9
	HSA-F		2,9	3,6	4,3	4,0	6,1	7,6	6,1	8,5	11,9
Shear $V_{rec}$	HSA, HSA-BW	[kN]	3,7	3,7	3,7	4,0	6,1	6,1	10,8	10,8	10,8
	HSA-R2, HSA-R		4,0	4,1	4,1	4,0	7,0	7,0	12,9	12,9	12,9
	HSA-F		3,7	3,7	3,7	4,0	6,1	6,1	10,8	10,8	10,8
Anchor size		M12			M16			M20			
Eff. Anchorage depth $h_{ef}$ [mm]		50	65	100	65	80	120	75	100	115	
Tension $N_{rec}$	HSA, HSA-BW	[kN]	8,5	12,6	16,7	12,6	17,2	23,8	15,6	24,0	29,7
	HSA-R2, HSA-R		8,5	12,6	16,7	12,6	17,2	23,8	15,6	24,0	29,7
	HSA-F		8,5	12,6	16,7	12,6	17,2	23,8	15,6 <sup>b)</sup>	24,0 <sup>b)</sup>	29,7 <sup>b)</sup>
Shear $V_{rec}$	HSA, HSA-BW	[kN]	16,9	16,9	16,9	29,1	29,1	29,1	31,2	49,0	49,0
	HSA-R2, HSA-R		16,7	16,7	16,7	32,3	32,3	32,3	31,2	52,5	52,5
	HSA-F		16,9	16,9	16,9	29,1	29,1	29,1	31,2 <sup>b)</sup>	49,0 <sup>b)</sup>	49,0 <sup>b)</sup>

a) With overall partial safety factor for action  $\gamma = 1,4$ . The partial safety factors for action depend on the type of loading and shall be taken from national regulations.

b) Data covered by Hilti Technical data

**Materials**
**Mechanical properties**

Anchor size		M6	M8	M10	M12	M16	M20	
Nominal tensile strength $f_{uk,thread}$	HSA, HSA-BW, HSA-F	[N/mm <sup>2</sup> ]	650	580	650	700	650	700
	HSA-R2, HSA-R		650	560	650	580	600	625
Yield strength $f_{yk,thread}$	HSA, HSA-BW, HSA-F	[N/mm <sup>2</sup> ]	520	464	520	560	520	560
	HSA-R2, HSA-R		520	448	520	464	480	500
Stressed cross-section $A_s$		[mm <sup>2</sup> ]	20,1	36,6	58	84,3	157	245
Moment of resistance $W$		[mm <sup>3</sup> ]	12,7	31,2	62,3	109,2	277,5	540,9
Char. bending resistance	HSA, HSA-BW, HSA-F	[Nm]	9,9	21,7	48,6	91,7	216,4	454,4
	HSA-R2, HSA-R		9,9	21	48,6	76	199,8	405,7

### Material quality

Part		Material
HSA HSA-BW (Carbon steel)	Bolt	Galvanized ( $\geq 5 \mu\text{m}$ )
	Sleeve	Galvanized ( $\geq 5 \mu\text{m}$ )
	Washer	Galvanized ( $\geq 5 \mu\text{m}$ )
	Hexagon nut	Strength class 8 / Galvanized ( $\geq 5 \mu\text{m}$ )
HSA-R2 (Stainless steel)	Bolt	Stainless steel A2, 1.4301; M6-M20 coated
	Sleeve	Stainless steel A2
	Washer	Stainless steel A2
	Hexagon nut	Stainless steel A2; / M6-M20 coated
HSA-R (Stainless steel)	Bolt	Stainless steel A4, 1.4401 or 1.4362 / M6-M20 coated
	Sleeve	Stainless steel A2
	Washer	Stainless steel A4
	Hexagon nut	Stainless steel A4; / M6-M20 coated
HSA-F (Carbon steel)	Bolt	Hot-dip galvanized ( $\geq 42 \mu\text{m}$ )
	Sleeve	Stainless steel A2
	Washer	Hot-dip galvanized ( $\geq 42 \mu\text{m}$ )
	Hexagon nut	Strength class 8 / Hot-dip galvanized ( $\geq 42 \mu\text{m}$ )

### Geometry washer

Anchor size		M6	M8	M10	M12	M16	M20
<b>Inner diameter <math>d_1</math></b>							
HSA, HSA-R2, HSA-R, HSA-F	$d_1$ [mm]	6,4	8,4	10,5	13,0	17,0	21
HSA-BW	$d_1$ [mm]	6,4	8,4	10,5	13,0	17,0	22
<b>Outer diameter <math>d_2</math></b>							
HSA, HSA-R2, HSA-R, HSA-F	$d_2$ [mm]	12,0	16,0	20,0	24,0	30,0	37,0
HSA-BW	$d_2$ [mm]	18,0	24,0	30,0	37,0	50,0	60,0
<b>Thickness <math>h</math></b>							
HSA, HSA-R2, HSA-R, HSA-F	$h$ [mm]	1,6	1,6	2,0	2,5	3,0	3,0
HSA-BW	$h$ [mm]	1,8	2,0	2,5	3,0	3,0	4,0

### Product marking and identification of anchor:

**Beginning of thread:** setting depth indicator for  $h_{\text{nom},1}$

$h_{\text{nom},1}$  is reached when non-threaded part of the bolt is completely below the concrete surface

**Blue ring:** setting depth indicator for  $h_{\text{nom},2}$

$h_{\text{nom},2}$  is reached when the blue ring is completely below the concrete surface

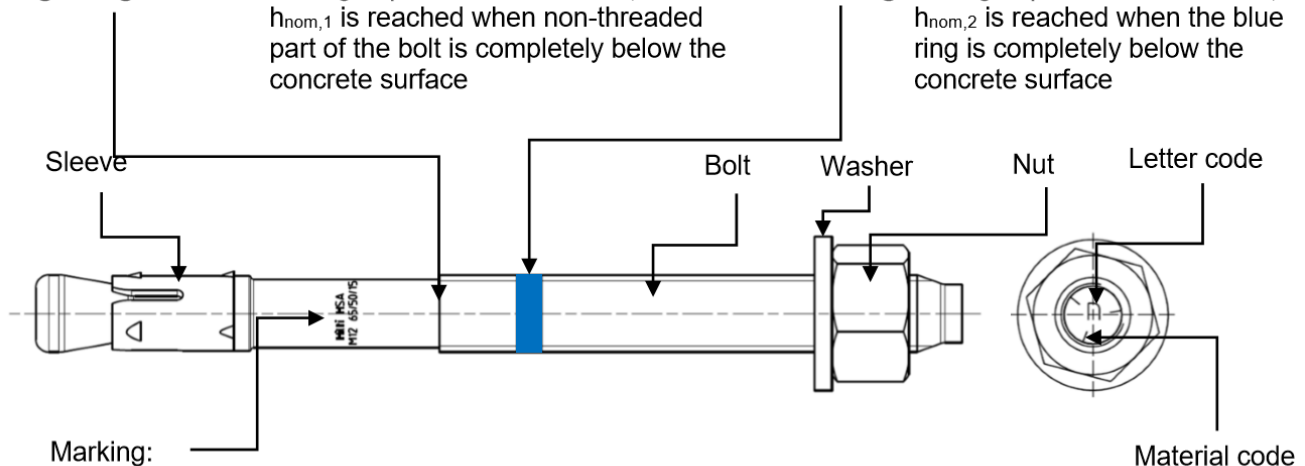

e.g.  
 Hilti HSA ... Brand and Anchor type  
 M12 65/50/15 ... Anchor Size and the max.  $t_{\text{fix},1}$  /  $t_{\text{fix},2}$  /  $t_{\text{fix},3}$  for the corresponding  $h_{\text{nom},1}$  /  $h_{\text{nom},2}$  /  $h_{\text{nom},3}$

### Material code for identification of different materials

Type	HSA, HSA-BW, HSA-F (carbon steel)	HSA-R2 (Stainless steel grade A2)	HSA-R (stainless steel grade A4)
Material code			
	Letter code without mark	Letter code with two marks	Letter code with three marks

### Letter code for anchor length and maximum thickness of the fixture $t_{fix}$

Type	HSA, HSA-BW, HSA-R2, HSA-R, HSA-F						
	Size	M6	M8	M10	M12	M16	M20
$h_{nom}$ [mm]		37 / 47 / 67	39 / 49 / 79	50 / 60 / 90	64 / 79 / 114	77 / 92 / 132	90 / 115 / 130
Letter	$t_{fix}$	$t_{fix,1}/t_{fix,2}/t_{fix,3}$	$t_{fix,1}/t_{fix,2}/t_{fix,3}$	$t_{fix,1}/t_{fix,2}/t_{fix,3}$	$t_{fix,1}/t_{fix,2}/t_{fix,3}$	$t_{fix,1}/t_{fix,2}/t_{fix,3}$	$t_{fix,1}/t_{fix,2}/t_{fix,3}$
<b>z</b>		<b>5/-/-</b>	<b>5/-/-</b>	<b>5/-/-</b>	<b>5/-/-</b>	<b>5/-/-</b>	5/-/-
<b>y</b>		10/-/-	10/-/-	10/-/-	10/-/-	10/-/-	<b>10/-/-</b>
<b>x</b>		15/5/-	15/5/-	15/5/-	15/-/-	15/-/-	15/-/-
<b>w</b>		<b>20/10/-</b>	<b>20/10/-</b>	<b>20/10/-</b>	<b>20/5/-</b>	<b>20/5/-</b>	20/-/-
<b>v</b>		25/15/-	25/15/-	25/15	25/10/-	25/10/-	25/-/-
<b>u</b>		30/20/-	30/20/-	30/20/-	30/15/-	30/15/-	30/5/-
<b>t</b>		35/25/5	<b>35/25/-</b>	<b>35/25/-</b>	<b>35/20/-</b>	35/20/-	35/10/-
<b>s</b>		<b>40/30/10</b>	40/30/-	40/30/-	40/25/-	<b>40/25/-</b>	40/15/-
<b>r</b>		45/35/15	45/35/5	45/35/5	45/30/-	45/30/-	45/20/5
<b>q</b>		50/40/20	50/40/10	<b>50/40/10</b>	50/35/-	50/35/-	50/25/10
<b>p</b>		<b>55/45/25</b>	<b>55/45/15</b>	55/45/15	55/40/5	55/40/-	<b>55/30/15</b>
<b>o</b>		60/50/30	60/50/20	60/50/20	60/45/10	60/45/5	60/35/20
<b>n</b>		65/55/35	65/55/25	65/55/25	<b>65/50/15</b>	65/50/10	65/40/25
<b>m</b>		70/60/40	70/60/30	<b>70/60/30</b>	70/55/20	70/55/15	70/45/30
<b>l</b>		75/65/45	75/65/35	75/65/35	75/60/25	75/60/20	75/50/35
<b>k</b>		80/70/50	<b>80/70/40</b>	80/70/40	80/65/30	80/65/25	80/55/40
<b>j</b>		85/75/55	85/75/45	85/75/45	85/70/35	<b>85/70/30</b>	85/60/45
<b>i</b>		90/80/60	90/80/50	<b>90/80/50</b>	90/75/40	90/75/35	90/65/50
<b>h</b>		95/85/65	95/85/55	95/85/55	<b>95/80/45</b>	95/80/40	95/70/55
<b>g</b>		100/90/70	100/90/60	100/90/60	100/85/50	100/85/45	100/75/60
<b>f</b>		105/95/75	105/95/65	<b>105/95/65</b>	105/90/55	105/90/50	105/80/65
<b>e</b>		110/100/80	110/100/70	110/100/70	110/95/60	110/95/55	110/85/70
<b>d</b>		115/105/85	115/105/75	115/105/75	115/100/65	115/100/60	115/90/75
<b>c</b>		120/110/90	120/110/80	120/110/80	<b>125/110/75</b>	120/105/65	120/95/80
<b>b</b>		125/115/95	125/115/85	125/115/85	135/120/85	125/110/70	125/100/85
<b>a</b>		130/120/100	130/120/90	130/120/90	<b>145/130/95</b>	<b>135/120/80</b>	130/105/90
<b>aa</b>		-	-	-	155/140/105	145/130/90	-
<b>ab</b>		-	-	-	165/150/115	155/140/100	-
<b>ac</b>		-	-	-	175/160/125	165/150/110	-
<b>ad</b>		-	-	-	180/165/130	190/175/135	-
<b>ae</b>		-	-	-	230/215/180	240/225/185	-
<b>af</b>		-	-	-	280/265/230	290/275/235	-
<b>ag</b>		-	-	-	330/315/280	340/325/285	-

Anchor length in bolt type and grey shaded are standard items. For selection of other anchor length, check availability of the items.

## Setting information

### Setting details

Anchor size			M6			M8			M10		
Nominal anchorage depth	$h_{nom}$	[mm]	37	47	67	39	49	79	50	60	90
Minimum base material thickness	$h_{min}$	[mm]	100	100	120	100	100	120	100	120	160
Minimum spacing	$s_{min}$	[mm]	35	35	35	35	35	35	50	50	50
Minimum edge distance	$c_{min}$	[mm]	35	35	35	40	35	35	50	40	40
Nominal diameter of drill bit	$d_0$	[mm]	6			8			10		
Cutting diameter of drill bit	$d_{cut} \leq$	[mm]	6,4			8,45			10,45		
Depth of drill hole	$h_1 \geq$	[mm]	42	52	72	44	54	84	55	65	95
Diameter of clearance hole in the fixture	$d_r \leq$	[mm]	7			9			12		
Torque moment	$T_{inst}$	[Nm]	5			15			25		
Width across	SW	[mm]	10			13			17		
Anchor size			M12			M16			M20		
Nominal anchorage depth	$h_{nom}$	[mm]	64	79	114	77	92	132	90	115	130
Minimum base material thickness	$h_{min}$	[mm]	100	140	180	140	160	180	160	220	220
Minimum spacing	$s_{min}$	[mm]	70	70	70	90	90	90	195	175	175
Minimum edge distance	$c_{min}$	[mm]	70	65	55	80	75	70	130	120	120
Nominal diameter of drill bit	$d_0$	[mm]	12			16			20		
Cutting diameter of drill bit	$d_{cut} \leq$	[mm]	12,5			16,5			20,55		
Depth of drill hole	$h_1 \geq$	[mm]	72	87	122	85	100	140	98	123	138
Diameter of clearance hole in the fixture	$d_r \leq$	[mm]	14			18			22		
Torque moment	$T_{inst}$	[Nm]	50			80			200		
Width across	SW	[mm]	19			24			30		

For spacing (edge distance) smaller than critical spacing (critical edge distance) the design loads have to be reduced.

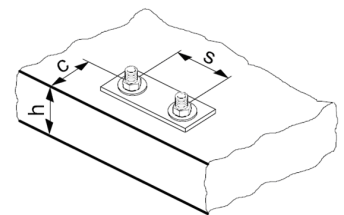

### Installation equipment

Anchor size		M6	M8	M10	M12	M16	M20
Rotary hammer		TE2 – TE16					TE40 – TE80
Other tools		hammer, torque wrench, blow out pump					
Machine tightening							
Setting tool		-	S-TB HSA				-
Impact screw driver		-	Hilti S/W 14-A Hilti S/W 22-A			Hilti S/W 22T-A	-
Speed	HAS, HAS-BW, HAS-F	-	1		3	-1)	-
	HAS-R2, HAS-R	-	3				-
Setting time $t_{set}$ [sec]		-	4				-

1) The impact screw driver operates with a fixed speed.

### Setting parameters

Anchor size		M6			M8			M10		
Nominal anchorage depth	$h_{nom}$ [mm]	37	47	67	39	49	79	50	60	90
Effective anchorage depth	$h_{ef}$ [mm]	30	40	60	30	40	70	40	50	80
Critical spacing for splitting failure	$s_{cr,sp}$ [mm]	100	120	130	130	180	200	190	210	290
Critical edge distance for splitting failure	$c_{cr,sp}$ [mm]	50	60	65	65	90	100	95	105	145
Critical spacing for concrete cone failure	$s_{cr,N}$ [mm]	90	120	180	90	120	210	120	150	240
Critical edge distance for concrete cone failure	$c_{cr,N}$ [mm]	45	60	90	45	60	105	60	75	120
Anchor size		M12			M16			M20		
Nominal anchorage depth	$h_{nom}$ [mm]	64	79	114	77	92	132	90	115	130
Effective anchorage depth	$h_{ef}$ [mm]	50	65	100	65	80	120	75	100	115
Critical spacing for splitting failure	$s_{cr,sp}$ [mm]	200	250	310	230	280	380	260	370	400
Critical edge distance for splitting failure	$c_{cr,sp}$ [mm]	100	125	155	115	140	190	130	185	200
Critical spacing for concrete cone failure	$s_{cr,N}$ [mm]	150	195	300	195	240	360	225	300	345
Critical edge distance for concrete cone failure	$c_{cr,N}$ [mm]	75	97,5	150	97,5	120	180	112,5	150	172,5



## Setting instructions

\*For detailed information on installation see instruction for use given with the package of the product

1. Hole drilling		
<p><b>Hammer drilling (HD): M6-M20</b></p>	<p><b>Hammer drilling with Hilti hollow drill bit (HDB): M12-M20</b></p>	<p><b>Diamond drilling (DD): M10-M20</b></p>
2. Cleaning		
<p><b>Manual cleaning (MC): M6-M20</b></p>	<p><b>Automatic cleaning (AC): M12-M20</b></p>	
3. Anchor setting		
<p><b>Hammer setting: M6-M20</b></p>	<p><b>Machine setting (impact screw driver with setting tool): M8-M16</b></p>	
4. Check setting		
5. Anchor torquing		
<p><b>Torque wrench: M6-M20</b></p>	<p><b>Impact screw driver with setting tool: M8-M16</b></p>	

# HSV Expansion anchor

Economical expansion anchor for uncracked concrete

## Anchor version



HSV (F)  
(M8-M16)



HSV-BW  
(M8-M16)

## Benefits

- Torque-controlled mechanical expansion allows immediate load application
- Setting mark
- Cold-formed to prevent breaking during installation
- Raised impact section prevents thread damage during installation
- Drill bit size is same as anchor size for easy installation.

## Base material



Concrete  
(non-cracked)

## Basic loading data (for a single anchor)

All data in this section applies to:

- Correct setting (See setting instruction)
- No edge distance and spacing influence
- Concrete as specified in the table
- *Steel* failure
- Minimum base material thickness
- Concrete C 20/25,  $f_{ck,cube} = 25 \text{ N/mm}^2$

### Effective anchorage depth for static <sup>a)</sup>

Anchor size	M8		M10		M12		M16	
Eff. anchorage depth range $h_{ef}$ [mm]	30	40	40	50	50	65	65	80

a) HSV-F only for sizes M10, M12 and M16

### Characteristic resistance

Anchor size			M8		M10		M12		M16	
Tension $N_{Rk}$	HSV / HSV-BW	[kN]	8,3	12,0	12,0	14,0	14,5	20,0	26,5	36,1
	HSV-F		-	-	10,0	14,0	14,5	20,0	26,5	36,1
Shear $V_{Rk}$	HSV / HSV-BW	[kN]	8,3	8,5	12,8	14,4	17,9	22,6	42,4	42,4
	HSV-F		-	-	12,8	14,4	17,9	22,6	42,4	42,4

### Design resistance

Anchor size			M8		M10		M12		M16	
Tension $N_{Rd}$	HSV / HSV-BW	[kN]	4,6	6,7	8,0	9,3	9,7	13,3	14,7	20,1
	HSV-F		-	-	6,7	9,3	9,7	13,3	14,7	20,1
Shear $V_{Rd}$	HSV / HSV-BW	[kN]	5,5	6,8	8,5	11,5	11,9	18,1	33,9	33,9
	HSV-F		-	-	8,5	11,5	11,9	18,1	33,9	33,9

### Recommended loads <sup>a)</sup>

Anchor size			M8		M10		M12		M16	
Tension $N_{Rec}$	HSV / HSV-BW	[kN]	3,3	4,8	5,7	6,7	6,9	9,5	10,5	14,3
	HSV-F		-	-	4,8	6,7	6,9	9,5	10,5	14,3
Shear $V_{Rec}$	HSV / HSV-BW	[kN]	4,0	4,9	6,1	8,2	8,5	12,9	24,2	24,2
	HSV-F		-	-	6,1	8,2	8,5	12,9	24,2	24,2

a) With overall partial safety factor for action  $\gamma = 1,4$ . The partial safety factors for action depend on the type of loading and shall be taken from national regulations.

### Materials

#### Mechanical properties <sup>a)</sup>

Anchor size			M8	M10	M12	M16
Nominal tensile strength	$f_{uk}$	[N/mm <sup>2</sup> ]	580	660	660	660
Yield strength	$f_{yk}$	[N/mm <sup>2</sup> ]	464	528	528	528
Stressed cross-section, thread	$A_s$	[mm <sup>2</sup> ]	36,6	58,0	84,3	157
Stressed cross-section, neck	$A_{s, neck}$	[mm <sup>2</sup> ]	26,9	39,6	63,6	105,7
Moment of resistance	W	[mm <sup>3</sup> ]	31,2	62,3	109,2	277,5
Char. bending resistance for rod or bolt with 5.8 steel grade	$M^0_{Rk,s}$	[Nm]	19,5	41,1	72,1	166,5

a) HSV-F only for sizes M10, M12 and M16.

#### Material quality

Part		Material
Bolt	HSV	Carbon steel, galvanized to min. 5 $\mu$ m
	HSV - BW	Carbon steel, galvanized to min. 5 $\mu$ m with DIN 9021 washer and DIN 127b spring washer
	HSV-F	For M10 to M16 hot dipped galvanized to min. 42 $\mu$ m with DIN 9021 washer and DIN 127b spring washer

### Anchor dimension <sup>a)</sup>

Anchor size		M8	M10	M12	M16
Shaft diameter at the cone	$d_R$ [mm]	5,85	7,1	9,0	11,6
Maximum length of the anchor	$l_1$ [mm]	75	100	150	140
Length of expansion sleeve	$l_2$ [mm]	15	17,6	20,6	24

a) HSV-F only for sizes M10, M12 and M16.

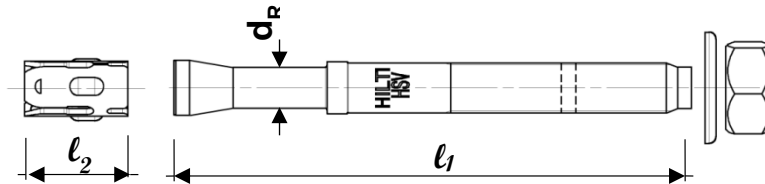

### Setting information

#### Setting details <sup>a)</sup>

Anchor size		M8		M10		M12		M16	
Effective anchorage depth	$h_{ef}$ [mm]	30	40	40	50	50	65	65	80
Nominal embedment depth	$h_{nom}$ [mm]	39	49	51	61	62	77	81	96
Nominal diameter of drill bit	$d_0$ [mm]	8		10		12		16	
Cutting diameter of drill bit	$d_{cut} \leq$ [mm]	8,45		10,45		12,5		16,5	
Depth of drill hole	$h_1 \geq$ [mm]	45	55	60	70	70	85	90	105
Min. thickness of fixture <sup>b)</sup>	$t_{fix,min}$ [mm]	5	0	5	0	5	0	5	0
Max. thickness of fixture <sup>b)</sup>	HSV(-BW) $t_{fix,max}$ [mm]	20	10	35	25	70	55	35	20
	HSV-F	-	-	55	45	60	45	35	20
Diameter of clearance hole in the fixture	$d_f \leq$ [mm]	9		12		14		18	
Torque moment	$T_{inst}$ [Nm]	15		30		50		100	
Width across nut flats	SW [mm]	13		17		19		24	

a) HSV-F only for sizes M10, M12 and M16.

b) The values are only valid for HSV with standard washer. For HSV-BW with DIN 9021 washer and DIN 127b spring washer the thickness of the fixture has to be reduced.

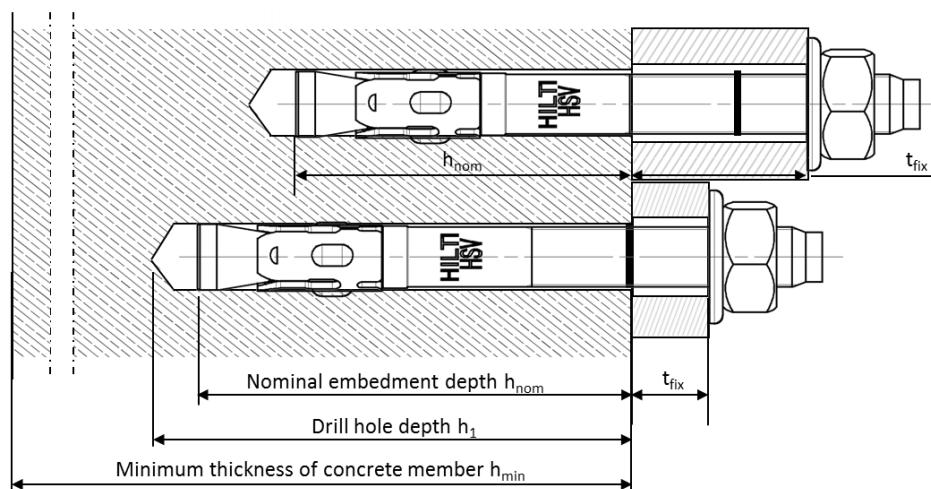

#### Installation equipment <sup>a)</sup>

Anchor size	M8	M10	M12	M16
Rotary hammer	TE 1 – TE 30			
Other tools	Blow out pump, hammer, torque wrench			

a) HSV-F only for sizes M10, M12 and M16.

### Setting parameters <sup>a)</sup>

Anchor size				M8		M10		M12		M16	
Effective anchorage depth	HSV (-BW)	$h_{ef}$	[mm]	30	40	40	50	50	65	65	80
	HSV-F			-	-	40	50	50	65	65	80
Minimum base material thickness	HSV (-BW)	$h_{min} \geq$	[mm]	100	100	100	120	140	140	130	170
	HSV-F			-	-	120	120	140	140	170	170
Minimum spacing	HSV (-BW)	$s_{min} \geq$	[mm]	60	60	70	70	80	80	120	100
	HSV-F			-	-	105	105	120	120	190	190
Minimum edge distance	HSV (-BW)	$c_{min} \geq$	[mm]	60	60	70	70	90	90	120	100
	HSV-F			-	-	105	105	140	140	140	140
Critical spacing for splitting failure <sup>b)</sup>	HSV (-BW)	$s_{cr,sp}$	[mm]	180	240	240	300	300	390	390	480
	HSV-F			-	-	240	300	300	390	390	480
Critical edge distance for splitting failure <sup>b)</sup>	HSV (-BW)	$c_{cr,sp}$	[mm]	90	120	120	150	150	195	195	240
	HSV-F			-	-	120	150	150	195	195	240
Critical spacing for concrete cone failure <sup>b)</sup>	HSV (-BW)	$s_{cr,N}$	[mm]	90	120	120	150	150	195	195	240
	HSV-F			-	-	120	150	150	195	195	240
Critical edge distance for concrete cone failure <sup>b)</sup>	HSV (-BW)	$c_{cr,N}$	[mm]	45	60	60	75	75	97,5	97,5	120
	HSV-F			-	-	60	75	75	97,5	97,5	120

a) HSV-F only for sizes M10, M12 and M16.

b) In a case of smaller edge distance and spacing than  $c_{cr,sp}$ ,  $s_{cr,sp}$ , and  $s_{cr,N}$  the load values shall be reduced according ETAG 001, Annex C.

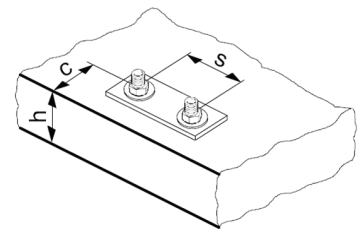

### Setting instruction

\*For detailed information on installation see instruction for use given with the package of the product.

**Setting instruction for HSV (-BW)**

**1. Drilling**

**2. Cleaning**

**3. Inserting the anchor**

**4. Checking**





**5. Checking**

**6. Applying setting tool**

# HSB Expansion anchor

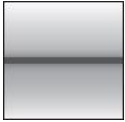
Everyday economical expansion anchor for uncracked concrete

Anchor version	Benefits
 <p>HSB (M8-M16)</p>	<ul style="list-style-type: none"> <li>- Torque-controlled mechanical expansion allows immediate load application</li> <li>- Drill bit size is same as anchor size for easy installation</li> <li>- Suitable for pre- and through-fastening</li> <li>- ETA approved</li> </ul>

Base material	Load conditions
 <p>Concrete (non-cracked)</p>	 <p>Static/ quasi-static</p>
Installation conditions	Other information
 <p>Hammer drilled holes</p>	 <p>European Technical Assessment</p>  <p>CE conformity</p>

### Approvals / certificates

Description	Authority / Laboratory	No. / date of issue
European technical assessment <sup>a)</sup>	DIBt, Berlin	ETA-17/0452 / 2017-07-27

<sup>a)</sup> All data given in this section according to ETA-17/0452, issue 2017-07-27.

### Basic loading data (for a single anchor)

- All data in this section applies to:**
- Correct setting (See setting instruction)
  - No edge distance and spacing influence
  - Concrete as specified in the table
  - *Steel* failure
  - Minimum base material thickness
  - Concrete C 20/25,  $f_{ck,cube} = 25 \text{ N/mm}^2$



### Effective anchorage depth

Anchor size		M8	M10	M12	M16
Eff. anchorage depth range	$h_{ef}$ [mm]	30	40	50	65

### Characteristic resistance

Anchor size		M8	M10	M12	M16
Tension $N_{Rk}$	[kN]	8,3	12,0	14,6	26,5
Shear $V_{Rk}$	[kN]	8,3	12,8	17,9	42,4

### Design resistance

Anchor size		M8	M10	M12	M16
Tension $N_{Rd}$	[kN]	4,6	8,0	9,7	14,7
Shear $V_{Rd}$	[kN]	5,5	8,5	11,9	33,9

### Recommended loads <sup>a)</sup>

Anchor size		M8	M10	M12	M16
Tension $N_{Rec}$	[kN]	3,3	5,7	7,0	10,5
Shear $V_{Rec}$	[kN]	4,0	6,1	8,5	24,2

a) With overall partial safety factor for action  $\gamma = 1,4$ . The partial safety factors for action depend on the type of loading and shall be taken from national regulations.

## Materials

### Mechanical properties

Anchor size		M8	M10	M12	M16
Nominal tensile strength	$f_{uk}$ [N/mm <sup>2</sup> ]	580	660	660	660
Yield strength	$f_{yk}$ [N/mm <sup>2</sup> ]	464	528	528	528
Stressed cross-section, thread	$A_s$ [mm <sup>2</sup> ]	36,6	58,0	84,3	157
Stressed cross-section, neck	$A_{s, neck}$ [mm <sup>2</sup> ]	26,9	39,6	63,6	105,7
Moment of resistance	$W$ [mm <sup>3</sup> ]	31,2	62,3	109,2	277,5
Char. bending resistance for rod or bolt with 5.8 steel grade	$M^0_{Rk,s}$ [Nm]	19,5	41,1	72,1	166,5

### Material quality

Part	Material
Expansion sleeve	Carbon steel, galvanized
Bolt	Carbon steel, galvanized, rupture elongation ( $l_0=5d$ )>8%
Washer	Carbon steel, galvanized
Hexagon nut	Carbon steel, galvanized



### Anchor dimension

Anchor size		M8	M10	M12	M16
Min. inner diameter of washer	$d_1$ [mm]	8,4	10,5	13	17
Min. outer diameter of washer	$d_w$ [mm]	16	20	24	30
Min. thickness of washer	$h$ [mm]	1,6	2	2,5	3

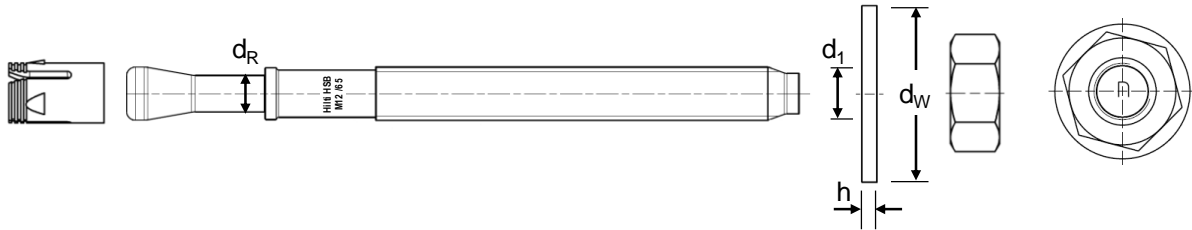

### Letter code for identification of fixture thickness

Anchor size		M8	M10	M12	M16
Letter	$t_{fix}$	[mm]	[mm]	[mm]	[mm]
z		5	5	5	5
w		20	20	20	20
t		35	35	35	-
s		-	-	-	40
q		-	50	-	-
p		55	-	-	-
n		-	-	65	-
m		-	70	-	-
j		-	-	-	85
h		-	-	95	-

### Setting information

#### Setting details

Anchor size		M8	M10	M12	M16
Effective anchorage depth	$h_{ef}$ [mm]	30	40	50	65
Nominal anchorage depth	$h_{nom}$ [mm]	39	50	64	77
Nominal diameter of drill bit	$d_0$ [mm]	8	10	12	16
Cutting diameter of drill bit	$d_{cut} \leq$ [mm]	8,45	10,45	12,5	16,5
Depth of drill hole	$h_1 \geq$ [mm]	44	55	72	85
Diameter of clearance hole in the fixture	$d_f \leq$ [mm]	9	12	14	18
Torque moment	$T_{inst}$ [Nm]	15	30	50	80
Width across flats	SW [mm]	13	17	19	24

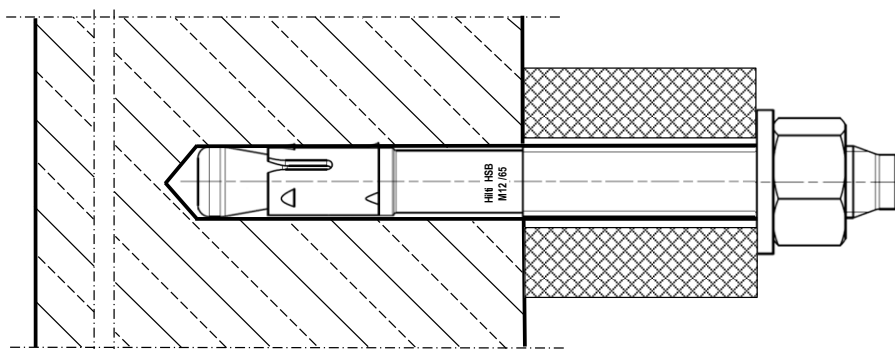

### Installation equipment

Anchor size	M8	M10	M12	M16
Rotary hammer	TE 2 – TE 16			
Other tools	Blow out pump, hammer, torque wrench			

### Setting parameters

Anchor size		M8	M10	M12	M16
Min. thickness of concrete member	$h_{min}$ [mm]	100	100	100	140
Min. spacing	$s_{min} \geq$ [mm]	60	70	80	100
Min. edge distance	$c_{min} \geq$ [mm]	60	70	90	100

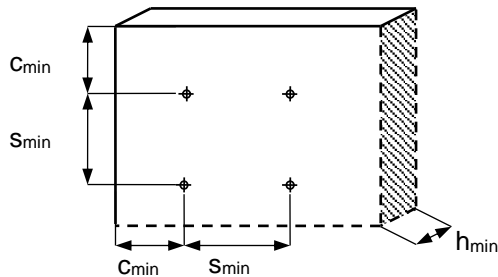

### Setting instruction

\*For detailed information on installation see instruction for use given with the package of the product.

**Setting instruction for HSB**

- 1. Hammer drilling**
- 2. Manual cleaning**
- 3. Insert the anchor**
- 4. Check setting**
- 5. Torque wrench**
- 6. Check installation**

# HUS3 Screw anchor

Ultimate performance screw anchor for single point fastening

Chemical anchors

Screw

Mechanical anchors

Plastic/Light duty metal anchors

Insulation anchors

## Anchor version



HUS3-H  
(6-14)

## Benefits

- High productivity - less drilling and fewer operations than with conventional anchors



HUS3-HF  
(8-14)

- ETA approval for cracked and non-cracked concrete
- ETA approval for Seismic C1 and C2



HUS3-C  
(8-10)

- ETA approval for adjustability (unscrew-rescrew)
- High loads



HUS3-A  
(6)

- Small edge and spacing distance
- abZ (DIBt) approval for reusability in fresh concrete ( $f_{ck, cube} = 10/15/20$  Nmm<sup>2</sup>) for temporary applications



HUS3-P  
(6)

- Three embedment depths for maximum design flexibility



HUS3-PL  
(6)

- No cleaning required



HUS3-PS  
(6)

- HUS3-HF with multilayer coatings for additional corrosion protection



HUS3-I  
(6)

- Forged-on washer and hexagon head with no protruding thread



HUS3-I Flex  
(6)

- Through fastening

## Base material

## Load conditions



Concrete  
(non-cracked)



Concrete  
(cracked)

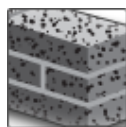

Solid brick



Autoclaved  
aerated  
concrete



Static /  
quasi-static



Seismic  
ETA-C1,C2



Fire  
resistance

## Installation conditions

## Other information

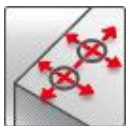

Small edge  
distance and  
spacing



European  
Technical  
Assessment



CE  
conformity



PROFIS  
Anchor design  
software



DIBt  
Approval  
Reusability

## Approvals / certificates

Description	Authority / Laboratory	No. / date of issue
European Technical Assessment	DIBt, Berlin	ETA-13/1038 / 22-07-2019
Fire test report	DIBt, Berlin	ETA-13/1038 / 22-07-2019

a) All data given in this section according ETA-13/1038 issue 22-07-2019.

### Static and quasi-static loading data (for a single anchor)

#### All data in this section applies to:

- Correct setting (See setting instruction)
- No edge distance and spacing influence
- Steel failure
- Minimum base material thickness
- Concrete C 20/25,  $f_{ck,cube} = 25 \text{ N/mm}^2$

#### Anchorage depth

Anchor size	6		8			10			14			
Type	HUS3-	H,C,A, I,I-flex	P,PS	H,C,HF			H,C,HF			H,HF		H
Nominal embedment depth $h_{nom}$ [mm]	$h_{nom1}$	$h_{nom2}$	$h_{nom1}$	$h_{nom2}$	$h_{nom3}$	$h_{nom1}$	$h_{nom2}$	$h_{nom3}$	$h_{nom1}$	$h_{nom2}$	$h_{nom3}$	
	55	55	50	60	70	55	75	85	65	85	115	

#### Characteristic resistance

Anchor size	6		8			10			14			
Type	HUS3-	H,C,A, I,I-flex	P,PS, PL	H,C,HF			H,C,HF			H,HF		H
<b>Non-cracked concrete</b>												
Tension $N_{Rk}$ [kN]	9,0	7,5	9,0	12,0	16,0	12,0	20,0	27,8	17,5	27,3	44,4	
Shear $V_{Rk}$ [kN]	12,5	12,5	12,8	19,0	22,0	13,5	30,0	34,0	35,0	54,5	62,0	
<b>Cracked concrete</b>												
Tension $N_{Rk}$ [kN]	6,0	6,0	6,0	9,0	12,0	9,7	16,2	19,8	12,5	19,4	31,7	
Shear $V_{Rk}$ [kN]	12,5	12,5	9,1	19,0	22,0	9,7	30,0	34,0	24,9	38,9	62,0	

#### Design resistance

Anchor size	6		8			10			14			
Type	HUS3-	H,C,A, I,I-flex	P,PS, PL	H,C,HF			H,C,HF			H,HF		H
<b>Non-cracked concrete</b>												
Tension $N_{Rd}$ [kN]	5,0	4,2	6,0	8,0	10,7	8,0	13,3	18,5	11,7	18,2	29,6	
Shear $V_{Rd}$ [kN]	8,3	8,3	8,5	12,7	14,7	9,0	20,0	22,7	23,3	36,3	41,3	
<b>Cracked concrete</b>												
Tension $N_{Rd}$ [kN]	3,3	3,3	4,0	6,0	8,0	6,4	10,8	13,2	8,3	13,0	21,1	
Shear $V_{Rd}$ [kN]	8,3	8,3	6,1	12,7	14,7	6,4	20,0	22,7	16,6	25,9	41,3	

#### Recommended loads<sup>a)</sup>

Anchor size	6		8			10			14			
Type	HUS3-	H,C,A, I,I-flex	P,PS, PL	H,C,HF			H,C,HF			H,HF		H
<b>Non-cracked concrete</b>												
Tension $N_{Rec}$ [kN]	3,6	3,0	4,3	5,7	7,6	5,7	9,5	13,2	8,3	13,0	21,2	
Shear $V_{Rec}$ [kN]	6,0	6,0	6,1	9,0	10,5	6,5	14,3	16,2	16,6	26,0	29,5	
<b>Cracked concrete</b>												
Tension $N_{Rec}$ [kN]	2,4	2,4	2,9	4,3	5,7	4,6	7,7	9,4	5,9	9,3	15,1	
Shear $V_{Rec}$ [kN]	6,0	6,0	4,3	9,0	10,5	4,6	14,3	16,2	11,9	18,5	29,5	

a) With overall partial safety factor for action  $\gamma = 1,4$ . The partial safety factors for action depend on the type of loading and shall be taken from national regulations.

## Seismic loading data (for single anchor)

### All data in this section applies to:

- Correct setting (See setting instruction)
- No edge distance and spacing influence
- Steel failure
- Minimum base material thickness
- Concrete C 20/25,  $f_{ck,cube} = 25 \text{ N/mm}^2$
- $\alpha_{gap} = 1,0$  (using Hilti seismic filling set)

### Anchorage depth for seismic C2

Anchor size			8	10	14
Type	HUS3 -		H	H	H
Nominal anchor. depth range	$h_{nom}$	[mm]	$h_{nom3}$	$h_{nom3}$	$h_{nom3}$
			70	85	115
Effective anchorage depth	$h_{eff}$	[mm]	54,9	67,1	91,8

### Characteristic resistance in case of seismic performance category C2

Anchor size			8	10	14
<b>with Hilti filling set (<math>\alpha_{gap} = 1,0</math>)</b>					
Type	HUS3 -		H, HF	H, HF	H, HF
Tension $N_{Rk,seis}$	[kN]		3,2	9,4	17,7
Shear $V_{Rk,seis}$	[kN]		14,7	25,6	46,6
<b>without Hilti filling set (<math>\alpha_{gap} = 0,5</math>)</b>					
Type	HUS3		H, HF	H, HF, C	H, HF
Tension $N_{Rk,seis}$	[kN]		3,2	9,4	17,7
Shear $V_{Rk,seis}$	[kN]		5,4	8,9	17,2

### Design resistance in case of seismic performance category C2

Anchor size			8	10	14
<b>with Hilti filling set (<math>\alpha_{gap} = 1,0</math>)</b>					
Type	HUS3 -		H, HF	H, HF	H, HF
Tension $N_{Rd,seis}$	[kN]		2,1	6,3	11,8
Shear $V_{Rd,seis}$	[kN]		9,8	17,1	31,1
<b>without Hilti filling set (<math>\alpha_{gap} = 0,5</math>)</b>					
Type	HUS3		H, HF	H, HF, C	H, HF
Tension $N_{Rd,seis}$	[kN]		2,1	6,3	11,8
Shear $V_{Rd,seis}$	[kN]		3,6	5,9	11,5

### Anchorage depth for seismic C1

Anchor size			8		10		14	
Type	HUS3-		H		H		H	
Nominal anchorage depth range	$h_{nom}$	[mm]	$h_{nom2}$	$h_{nom3}$	$h_{nom2}$	$h_{nom3}$	$h_{nom2}$	$h_{nom3}$
			60	70	75	85	85	115
Effective anchorage depth	$h_{ef}$	[mm]	46,4	54,9	58,6	67,1	66,3	91,8

**Characteristic resistance in case of seismic performance category C1**

Anchor size		8		10		14	
<b>with Hilti filling set (<math>\alpha_{\text{gap}} = 1,0</math>)</b>							
Type	HUS3 -	H, HF		H, HF		H, HF	H
Tension $N_{Rk,seis}$	[kN]	9,0	12,0	13,8	16,8	16,5	26,9
Shear $V_{Rk,seis}$	[kN]	11,9	11,9	16,8	17,7	22,5	34,5
<b>without Hilti filling set (<math>\alpha_{\text{gap}} = 0,5</math>)</b>							
Type	HUS3 -	H, HF		H, HF, C		H, HF	
Tension $N_{Rk,seis}$	[kN]	9,0	12,0	13,7	16,8	16,5	26,9
Shear $V_{Rk,seis}$	[kN]	6,0	6,0	8,4	8,9	11,3	17,3

**Design resistance in case of seismic performance category C1**

Anchor size		8		10		14	
<b>with Hilti filling set (<math>\alpha_{\text{gap}} = 1,0</math>)</b>							
Type	HUS3 -	H, HF		H, HF		H, HF	H
Tension $N_{Rd,seis}$	[kN]	6,0	8,0	9,2	11,2	11,0	17,9
Shear $V_{Rd,seis}$	[kN]	7,9	7,9	11,2	11,8	15,0	23,0
<b>without Hilti filling set (<math>\alpha_{\text{gap}} = 0,5</math>)</b>							
Type	HUS3 -	H, HF		H, HF, C		H, HF	
Tension $N_{Rd,seis}$	[kN]	6,0	8,0	9,1	11,2	11,0	17,9
Shear $V_{Rd,seis}$	[kN]	4,0	4,0	5,6	5,9	7,5	11,5

**Fire resistance**
**All data in this section applies to:**

- Correct setting (see setting instruction)
- No edge distance and spacing influence
- Minimum base material thickness
- For more fire resistance data please see the full ETA-13/1038 report.

**Recommended loads under fire exposure<sup>1)</sup>**

Anchor size		6					
Type	HUS3-	H	C	A	I / I-Flex	P	PS / PL
Nominal embedment depth	$h_{\text{nom}}$ [mm]	55					
<b>Steel failure for tension and shear load (<math>F_{\text{Rec,s,fi}} = N_{\text{Rec,s,fi}} = V_{\text{Rec,s,fi}}</math>)</b>							
Recommended tensile and shear load	R30	$F_{\text{Rec,s,fi}}$ [kN]	1,6				
	R120	$F_{\text{Rec,s,fi}}$ [kN]	0,7				
	R30	$M^0_{\text{Rec,s,fi}}$ [Nm]	1,4				
	R120	$M^0_{\text{Rec,s,fi}}$ [Nm]	0,6				
<b>Pull-out failure</b>							
Recommended resistance	R30 to R90	$N_{\text{Rec,p,fi}}$ [kN]	1,5				
	R120	$N_{\text{Rec,p,fi}}$ [kN]	1,2				
<b>Concrete cone failure</b>							
Edge distance <sup>2)</sup>	R30 to R120	$c_{\text{cr,fi}}$ [mm]	2 $h_{\text{ef}}$				
Spacing	R30 to R120	$s_{\text{cr,fi}}$ [mm]	2 $c_{\text{cr,fi}}$				
<b>Concrete pry-out failure</b>							
	R30 to R120	k [-]	1,5				
The anchorage depth has to be increased for wet concrete by at least 30 mm compared to the given value.							

- 1) The recommended loads under fire exposure include a safety factor for resistance under fire exposure  $\gamma_{\text{Ms,fire}} = 1,0$  and the partial safety factor for action  $\gamma_{\text{Ms,fire}} = 1,0$ . The partial safety factors for action shall be taken from national regulations, in this case it was taken the factor  $\gamma = 1,4$ .
- 2) In case of fire attack from more than one side, the minimum edge distance shall be  $\geq 300$  mm.

**Recommended loads under fire exposure<sup>1)</sup>**

Anchor size			8			10			14		
Type	HUS3-		H, HF			H, HF			H, HF		
Nominal embedment depth	$h_{nom}$	[mm]	$h_{nom1}$	$h_{nom2}$	$h_{nom3}$	$h_{nom1}$	$h_{nom2}$	$h_{nom3}$	$h_{nom1}$	$h_{nom2}$	$h_{nom3}$
			50	60	70	55	75	85	65	85	115
<b>Steel failure for tension and shear load (<math>F_{Rec,s,fi} = N_{Rec,s,fi} = V_{Rec,s,fi}</math>)</b>											
Recommended tensile and shear load	R30	$F_{Rec,s,fi}$ [kN]	3,2	3,5	3,8	6,1	6,2	10,4	10,6		
	R120	$F_{Rec,s,fi}$ [kN]	1,2	1,2	1,5	2,4	2,5	4,0	4,3		
	R30	$M^0_{Rec,s,fi}$ [Nm]	3,8	4,1	4,4	9,1	9,2	20,4	20,6		
	R120	$M^0_{Rec,s,fi}$ [Nm]	1,5	1,4	1,7	3,5	3,7	7,9	8,3		
<b>Pull-out failure</b>											
Recommended resistance	R30 to R90	$N_{Rec,p,fi}$ [kN]	1,5	2,3	3,0	2,4	4,0	4,9	3,1	4,8	7,8
	R120	$N_{Rec,p,fi}$ [kN]	1,2	1,8	2,4	1,9	3,2	3,9	2,5	3,8	6,3
<b>Concrete cone failure</b>											
Characteristic resistance	R30 to R90	$N^0_{Rec,p,fi}$ [kN]	1,8	2,6	4,0	2,0	4,7	6,6	3,0	6,4	14,4
	R120	$N^0_{Rec,p,fi}$ [kN]	1,4	2,1	3,2	1,6	3,8	5,3	2,4	5,1	11,5
Edge distance <sup>2)</sup>	R30 to R120	$c_{cr,fi}$ [mm]	2 $h_{ef}$								
Spacing	R30 to R120	$s_{cr,fi}$ [mm]	2 $c_{cr,fi}$								
<b>Concrete pry-out failure</b>											
	R30 to R120	k [-]	1,0	2,0	1,0	2,0					

The anchorage depth has to be increased for wet concrete by at least 30 mm compared to the given value.

1) The recommended loads under fire exposure include a safety factor for resistance under fire exposure  $\gamma_{Ms,fire} = 1,0$  and the partial safety factor for action  $\gamma_{Ms,fire} = 1,0$ . The partial safety factors for action shall be taken from national regulations, in this case it was taken the factor  $\gamma = 1,4$ .

**Recommended loads under fire exposure<sup>1)</sup>**

Anchor size			8			10		
Type	HUS3-		C			C		
Nominal embedment depth	$h_{nom}$	[mm]	$h_{nom1}$	$h_{nom2}$	$h_{nom3}$	$h_{nom1}$	$h_{nom2}$	$h_{nom3}$
			50	60	70	55	75	85
<b>Steel failure for tension and shear load (<math>F_{Rec,s,fi} = N_{Rec,s,fi} = V_{Rec,s,fi}</math>)</b>								
Recommended tensile and shear load	R30	$F_{Rec,s,fi}$ [kN]	0,5			1,2		
	R120	$F_{Rec,s,fi}$ [kN]	0,2			0,6		
	R30	$M^0_{Rec,s,fi}$ [Nm]	0,6			1,7		
	R120	$M^0_{Rec,s,fi}$ [Nm]	0,3			0,9		
<b>Pull-out failure</b>								
Recommended resistance	R30 to R90	$N_{Rec,p,fi}$ [kN]	1,5	2,3	3,0	2,4	4,0	5,0
	R120	$N_{Rec,p,fi}$ [kN]	1,2	1,8	2,4	1,9	3,2	4,0
<b>Concrete cone failure</b>								
Characteristic resistance	R30 to R90	$N^0_{Rec,p,fi}$ [kN]	1,8	2,6	4,0	2,0	4,7	6,6
	R120	$N^0_{Rec,p,fi}$ [kN]	1,5	2,1	3,2	1,6	3,8	5,3
Edge distance <sup>2)</sup>	R30 to R120	$c_{cr,fi}$ [m]	2 $h_{ef}$					
Spacing	R30 to R120	$s_{cr,fi}$ [m]	2 $c_{cr,fi}$					
<b>Concrete pry-out failure</b>								
	R30 to R120	k [-]	1,0	2,0	1,0	2,0		

The anchorage depth has to be increased for wet concrete by at least 30 mm compared to the given value.

2) In case of fire attack from more than one side, the minimum edge distance shall be  $\geq 300$  mm.

1) The recommended loads under fire exposure include a safety factor for resistance under fire exposure  $\gamma_{Ms,fire} = 1,0$  and the partial safety factor for action  $\gamma_{Ms,fire} = 1,0$ . The partial safety factors for action shall be taken from national regulations, in this case it was taken the factor  $\gamma = 1,4$ .

2) In case of fire attack from more than one side, the minimum edge distance shall be  $\geq 300$  mm.



## Materials

### Mechanical properties

Anchor size		6	8	10	14
Type	HUS3-	H,C,A,I, I-flex,P,PS,PL	H,C,HF	H,C,HF	H,HF
Nominal tensile strength $f_{uk}$	[N/mm <sup>2</sup> ]	930	810	805	730
Yield strength $f_{yk}$	[N/mm <sup>2</sup> ]	745	695	690	630
Stressed cross-section $A_s$	[mm <sup>2</sup> ]	26,9	48,4	77,0	131,7
Moment of resistance $W$	[mm <sup>3</sup> ]	19,6	47	95	213
Characteristic bending resistance $M^{0}_{RK,S}$	[Nm]	21	46	92	187

### Material quality

Type	Material
HUS3 - H,A,C,P,PS, PL,I,I-Flex	Carbon steel, galvanized
HUS3 - HF	Carbon steel, multi-layer coating <sup>a)</sup>

a) Multi-layer coating provides a higher corrosion resistance compared to regular hot dip galvanized (HDG) systems with a 40µm coating thickness.

### Head configuration

Type	Part		
HUS3-H HUS3-HF	Hexagonal head		
HUS3-C	Countersunk head		
HUS3-A	External thread		
HUS3-P	Pan head		
HUS3-PS	Pan head (small)		
HUS3-PL	Pan head (large)		
HUS3-I	Internal thread		
HUS3-I Flex	External thread		

### Anchor dimensions

Anchor size		6	8	10	14
Type	HUS3-	H,C,A,I, I-flex,P,PS,PL	H,C,HF	H,C,HF	H,HF
Threaded outer diameter	$d_t$ [mm]	7,85	10,30	12,40	16,85
Core diameter	$d_k$ [mm]	5,85	7,85	9,90	12,95
Shaft diameter	$d_s$ [mm]	6,15	8,45	10,55	13,80
Diameter of integrated washer	$d_i$ [mm]	16,50	17,50	20,50	29,0
Stressed section	$A_s$ [mm <sup>2</sup> ]	26,9	48,4	77,0	131,7

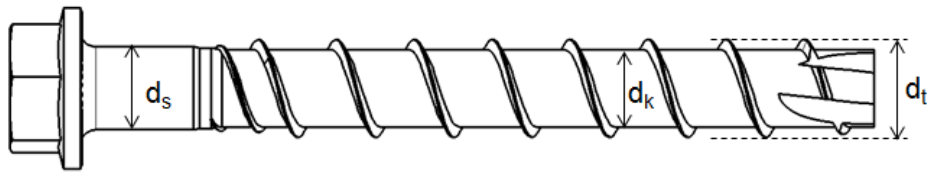

**HUS3:** Hilti Universal Screw 3<sup>rd</sup> generation

**H:** Hexagonal head

**10:** Screw diameter

**45/25/15:** Maximum thickness fixture  $t_{fix1}/t_{fix2}/t_{fix3}$  related to the embedment depth  $h_{nom1}/h_{nom2}/h_{nom3}$  (see Annex B3).

#### Screw length and thickness of fixture for HUS3<sup>1)</sup>

Anchor size		6					
Nominal embedment depth [mm]		$h_{nom1}$					
		55					
Type		H	C	A	I / I-Flex	P	PS / PL
Thickness of fixture		$t_{fix1}$	$t_{fix2}$	$t_{fix1}$	$t_{fix2}$	$t_{fix1}$	$t_{fix2}$
Length of screw [mm]	55	-	-	0	0	-	-
	60	5	5	-	-	5	5
	70	-	15	-	-	-	-
	80	25	-	-	-	25	-
	100	45	-	-	-	-	-
	120	65	-	-	-	-	-
	135	-	-	80	-	-	-
	155	-	-	100	-	-	-
	175	-	-	120	-	-	-
	195	-	-	140	-	-	-

1) Non-standard lengths, in the range  $55 \text{ mm} \leq L \leq 195 \text{ mm}$ , are also in the scope of this ETA.

#### Screw length and thickness of fixture for HUS3-C<sup>1)</sup>

Anchor size		8			10		
Nominal embedment depth [mm]		$h_{nom1}$	$h_{nom2}$	$h_{nom3}$	$h_{nom1}$	$h_{nom2}$	$h_{nom3}$
		50	60	70	55	75	85
Thickness of fixture		$t_{fix1}$	$t_{fix2}$	$t_{fix3}$	$t_{fix1}$	$t_{fix2}$	$t_{fix3}$
Length of screw [mm]	65	15	5	-	-	-	-
	70	-	-	-	15	-	-
	75	25	15	-	-	-	-
	85	35	25	15	-	-	-
	90	-	-	-	35	15	-
	100	-	-	-	45	25	15

1) Non-standard lengths, in the range  $65 \text{ mm} \leq L \leq 100 \text{ mm}$ , are also in the scope of this ETA.

**Screw length and thickness of fixture for HUS3-H and HUS3-HF<sup>1)</sup>**

Anchor size		8			10			14		
		$h_{nom1}$	$h_{nom2}$	$h_{nom3}$	$h_{nom1}$	$h_{nom2}$	$h_{nom3}$	$h_{nom1}$	$h_{nom2}$	$h_{nom3}$
Nominal embedment depth [mm]		50	60	70	55	75	85	65	85	115
Thickness of fixture		$t_{fix1}$	$t_{fix2}$	$t_{fix3}$	$t_{fix1}$	$t_{fix2}$	$t_{fix3}$	$t_{fix1}$	$t_{fix2}$	$t_{fix3}$
Length of screw [mm]	55	5	-	-	-	-	-	-	-	-
	60	-	-	-	5	-	-	-	-	-
	65	15	5	-	-	-	-	-	-	-
	70	-	-	-	15	-	-	-	-	-
	75	25	15	5	-	-	-	10	-	-
	80	-	-	-	25	5	-	-	-	-
	85	35	25	15	-	-	-	-	-	-
	90	-	-	-	35	15	5	-	-	-
	100	50	40	30	45	25	15	35	15	-
	110	-	-	-	55	35	25	-	-	-
	120	70	60	50	-	-	-	-	-	-
	130	-	-	-	75	55	45	65	45	15
150	100	90	80	95	75	65	85	65	35	

- 1) Non-standard lengths, in the range  $55 \text{ mm} \leq L \leq 150 \text{ mm}$ , are also in the scope of this ETA.  
 2) HUS3-HF available for size 14 with  $h_{nom1}$  and  $h_{nom2}$  only.

**Setting information**
**Setting details**

Anchor size			6					
Type	HUS3-		H	C	A	P, PS	I-Flex	PL
Nominal embedment depth [mm]			$h_{nom1}$					
			55					
Nominal diameter of drill bit	$d_0$	[mm]	6					
Cutting diameter of drill bit	$d_{cut} \leq$	[mm]	6,4					
Clearance hole diameter	$d_f \leq$	[mm]	9					10
Wrench size	SW	[mm]	13	-	13	-	13	-
Countersunk head diameter	$d_h$	[mm]	-	11,5	-			
Torx size	TX	-	-	30	-	30	-	30
Depth of drill hole in floor/wall position	$h_1 \geq$	[mm]	65					
Depth of drill hole (with adjustability setting process)	$h_1 \geq$	[mm]	58					
Installation Torque	$T_{inst}$	[Nm]	25					

### Setting details

Anchor size			8			10			14		
Type	HUS3-		H, HF, C			H, HF, C			H, HF		H
Nominal embedment depth	[mm]	$h_{nom1}$	$h_{nom2}$	$h_{nom3}$	$h_{nom1}$	$h_{nom2}$	$h_{nom3}$	$h_{nom1}$	$h_{nom2}$	$h_{nom3}$	
		50	60	70	55	75	85	65	85	115	
Nominal diameter of drill bit	$d_0$	[mm]	8			10			14		
Cutting diameter of drill bit	$d_{cut} \leq$	[mm]	8,45			10,45			14,50		
Clearance hole diameter	$d_f \leq$	[mm]	12			14			18		
Wrench size	SW	[mm]	13			15			21		
Countersunk head diameter	$d_h$	[mm]	18			21			-		
Torx size	TX	-	45			50			-		
Depth of drill hole in floor/wall position	$h_1 \geq$	[mm]	60	70	80	65	85	95	75	95	125
Depth of drill hole (with adjustability setting process)	$h_1 \geq$	[mm]	-	80	90	-	95	105	-		

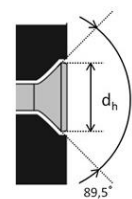
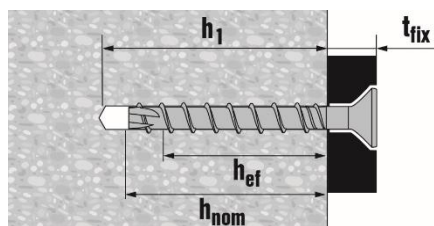
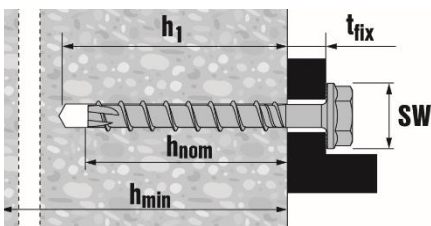

### Installation equipment

Anchor size	6	8	10	14
Type	HUS3- H,C,A,I, I-flex,P,PS,PL	H,C,HF	H,C,HF	H,HF
Rotary hammer	TE 2 - TE 7	TE 2 - TE 30		
Drill bit for concrete, solid clay brick and solid sand-lime brick	CX 6	CX 8	CX 10	CX 14
Drill bit for aerated concrete	CX 5	CX 6	CX 8	-
Socket wrench insert	S-NSD 13 1/2 L	SI-S 1/2" 13S	SI-S 1/2" 15S	SI-S 1/2" 21S
Torx	TX30	S-SY TX45	S-SY TX50	-
Tube for temporary application <sup>1)</sup>	-	HRG 8	HRG 10	HRG 14
Setting tool for cracked and un-cracked concrete	SIW 14 A SIW 22 A	SIW 14 A, SIW 22A, SIW 22 T-A	SIW 22 T-A SIW9	SIW 22 T-A SIW9
Setting tool for solid brick and aerated concrete	-	SFH 22 A		
Setting tool for hollow core slab	SIW 14 A SIW 22 A	SIW 22 A		

1) Only for HUS3-H

### Setting parameters

Anchor size		6	8			10			14		
Type	HUS3-										
Nominal embedment depth	$h_{nom}$ [mm]	55	50	60	70	55	75	85	65	85	115
Minimum base material thickness	$h_{min}$ [mm]	100	100	100	120	100	130	140	120	160	200
Minimum spacing	$s_{min}$ [mm]	35	50	50	50	50	50	50	60	60	60
			40 $c \geq 50$								
Minimum edge distance	$c_{min}$ [mm]	35	40	40	40	50	50	50	60	60	60
Critical spacing for splitting failure	$s_{cr,sp}$ [mm]	126	120	140	170	130	180	220	170	200	280
Critical edge distance for splitting failure	$c_{cr,sp}$ [mm]	63	60	70	85	65	90	110	85	100	140
Critical spacing for concrete cone failure	$s_{cr,N}$ [mm]	$3 h_{ef}$									
Critical edge distance for concrete cone failure	$c_{cr,N}$ [mm]	$1,5 h_{ef}$									

For spacing (edge distance) smaller than critical spacing (critical edge distance) the design loads have to be reduced (see system design resistance).

Critical spacing and critical edge distance for splitting failure apply only for non-cracked concrete. For cracked concrete only the critical spacing and critical edge distance for concrete cone failure are decisive.

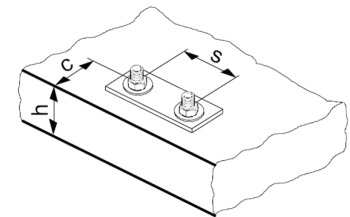

## Setting instructions

\*For detailed information on installation see instruction for use given with the package of the product

### Setting instruction with adjustment

1a. Hammer drilling (HD):  
Size 6 to 14

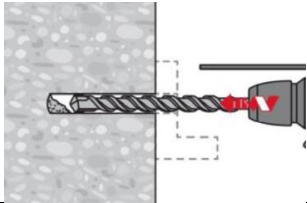

1b. Hammer drilling with Hilti hollow drill bit (HDB):  
Size 14 only. After drilling, proceed to fastener setting

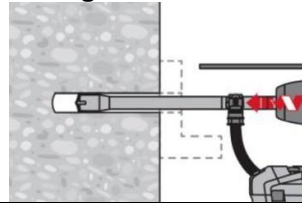

2. Cleaning

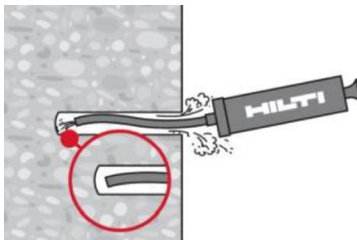

Clean the drill hole. For sizes 6 and 8, hole cleaning is not required when 3x ventilation after drilling is executed and one of the following conditions is fulfilled:

- drilling is in the vertical upwards orientation; or
- drilling is in vertical downwards direction and the drilling depth is increased by additional  $3 \cdot d_0$ .

For sizes 10 and 14, hole cleaning is not required when 3x ventilation after drilling is executed and one of the following conditions is fulfilled:

- drilling is in the vertical upwards orientation; or
- drilling is in vertical downwards or horizontal direction and the drilling depth is increased by additional  $3 \cdot d_0$ .

1) moving the drill bit in and out of the drill hole 3 times after the recommended drilling depth  $h_1$  is achieved. This procedure shall be done with both revolution and hammer functions activated in the drilling machine. For more details read the relevant MPII.

2) it should be verified that the thickness of the concrete member in which the fastener is installed observes the minimum distance between the drilling end and the opposite end of the member, fulfilling the relation  $h > h_1 + \Delta h$  with  $\Delta h = \max(2 \cdot d_0; 30 \text{ mm})$ .

3. Inserting the anchor by impact screw driver

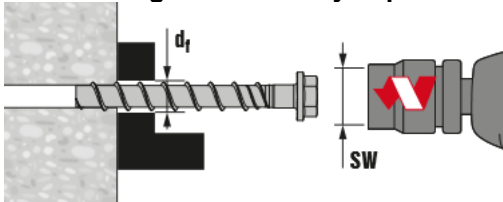

4. Anchor installed

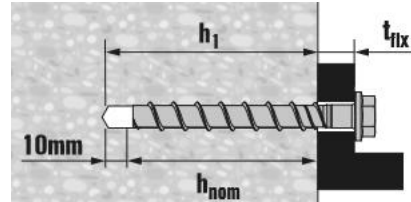

5. Checking

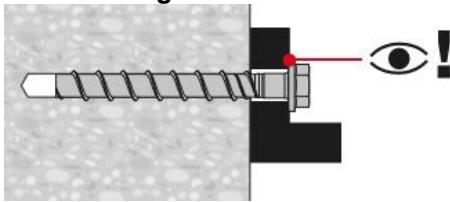

6. Adjusting the anchor by impact screw driver

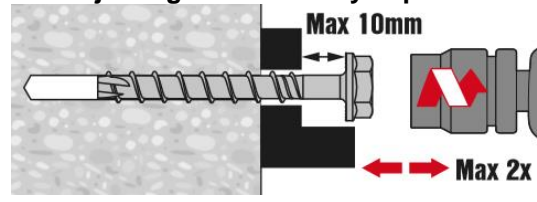

7. Checking

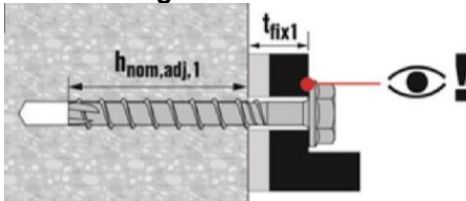

8. Adjusting the anchor by impact screw driver

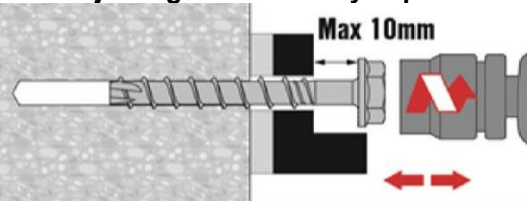

9. Checking

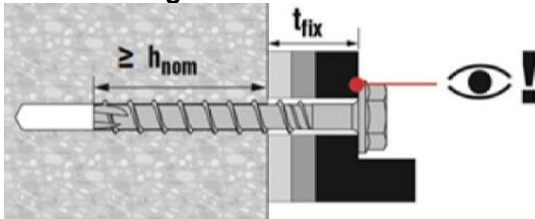

The anchor can be adjusted max. two times.

The total allowed thickness of shims added during the adjustment process is 10 mm.

The final embedment depth after adjustment process must be larger or equal than  $h_{nom2}$  or  $h_{nom3}$ .

For size 14 only, hole cleaning is not required under specific conditions. Check instructions for use for more information.

**Basic loading data for temporary application in standard and fresh concrete <28 days old,  $f_{ck,cube} \geq 10 \text{ N/mm}^2$**

**All data in this section applies to the following conditions:**

- Strength class,  $f_{ck,cube} \geq 10 \text{ N/mm}^2$
- Only temporary use
- Screw is reusable, before each usage it must be checked according to Hilti instruction for use with the suited tube Hilti HRG
- Design resistance and recommended loads are valid for single anchor only
- Design resistance as well as recommended loads are valid for all load directions and valid for both cracked and non-cracked concrete
- Minimum base material thickness
- No edge distance and spacing influence
- Valid for HUS3-H only
- All data in this section for sizes 10 and 14 according to DIBt approval Z-21.8.2018 issue 2014-04-01
- All data in this section for size 8 according to Hilti Technical Data

**Design resistance**

		Hilti Tech. Data			DIBt approval Z-21.8-2018					
Anchor size		8			10			14		
HUS3-H		8			10			14		
Nominal embedment depth	$h_{nom}$ [mm]	50	60	70	55	75	85	65	85	115
Cracked and non-cracked concrete										
Tensile $N_{rd}$ =	$f_{ck,cube} \geq 10 \text{ N/mm}^2$ [kN]	2,5	3,2	4,7	3,3	5,3	6,3	4,4	7,0	12,3
	$f_{ck,cube} \geq 15 \text{ N/mm}^2$ [kN]	3,1	4,0	5,7	4,0	6,4	7,8	5,4	8,5	15,0
Shear $V_{rd}$	$f_{ck,cube} \geq 20 \text{ N/mm}^2$ [kN]	3,6	4,6	6,6	4,7	7,4	9,0	6,2	9,9	17,3

**Recommended load <sup>a)</sup>**

		Hilti Tech. Data			DIBt approval Z-21.8-2018					
Anchor size		8			10			14		
HUS3-H		8			10			14		
Nominal embedment depth	$h_{nom}$ [mm]	50	60	70	55	75	85	65	85	115
Tensile $N_{rec}$ =	$f_{ck,cube} \geq 10 \text{ N/mm}^2$ [kN]	1,8	2,3	3,4	2,4	3,8	4,5	3,1	5,0	8,8
	$f_{ck,cube} \geq 15 \text{ N/mm}^2$ [kN]	2,2	2,9	4,1	2,9	4,6	5,5	3,8	6,1	10,7
Shear $V_{rec}$	$f_{ck,cube} \geq 20 \text{ N/mm}^2$ [kN]	2,6	3,3	4,7	3,3	5,3	6,4	4,4	7,1	12,4

a) With overall partial safety factor for action  $\gamma = 1,4$ . The partial safety factors for action depend on the type of loading and shall be taken from national regulations.



## Setting information

### Setting details

		Hilti			DIBt approval Z-21.8-2018					
Anchor size	HUS3-H	8			10			14		
Nominal anchorage depth	$h_{nom}$ [mm]	50	60	70	55	75	85	65	85	115
Minimum base material thickness	$h_{min}$ [mm]	100	115	145	115	150	175	130	175	255
Minimum spacing	$s_{min}$ [mm]	180	225	285	225	300	345	255	345	510
Minimum edge distance direction 1	$c_1$ [mm]	60	75	95	75	100	115	85	115	170
Minimum edge distance direction 2	$c_2$ [mm]	95	115	145	115	150	175	130	180	260

### Setting parameters

		Hilti			DIBt approval Z-21.8-2018					
Anchor size	HUS3-H	8			10			14		
Nominal anchorage depth	$h_{nom}$ [mm]	50	60	70	55	75	85	65	85	115
Nominal diameter of drill bit	$d_o$ [mm]	8			10			14		
Cutting diameter of drill bit	$d_{cut} \leq$ [mm]	8,45			10,45			14,50		
Depth of drill bit	$h_1 \leq$ [mm]	60	70	80	65	85	95	75	95	125
Diameter of clearance hole in the fixture	$d_f \leq$ [mm]	12			14			18		
Width across	SW [mm]	13			15			21		
Impact screw driver		Hilti SIW 22 T-A								
Suited tube		Hilti HRG 8			Hilti HRG 10			Hilti HRG 14		

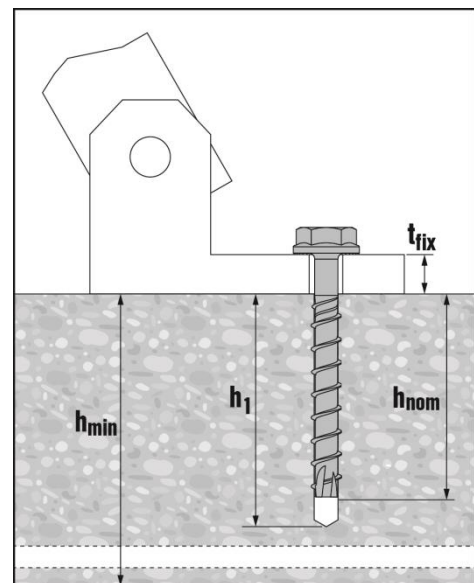
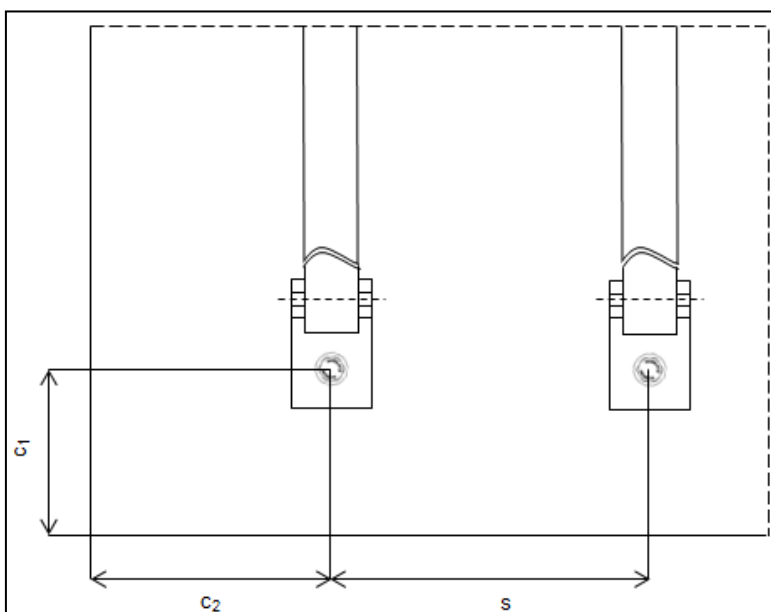

### Tube specification

Anchor size / tube		8 / HRG 8	10 / HRG 10	14 / HRG 14
Inner tube diameter	$\varnothing_i$ [mm]	9,7	11,7	16,0
Outer tube diameter	$\varnothing_e$ [mm]	15,0	17,0	22,0
Tube length	Lt [mm]	23,0	28,0	40,3

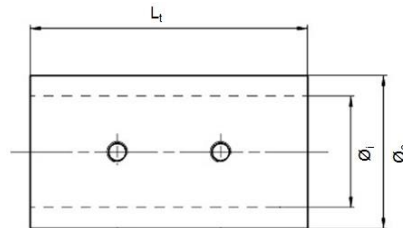

### Setting instructions

\*For detailed information on installation see instruction for use given with the package of the product

Instruction for use – re-use of screw	
<p><b>1. Removing the anchor with Screw-driver</b></p>	<p><b>2. Removing the anchor</b></p>
<p><b>3. Checking with tube Hilti HRG</b></p>	<p><b>4. Checking with tube Hilti HRG</b></p>
<p><b>5. Drilling</b></p>	<p><b>6. Reinstall based on setting instructions</b></p>

## Basic loading data (for a single anchor) in solid masonry units



### All data in this section applies to:

- Load values valid for holes drilled with TE rotary hammers in hammering mod
- Correct anchor setting (see instruction for use, setting details)
- The core/material ratio may not exceed 15 % of a bed joint area
- The brim area around holes must be at least 70mm
- Edge distances, spacing and other influences, see below
- All data given in this section according to Hilti Technical Data

### Nominal embedment depth

Anchor size		6	8	10
Nominal embedment depth	$h_{nom}$ [mm]	55	60	75

### Recommended loads for HUS3

Anchor size			6	8	10
			A, H, I, C, P, PS, PL	H, C, HF	H, C, HF
		Compressive strength class [N/mm <sup>2</sup> ]	$F_{rec}$ Tensile and shear loads		
	Solid clay brick Mz 12/2,0	≥ 8	0,6	-	-
		≥ 10	0,7	-	-
		≥ 12	0,8	1,1	1,4
	DIN 105 / EN 771-1	≥ 16	0,9	-	-
		≥ 20	0,9	1,6	2,0
	Solid sand-lime brick Mz 12/2,0	≥ 8	0,8	-	-
		≥ 10	0,9	-	-
		≥ 12	1,0	1,3	1,4
	DIN 106/EN 771-2	≥ 16	1,1	-	-
		≥ 20	1,2	1,7	2,1
	Aerated concrete PPW 6-0,4 DIN 4165/EN 771-4	≥ 6	0,4	0,7	0,9

## Permissible anchor location in brick and block walls

### Edge distance and spacing influence

- The technical data for HUS3 anchors are reference loads for MZ 12, KS 12 and PPW 6. Due to the large variation of natural stone slid bricks, on site anchor testing is recommended to validate technical data
- The HUS3 anchor was installed and tested in center of solid bricks as shown. The HUS3 anchor was not tested in the mortar joint between solid bricks or in hollow bricks, however a load reduction is expected
- For brick walls where anchor position in brick can not be determined, 100 % anchor testing is recommended
- Distance to free edge free edge to solid masonry (Mz and KS) units ≥ 200mm
- Distance to free edge free edge to solid masonry (autoclaved aerated gas concrete) units ≥ 170mm
- The minimum distance to horizontal and vertical mortar joint ( $c_{min}$ ) is started in drawing below
- Minimum anchor spacing ( $s_{min}$ ) in one brick/block is ≥ 80 mm

### Limits

- All data is for multiple use for non-structural applications
- Plaster, graveling, lining or levelling courses are regarded as non-bearing and may not be taken into account for the calculation of embedment depth
- The decisive resistance to tension loads is the lower value of  $N_{rec}$  (brick breakout, pull out) and  $N_{max,pb}$  (pull out of one brick)

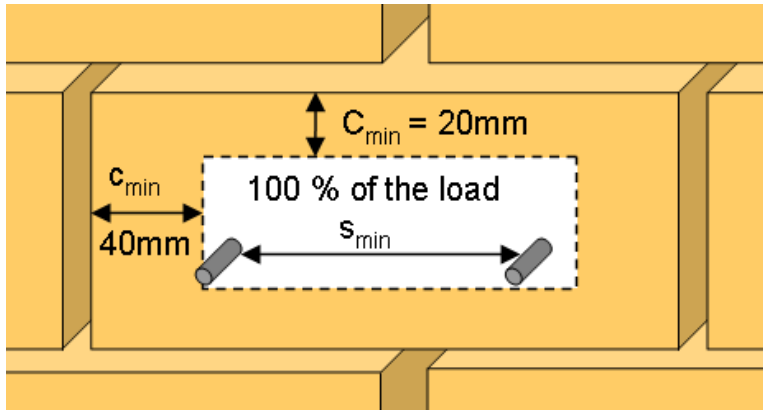

### Basic loading data for single anchor in Hollow core slab

#### All data in this section applies to

- Correct setting (See setting instruction)
- No edge distance and spacing influence
- Ratio core width / web thickness  $w/e \leq 4,2$
- Concrete C 30/37 to C 50/60

#### Characteristic resistance

Anchor size			8	10
Type	HUS3		C, H, HF	C, H, HF
Bottom flange thickness	$d_b \geq$	[mm]	30	30
All load directions	$F_{Rk}$	[kN]	2,0	2,0

#### Design resistance

Anchor size			8	10
Type	HUS3		C, H, HF	C, H, HF
Bottom flange thickness	$d_b \geq$	[mm]	30	30
All load directions	$F_{Rd}$	[kN]	1,3	1,3

#### Recommended loads

Anchor size			8	10
Type	HUS3		C, H, HF	C, H, HF
Bottom flange thickness	$d_b \geq$	[mm]	30	30
All load directions <sup>a)</sup>	$F_{rec}$	[kN]	0,95	0,95

- a) With overall partial safety factor for action  $\gamma = 1,4$ . The partial safety factors for action depend on the type of loading and shall be taken from national regulations.

Anchor Type	Size [mm]	Length [mm]	$d_b=30$ [mm]		$d_b=35$ [mm]		$d_b=40$ [mm]		$d_b=50$ [mm]	
			$t_{fix,min}$ [mm]	$t_{fix,max}$ [mm]	$t_{fix,min}$ [mm]	$t_{fix,max}$ [mm]	$t_{fix,min}$ [mm]	$t_{fix,max}$ [mm]	$t_{fix,min}$ [mm]	$t_{fix,max}$ [mm]
HUS3-H	8	55	5	15	5	10	5	5	5	5
		65	5	25	5	20	5	15	5	5
		75	5	35	5	30	5	25	5	15
		85	15	45	15	40	15	35	15	25
		100	30	60	30	55	30	50	30	40
		120	50	80	50	75	50	70	50	60
		150	80	110	80	105	80	100	80	90
HUS3-HF	8	65	5	25	5	20	5	15	5	5
		75	5	35	5	30	5	25	5	15
		85	15	45	15	40	15	35	15	25
		100	30	60	30	55	30	50	30	40
HUS3-C	8	65	15	25	15	20	15	15	15	5
		75	15	35	15	30	15	25	15	15
		85	15	45	15	40	15	35	15	25
HUS3-H	10	60	5	15	5	10	5	5	5	5
		70	15	25	15	20	15	15	15	5
		80	5	35	5	30	5	25	5	15
		90	5	45	5	40	5	35	5	25
		100	15	55	15	50	15	45	15	35
		110	25	65	25	60	25	55	25	45
		130	45	85	45	80	45	75	45	65
		150	65	105	65	100	65	95	65	85
HUS3-HF	10	60	5	15	5	10	5	5	5	5
		80	5	35	5	30	5	25	5	15
		100	15	55	15	50	15	45	15	35
		110	25	65	25	60	25	55	25	45
HUS3-C	10	70	15	25	15	20	15	15	15	10
		90	15	45	15	40	15	35	15	25
		100	15	55	15	50	15	45	15	35

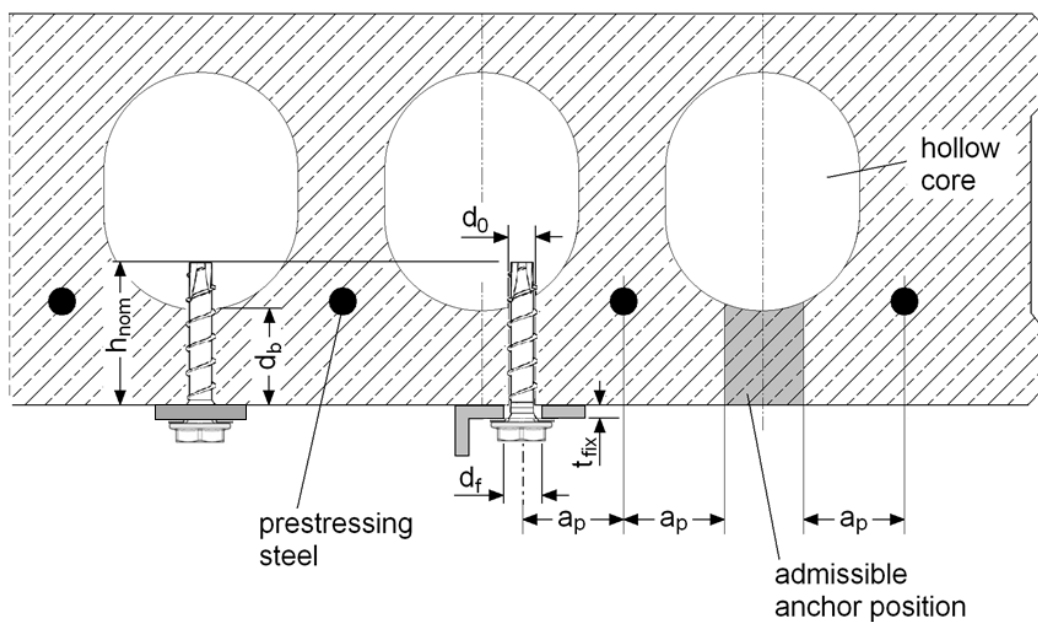

### Anchor spacing and edge distance

Anchor size		8	10
Type	HUS3	C, H, HF	C, H, HF
Minimum edge distance	$c_{min} \geq$ [mm]	100	
Minimum anchor spacing	$s_{min} \geq$ [mm]	100	
Minimum distance between anchor groups	$a_{min} \geq$ [mm]	100	

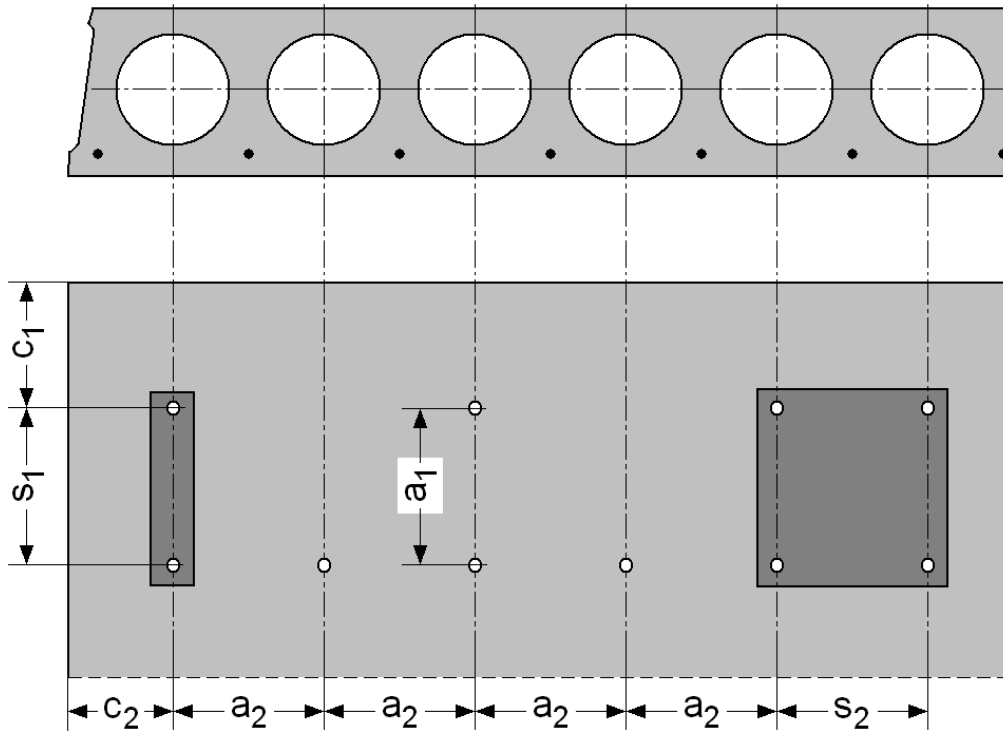

## Setting instructions

\*For detailed information on installation see instruction for use given with the package of the product

### Installation in hollow core slabs

#### 1. Checking the anchor with tube Hilti HSB

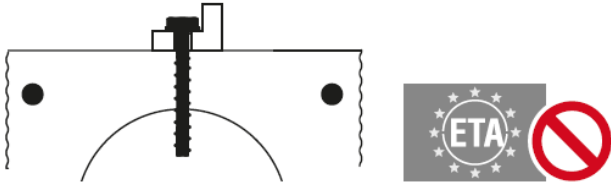

#### 2. Positioning pre-stressed steel

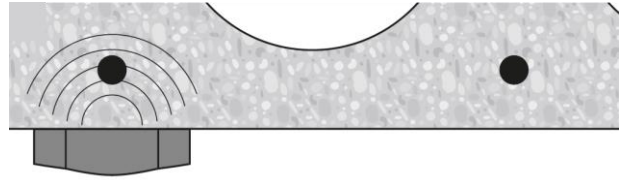

#### 3. Marking pre-stressed steel position

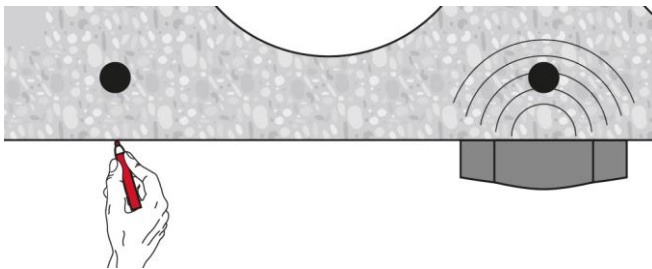

#### 4. Marking pre-stressed steel position

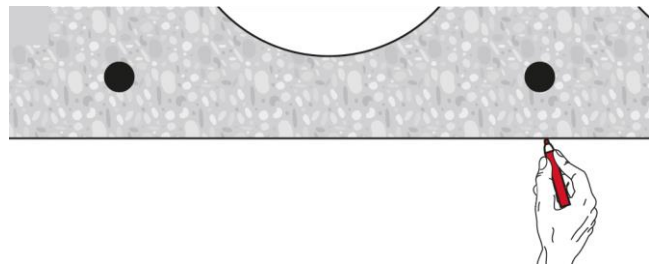

#### 5. Drilling

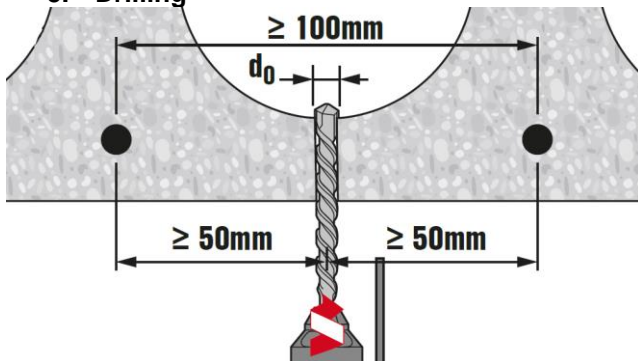

#### 6. Setting the anchor

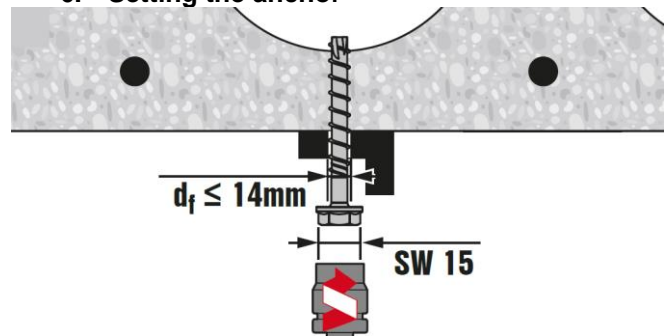

#### 7. Setting the anchor

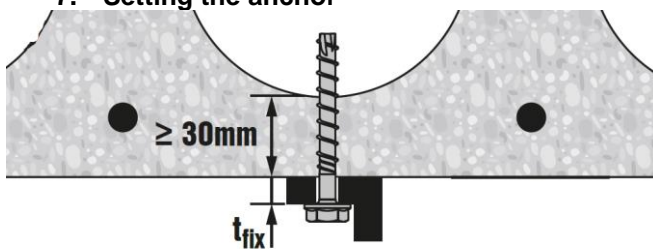

#### 8. Checking

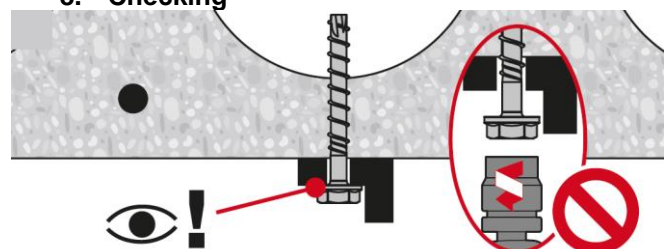





Chemical anchors

Screw

Mechanical anchors

Plastic/Light duty metal anchors

Insulation anchors

# HUS3, HUS-HR / HUS-CR Screw anchor

Ultimate performance screw anchor for redundant fastening applications











Chemical anchors





Screw

Mechanical anchors

Plastic/Light duty metal anchors

Insulation anchors

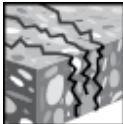
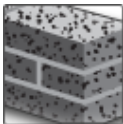
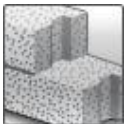
Anchor version	Benefits
 HUS3-H/HF (6-10)	<ul style="list-style-type: none"> <li>- Quick and easy setting</li> <li>- Low expansion forces in base materials</li> <li>- Removable</li> <li>- Forged-on washer and hexagon head with no protruding thread</li> <li>- ETA approval for cracked and non cracked concrete and for hollow core slabs</li> <li>- High productivity – less drilling and fewer operations than with conventional anchors</li> <li>- Through-fastening and pre-setting (based on the head configuration)</li> </ul>
 HUS-HR (6)	
 HUS3-C (6-10)	
 HUS-CR (6)	
 HUS3-A (6)	
 HUS3-PL (6)	
 HUS3-P (6)	
 HUS3-PS (6)	
 HUS3-I (6)	
 HUS3-I Flex (6)	

Base material	Load conditions
 Concrete (non-cracked)	 Static / quasi-static  Fire resistance
 Concrete (cracked)	
 Solid brick	
 Autoclaved aerated concrete	
 Prestressed hollow core slabs	

Installation conditions	Other information
 Small edge distance and spacing	 European Technical Assessment  CE conformity  Corrosion resistance

### Approvals / certificates

Description	Authority / Laboratory	No. / date of issue
European Technical Assessment	DIBt, Berlin	ETA-10/0005 / 2018-11-12
Fire test report	DIBt, Berlin	ETA-10/0005 / 2018-11-12

a) All data given in this section according ETA-10/0005 issue 2018-11-12

### Basic loading data (for a single anchor)

All data in this section applies to:

- Correct setting (See setting instruction)
- No edge distance and spacing influence
- Concrete C 20/25,  $f_{ck,cube} = 25 \text{ N/mm}^2$

### Anchorage depth

Type		HUS <sup>1)</sup>	HUS <sup>2)</sup>	HUS <sup>3)</sup>
		HR, CR	HR,CR	H,P,PS,I,I-Flex,A,C
Nominal embedmt.depth	$h_{nom}$ [mm]	30	35	35

1) Hilti Technical Data for embedment depth of 30 mm

2) ETA-10/0005 issue 2018-11-12

### Characteristic resistance for all loads directions

Type		HUS <sup>1)</sup>	HUS <sup>2)</sup>		HUS <sup>3)</sup>
		HR,CR	HR,CR	HR,CR	H,PL,P,PS,I,I-Flex,A,C
Fastener size		6 all lengths	6x40 6x45	6x60 6x70	6 all lengths
$35 \text{ mm} \leq c < 80 \text{ mm}$	$F_{Rk}^0$ [kN]	2	3		2
$c > 80 \text{ mm}$	$F_{Rk}^0$ [kN]	2	3,5	5	3

1) Hilti Technical Data for embedment depth of 30 mm

2) ETA-10/0005 issue 2018-11-12

### Design resistance for all loads directions

Type		HUS <sup>1)</sup>	HUS <sup>2)</sup>		HUS <sup>3)</sup>
		HR,CR	HR	CR	H,PL,P,PS,I,I-Flex,A,C
Fastener size		6 all lengths	6x40 6x45	6x60 6x70	6 all lengths
$35 \text{ mm} \leq c < 80 \text{ mm}$	$F_{Rd}^0$ [kN]	1	1,4		1,3
$c > 80 \text{ mm}$	$F_{Rd}^0$ [kN]	1	1,7	2,4	2,0

1) Hilti Technical Data for embedment depth of 30 mm

2) ETA-10/0005 issue 2018-11-12

### Recommended loads for all load directions

Type		HUS <sup>1)</sup>	HUS <sup>2)</sup>		HUS <sup>3)</sup>
		HR,CR	HR	CR	H,PL,P,PS,I,I-Flex,A,C
Fastener size		6 all lengths	6x40 6x45	6x60 6x70	6 all lengths
$35 \text{ mm} \leq c < 80 \text{ mm}$	$F_{Rec}^0$ [kN]	0,7	1,0		0,9
$c > 80 \text{ mm}$	$F_{Rec}^0$ [kN]	0,7	1,2	1,7	1,4

1) Hilti Technical Data for embedment depth of 30 mm

2) ETA-10/0005 issue 2018-11-12

3) With overall partial safety factor for action  $\gamma = 1,4$ . The partial safety factors for action depend on the type of loading and shall be taken from national regulations

## Requirements for redundant fastening

The definition of redundant fastening according to Member States is given in the EAD 330747 § 1.2.1. In Absence of a definition by a Member State the following default values may be taken.

Minimum number of fixing points	Minimum number of anchors per fixing point	Maximum design load of action $N_{Sd}$ per fixing point <sup>a)</sup>
3	1	2 kN
4	1	3 kN

a) The value for maximum design load of actions per fastening point  $N_{Sd}$  is valid in general that means all fastening points are considered in the design of the redundant structural system. The value  $N_{Sd}$  may be increased if the failure of one (=most unfavourable) fixing point is taken into account in the design (serviceability and ultimate limit state) of the structural system e.g. suspended ceiling.

## Materials

### Mechanical properties

Type		HUS	HUS3
		HR,CR	H,PL,P,PS,I,I-Flex,A,C
Nominal tensile strength $f_{uk}$	[N/mm <sup>2</sup> ]	1040	930
Stressed cross-section $A_s$	[mm <sup>2</sup> ]	22,9	26,9
Moment of resistance $W$	[mm <sup>3</sup> ]	15,5	19,7
Design bending resistance $M^0_{Rd,s}$	[Nm]	12,9	14,6

### Material quality

Type	Material
HUS3- H,A,C,P,PS,I,I-Flex	Carbon steel, galvanized $\geq 5 \mu\text{m}$
HUS- HR,CR	Stainless steel, grade A4

### Anchor dimensions

Type		HUS	HUS3								
		HR,CR	H	C	A	PL	P	PS	I	I-Flex	
Nominal length	$l_s$ [mm]	40-70	40-120	40-70	35-55	60	40-80	40-60	35-55	55-195	
Threaded outer diameter	$d_t$ [mm]	7,6		7,85							
Core diameter	$d_k$ [mm]	5,4		5,85							
Shaft diameter	$d_s$ [mm]	5,8		6,15							
Diameter of integrated washer	$d_i$ [mm]	-	16,5	-	-		-	-	-	-	
Stressed section	$A_s$ [mm <sup>2</sup> ]	22,9		26,9							

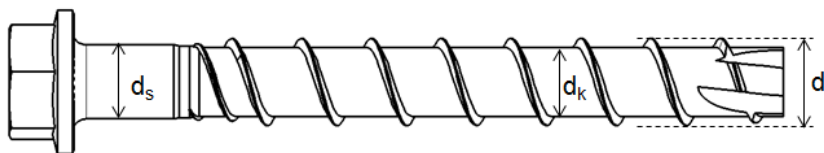

### Special anchor dimensions

Type	HUS3-C			HUS-CR			HUS3-			
	M6	M8	M10	M6	M8	M10	PL	P	PS	
Countersunk height	$h_c$ [mm]	4,0	6,3	6,9	4,3	6,3	7,0	-	-	-
Diameter of the countersunk	$d_c$ [mm]	11,5	18	21	11,5	18	21	-	-	-
Pan head diameter	$d_p$ [mm]	-	-	-	-	-	-	21,8	17,6	13,3

### Head configuration

Type	Head		
HUS3-H 6	Hexagonal head		
HUS-HR 6	Hexagonal head		
HUS3-C 6	Countersunk head		
HUS-CR 6	Countersunk head		
HUS3-A 6	External thread		
HUS3-PL	Pan head (large)		
HUS3-P	Pan head		
HUS3-PS 6	Pan head (small)		
HUS3-I 6	Internal thread		
HUS3-I Flex 6	External thread		

## Setting information

### Setting details

Type		[mm]	HUS		HUS3						
			HR	CR	H	C	A	P	PL	PS	I
Nominal diameter of drill bit	$d_0$	[mm]	6								
Cutting diameter of drill bit	$d_{cut} \leq$	[mm]	6,40								
Clearance hole diameter	$d_f$	[mm]	9								
Wrench size	SW	[mm]	13	-	13	-	13	-	-	13	13
Installation torque	$T_{inst}$	[mm]	- <sup>1)</sup>	- <sup>1)</sup>	18						
Depth of drill hole in floor/wall position	$h_1 \geq$	[mm]	45 mm								
Depth of drill hole in ceiling position	$h_1 \geq$	[mm]	38 mm								

1) Hand setting in concrete base material not allowed (machine setting only).

### Setting parameters

Type		[mm]	HUS-HR, CR HUS3-H, PL, P, PS, I, I-Flex, A, C
Minimum base material	$h_{min}$	[mm]	80
Minimum spacing	$s_{min}$	[mm]	35
Minimum edge distance	$c_{min}$	[mm]	35(80) <sup>1)</sup>
Critical spacing	$s_{cr}$	[mm]	3 $h_{ef}$
Critical edge distance	$c_{cr}$	[mm]	1,5 $h_{ef}$

1) For spacing (edge distance) smaller than critical spacing (critical edge distance) the design loads have to be reduced (see system design resistance).

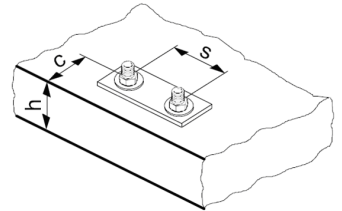

### Screw length and maximum thickness of fixture

Fastener size		6									
Type		HUS		HUS3							
		HR	CR	H	C	A	PL	P	PS	I	I-
Length of screw [mm]	Nominal embedment depth [mm]	$h_{nom}$									
		Thickness of fixture [mm] $t_{fix}$									
	35	-	-	-	-	0	-	-	-	0	-
	40	-	5	5	5	-	-	5	5	-	-
	45	10	-	-	-	-	-	-	-	-	-
	55	-	-	-	-	20	-	-	-	20	20
	60	25	25	25	25	-	25	25	25	-	-
	70	35	35	-	35	-	-	-	-	-	-
	80	-	-	45	-	-	-	45	-	-	-
	100	-	-	65	-	-	-	-	-	-	-
	120	-	-	85	-	-	-	-	-	-	-
	135	-	-	-	-	-	-	-	-	-	100
	155	-	-	-	-	-	-	-	-	-	120
	175	-	-	-	-	-	-	-	-	-	140
	195	-	-	-	-	-	-	-	-	-	160

### Installation equipment

Type		HUS		HUS3								
		HR	CR	H	C	A	PL	P	PS	I	I-Flex	
Torx size	TX	-	-	T30	T30	T30	-	T30	T30	T30	-	-
Rotary hammer		TE 6 – TE 7										
Drill bit		TE-CX 6										
Wrench size (H, A, I-type)	SW	[mm]	13	-	13	-	13	-	-	-	13	13
Socket wrench insert (H, A, I-type)			S-NSD 13 ½ (L)									
Impact screw driver	$T_{inst}$	[mm]	Hilti SIW 14-A /Hilti SIW 22-A									

### Setting parameters

Type			HUS-HR, CR HUS3-H, PL, P, PS, I, I-Flex, A, C									
Minimum base material	$h_{min}$	[mm]	80									
Minimum spacing	$s_{min}$	[mm]	35									
Minimum edge distance	$c_{min}$	[mm]	35(80) <sup>1)</sup>									
Critical spacing	$s_{cr}$	[mm]	3 $h_{ef}$									
Critical edge distance	$c_{cr}$	[mm]	1,5 $h_{ef}$									

2) For spacing (edge distance) smaller than critical spacing (critical edge distance) the design loads have to be reduced (see system design resistance).

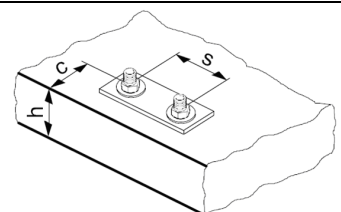



## Setting instructions

\*For detailed information on installation see instruction for use given with the package of the product

### Setting instruction for HUS-HR,CR

#### 1. Drill hole with the drill bit

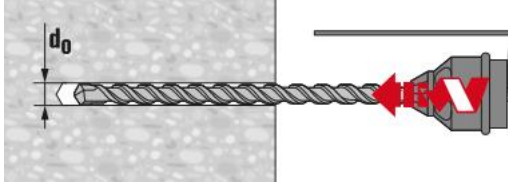

#### 2. Clean hole

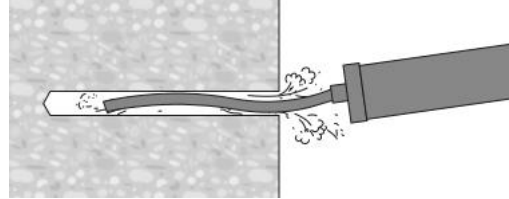

#### 3. Installing the anchor by impact screw driver

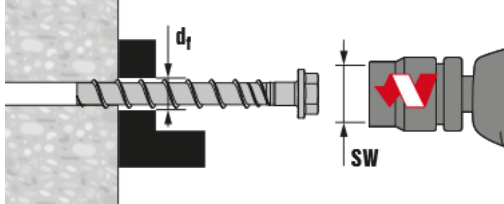

#### 4. Checking

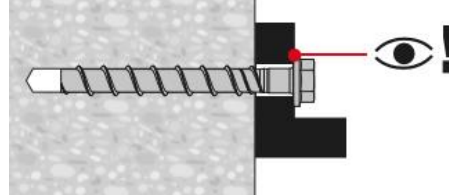

### Setting instruction for HUS3-H, C, I, I-Flex, A, P, PS

#### 1. Drill hole with drill bit

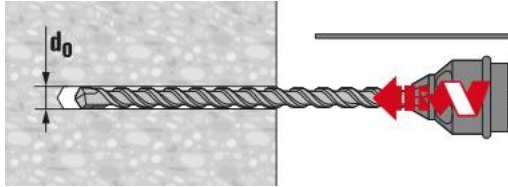

#### 2. Clean hole

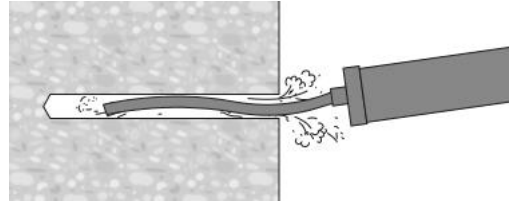

#### 3. Installing the anchor by impact screw driver

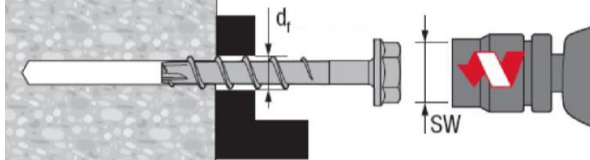

#### 4. Checking

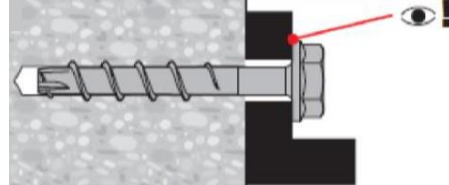

The anchor can be adjusted max. two times.

The total allowed thickness of shims added during the adjustment process is 10 mm.

The final embedment depth after adjustment process must be larger or equal than  $h_{nom2}$  or  $h_{nom3}$ .

## Basic loading data for redundant fastening in prestressed hollow core slabs

### All data in this section applies to:

- Correct anchor setting (See setting instruction)
- No edge distance and spacing influence
- Ratio core width/web thickness  $w/e \leq 4,2$
- Concrete C 30/37 to C50/56
- Data for size 6 is according to ETA-10/0005
- Data for size 8 and 10 is according to Hilti technical data

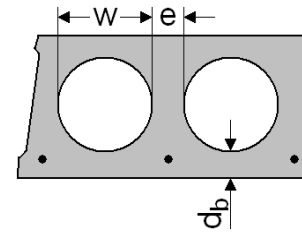

### Requirements for redundant fastening

The definition of redundant fastening according to Member States is given in the EAD 330747 § 1.2.1. In Absence of a definition by a Member State the following default values may be taken.

Minimum number of fixing points	Minimum number of anchors per fixing point	Maximum design load of action $N_{sd}$ per fixing point <sup>a)</sup>
3	1	2 kN
4	1	3 kN

- a) The value for maximum design load of actions per fastening point  $N_{sd}$  is valid in general that means all fastening points are considered in the design of the redundant structural system. The value  $N_{sd}$  may be increased if the failure of one (=most unfavourable) fixing point is taken into account in the design (serviceability and ultimate limit state) of the structural system e.g. suspended ceiling.

### Characteristic resistance for all load directions

Type		HUS-HR,CR 6x40, 6x45		HUS-HR, CR 6x60, 6x70			HUS3-H, PL, P, PS, I, I-Flex, A, C 6 all lengths		
		$\geq 25$	$\geq 30$	$\geq 25$	$\geq 30$	$\geq 35$	$\geq 25$	$\geq 30$	$\geq 35$
Bottom flange thickness	$d_b$ [mm]	$\geq 25$	$\geq 30$	$\geq 25$	$\geq 30$	$\geq 35$	$\geq 25$	$\geq 30$	$\geq 35$
All load directions	$F_{Rk}$ [kN]	1,0	2,0	1,0	2,0	3,0	1,0	2,0	3,0

### Design resistance for all load directions

Type		HUS-HR,CR 6x40, 6x45		HUS-HR, CR 6x60, 6x70			HUS3-H, PL, P, PS, I, I-Flex, A, C 6 all lengths		
		$\geq 25$	$\geq 30$	$\geq 25$	$\geq 30$	$\geq 35$	$\geq 25$	$\geq 30$	$\geq 35$
Bottom flange thickness	$d_b$ [mm]	$\geq 25$	$\geq 30$	$\geq 25$	$\geq 30$	$\geq 35$	$\geq 25$	$\geq 30$	$\geq 35$
All load directions	$F_{Rd}$ [kN]	0,7	1,3	0,7	1,3	2,0	0,7	1,3	2,0

### Recommended load for all load directions<sup>a)</sup>

Type		HUS-HR,CR 6x40, 6x45		HUS-HR, CR 6x60, 6x70			HUS3-H, PL, P, PS, I, I-Flex, A, C 6 all lengths		
		$\geq 25$	$\geq 30$	$\geq 25$	$\geq 30$	$\geq 35$	$\geq 25$	$\geq 30$	$\geq 35$
Bottom flange thickness	$d_b$ [mm]	$\geq 25$	$\geq 30$	$\geq 25$	$\geq 30$	$\geq 35$	$\geq 25$	$\geq 30$	$\geq 35$
All load directions	$F_{Rec}$ [kN]	0,5	1,0	0,5	1,0	1,4	0,5	1,0	1,4

- a) With overall partial safety factor for action  $\gamma = 1,4$ . The partial safety factors for action depend on the type of loading and shall be taken from national regulations.

### Characteristic resistance for all load directions

Anchor size		8	10
Type		HUS3-C, H, HF	
Bottom flange thickness	$d_b \geq$ [mm]	30	30
All load directions	$F_{Rk}$ [kN]	2,0	2,0

### Design resistance for all load directions

Anchor size		8	10
Type		HUS3-C, H, HF	
Bottom flange thickness	$d_b \geq$ [mm]	30	30
All load directions	$F_{Rd}$ [kN]	1,3	1,3

### Recommended loads for all load directions

Anchor size		8	10
Type		HUS3-C, H, HF	
Bottom flange thickness	$d_b \geq$ [mm]	30	30
All load directions <sup>a)</sup>	$F_{Rec}$ [kN]	0,95	0,95

a) With overall partial safety factor for action  $\gamma = 1,4$ . The partial safety factors for action depend on the type of loading and shall be taken from national regulations.

### Setting information

#### Setting details

Anchor size		6		
Type		HUS <sup>1)</sup>		HUS-HR, CR <sup>2)</sup> HUS3-H, PL, P, PS, I, I-Flex, A, C
		HR	CR	
Effective anchorage depth	$h_{ef}$ [mm]	25		
Bottom flange thickness	$d_b \geq$ [mm]	25		
Nominal diameter of drill bit	$d_0$ [mm]	6		
Cutting diameter of drill bit	$d_{cut} \leq$ [mm]	6,4		
Nominal depth of drill hole <sup>4)</sup>	$h_1 \geq$ [mm]	38		
Clearance hole diameter	$d_f$ [mm]	9		
Distance between anchor and prestressing steel	$a_p \geq$ [mm]	50		
Core distance	$l_c \geq$ [mm]	100		
Pre-stressing steel distance	$l_p \geq$ [mm]	100		
Installation torque	$T_{inst}$ [mm]	- <sup>3)</sup>		18

1) Hilti Technical Data for embedment depth of 30 mm

2) ETA-10/0005 issue 2018-11-12

3) Hand setting in concrete base material not allowed (machine setting only)

4) Nominal depth of drill hole may be deeper than bottom flange thickness

Anchor size		8	
Type		HUS3-C, H, HF	HUS3-C, H, HF
Effective anchorage depth	$h_{ef}$ [mm]	30	30
Bottom flange thickness	$d_b \geq$ [mm]	30	30
Nominal diameter of drill bit	$d_0$ [mm]	8	10
Cutting diameter of drill bit	$d_{cut} \leq$ [mm]	8,45	10,45
Nominal depth of drill hole <sup>1)</sup>	$h_1 \geq$ [mm]	40	40
Clearance hole diameter	$d_f$ [mm]	12	14
Distance between anchor and prestressing steel	$a_p \geq$ [mm]	50	50
Core distance	$l_c \geq$ [mm]	100	100
Pre-stressing steel distance	$l_p \geq$ [mm]	100	100

1) Nominal depth of drill hole may be deeper than bottom flange thickness

### Screw length and thickness of fixture used in precast pre-stressed hollow core slabs for size 6

Anchor size		6								
Type		HUS		HUS3						
		HR	CR	H	C	A	PL	P	PS	I
Length of screw [mm]	Nominal embedment depth [mm]	$h_{nomd}$								
		Thickness of fixture [mm] $t_{fix}$								
35		-	-	-	-	0	-	-	0	-
40		-	-	5	5	-	-	5	5	-
45		15	-	-	-	-	-	-	-	-
55		-	-	-	-	20	-	-	-	20
60		5-25	5-25	5-25	5-25	-	5-25	5-25	5-25	-
70		15-35	15-35	-	15-35	-	-	-	-	-
80		-	-	25-45	-	-	-	25-45	-	-
100		-	-	45-65	-	-	-	-	-	-
120		-	-	65-85	-	-	-	-	-	-
135		-	-	-	-	-	-	-	-	80-100
155		-	-	-	-	-	-	-	-	100-120
175		-	-	-	-	-	-	-	-	120-140
195		-	-	-	-	-	-	-	-	140-160

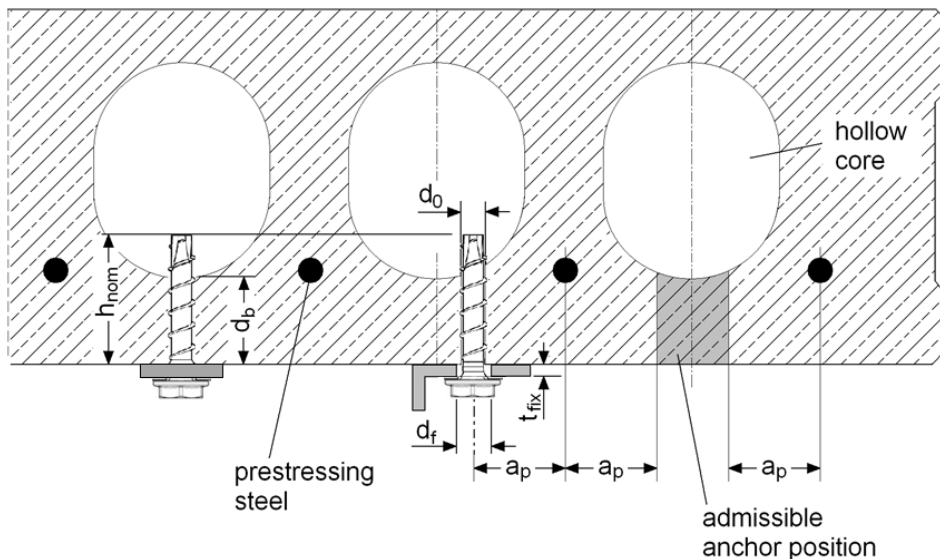

Screw length and thickness of fixture used in precast pre-stressed hollow core slabs for size 8

Anchor Type	Size [mm]	Length [mm]	d <sub>b</sub> =30 [mm]		d <sub>b</sub> =35 [mm]		d <sub>b</sub> =40 [mm]		d <sub>b</sub> =50 [mm]	
			t <sub>fix,min</sub> [mm]	t <sub>fix,max</sub> [mm]	t <sub>fix,min</sub> [mm]	t <sub>fix,max</sub> [mm]	t <sub>fix,min</sub> [mm]	t <sub>fix,max</sub> [mm]	t <sub>fix,min</sub> [mm]	t <sub>fix,max</sub> [mm]
HUS3-H	8	55	5	15	5	10	5	5	5	5
		65	5	25	5	20	5	15	5	5
		75	5	35	5	30	5	25	5	15
		85	15	45	15	40	15	35	15	25
		100	30	60	30	55	30	50	30	40
		120	50	80	50	75	50	70	50	60
		150	80	110	80	105	80	100	80	90
HUS3-HF	8	65	5	25	5	20	5	15	5	5
		75	5	35	5	30	5	25	5	15
		85	15	45	15	40	15	35	15	25
		100	30	60	30	55	30	50	30	40
HUS3-C	8	65	15	25	15	20	15	15	15	5
		75	15	35	15	30	15	25	15	15
		85	15	45	15	40	15	35	15	25
HUS3-H	10	60	5	15	5	10	5	5	5	5
		70	15	25	15	20	15	15	15	5
		80	5	35	5	30	5	25	5	15
		90	5	45	5	40	5	35	5	25
		100	15	55	15	50	15	45	15	35
		110	25	65	25	60	25	55	25	45
		130	45	85	45	80	45	75	45	65
		150	65	105	65	100	65	95	65	85
HUS3-HF	10	60	5	15	5	10	5	5	5	5
		80	5	35	5	30	5	25	5	15
		100	15	55	15	50	15	45	15	35
		110	25	65	25	60	25	55	25	45
HUS3-C	10	70	15	25	15	20	15	15	15	10
		90	15	45	15	40	15	35	15	25
		100	15	55	15	50	15	45	15	35

Chemical anchors

Screw

Mechanical anchors

Plastic/Light duty metal anchors

Insulation anchors

### Anchor spacing and edge distance

Type			HUS-HR, CR HUS3-H, PL,P, PS, I, I-Flex, A, C
Minimum edge distance	$c_{min} \geq$	[mm]	100
Minimum anchor spacing	$s_{min} \geq$	[mm]	100
Minimum distance between anchor groups	$a_{min} \geq$	[mm]	100

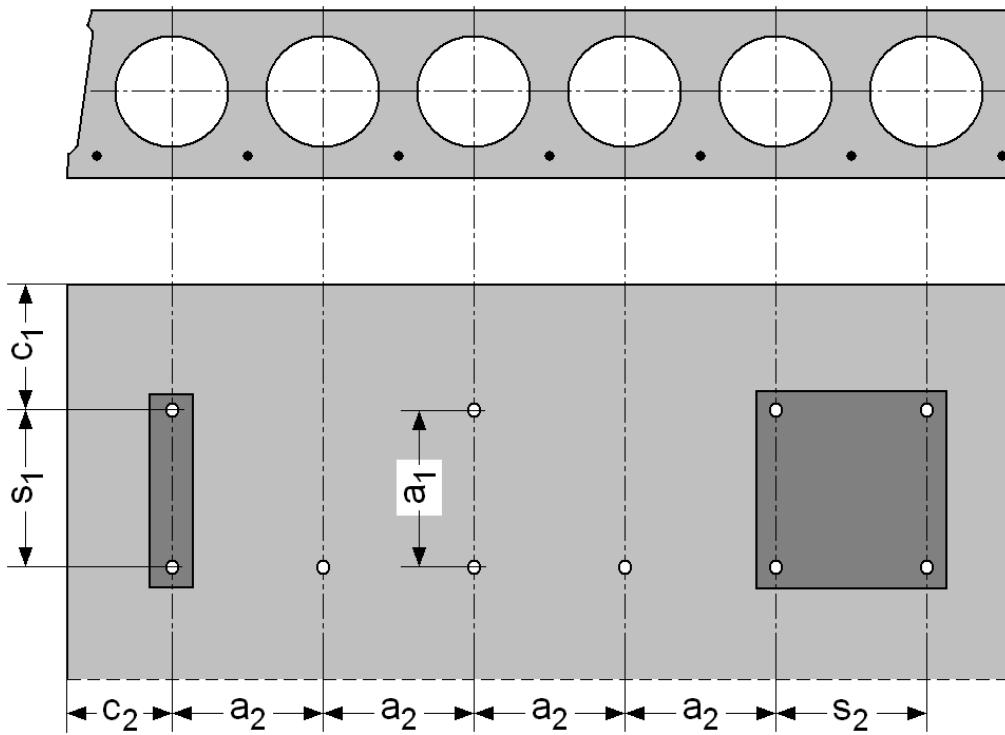

$c_1, c_2$  edge distance  
 $s_1, s_2$  Anchor spacing  
 $a_1, a_2$  Distances between anchor groups

## Setting instructions

\*For detailed information on installation see instruction for use given with the package of the product

### Installation in hollow core slabs

#### 1. Checking the anchor with tube Hilti HSB

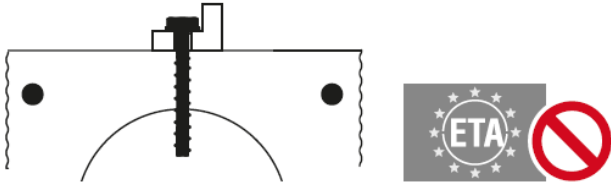

#### 2. Positioning pre-stressed steel

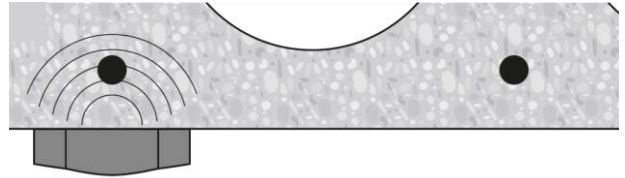

#### 3. Marking pre-stressed steel position

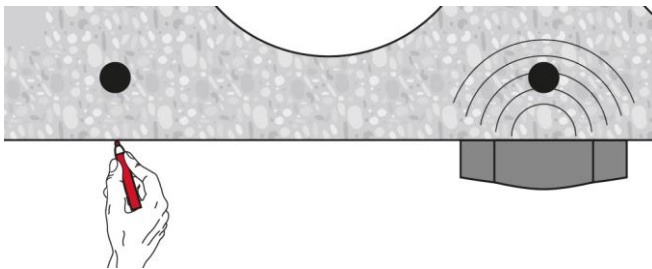

#### 4. Marking pre-stressed steel position

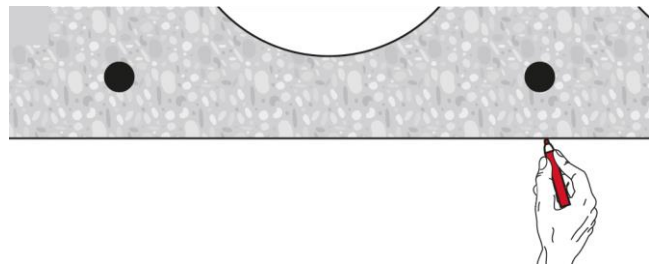

#### 5. Drilling

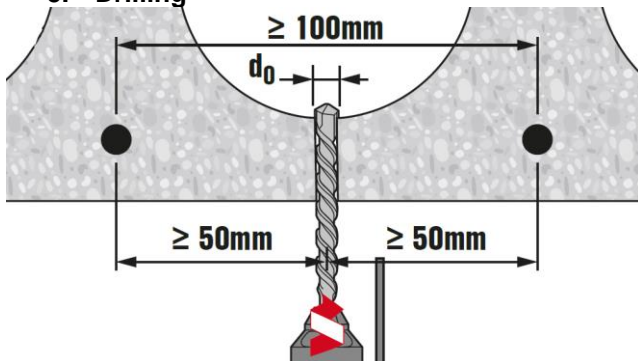

#### 6. Setting the anchor

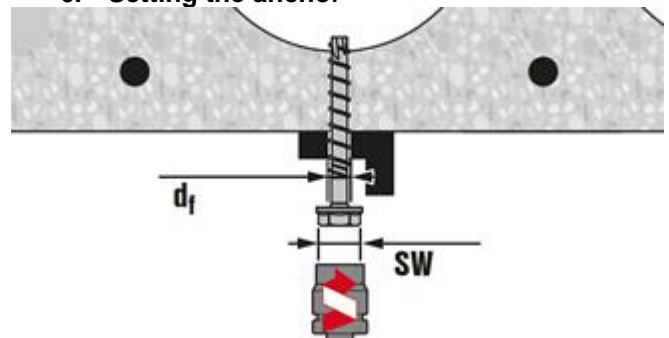

#### 7. Setting the anchor

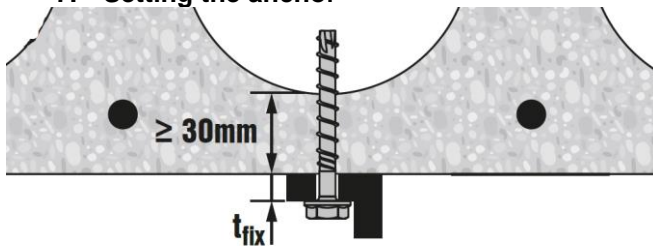

#### 8. Checking

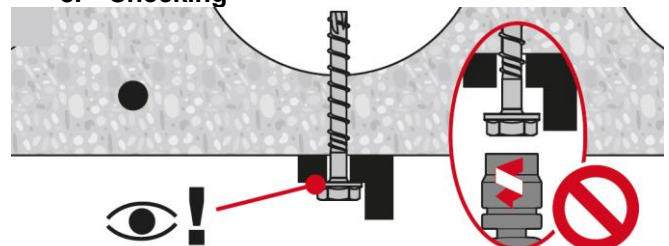





# HUS-HR / HUS-CR Screw anchor

Ultimate performance screw anchor for single point fastening



Chemical anchors



Screw



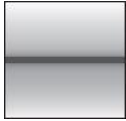

Mechanical anchors

Plastic/Light duty metal anchors

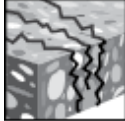
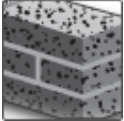
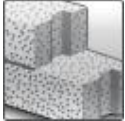
Insulation anchors

Anchor version	Benefits
 <p>HUS-H (10)</p>	<ul style="list-style-type: none"> <li>- High productivity- less drilling and fewer operations than with conventional anchors</li> <li>- ETA approval for cracked and non-cracked concrete</li> <li>- ETA approval for Seismic C1</li> <li>- Technical data for reusability in fresh concrete (<math>f_{ck,cube} = 10/15/20 \text{ Nmm}^2</math>) for temporary applications</li> </ul>
 <p>HUS-HR (6-14)</p>	
 <p>HUS-CR (6-14)</p>	

Base material	Load conditions
 <p>Concrete (non-cracked)</p>	 <p>Static / quasi-static</p>  <p>Seismic ETA-C1</p>  <p>Fire resistance</p>
 <p>Concrete (cracked)</p>	
 <p>Solid brick</p>	
 <p>Autoclaved aerated concrete</p>	

Installation conditions	Other information
 <p>Small edge distance and spacing</p>	 <p>European Technical Assessment</p>
	 <p>CE conformity</p>
	 <p>Corrosion resistance</p>
	 <p>PROFIS design software</p>

Approvals / certificates		
Description	Authority / Laboratory	No. / date of issue
European Technical Assessment	DIBt, Berlin	ETA-08/0307 / 2018-08-23
Fire test report	DIBt, Berlin	ETA-08/0307 / 2018-08-23
Fire test report ZTV – Tunnel (EBA)	MFPA, Leipzig	PB III / 08-354 / 2008-11-27

a) All data given in this section according ETA-08/0307 issue 2018-08-23.

## Static and quasi-static resistance (for a single anchor)

### All data in this section applies to:

- Correct setting (See setting instruction)
- No edge distance and spacing influence
- Steel failure
- Minimum base material thickness
- Concrete C 20/25,  $f_{ck,cube} = 25 \text{ N/mm}^2$

### Effective anchorage depth for static

Anchor size		6	8			10				14		
Type	HUS-	HR,CR	HR,CR			HR,CR			H		HR	
Nominal anchorage depth $h_{ef}$ [mm]		55	50 <sup>a)</sup>	60	80	60 <sup>a)</sup>	70	90	70	85	70	110

a) Hilti Technical Data for embedment depth

### Characteristic resistance

Anchor size		6	8			10				14	
Type	HUS-	HR,CR	HR, CR			HR, CR				HR	
<b>Non-cracked concrete</b>											
Tension $N_{Rk}$	[kN]	9,0	9,0 <sup>a)</sup>	12,0	16,0	12,0 <sup>a)</sup>	16,0	25,0	-	18,9	40,2
Shear $V_{Rk}$	[kN]	17,0	23,6 <sup>a)</sup>	26,0	26,0	31,4 <sup>a)</sup>	33,0	33,0	-	37,8	77,0
<b>Cracked concrete</b>											
Tension $N_{Rk}$	[kN]	5,0	5,0 <sup>a)</sup>	6,0	12,0	7,5 <sup>a)</sup>	9,0	16,0	-	12,0	25,0
Shear $V_{Rk}$	[kN]	16,3	16,9 <sup>a)</sup>	23,2	26,0	22,5 <sup>a)</sup>	28,6	33,0	-	27,0	57,4

a) Hilti Technical Data

### Design resistance

Anchor size		6	8			10				14	
Type	HUS-	HR,CR	HR, CR			HR, CR				HR	
<b>Non-cracked concrete</b>											
Tension $N_{Rd}$	[kN]	4,3	5,0 <sup>a)</sup>	6,7	8,9	6,7 <sup>a)</sup>	8,9	13,9	-	10,5	22,3
Shear $V_{Rd}$	[kN]	11,3	15,7 <sup>a)</sup>	17,3	17,3	21,0 <sup>a)</sup>	22,0	22,0	-	25,2	51,3
<b>Cracked concrete</b>											
Tension $N_{Rd}$	[kN]	2,4	2,8 <sup>a)</sup>	3,3	6,7	4,2 <sup>a)</sup>	5,0	8,9	-	6,7	13,9
Shear $V_{Rd}$	[kN]	10,9	11,2 <sup>a)</sup>	15,5	17,3	15,0 <sup>a)</sup>	19,0	22,0	-	18,0	38,3

a) Hilti Technical Data

### Recommended loads<sup>b)</sup>

Anchor size		6	8			10				14	
Type	HUS-	HR,CR	HR, CR			HR, CR				HR	
<b>Non-cracked concrete</b>											
Tension $N_{Rec}$	[kN]	3,1	3,6 <sup>a)</sup>	4,8	6,3	4,8	6,3	9,9	-	7,5	16,0
Shear $V_{Rec}$	[kN]	8,1	11,2 <sup>a)</sup>	12,4	12,4	15,0	15,7	15,7	-	18,0	36,7
<b>Cracked concrete</b>											
Tension $N_{Rec}$	[kN]	1,7	2,0 <sup>a)</sup>	2,4	4,8	3,0	3,6	6,3	-	4,8	9,9
Shear $V_{Rec}$	[kN]	1,8	8,0 <sup>a)</sup>	11,0	12,4	10,7	13,6	15,7	-	12,9	27,3

a) Hilti Technical Data

b) With overall partial safety factor for action  $\gamma = 1,4$ . The partial safety factors for action depend on the type of loading and shall be taken from national regulations.

## Seismic resistance

### All data in this section applies to:

- Correct setting
- Seismic design according to TR045
- The following data are based on ETA-08/0307 issue 2015-08-27
- Concrete C20/25 to C50/60

### Effective anchorage depth for seismic C1

Anchor size		8	10	14
Type	HUS-	HR, CR	HR, CR	HR
Nominal anchorage depth	$h_{nom}$ [mm]	80	90	110

### Characteristic resistance for seismic C1

Anchor size		8	10	14
Type	HUS-	HR, CR	HR, CR	HR
<b>Characteristic tension to steel failure</b>				
Characteristic resistance	$N_{Rk,s,seis}$ [kN]	34,0	52,6	102,2
Partial safety factor	$\gamma_{Ms,seis}$ [-]	1,4		
<b>Characteristic pull-out resistance in cracked concrete C20/25 to C50/60</b>				
Characteristic resistance	$N_{Rk,p,seis}$ [kN]	7,7	12,5	17,5
Partial safety factor	$\gamma_{Ms,seis}$ [-]	1,8		
<b>Concrete cone resistance and splitting resistance</b>				
Partial safety factor	$\gamma_{Ms,seis}$ [-]	1,8		

### Characteristic resistance for seismic C1<sup>1)</sup>

Anchor size		8	10	14
Type	HUS-	HR, CR	HR, CR	HR
<b>Characteristic shear resistance to steel failure</b>				
Characteristic resistance	$V_{Rk,s,seis}$ [kN]	11,1	17,9	53,9
Partial safety factor	$\gamma_{Ms,seis}$ [-]	1,5		
<b>Concrete pryout resistance and concrete edge resistance</b>				
Partial safety factor	$\gamma_{Mc,seis}$ [-]	1,5		

1) Reduction factor  $\alpha_{gap} = 1,0$  when using the Hilti Dynamic Set.

## Fire resistance

### All data in this section applies to:

- Correct setting
- No edge distance and spacing influence
- Minimum base material thickness
- The following technical data are based on: ETA-08/0307 issue 2015-08-27

### Nominal embedment depth for resistance to fire

Anchor size		6	8		10		14	
Type	HUS-	HR	HR		HR		HR	
Nominal anchorage depth	$h_{nom}$ [mm]	55	60	80	70	90	70	110

### Recommended resistance to fire

Anchor size		6	8		10		14		
Type	HUS-	HR	HR		HR		HR		
<b>Steel failure for tension and shear load (<math>F_{Rec,s,fi} = N_{Rec,s,fi} = V_{Rec,s,fi}</math>)</b>									
Recommended tensile and shear load	R30	$F_{Rec,s,fi}$ [kN]	4,9	9,3	5,0	18,5	41,7		
	R60	$F_{Rec,s,fi}$ [kN]	3,3	6,3	3,6	12,0	26,9		
	R90	$F_{Rec,s,fi}$ [kN]	1,8	3,2	2,2	5,4	12,2		
	R120	$F_{Rec,s,fi}$ [kN]	1,0	1,7	1,5	2,4	5,4		
	R30	$M^0_{Rec,s,fi}$ [kN]	4,0	8,2	6,3	19,4	65,6		
	R60	$M^0_{Rec,s,fi}$ [kN]	2,7	5,5	4,6	12,6	42,4		
	R90	$M^0_{Rec,s,fi}$ [kN]	1,4	2,8	2,8	5,7	19,2		
	R120	$M^0_{Rec,s,fi}$ [kN]	0,8	1,5	1,9	2,5	8,5		
<b>Pull-out failure</b>									
Recommended resistance	R30	$N_{Rec,p,fi}$ [kN]	1,3	1,5	3,0	2,3	4,0	3,0	6,3
	R60								
	R90								
	R120								
<b>Concrete cone failure</b>									
Edge distance	R30 to R120	$C_{cr,N}$ [mm]	$2h_{ef}$						
Spacing	R30 to R120	$S_{cr,N}$ [mm]	$4h_{ef}$						
<b>Concrete pry-out failure</b>									
	R30 to R120	$k$ [-]	1,5	2,0	2,0		2,0		

a) The recommended loads under fire exposure include a safety factor for resistance under fire exposure  $\gamma_{Ms,fire} = 1,0$  and the partial safety factor for action  $\gamma_{Ms,fire} = 1,0$ . The partial safety factors for action shall be taken from national regulations.

## Materials

### Mechanical properties

Anchor size		6	8	10	14
Type	HUS-	HR, CR	HR, CR	HR, CR	HR
Nominal tensile strength $f_{uk}$	[N/mm <sup>2</sup> ]	1050	870	950	690
Yield strength $f_{yk}$	[N/mm <sup>2</sup> ]	900	745	815	590
Stressed cross-section $A_s$	[mm <sup>2</sup> ]	22,9	39	55,4	143,1
Moment of resistance $W$	[mm <sup>3</sup> ]	15	34	58	255
Design bending resistance $M^{0}_{Rd,s}$	[Nm]	19	36	66	193

### Material quality

Part	Material
Hexagonal head concrete screw	Stainless steel (grade A4)

### Anchor dimensions

Anchor size		6	8	10	14
Type	HUS-	HR, CR	HR, CR	HR, CR	HR
Core diameter	$d_k$ [mm]	5,4	7,05	8,4	12,6
Shaft diameter	$d_s$ [mm]	7,6	10,1	12,3	16,6
Stressed section	$A_s$ [mm]	22,9	39,0	55,4	143,1

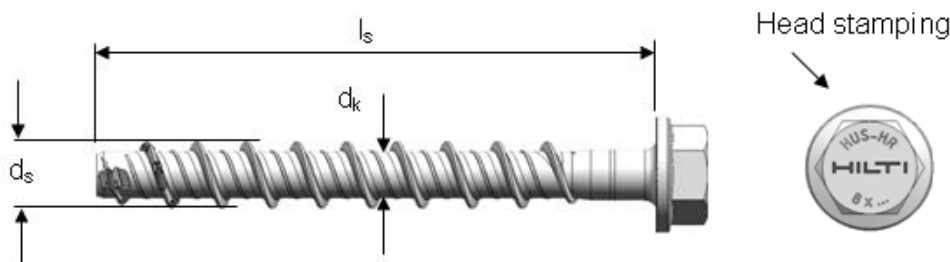

### Screw length and thickness of fixture for HUS-HR

Anchor size		6	8		10		14	
Embedment depth	$h_{nom1}, h_{nom2}$ [mm]	55	60	80	70	90	70	110
Thickness of fixture		$t_{fix}$	$t_{fix1}$	$t_{fix2}$	$t_{fix1}$	$t_{fix2}$	$t_{fix1}$	$t_{fix2}$
Length of screw [mm]	60	5	-	-	-	-	-	-
	65	-	5	-	-	-	-	-
	70	15	-	-	-	-	-	-
	75	-	15	-	5	5	10	-
	80	-	-	-	-	-	-	-
	85	-	25	5	15	-	-	-
	90	-	-	-	-	-	-	-
	95	-	35	15	25	5	-	-
	100	-	-	-	-	-	-	-
	105	-	45	25	35	15	-	-
	110	-	-	-	-	-	-	-
	115	-	-	-	45	25	-	-
	120	-	-	-	-	-	50	10
	130	-	-	-	-	-	-	-
135	-	-	-	-	-	65	25	
140	-	-	-	60	40	-	-	

### Screw length and thickness of fixture for HUS-CR

Anchor size		6	8		10			
Embedment depth		$h_{nom1}$ , $h_{nom2}$	[mm]	55	60	80	70	90
Thickness of fixture		$t_{fix1}$	$t_{fix1}$	$t_{fix2}$	$t_{fix1}$	$t_{fix2}$	$t_{fix1}$	$t_{fix2}$
Length of screw [mm]	60	5	-	-	-	-	-	-
	70	15	-	-	-	-	-	-
	75	-	15	-	-	-	-	5
	80	-	-	-	-	-	-	-
	85	-	-	-	-	15	-	-
	90	-	-	-	-	-	-	-
	95	-	35	15	-	-	-	-
	100	-	-	-	-	-	-	-
	105	-	45	25	35	15	-	

### Setting information

#### Setting details

Anchor size		6	8			10			14			
Type	HUS-	HR, CR	HR, CR <sup>a)</sup>			HR, CR <sup>a)</sup>			HR			
Nominal anchorage depth	$h_{nom}$	[mm]	55	50	60	80	60	70	90	70	110	
Effective anchorage depth	$h_{ef}$	[mm]	45	38	47	64	46	54	71	52	86	
Nominal diameter of drill bit	$d_0$	[mm]	6	8			10			14		
Cutting diameter of drill bit	$d_{cut}$	[mm]	6,4	8,45			10,45			14,5		
Clearance hole diameter	$d_f$	[mm]	9	12			14			18		
Depth of drill hole	$h_1$	[mm]	65	60	70	90	70	80	100	80	120	
Wrench size	SW	[mm]	13	13			15			21		
Diameter of countersunk	$d_h$	[mm]	-	-			21			-		
Installation torque	Concrete	$T_{inst}$	[Nm]	- <sup>a)</sup>	35	- <sup>a)</sup>	- <sup>a)</sup>	45 <sup>c)</sup>			65	
	Solid m, Mz 12	$T_{inst}$	[Nm]	10	-	16	16	- <sup>b)</sup>	20	20	- <sup>b)</sup>	- <sup>b)</sup>
	Solid m, KS 12	$T_{inst}$	[Nm]	10	-	16	16	- <sup>b)</sup>	20	20	- <sup>b)</sup>	- <sup>b)</sup>
	Aerated	$T_{inst}$	[Nm]	4	-	8	8	- <sup>b)</sup>	10	10	- <sup>b)</sup>	- <sup>b)</sup>

a) Hand setting in concrete base material not allowed ( machine setting only)

b) Hilti does not recommend this setting process for this application.

c) Installation torque refer to HUS-HR only

#### HUS-HR (hexagonal head)

6, 8, 10 and 14

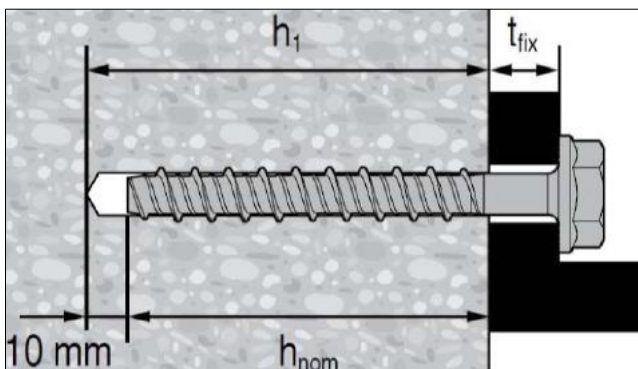

#### HUS-CR (countersunk)

6, 8 and 10

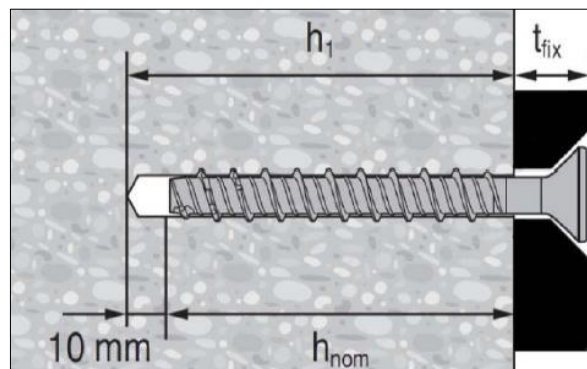



### Installation equipment

Anchor size		6	8	10	14
Type	HUS-	HR, CR	HR, CR	HR, CR	HR
Rotary hammer	TE 2 – TE 30				
Drill bit		TE-C3X 6/17	TE-C3X 8/17	TE-C3X 10/22	TE-C3X 14/22
Socket wrench insert		S-NSD 13 ½	S-NSD 13 ½	S-NSD 15 ½	S-NSD 21 ½
Torx (CR type only)		-	S-SY TX 45	S-SY TX 50	-
Impact screw driver		Hilti SIW 14-A, 22-A	Hilti SIW 22 T-A		SIW 22 T-A, SIW 9

### Setting parameters

Anchor size		6	8		10			14		
Type	HUS-	HR, CR	HR, CR <sup>a)</sup>		HR, CR <sup>a)</sup>			HR		
Nominal anchorage depth	$h_{nom}$ [mm]	55	50	60	80	60	70	90	70	110
Minimum base material	$h_{min}$ [mm]	100	100	100	120	120	120	140	140	160
Minimum spacing	$s_{min}$ [mm]	35	45	45	50	50	50	50	50	60
Minimum edge distance	$c_{min}$ [mm]	35	45	45	50	50	50	50	50	60
Critical spacing for splitting	$s_{cr,sp}$ [mm]	135	114	114	192	166	194	256	187	310
Critical edge distance for	$c_{cr,sp}$ [mm]	68	57	71	96	83	97	128	94	155
Critical spacing for concrete	$s_{cr,N}$ [mm]	135	114	114	192	166	194	256	187	310
Critical edge distance for	$c_{cr,N}$ [mm]	68	57	71	96	83	97	128	94	155

For spacing (edge distance) smaller than critical spacing (critical edge distance) the design loads have to be reduced (see system design resistance).

Critical spacing and critical edge distance for splitting failure apply only for non-cracked concrete. For cracked concrete only the critical spacing and critical edge distance for concrete cone failure are decisive.

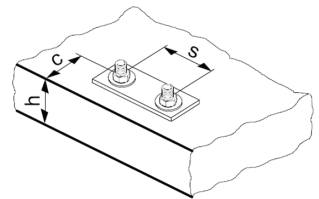

### Setting instructions

\*For detailed information on installation see instruction for use given with the package of the product

Setting instruction	
<p><b>1. Make a cylinder hole</b></p>	<p><b>2. Clean the borehole</b></p>
<p><b>3. Install the screw anchor by impact screw driver</b></p>	<p><b>4. Ensure that the fixture is caught</b></p>

## Basic loading data (for a single anchor) in solid masonry units



### All data in this section applies to:

- Load values valid for holes drilled with TE rotary hammers in hammering mod
- Correct anchor setting (see instruction for use, setting details)
- The core/material ratio may not exceed 15 % of a bed joint area
- The brim area around holes must be at least 70mm
- Edge distances, spacing and other influences, see below
- All data given in this section according to Hilti Technical Data

### Nominal embedment depth

Anchor size		6	8	10
Type	HUS-	HR	HR	HR, CR
Nominal embedment depth	$h_{nom}$ [mm]	55	60	70

### Recommended loads for HUS-HR / HUS-CR

Anchor size			6	8	10
	Solid clay brick Mz 12/2,0 DIN 105 / EN 771-1 $f_b^{a)} \geq 12 \text{ N/mm}^2$	Tension $N_{Rec}$ [kN]	0,9	1,0	1,1
		Shear $N_{Rec}$ [kN]	1,4	2,0	2,3
	Solid sand-lime brick Mz 12/2,0 DIN 106/EN 771-2 $f_b^{a)} \geq 12 \text{ N/mm}^2$	Tension $N_{Rec}$ [kN]	0,6	0,6	1,0
		Shear $N_{Rec}$ [kN]	0,9	1,1	1,7
	Aerated concrete PPW 6-0,4 DIN 4165/EN 771-4 $f_b^{a)} \geq 6 \text{ N/mm}^2$	Tension $N_{Rec}$ [kN]	0,2	0,2	0,4
		Shear $N_{Rec}$ [kN]	0,4	0,4	0,9

## Permissible anchor location in brick and block walls

### Edge distance and spacing influence

- The technical data for HUS-HR anchors are reference loads for MZ 12 and KS 12. Due to the large variation of natural stone solid bricks, on site anchor testing is recommended to validate technical data
- The HUS-HR anchor was installed and tested in center of solid bricks as shown. The HUS-HR anchor was not tested in the mortar joint between solid bricks or in hollow bricks, however a load reduction is expected
- For brick walls where anchor position in brick can not be determined, 100 % anchor testing is recommended
- Distance to free edge free edge to solid masonry (Mz and KS) units  $\geq 170\text{mm}$
- Distance to free edge free edge to solid masonry (autoclaved aerated gas concrete) units  $\geq 170\text{mm}$
- The minimum distance to horizontal and vertical mortar joint ( $c_{min}$ ) is started in drawing below
- Minimum anchor spacing ( $s_{min}$ ) in one brick/block is  $\geq 2 \cdot c_{min}$

### Limits

- Applied load to individual bricks may not exceed 1,0 kN without compression or 1,4 kN with compression
- All data is for multiple use for non-structural applications
- Plaster, graveling, lining or levelling courses are regarded as non-bearing and may not be taken into account for the calculation of embedment depth

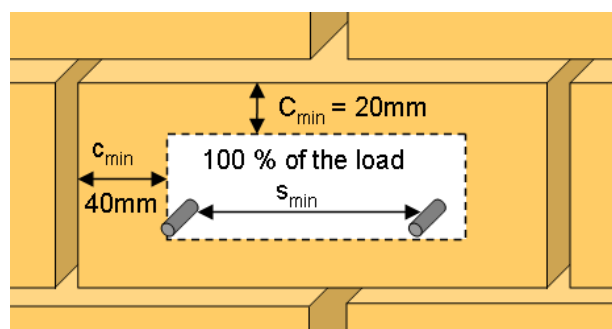

# HUS2-H Screw anchors

Premium screw anchor for use in concrete with hex head

### Anchor version

### Benefits



HUS2-H  
(8-10)

- High productivity- less drilling and fewer operations than with conventional anchors
- Suitable for cracked and non-cracked concrete C20/25
- ETA approval for cracked and non-cracked concrete
- Technical data for reusability in fresh concrete ( $f_{ck,cube} = 10/15/20 \text{ Nmm}^2$ ) for temporary applications
- Two embedment depths for maximum design flexibility

### Base material

### Load condition

### Other information



Concrete (non-cracked)



Concrete (cracked)



Tensile zone

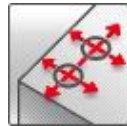

Small edge distance and spacing

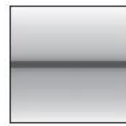

Static / quasi-static



Fire resistance



European Technical Assessment



CE conformity

### Approvals / certificates

Description	Authority / Laboratory	No. / date of issue
European Technical Assessment	ZAG, Ljubjana	ETA-19/0170 / 2019-08-30
Fire test report	ZAG, Ljubjana	ETA-19/0170 / 2019-08-30

a) All data given in this section for  $h_{nom}$  equal to 65 and 75 of size 8 and 10, respectively, is according ETA-19/0170 issue 2019-08-30.

### Static and quasi-static loading data (for a single anchor)

#### All data in this section applies to:

- Correct setting (See setting instruction)
- No edge distance and spacing influence
- Steel failure
- Minimum base material thickness
- Concrete C 20/25,  $f_{ck,cube} = 25 \text{ N/mm}^2$

### Characteristic resistance

		Hilti Technical Data		ETA 19/0170	
Anchor size		8	10	8	10
Nominal embedment depth	$h_{nom}$ [mm]	50	55	65	75
<b>Non-cracked concrete</b>					
Tension $N_{Rk}$	HUS2-H [kN]	9,0	9,0	16,0	20,0
Shear $V_{Rk}$	HUS2-H [kN]	12,0	13,6	18,4	22,7
<b>Cracked concrete</b>					
Tension $N_{Rk}$	HUS2-H [kN]	4,0	6,0	9,0	14,0
Shear $V_{Rk}$	HUS2-H [kN]	8,4	9,5	18,4	22,7

## Design resistance

		Hilti Technical Data		ETA 19/0170	
Anchor size		8	10	8	10
Nominal embedment depth	$h_{nom}$ [mm]	50	55	65	75
<b>Non-cracked concrete</b>					
Tension $N_{Rd}$	HUS2-H [kN]	5,0	5,0	8,9	11,1
Shear $V_{Rd}$	HUS2-H [kN]	8,0	9,1	12,3	15,1
<b>Cracked concrete</b>					
Tension $N_{Rd}$	HUS2-H [kN]	2,2	3,3	5,0	7,8
Shear $V_{Rd}$	HUS2-H [kN]	5,6	6,4	12,3	15,1

## Recommended loads<sup>a)</sup>

		Hilti Technical Data		ETA 19/0170	
Anchor size		8	10	8	10
Nominal embedment depth	$h_{nom}$ [mm]	50	55	65	75
<b>Non-cracked concrete</b>					
Tension $N_{Rec}$	HUS2-H [kN]	3,6	3,6	6,4	7,9
Shear $V_{Rec}$	HUS2-H [kN]	5,7	6,5	8,8	10,8
<b>Cracked concrete</b>					
Tension $N_{Rec}$	HUS2-H [kN]	1,6	2,4	3,6	5,6
Shear $V_{Rec}$	HUS2-H [kN]	4,0	4,6	8,8	10,8

a) With overall partial safety factor for action  $\gamma = 1,4$ . The partial safety factors for action depend on the type of loading and shall be taken from national regulations.

## Fire resistance

### All data in this section applies to:

- Correct setting (see setting instruction)
- No edge distance and spacing influence
- Minimum base material thickness
- For more fire resistance data please see the full ETA-19/0170 report.

### Designed loads under fire exposure<sup>1)</sup>

Anchor size		8		10	
Nominal embedment depth	$h_{nom}$ [mm]	65		75	
<b>Steel failure for tension and shear load (<math>F_{Rec,s,fi} = N_{Rec,s,fi} = V_{Rec,s,fi}</math>)</b>					
Designed tensile and shear load	R30	$F_{Rd,s,fi}$ [kN]	0,4	0,9	
	R120	$F_{Rd,s,fi}$ [kN]	0,2	0,5	
	R30	$M^0_{Rd,s,fi}$ [Nm]	0,4	1,1	
	R120	$M^0_{Rd,s,fi}$ [Nm]	0,2	0,6	
<b>Pull-out failure</b>					
Designed resistance	R30 to R90	$N_{Rd,p,fi}$ [kN]	2,2	3,5	
	R120	$N_{Rd,p,fi}$ [kN]	1,8	2,8	
<b>Concrete cone failure</b>					
Designed resistance	R30 to R90	$N^0_{Rd,p,fi}$ [kN]	3,3	4,7	
	R120	$N^0_{Rd,p,fi}$ [kN]	2,7	3,8	
Edge distance <sup>2)</sup>	R30 to R120	$c_{cr,fi}$ [m]	2 $h_{ef}$		
Spacing	R30 to R120	$s_{cr,fi}$ [m]	2 $c_{cr,fi}$		
<b>Concrete pry-out failure</b>					
	R30 to R120	k [-]	1,0	1,0	
The anchorage depth has to be increased for wet concrete by at least 30 mm compared to the given value.					

1) The designed loads under fire exposure include a safety factor for resistance under fire exposure  $\gamma_{Ms,fire} = 1,0$  and the partial safety factor for action  $\gamma_{Ms,fire} = 1,0$ .

2) In case of fire attack from more than one side, the minimum edge distance shall be  $\geq 300$  mm.

## Materials

### Mechanical properties

Anchor size		8	10
Nominal tensile strength $f_{uk}$	[N/mm <sup>2</sup> ]	880	715
Yield strength $f_{yk}$	[N/mm <sup>2</sup> ]	755	610
Stressed cross-section $A_s$	[mm <sup>2</sup> ]	39,6	59,4
Moment of resistance $W$	[mm <sup>3</sup> ]	35	65
Characteristic bending resistance $M^{0}_{RK,s}$	[Nm]	37	55

### Material quality

Part	Material
HUS2-H	Carbon steel; Galvanized $\geq 5 \mu\text{m}$

### Anchor dimensions

Anchor size		8	10
Threaded outer diameter	$d_t$ [mm]	10,6	12,65
Core diameter	$d_k$ [mm]	7,1	8,7
Shaft diameter	$d_s$ [mm]	8,45	10,55
Stressed section	$A_s$ [mm <sup>2</sup> ]	39,6	59,4

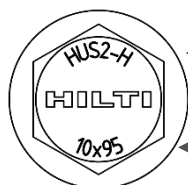
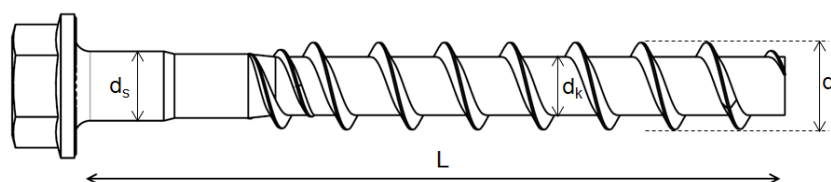

**HUS2-H** : Premium Hilti Screw anchor – hexagonal head

**10x95** : screw diameter x screw length

### Screw length and thickness of fixture for HUS2-H (hex head)

Anchor size		8		10	
Nominal anchorage depth	$h_{nom1}, h_{nom2}$ [mm]	50	65	55	75
Thickness of fixture		$t_{fix1}$	$t_{fix2}$	$t_{fix1}$	$t_{fix2}$
Length of anchor [mm]	55	5	-	-	-
	60	-	-	5	-
	75	25	10	-	-
	85	35	20	30	10
	95	45	30	40	20
	105	-	-	50	30
	130	-	-	75	55

## Setting information

### Setting details

Anchor size			8		10	
Thread engagement length	$h_{nom}$	[mm]	50	65	55	75
Nominal diameter of drill bit	$d_0$		8		10	
Cutting diameter of drill bit	$d_{cut} \leq$	[mm]	8,45		10,45	
Drill hole depth	$h_1 \geq$	[mm]	60	75	65	85
Maximum diameter of clearance hole in the fixture <sup>2)</sup>	$d_f \leq$	[mm]	12		14	
Width across	SW	[mm]	13		15	

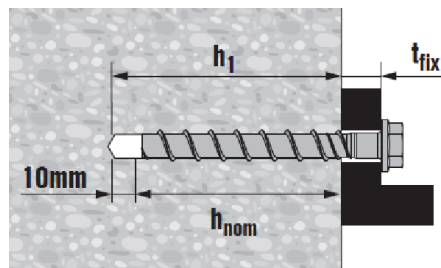

### Installation equipment

Anchor size	8	10
Rotary hammer	TE 2 – TE 30	
Drill bit for concrete	CX 8	CX 10
Socket wrench insert	S-NSD 13 1/2	S-NSD 15 1/2
Tube for temporary application	HRG D=8-10-14 MM	
Setting tool for concrete C12/15 to C50/60	SIW 22T-A 1/2"; SIW 6AT-A22	

### Setting parameters

Anchor size			8		10	
Nominal anchorage depth	$h_{nom}$	[mm]	50	65	55	75
Effective anchorage depth	$h_{ef}$	[mm]	39,1	51,9	42,5	59,5
Minimum base material thickness	$h_{min}$	[mm]	100	110	100	130
Minimum spacing	$s_{min}$	[mm]	40	50	50	50
Minimum edge distance	$c_{min}$	[mm]	50	50	50	50
Critical spacing for splitting failure	$s_{cr,sp}$	[mm]	117	140	130	180
Critical edge distance for splitting failure	$c_{cr,sp}$	[mm]	59	70	65	90
Critical spacing for concrete cone failure	$s_{cr,N}$	[mm]	117,3	155,7	127,5	178,5
Critical edge distance for concrete cone failure	$c_{cr,N}$	[mm]	58,65	77,85	63,75	89,25

For spacing (edge distance) smaller than critical spacing (critical edge distance) the design loads have to be reduced.

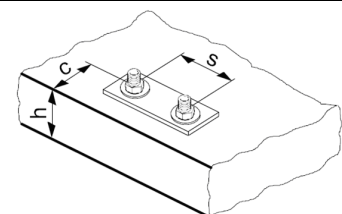

## Setting instructions

### Setting instruction

#### 1. Make a cylinder hole

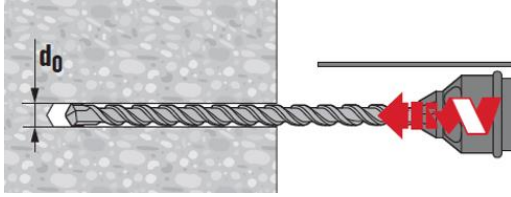

#### 2. Clean the borehole

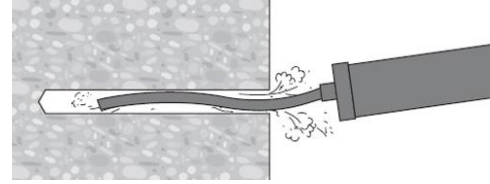

#### 3. Install the screw anchor by impact screw driver

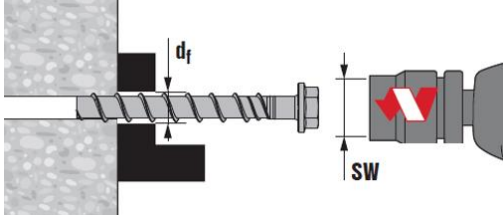

#### 4. Ensure that the fixture is caught

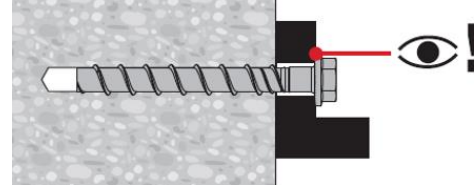

\*For detailed information on installation see instruction for use given with the package of the product

**Basic loading data for temporary application in standard & fresh concrete < 28 days old,  $f_{ck,cube} \geq 10 \text{ N/mm}^2$ :**

**All data in this section applies to the following conditions:**

- Strength class,  $f_{ck,cube} \geq 10 \text{ N/mm}^2$
- Only temporary use
- Screw is reusable, before each usage it must be checked according Hilti instruction for use with the suited tube Hilti HRG D=8,10,14 MM
- Design resistance and recommended load are valid for single anchor only
- Design resistance as well as the recommended load are valid for all load direction and valid for both cracked and non-cracked concrete
- Minimum base material thickness
- No edge distance and spacing influence

### Design resistance

Anchor size	HUS2-H	8		10	
Nominal embedment depth	$h_{nom} \text{ [mm]}$	50	65	55	75
Cracked and non-cracked concrete					
Tensile $N_{Rd}$ = Shear $V_{Rd}$					
$f_{ck,cube} \geq 10 \text{ N/mm}^2$	[kN]	1,4	3,0	1,7	3,2
$f_{ck,cube} \geq 15 \text{ N/mm}^2$	[kN]	1,7	3,7	2,1	3,9
$f_{ck,cube} \geq 20 \text{ N/mm}^2$	[kN]	2,0	4,2	2,4	4,5



### Recommended load

Anchor size		HUS2-H	8		10	
Nominal embedment depth	$h_{nom}$	[mm]	50	65	55	75
Tensile $N_{rec}$ = Shear $V_{rec}$						
	$f_{ck,cube} \geq 10 \text{ N/mm}^2$	[kN]	1,0	2,1	1,2	2,3
	$f_{ck,cube} \geq 15 \text{ N/mm}^2$	[kN]	1,2	2,6	1,5	2,8
	$f_{ck,cube} \geq 20 \text{ N/mm}^2$	[kN]	1,4	3,0	1,7	3,2

a) With overall partial safety factor for action  $\psi = 1,4$ . The partial safety factors for action depend on the type of loading and shall be taken from national regulations.

### Setting details

Anchor size		HUS2-H	8		10	
Nominal anchorage depth	$h_{nom}$	[mm]	50	65	55	75
Minimum base material thickness	$h_{min}$	[mm]	100	110	100	130
Minimum spacing	$s_{min}$	[mm]	135	225	150	240
Minimum edge distance direction 1	$c_1$	[mm]	45	75	50	80
Minimum edge distance direction 2	$c_2$	[mm]	70	115	75	120

### Setting details

Anchor size		HUS2-H	8		10	
Nominal anchorage depth	$h_{nom}$	[mm]	50	65	55	75
Nominal diameter of drill bit	$d_o$	[mm]	8		10	
Cutting diameter of drill bit	$d_{cut} \leq$	[mm]	8,45		10,45	
Depth of drill bit	$h_1 \leq$	[mm]	60	75	65	85
Diameter of clearance hole the fixture	$d_f \leq$	[mm]	12		14	
Width across	SW	[mm]	13		15	
Impact screw driver	SIW 22T-A 1/2"; SIW 6AT-A22					
Suited tube	HRG D=8-14 MM					

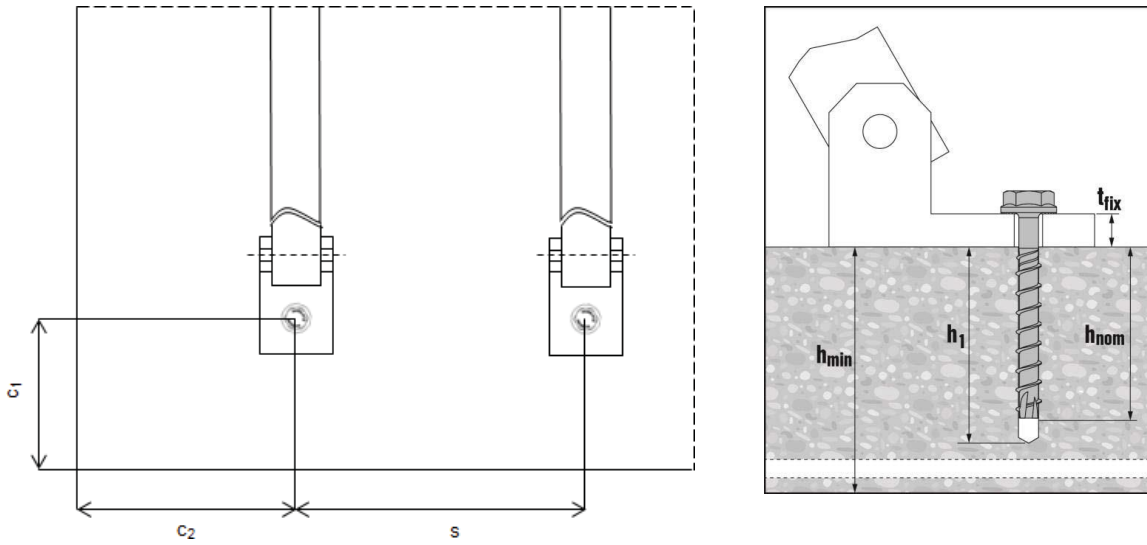

### Tube specification

Anchor size / tube		8 / HRG 8	10 / HRG 10
Inner tube diameter	$\varnothing_i$ [mm]	9,7	11,7
Outer tube diameter	$\varnothing_e$ [mm]	15,0	17,0
Tube length	Lt [mm]	23,0	28,0

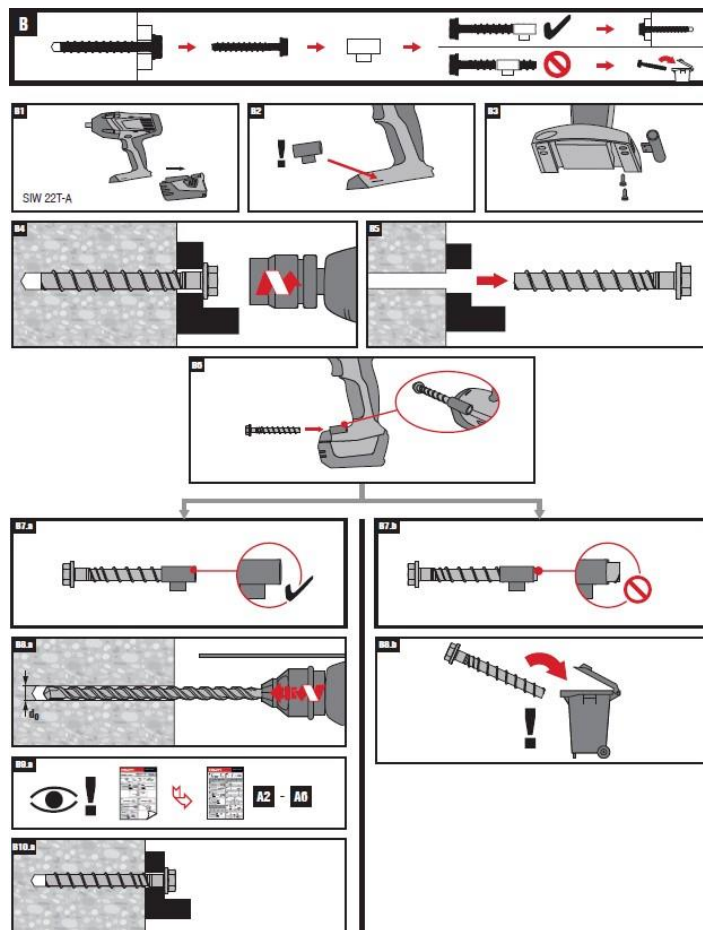

### Instruction for use – re-use of screw







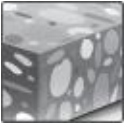

# HUS 6 / HUS-S 6 Screw anchor

Everyday standard screw anchor

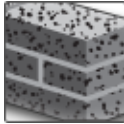
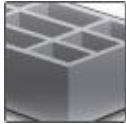
Anchor version		Benefits
	HUS 6 (6)	- Quick and easy setting - Low expansion forces in base materials
	HUS-S 6 (6)	- Through fastening - Removable

Base material	Load conditions
 Concrete (non-cracked)  Concrete (cracked)  Solid brick  Hollow brick  Autoclaved aerated concrete	 Fire resistance

Installation conditions
 Small edge distance and spacing  Redundant fastening

Approvals / certificates		
Description	Authority / Laboratory	No. / date of issue
Assessment report (fire)	warringtonfire	WF327804/A 2013-07-10

### Basic loading data (for a single anchor)

**All data in this section applies to:**

- Correct setting (See setting instruction)
- No edge distance and spacing influence
- Concrete as specified in the table
- **Steel** failure
- Minimum base material thickness
- Concrete C 20/25,  $f_{ck,cube} = 25 \text{ N/mm}^2$
- Applied loads to individual bricks/blocks without compression may not exceed 1,0 kN
- Applied loads to individual bricks/blocks with compression may not exceed 1,4 kN
- Data applies only to bricks/blocks, there is no test data available for loads in mortar joints. Hilti recommends at least 50% load reduction or on site testing, if the location of the anchor in relation to the joint can not be specified because of wall plaster or insulation.
- Plaster, gravelling, lining or levelling courses are regarded as non-bearing and may not be taken into account for calculation of embedment depth

**Note:**

When tightening the screw anchor in soft base materials and in hollow brick, care must be taken not to apply too much torque. If the screw anchor is over-tightened the fastening point is unusable for the HUS 6.

Base material		Solid masonry units		Autoclaved aerated concrete	
		Mz 12 Solid brick	KS 12 Solid lime block	PB6 Block	PB2 Block
Compressive strength	[N/mm <sup>2</sup> ]	12	12	6	2
Bulk density	[N/mm <sup>2</sup> ]	1,8	2,0	0,6	0,2
Format (length/width/height)	[mm]	240/175/113	240/175/113	-	-

**Recommended loads<sup>e)</sup>**

Anchor size		6													
Anchor type		HUS 6													
Base material		Non-cracked concrete		Cracked concrete <sup>a)</sup>	Solid brick <sup>b)</sup> MZ 20		Lime block <sup>b)</sup> KS sand		Hollow Brick <sup>b)</sup> Hz 0.8/12		PB / PB4 <sup>c)d)</sup>		PB6 <sup>c)</sup>		
		h <sub>nom</sub> [mm]	60	30	44	60	30	60	30	60	30	60	30	60	30
Nominal embed. depth	h <sub>nom</sub> [mm]	34		44	44		44		64		64		64		
Edge distance	c ≥ [mm]	60	30	100	60	30	60	30	60	30	60	30	60	30	
Tension	N <sub>Rec</sub> [kN]	1,0	1,0	0,5	0,2	0,2	1,0	1,0	0,1	0,1	0,2	0,2	0,2	0,2	
Shear	V <sub>Rec</sub> [kN]	1,6	0,5	0,5	0,4	0,3	1,1	0,4	0,4	0,2	0,3	0,1	0,6	0,2	

- a) Redundant fastening
- b) Holes must be drilled using rotary action only (no hammering action)
- c) Aerated concrete
- d) No anchor hole drilling required in PB2/PB4 gas aerated concrete
- e) With overall partial safety factor for action  $\gamma = 1,4$ . The partial safety factors for action depend on the type of loading and shall be taken from national regulations.

## Materials

### Mechanical properties

Anchor size	HUS 6 / HUS-S 6	
Nominal tensile strength $f_{uk}$ [N/mm <sup>2</sup> ]	1000	
Yield strength $f_{yk}$ [N/mm <sup>2</sup> ]	900	
Stressed cross-section $A_s$ [mm <sup>2</sup> ]	5,2	
Moment of resistance $W$ [mm <sup>3</sup> ]	13,8	
Design bending resistance $M^0_{Rk,s}$ [Nm]	11	

### Material quality

Part	Material
Screw anchor	Carbon Steel,galvanized $\geq 5 \mu\text{m}$

### Anchor dimensions

Anchor size	HUS 6		HUS-S 6	
Nominal length of screw $l_s$ [mm]	35 - 220		100 - 220	
Core diameter $d_k$ [mm]	5,3		5,3	
Shaft diameter $d$ [mm]	7,5		7,5	

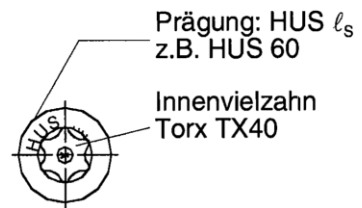
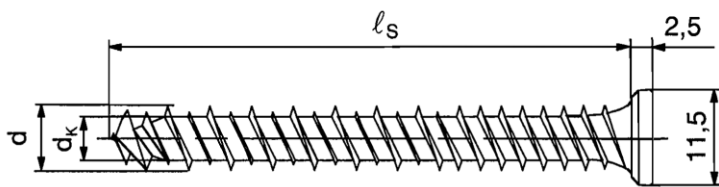

### Head configuration HUS-S

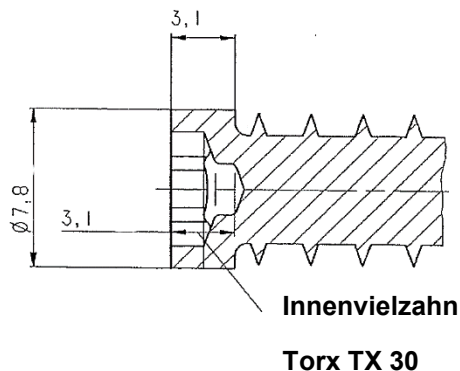

## Setting information

### Setting details

Anchor size	6				
Anchor type	HUS				
Base material	Concrete C20/25	Solid brick /Mz 20	Hollow Brick Hlz 0.8/12	PB / PB4 <sup>c)</sup>	PB6 <sup>c)</sup>
Nominal embed. depth $h_{nom}$ [mm]	34	44	64	64	64
Nominal diameter of drill bit $d_0$ [mm]	6	6	6	-	6
Cutting diameter of drill bit $d_{cut}$ [mm]	6,4	6,4	6,4	-	6,4
Minimum depth of drill hole $h_1 \geq$ [mm]	50	54 <sup>b)</sup>	64 <sup>a)</sup>	- <sup>b)</sup>	70
Diameter of clearance hole in the fixture to clamp a fixture $d_f \leq$ [mm]	8,5				
Diameter of clearance hole in the fixture for stand-off $d_f \leq$ [mm]	6,2				
Max. fastening thickness $t_{fix}$ [mm]	$l_s - h_{nom}$				
Max. installation torque $T_{inst}$ [mm]	10	4	2	2	2

- a) Holes must be drilled using rotary action only (no hammering action)  
 b) No anchor hole drilling required in PB2/PB4 gas aerated concrete  
 c) Aerated concrete

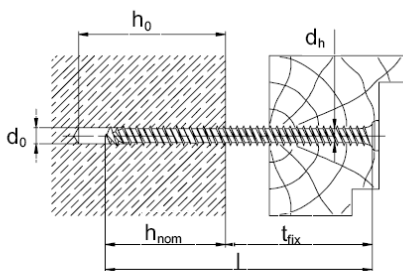

HUS

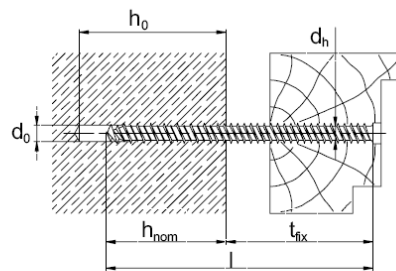

HUS-S

### Installation equipment

Anchor size	HUS 6	HUS-S 6
Rotary hammer	TE 6 / TE 7	
Drill bit	TE-C3X 6/17	
Recommended setting tool	SID / SIW 121, SID / SIW 144, TKI 2500	
Accessories	S-B TXI 40 bit	S-B TXI 30 bit



**Permissible anchor location in brick and block walls:**

- Distance to free edge free edge to solid masonry (HLz and autoclaved aerated gas concrete) units  $\geq 170$  mm
- Distance to free edge free edge to solid masonry (Mz and KS) units  $\geq 200$  mm
- The minimum distance to horizontal and vertical mortar joint ( $c_{min}$ ) is stated in the recommended load table.
- Data applies only to bricks/blocks, there is no test data available for loads in mortar joints. Hilti recommends at least a 50% load reduction or on site testing, if the location of the anchor in relation to the joint (see drawing) can not be specified because of wall plaster or insulation.
- Minimum anchor spacing ( $s_{min}$ ) in one brick/block is  $\geq 2 \cdot c_{min}$

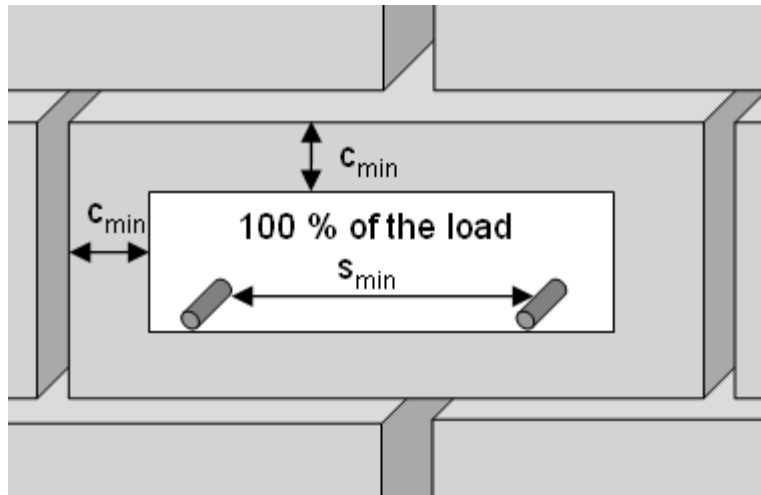

**Setting instructions**



\*For detailed information on installation see instruction for use given with the package of the product

Setting instruction for HUS		
<p>1. Drill hole with drill bit</p>	<p>2. Clean the hole</p>	<p>3. Install the anchor with an electric screw driver</p>
Setting instruction for HUS-S		
<p>1. Drill hole with drill bit</p>	<p>2. Clean the hole</p>	<p>3. Install the anchor with an electric screwdriver.</p>





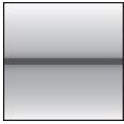

# HKD Flush anchor

Everyday standard manual set flush anchor for single anchor applications

Anchor version	Benefits
 <p>HKD (M8-M20)</p>	<ul style="list-style-type: none"> <li>- Simple and well proven</li> <li>- Approved, tested and confirmed by everyday jobsite experience</li> <li>- Reliable setting thanks to simple visual check</li> <li>- Versatile</li> <li>- For medium-duty fastening with bolts or threaded rods</li> <li>- Available in various materials and sizes for maximized coverage of possible applications</li> </ul>
 <p>HKD-S(R) (M6-M20)</p>	
 <p>HKD-E(R) (M6-M20)</p>	

Base material	Load conditions
 <p>Concrete (non-cracked)</p>	 <p>Static/ quasi-static</p>

Installation conditions	Other information
 <p>Hammer drilled holes</p>	 <p>European Technical Assessment</p>  <p>CE conformity</p>  <p>PROFIS Anchor design Software</p>  <p>A4 316 Corrosion resistance</p>

## Approvals / certificates

Description	Authority / Laboratory	No. / date of issue
European Technical Assessment <sup>a)</sup>	CSTB, Marne-la-Vallée	ETA-02/0032 / 2015-01-07

a) All data given in this section according to ETA-02/0032, issue 2015-01-07.

## Static resistance

### All data in this section applies to:

- Correct setting (See setting instruction)
- No edge distance and spacing influence
- Concrete as specified in the table
- Steel failure
- Minimum base material thickness
- Concrete C 20/25,  $f_{ck,cube} = 25 \text{ N/mm}^2$
- Screw or rod with steel grade 5.8 (carbon steel) and / or A4-70 (stainless steel)

### Effective anchorage depth for static

Anchor size	M6	M8	M10	M12	M16	M8	M8	M10	M10	M12	M16	M20
Eff. anchorage depth range $h_{ef}$ [mm]	25	25	25	25	30	30	40	30	40	50	65	80

### Characteristic resistance

Anchor size		Hilti technical data				ETA-02/0032, issued 2015-01-07							
		M6x25	M8x25	M10x25	M12x25	M6x30	M8x30	M8x40	M10x30	M10x40	M12x50	M16x65	M20x80
Tension $N_{Rk}$	HKD	6,3	6,3	6,3	6,3	-	8,3	9,0	8,3	12,8	17,8	26,4	36,1
	HKD-S, HKD-E	6,3	-	-	-	8,3	8,3	9,0	8,3	12,8	17,8	26,4	36,1
	HKD-SR, HKD-ER	6,3	-	-	-	8,3	8,3	-	-	12,8	17,8	26,4	36,1
Shear $V_{Rk}$	HKD	5,0	6,3	6,3	6,3	-	8,6	9,2	10,0	11,0	18,3	33,8	49,0
	HKD-S, HKD-E	5,0	-	-	-	5,0	7,0	7,0	7,4	8,0	14,1	21,9	34,7
	HKD-SR, HKD-ER	6,2	-	-	-	6,4	8,4	-	-	10,5	18,7	32,1	51,0

### Design resistance

Anchor size		Hilti technical data				ETA-02/0032, issued 2015-01-07							
		M6x25	M8x25	M10x25	M12x25	M6x30	M8x30	M8x40	M10x30	M10x40	M12x50	M16x65	M20x80
Tension $N_{Rd}$	HKD	4,2	4,2	4,2	4,2	-	5,5	6,0	5,5	8,5	11,9	17,6	24,0
	HKD-S, HKD-E	3,0	-	-	-	4,6	4,6	5,0	4,6	7,1	9,9	17,6	24,0
	HKD-SR, HKD-ER	3,0	-	-	-	4,6	4,6	-	-	7,1	9,9	17,6	24,0
Shear $V_{Rd}$	HKD	4,0	4,2	4,2	4,2	-	6,9	7,3	8,0	8,8	14,6	27,0	39,4
	HKD-S, HKD-E	3,9	-	-	-	3,9	5,5	5,5	5,9	6,4	11,3	17,5	27,8
	HKD-SR, HKD-ER	4,1	-	-	-	4,2	5,5	-	-	6,9	12,3	21,1	33,6

### Recommended loads <sup>a)</sup>

Anchor size		Hilti technical data				ETA-02/0032, issued 2015-01-07							
		M6x25	M8x25	M10x25	M12x25	M6x30	M8x30	M8x40	M10x30	M10x40	M12x50	M16x65	M20x80
Tension $N_{Rec}$	HKD	3,0	3,0	3,0	3,0	-	3,9	4,3	3,9	6,1	8,5	12,6	17,2
	HKD-S, HKD-E	2,1	-	-	-	3,3	3,3	3,6	3,3	5,1	7,1	12,6	17,2
	HKD-SR, HKD-ER	2,1	-	-	-	3,3	3,3	-	-	5,1	7,1	12,6	17,2
Shear $V_{Rd}$	HKD	2,9	3,0	3,0	3,0	-	4,9	5,2	5,7	6,3	10,5	19,3	28,3
	HKD-S, HKD-E	2,8	-	-	-	2,8	3,9	4,2	3,9	4,6	8,1	12,5	19,8
	HKD-SR, HKD-ER	2,9	-	-	-	3,0	3,9	-	-	4,9	8,8	15,1	24,0

a) With overall partial safety factor for action  $\gamma = 1,4$ . The partial safety factors for action depend on the type of loading and shall be taken from national regulations.

## Materials

### Mechanical properties

Anchor size			M6	M8	M10	M12	M16	M20
Nominal tensile strength	$f_{uk}$	HKD	570	570	570	570	640	590
		HKD-S, HKD-E	560	560	510	510	-	460
		HKD-SR, HKD-ER	540	540	540	540	-	540
Yield strength	$f_{yk}$	HKD	460	460	460	480	510	470
		HKD-S, HKD-E	440	440	410	410	-	375
		HKD-SR, HKD-ER	355	355	355	355	-	355
Stressed cross-section	$A_s$	HKD	20,7	26,7	32,7	60,1	105	167
		HKD-S, HKD-E	20,9	26,1	28,8	58,7	-	163
		HKD-SR, HKD-ER						
Moment of resistance	W	HKD	32,3	54,6	82,9	184	431	850
		HKD-S, HKD-E	50	79	110	264	602	1191
		HKD-SR, HKD-ER						
Char. bending resistance for rod or bolt	$M^{0}_{Rk,s}$	With 5.8 Gr. Steel	7,6	18,7	37,4	65,5	167	325
		HKD-SR HKD-ER with A4-70	11	26	52	92	187	454

### Material quality

Part	Material	
Anchor body	HKD	Cold formed steel / galvanised to min. 5 $\mu$ m
	HKD-S, HKD-E	Steel Fe/Zn5 galvanised to min. 5 $\mu$ m
	HKD-SR, HKD-ER	Stainless steel, 1.4401, 1.4404, 1.4571
Expansion plug	HKD	Cold formed steel
	HKD-S, HKD-E	Cold formed steel
	HKD-SR, HKD-ER	Stainless steel, 1.4401, 1.4404, 1.4571

### Anchor dimensions of HKD, HKD-S, HKD-E, HKD-SR, HKD-ER

Anchor size	Hilti technical data				ETA-02/0032, issued 2015-01-07								
	M6x25	M8x25	M10x25	M12x25	M6x30	M8x30	M8x40	M10x30	M10x40	M12x50	M16x65	M20x80	
Eff. anchorage depth $h_{ef}$ [mm]	25	25	25	25	30	30	40	30	40	50	65	80	
Anchor diameter $d_1$ [mm]	7,9	9,95	11,9	14,9	8	9,95	9,95	11,8	11,95	14,9	19,75	24,75	
Plug diameter $d_2$ [mm]	5,1	6,35	8,1	9,7	5	6,5	6,35	8,2	8,2	10,3	13,8	16,4	
Plug length $l_1$ [mm]	10	7	7	7,2	15	12	16	12	16	20	29	30	

#### Anchor body

HKD

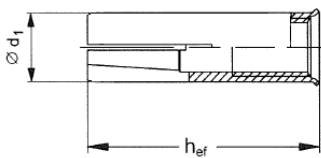

HKD-S and HKD-SR

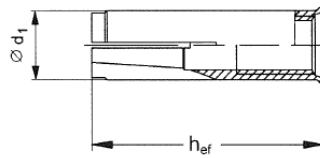

#### Expansion plugs

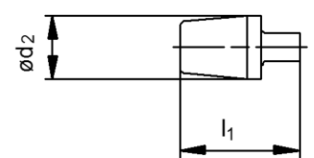
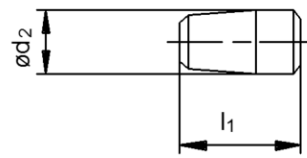

HKD-E and HKD ER

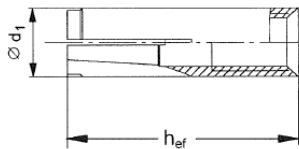

### Setting information

#### Setting details

Anchor size	Hilti technical data				ETA-02/0032, issued 2015-01-07								
	M6x25	M8x25	M10x25	M12x25	M6x30	M8x30	M8x40	M10x30 <sup>a)</sup>	M10x40	M12x50	M16x65	M20x80	
Effective embedment depth $h_{ef}$ [mm]	25	25	25	25	30	30	40	30	40	50	65	80	
Nominal diameter of drill bit $d_o$ [mm]	8	10	12	15	8	10	10	12	12	15	20	25	
Cutting diameter of drill bit $d_{cut} \leq$ [mm]	8,45	10,5	12,5	15,5	8,45	10,5	10,5	12,5	12,5	15,5	20,5	25,5	
Depth of drill hole $h_1 \geq$ [mm]	27	27	27	27	32	33	43	33	43	54	70	85	
Screwing depth $l_{s,min}$ [mm]	6	8	10	12	6	8	8	10	10	12	16	20	
Thread engagement depth $l_{s,max}$ [mm]	12	11,5	12	12	12,5	14,5	17,5	12,7	18	23,5	30,5	42	
Diameter of clearance hole in the fixture $d_f \leq$ [mm]	7	9	12	14	7	9	9	12	12	14	18	22	
Max. torque moment $T_{ins}$ [Nm]	4	8	15	35	4	8	8	15	15	35	60	100	

a) With anchor size M10x30 only threaded rod is to be used.

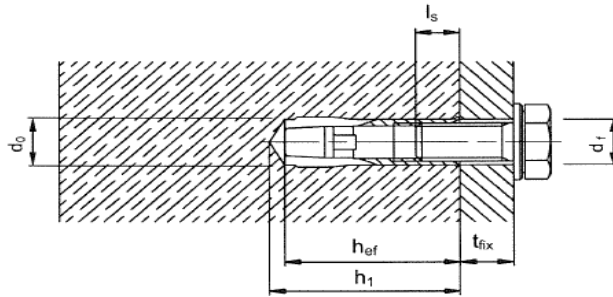

### Installation equipment

Anchor size		M6	M8	M10	M10	M12	M16
Rotary hammer for setting		TE 1 – TE 3				TE 16 – TE 50	
Machine setting tool	HSD-M	6x25/30	8x25/30	10x25/30	10x40	12x50	16x65
Hand setting tool	HSD-G HSD-M	6x25/30	8x25/30	10x25/30	10x40	12x50	16x65
Other tools		hammer, torque wrench, blow up pump					

### Setting parameters

Anchor size	Hilti technical data	ETA-02/0032, issued 2015-01-07											
		M6x25	M8x25	M10x25	M12x25	M6x30	M8x30	M8x40	M10x30	M10x40	M12x50	M16x65	M20x80
Minimum base material thickness	$h_{min}$ [mm]	100	100	100	100	100	100	100	100	100	100	130	160
Minimum spacing and minimum edge distance HKD-S (R) / HKD-E (R)	$s_{min}$ [mm]	60	60	60	60	60	60	80	60	80	125	130	160
	$c_{min}$ [mm]	88	88	88	88	105	105	140	105	140	175	230	280
Minimum spacing HKD	$s_{min}$ [mm]	80	80	80	80	60	60	80	60	80	125	130	160
	$c \geq$ [mm]	140	140	140	140	105	105	140	105	140	175	230	280
Minimum edge distance HKD	$c_{min}$ [mm]	100	100	100	100	80	80	140	80	140	175	230	280
	$s \geq$ [mm]	150	150	150	150	120	120	80	120	80	125	130	160
Critical spacing and edge distance for splitting failure HKD	$s_{cr,sp}$ [mm]	200	200	200	200	210	210	280	210	280	350	455	560
	$c_{cr,N}$ [mm]	100	100	100	100	105	105	140	105	140	175	227	280
Critical spacing and edge distance for concrete cone failure HKD / HKDS-(R) / HKD-E(R)	$s_{cr,N}$ [mm]	80	80	80	80	90	90	120	90	120	150	195	240
	$c_{cr,N}$ [mm]	40	40	40	40	45	45	60	45	60	75	97	120
Critical spacing and edge distance for splitting failure HKD-S(R) / HKD-E(R)	$s_{cr,sp}$ [mm]	176	176	176	176	210	210	280	210	280	350	455	560
	$c_{cr,N}$ [mm]	88	88	88	88	105	105	140	105	140	175	227	280

For spacing (edge distance) smaller than critical spacing (critical edge distance) the design loads have to be reduced.

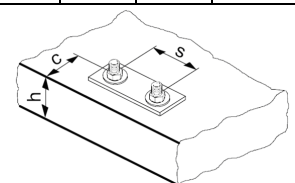



## Setting instruction

\*For detailed information on installation see instruction for use given with the package of the product.

Setting instruction	
<p><b>1. Drilling</b></p>	<p><b>2. Cleaning</b></p>
<p><b>3. Inserting the anchor</b></p>	<p><b>4. Setting tools</b></p>
<p><b>5. Inserting the tools</b></p>	<p><b>6. Inserting the tools</b></p>
<p><b>7. Attaching the belonging washer</b></p>	

# HKD Flush anchor

Everyday standard manual set flush anchor for redundant fastening applications





Chemical anchors





Flush



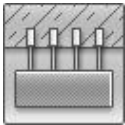

Mechanical anchors

Plastic/Light duty metal anchors

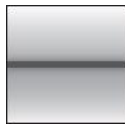
Insulation anchors

Anchor version	Benefits
 HKD (M6-M16)	<ul style="list-style-type: none"> <li>- Simple and well proven</li> <li>- Approved, tested and confirmed by everyday jobsite experience</li> <li>- Reliable setting thanks to simple visual check</li> <li>- Versatile</li> <li>- For medium-duty fastening with bolts or threaded rods</li> <li>- Available in various materials and sizes for maximized coverage of possible applications</li> </ul>
 HKD-woL (M6-M16)	
 HKD-S(R) (M6-M12)	
 HKD-E(R) (M6-M12)	

Base material	Load conditions
 Concrete (non-cracked)	 Fire resistance
 Concrete (cracked)	
 Redundant fastening	
 Pre-stressed hollow core slabs	
 Static/quasi-static	

Other information			
 European Technical Assessment	 CE conformity	 Sprinkler approved	 Corrosion resistance

## Approvals / certificates

Description	Authority / Laboratory	No. / date of issue
European Technical Assessment <sup>a)</sup>	DIBt, Berlin	ETA-06/0047 / 2016-02-08
Fire test report	DIBt, Berlin	ETA-06/0047 / 2016-02-08
Assessment report fire	Warringtonfire	WF 327804/A / 2013-07-10

a) All data given in this section according to ETA-06/0047, issue 2016-02-08.

## Static and quasi-static resistance for

### All data in this section applies to:

- Correct setting (See setting instruction)
- No edge distance and spacing influence
- Minimum base material thickness
- Concrete C 20/25,  $f_{ck,cube} = 25 \text{ N/mm}^2$
- Anchors in redundant fastening

### Effective anchorage depth for static

Anchor size	M6	M6	M8	M8	M8	M10	M10	M10	M12	M12	M16
Eff. anchorage depth range $h_{ef}$ [mm]	25	30	25	30	40	25	30	40	25	50	65

### Characteristic resistance, all load directions

Anchor size			M6x25	M6x30	M8x25	M8x30	M8x40	M10x25	M10x30	M10x40	M12x25	M12x50	M16x65
Load $F_{Rk}$	HKD / HKD-woL	[kN]	2,0	-	3,0	5,0	5,0	4,0	5,0	7,5	4,0	9,0	16,0
	HKD-S/ HKD-E		-	3,0	-	3,0	5,0	-	4,0	6,0	-	6,0	-
	HKD-SR/ HKD-ER		-	3,0	-	3,0	-	-	-	6,0	-	6,0	-

### Design resistance, all load directions

Anchor size			M6x25	M6x30	M8x25	M8x30	M8x40	M10x25	M10x30	M10x40	M12x25	M12x50	M16x65
Load $F_{Rd}$	HKD / HKD-woL	[kN]	1,3	-	2,0	2,8	3,3	2,2	3,3	5,0	2,7	6,0	10,7
	HKD-S/ HKD-E		-	2,0	-	2,0	3,3	-	2,7	4,0	-	4,0	-
	HKD-SR/ HKD-ER		-	2,0	-	2,0	-	-	-	4,0	-	4,0	-

### Recommended loads <sup>a)</sup>, all load directions

Anchor size			M6x25	M6x30	M8x25	M8x30	M8x40	M10x25	M10x30	M10x40	M12x25	M12x50	M16x65
Load $F_{Rec}$	HKD / HKD-woL	[kN]	1,0	-	1,4	2,0	2,4	1,6	2,4	3,6	1,9	4,3	7,6
	HKD-S/ HKD-E		-	1,4	-	1,4	2,4	-	1,9	2,9	-	2,9	-
	HKD-SR/ HKD-ER		-	1,4	-	1,4	-	-	-	2,9	-	2,9	-

a) With overall partial safety factor for action  $\gamma = 1,4$ . The partial safety factors for action depend on the type of loading and shall be taken from national regulations.

### Requirements for redundant fastening

The definition of redundant fastening according to Member States is given in the ETAG 001 Part six, Annex 1. In absence of a definition by a Member State the following default values may be taken.

Minimum number of fixing points	Minimum number of anchors per fixing point	Maximum design load of action $N_{Sd}$ per fixing point <sup>a)</sup>
3	1	2 kN
4	1	3kN

a) The value for maximum design load of actions per fastening point  $N_{Sd}$  is valid in general that means all fastening points are considered in the design of the redundant structural system. The value  $N_{Sd}$  may be increased if the failure of one (=most unfavorable) fixing point is taken into account in the design (serviceability and ultimate limit state) of the structural system e.g. suspended ceiling.

## Materials

### Mechanical properties

Anchor size			M6	M8	M10	M10	M12
Nominal tensile strength	$f_{uk}$	HKV / HKD-woL	570	570	570	570	640
		HKD-S, HKD-E	560	560	510	510	-
		HKD-SR, HKD-ER	540	540	540	540	-
Yield strength	$f_{yk}$	HKV / HKD-woL	460	460	460	480	510
		HKD-S, HKD-E	440	440	410	410	-
		HKD-SR, HKD-ER	355	355	355	355	-
Stressed cross-section	$A_s$	HKV / HKD-woL	20,7	26,7	32,7	60,1	105
		HKD-S, HKD-E	20,9	26,1	28,8	58,7	-
		HKD-SR, HKD-ER					
Moment of resistance	W	HKV / HKD-woL	32,3	54,6	82,9	184	431
		HKD-S, HKD-E	50	79	110	264	-
		HKD-SR, HKD-ER					
Char. bending resistance for rod or bolt	$M^{0}_{Rk,s}$	With 5.8 Gr. Steel	7,6	18,7	37,4	65,5	167
		HKD-SR	11	26	52	92	-
		HKD-ER with A4-70					

### Material quality

Part	Material	
Anchor body	HKV / HKD-woL	Cold formed steel-galvanized to $\geq 5 \mu\text{m}$
	HKD-S, HKD-E	Steel Fe/Zn5, galvanized to $\geq 5 \mu\text{m}$
	HKD-SR, HKD-ER	Stainless steel, 1.4401, 1.4404, 1.4571 EN 10088-3:2014
Expansion plug	HKV / HKD-woL	Cold formed steel
	HKD-S, HKD-E	Cold formed steel
	HKD-SR, HKD-ER	Stainless steel, 1.4401, 1.4404, 1.4571 EN 10088-3:2014

### Anchor dimensions of HKD, HKD-S, HKD-E, HKD-SR, HKD-ER

Anchor size			M6x25	M8x25	M10x25	M12x25	M6x30	M8x30	M8x40	M10x30	M10x40	M12x50	M16x65
Anchor length	$l_G$	[mm]	25	30	25	30	40	25	30	40	25	50	65
Anchor diameter	$\varnothing_{d1}$	[mm]	7,9	8	9,95	9,95	9,95	11,9	11,8	11,95	14,9	14,9	19,75
Plug diameter	$\varnothing_{d2}$	[mm]	5,1	5	6,35	6,5	6,35	8,1	8,2	8,2	9,7	10,3	13,8
Plug length	$l_1$	[mm]	10	15	7	12	16	7	12	16	7,2	20	29

#### Anchor body

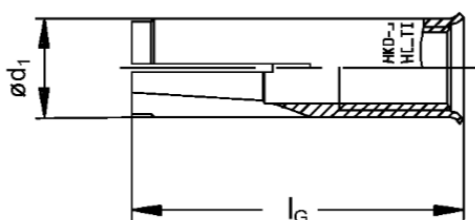

#### Expansions plugs

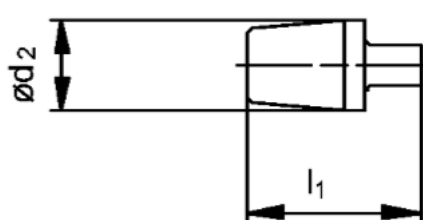

## Setting information

### Setting details

Anchor size		M6x25	M6x30	M8x25 <sup>a)</sup>	M8x30	M8x40	M10x25 <sup>a)</sup>	M10x30 <sup>a)</sup>	M10x40	M12x25 <sup>a)</sup>	M12x50	M16x65
Effective anchorage depth	$h_{ef}$ [mm]	25	30	25	30	40	25	30	40	25	50	65
Nominal diameter of drill bit	$d_0$ [mm]	8	8	10	10	10	12	12	12	15	15	20
Thread diameter	$d$ [mm]	6	6	8	8	8	10	10	10	12	12	16
Depth of drill hole	$h_1$ [mm]	27	32	27	33	43	27	33	43	27	54	70
Diameter of clearance hole in the fixture	$d_f$ [mm]	7	7	9	9	9	12	12	12	14	14	18
Torque moment	$T_{inst}$ [mm]	4	4	8	8	8	15	15	15	35	35	60
Screwing depth	$l_{s,min}$ [mm]	6	6	8	8	8	10	10	10	12	12	16
	$l_{s,max}$ [mm]	12	12,5	11,5	14,5	17,5	12	12,7	18	12	23,5	30,5

a) With anchor size M8x25, M10x25, M10x30 and M12x25 only threaded rod are to be used.

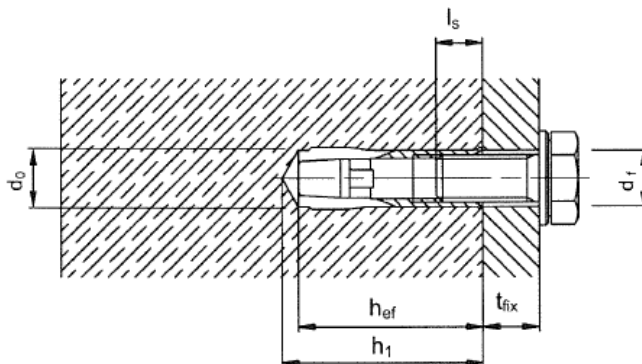

### Installation equipment

Anchor size		M6x25	M8x25	M10x25	M12x25	M6x30	M8x30	M8x40	M10x30	M10x40	M12x50	M16x65
Rotary hammer for setting		TE 2 – TE 16									TE16–TE50	
Machine setting tool	HSD-M	6x25/30	8x25/30	8x40	10x25/30	10x40	12x25	12x50	16x65			
Hand setting tool	HSD-G											
Other tools		Hammer, torque wrench, blow out pump										

### Setting parameters

Anchor size		M6x25	M6x30	M8x25 <sup>a)</sup>	M8x30	M8x40	M10x25 <sup>a)</sup>	M10x30 <sup>a)</sup>	M10x40	M12x25 <sup>a)</sup>	M12x50	M16x65
<b>Minimum spacing and minimum edge distance for HKD / HKD-woL</b>												
Minimum thickness of concrete member	$h_{min}$ [mm]	100	-	100	100	100	100	100	100	100	100	120
Minimum spacing	$s_{min}$ [mm]	80	-	80	60	80	80	60	80	80	125	130
	$c \geq$ [mm]	140	-	140	105	140	140	105	140	140	175	230
Minimum edge distance	$c_{min}$ [mm]	100	-	100	80	140	100	80	140	100	175	230
	$s \geq$ [mm]	150	-	150	120	80	150	120	80	150	125	130
<b>Minimum thickness of concrete member for HKD / HKD-woL</b>												
Minimum thickness of concrete member	$h_{min}$ [mm]	80	-	80	80	80	80	80	80	80	-	-
Minimum spacing	$s_{min}$ [mm]	200	-	200	200	200	200	200	200	200	-	-
Minimum edge distance	$c_{min}$ [mm]	150	-	150	150	150	150	150	150	150	-	-
<b>Minimum spacing and minimum edge distance for HKD-S(R) / HKD-S(R)</b>												
Minimum thickness of concrete member	$h_{min}$ [mm]	-	100	-	100	100	-	100	100	-	100	-
Minimum spacing	$s_{min}$ [mm]	-	60	-	60	80	-	60	80	-	125	-
Minimum edge distance	$c_{min}$ [mm]	-	105	-	105	140	-	105	140	-	175	-
<b>Minimum thickness of concrete member for HKD-S(R) / HKD-S(R)</b>												
Minimum thickness of concrete member	$h_{min}$ [mm]	-	80	-	80	80	-	80	80	-	-	-
Diameter of clearance hole in the fixture	$s_{min}$ [mm]	-	200	-	200	200	-	200	200	-	-	-
Torque moment	$c_{min}$ [mm]	-	150	-	150	150	-	150	150	-	-	-

For spacing (edge distance) smaller than critical spacing (critical edge distance) the design loads have to be reduced.

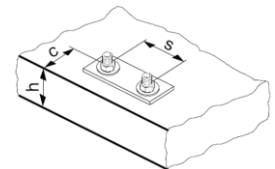

Setting instruction

\*For detailed information on installation see instruction for use given with the package of the product.

Setting instruction	
<p><b>1. Drilling</b></p>	<p><b>2. Cleaning</b></p>
<p><b>3. Inserting the anchor</b></p>	<p><b>4. Setting tools</b></p> <p>HSD-G M8x30 </p> <p>HSD-M M8x30 </p>
<p><b>5. Inserting the tools</b></p>	<p><b>6. Inserting the tools</b></p>
<p><b>7. Attaching the belonging washer</b></p> <p><math>T_{inst}</math></p>	<p><b>8.</b></p>



## Setting instruction with the stop drill bit TE-CX-HKD only

### 1. Positioning pre-stressed steel



### 2. Marking pre-stressed steel position



### 3. Marking pre-stressed steel position



### 4. Drilling

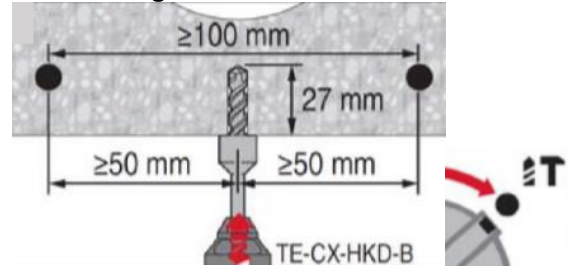

### 5. Cleaning

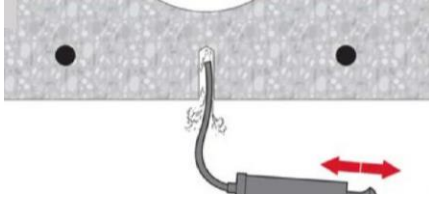

### 6. Inserting the anchor

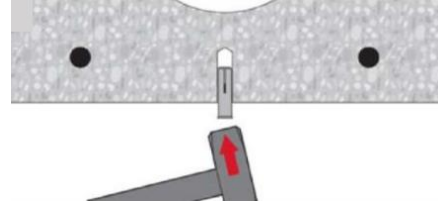

### 7. Setting tools

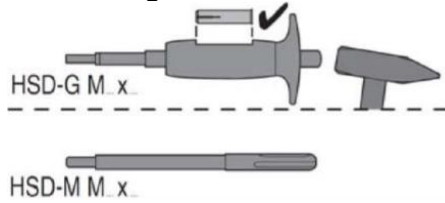

### 8. Inserting the tools

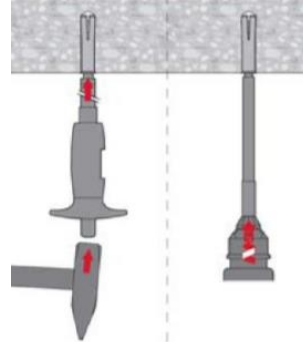

### 9. Inserting the tools

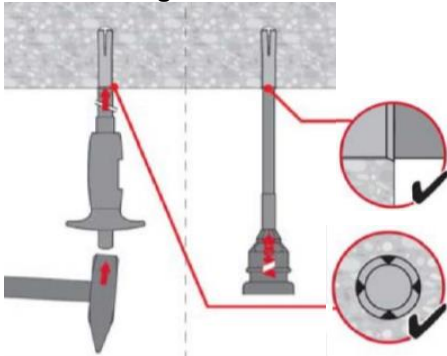

### 10. Attaching the belonging washer

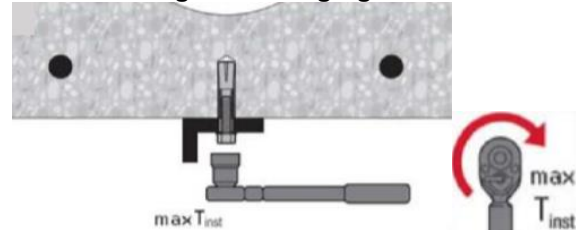

### 11.

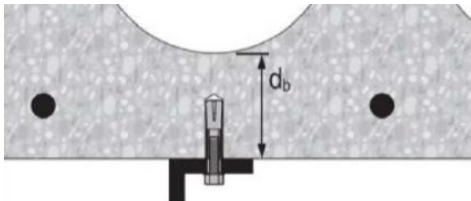



Chemical anchors

Flush

Mechanical anchors

Plastic/Light duty metal anchors

Insulation anchors

# HKV Flush anchors

## Economical manual set flush anchor

### Anchor version



HKV  
(M6-M16)

### Benefits

- Simple and well proven
- Approved, tested and confirmed by every day jobsite experience
- Reliable setting thanks to simple visual check
- Versatile
- For medium-duty fastening with bolts or threaded rods
- Available in various materials and sizes for maximized coverage of possible applications

### Base material



Concrete  
(non-cracked)

### Basic loading data (for a single anchor)

#### All data in this section applies to:

- Correct setting (See setting instruction)
- No edge distance and spacing influence
- Concrete as specified in the table
- Minimum base material thickness
- Concrete C 20/25,  $f_{ck,cube} = 25 \text{ N/mm}^2$
- Screw or rod with steel grade 5.8 (carbon steel) and / or A4-70 (stainless steel)

#### Effective anchorage depth

Anchor size	Metric	M6	M8	M10	M10	M12	M16
	Imperial	1/4	5/16	3/8	3/8	1/2	-
Eff. anchorage depth range	$h_{ef}$ [mm]	25	30	30	40	50	65

#### Characteristic resistance

Anchor size	Metric	M6	M8	M10	M10	M12	M16
	Imperial	1/4	5/16	3/8	3/8	1/2	-
Tension $N_{Rk}$	HKV [kN]	4,2	5,9	5,9	9,1	12,7	26,5
Shear $V_{Rk}$	HKV [kN]	5,0	8,6	10,0	11,0	18,3	33,8

#### Design resistance

Anchor size	Metric	M6	M8	M10	M10	M12	M16
	Imperial	1/4	5/16	3/8	3/8	1/2	-
Tension $N_{Rd}$	HKV [kN]	2,8	3,9	3,9	6,1	8,5	17,6
Shear $V_{Rd}$	HKV [kN]	5,0	8,6	8,0	8,0	14,6	27,0

### Recommended loads <sup>a)</sup>

Anchor size	Metric		M6	M8	M10	M10	M12	M16
	Imperial		1/4	5/16	3/8	3/8	1/2	-
Tension $N_{Rec}$	HKV	[kN]	2,0	2,8	2,8	4,3	6,0	12,6
Shear $V_{Rec}$	HKV	[kN]	2,9	4,9	5,7	5,7	10,5	19,3

a) With overall partial safety factor for action  $\gamma = 1,4$ . The partial safety factors for action depend on the type of loading and shall be taken from national regulations. According to ETAG 001, the partial safety factor is  $\gamma_G = 1,35$  for permanent actions and  $\gamma_Q = 1,5$  for variable actions.

### Materials

#### Mechanical properties

Anchor size	Metric		M6	M8	M10	M10	M12	M16
	Imperial		1/4	5/16	3/8	3/8	1/2	-
Nominal tensile strength	$f_{uk}$	[N/mm <sup>2</sup> ]	570	570	570	570	570	640
Yield strength	$f_{yk}$	[N/mm <sup>2</sup> ]	460	460	460	460	460	510
Stressed cross-section	$A_s$	[mm <sup>2</sup> ]	20,7	26,7	32,7	32,7	60,1	105
			17,3	27,46	39,9	39,9	70,6	-
Moment of resistance	W	[mm <sup>3</sup> ]	32,3	54,6	82,9	82,9	184	431
			28,2	55,8	97,4	97,4	229,8	-
Char. bending resistance for rod or bolt with 5.8 steel grade	$M^{0}_{Rk,s}$	[Nm]	7,6	18,7	37,4	37,4	65,5	167
			10,4	16,5	23,9	24,5	42,4	-

#### Material quality

Part	Material
Anchor body	Steel Fe/Zn5 galvanized to min. 5 $\mu$ m
Expansion plug	Steel material

#### Anchor dimension

Anchor size	Metric		M6	M8	M10	M10	M12	M16
	Imperial		1/4	5/16	3/8	3/8	1/2	-
Effective anchorage depth	$h_{ef}$	[mm]	25	30	30	40	50	65
Anchor diameter	$d_1$	[mm]	7,9	9,95	11,8	11,95	14,9	19,75
				9,9	11,9		15,85	-
Diameter of cone bolt	$d_2$	[mm]	5,1	6,5	8,2	8,2	10,3	13,8
				6,35		7,86	10,2	-
Length of expansion sleeve	$l_1$	[mm]	10	12	12	16	20	29
						16,2		-

### Anchor body

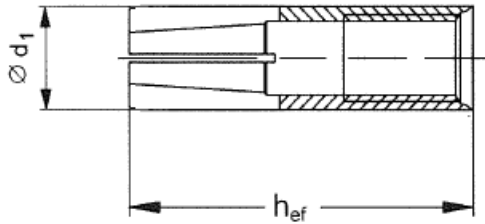

### Expansion plugs

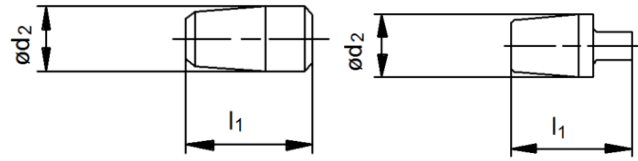

### Setting information

#### Setting details

Anchor size	Metric	M6	M8	M10	M10	M12	M16
	Imperial	1/4	5/16	3/8	3/8	1/2	-
Effective anchorage depth	$h_{ef}$ [mm]	25	30	30	40	50	65
Nominal diameter of drill bit	$d_0$ [mm]	8	10	12	12	15 16	20
Cutting diameter of drill bit	$d_{cut} \leq$ [mm]	8,45	10,5	13 12,5	12,5	15,5 16,5	20,5
Depth of drill hole	$h_1 \geq$ [mm]	27	33	33	43	54	70
Diameter of clearance hole in the fixture	$d_f \leq$ [mm]	7	9	12	12	14	18
Torque moment	$T_{inst}$ [Nm]	4	8	15	15	35	60
Screwing depth	$l_{s,min}$ [mm]	6	8	10	10	12	16
	$l_{s,max}^{a)}$ mm]	10	12	10,5	15,5	20,0	25,5

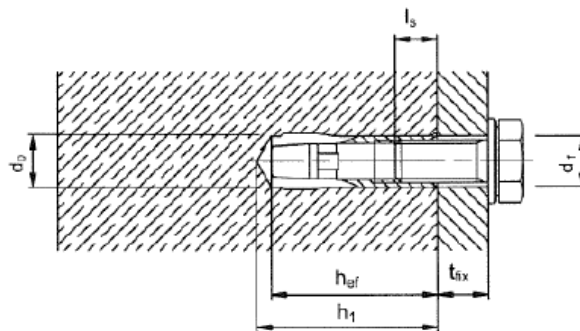

#### Setting parameters

Anchor size	Metric	M6	M8	M10	M10	M12	M16
	Imperial	1/4	5/16	3/8	3/8	1/2	-
Minimum base material thickness	$h_{min} \geq$ [mm]	100	100	100	100	100	130
Minimum spacing	$s_{min} \geq$ [mm]	200	200	200	200	200	260
Minimum edge distance	$c_{min} \geq$ [mm]	150	150	150	150	150	195

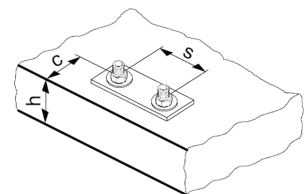

### Installation equipment

Anchor size	Metric	M6	M8	M10	M10	M12	M16
	Imperial	1/4	5/16	3/8	3/8	1/2	-
Rotary hammer for setting	TE 1 – TE 30				TE 16 – TE 50		
	TE 1 – TE 30						-
Machine setting tool	HSD-M	6x25/30	8x25/30	10x25/30	10x40	12x50	16x65
		1/4x25	5/16x30	3/8x30	3/8x40	1/2x50	-
Hand setting tool	HSD-G	6x25/30	8x25/30	10x25/30	10x40	12x50	16x65
		1/4x25	5/16x30	3/8x30	3/8x40	1/2x50	-
Other tools	hammer, torque wrench, blow out pump						

### Setting instruction

\*For detailed information on installation see instruction for use given with the package of the product.

Setting instruction	
<b>1. Drilling</b> 	<b>2. Cleaning</b> 
<b>3. Inserting the anchor</b> 	<b>4. Setting tools</b> 
<b>5. Inserting the tools</b> 	<b>6. Inserting the tools</b> 
<b>7. Attaching the belonging washer</b> 	<b>8.</b> 

# HRD Plastic frame anchors





Everyday standard plastic frame anchor for redundant fastening applications









Chemical anchors

Mechanical anchors

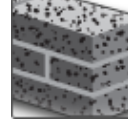
Plastic/Light duty metal anchors

Insulation anchors

Anchor version	Benefits
 HRD-C HRD-CR (M8)	<ul style="list-style-type: none"> <li>- Innovative screw design for better hold</li> <li>- Suitable on practically all base materials</li> <li>- Flexible embedment depth (approved at 50mm and 70mm)</li> <li>- Suitable for fastening thicknesses up to 260mm</li> <li>- Available in 4 different materials for optimum suitability in all corrosive environments</li> <li>- Pre-assembled for optimum handling and fastening quality</li> </ul>
 HRD-C HRD-CR HRD-CR2 (M10)	
 HRD-H HRD-HR HRD-HR2 HR-HF (M10)	
 HRD-K HRD-KR HRD-KR2 (M10)	
 HRD-P HRD-PR HRD-PR2 (M10)	

Base material							
							
Concrete (non-cracked)	Concrete (cracked)	Solid brick	Hollow brick	Autoclaved aerated concrete	Drywall	Prestressed hollow core slabs	Window frame

Load conditions	Other information
 Tensile zone <sup>a)</sup>	 European Technical Approval
 Fire resistance	
	 CE conformity

a) Redundant fastening only

### Approvals / certificates

Description	Authority / Laboratory	No./ date of issue
European technical approval <sup>a)</sup>	DIBt, Berlin	ETA-07/0219 / 2018-06-28
Fire test report	MFPA, Leipzig	GS 3.2/10-157-1/ 2010-09-02
Window frame report <sup>b)</sup>	Ift, Rosenheim	Ift report 105 33035 / 2007-07-09

a) All data given in this section according ETA-07/0219, issue 2017-09-19. The anchor is to be used only for redundant fastening for non-structural applications.

b) Only available for HRD 8



## Basic loading data

### All data in this section applies to:

- Correct setting (See setting instruction)
- No edge distance and spacing influence
- Base material as specified in the table
- Minimum base material thickness
- Steel failure
- Shear without lever arm
- Anchor in redundant fastening

The additional Hilti recommended data, not part of the approval

### Characteristic resistance

Anchor size		HRD 8	HRD 10		
$h_{nom}$ [mm]		50	50	70	90
Concrete C12/15	$N_{Rk}$ [kN]	2,0	3,0	6,0	-
	$N_{Rk}$ [kN]	6,9 / 6,6 <sup>b)</sup>	10,6 / 10,1 <sup>b)</sup> / 11,1 <sup>c)</sup>		-
Concrete C16/20 – C 50/60	$F_{Rk}$ [kN]	3,0	4,5	8,5	-
	$V_{Rk}$ [kN]	6,9 / 6,6 <sup>b)</sup>	10,6 / 10,1 <sup>b)</sup> / 11,1 <sup>c)</sup>		-
Solid clay brick Mz 2,0 DIN V 105-100/EN 771-1	$f_b \geq 20$ N/mm <sup>2</sup> $F_{Rk}$ [kN]	1,5	3,0	f)	-
			4,5 <sup>d)</sup>		
Solid sand-lime brick KS 2,0 DIN V 106 /EN 771-2	$f_b \geq 10$ N/mm <sup>2</sup> $F_{Rk}$ [kN]	1,2	2,0	f)	-
			3,0 <sup>d)</sup>		
Solid sand-lime brick KS 2,0 DIN V 106 /EN 771-2	$f_b \geq 20$ N/mm <sup>2</sup> $F_{Rk}$ [kN]	2,5	3,0	f)	-
			4,5 <sup>d)</sup>		
Solid sand-lime brick KS 2,0 DIN V 106 /EN 771-2	$f_b \geq 10$ N/mm <sup>2</sup> $F_{Rk}$ [kN]	2,0	2,0	f)	-
			3,0 <sup>d)</sup>		
Lightweight solid block Vbl 0,9 DIN V 18151-100/EN 771	$f_b \geq 20$ N/mm <sup>2</sup> $F_{Rk}$ [kN]	-	3,5	f)	-
			6,0 <sup>d)</sup>		
	$f_b \geq 10$ N/mm <sup>2</sup> $F_{Rk}$ [kN]		-		
			4,5 <sup>d)</sup>		
	$f_b \geq 6$ N/mm <sup>2</sup> $F_{Rk}$ [kN]	0,5	-	-	-
Ital. solid brick Tufo	$f_b \geq n/a$ $F_{Rk}$ [kN]	1,4	-	-	-
Hollow clay brick Hz B 12/1,2 Brick <b>A</b> <sup>e)</sup>	$f_b \geq 12$ N/mm <sup>2</sup> $F_{Rk}$ [kN]	0,5	-	-	-
Vertic. perforated clay brick Hz 1,2-2DF Brick <b>F</b> <sup>e)</sup>	$f_b \geq 8$ N/mm <sup>2</sup> $F_{Rk}$ [kN]	-	1,5	-	-
	$f_b \geq 10$ N/mm <sup>2</sup> $F_{Rk}$ [kN]	-	2,0	-	-
	$f_b \geq 12$ N/mm <sup>2</sup> $F_{Rk}$ [kN]	-	2,0	-	-
Vertic. perforated clay brick Hz 1,0-2DF Brick <b>G</b> <sup>e)</sup>	$f_b \geq 8$ N/mm <sup>2</sup> $F_{Rk}$ [kN]	-	0,4	0,75	-
	$f_b \geq 10$ N/mm <sup>2</sup> $F_{Rk}$ [kN]	-	0,5	0,9	-
	$f_b \geq 12$ N/mm <sup>2</sup> $F_{Rk}$ [kN]	-	0,6	0,9	-
	$f_b \geq 20$ N/mm <sup>2</sup> $F_{Rk}$ [kN]	-	0,9	1,5	-
Vertic. perforated clay brick Hz 1,0-2DF Brick <b>H</b> <sup>e)</sup>	$f_b \geq 28$ N/mm <sup>2</sup> $F_{Rk}$ [kN]	-	2,0	2,5	-
	$f_b \geq 50$ N/mm <sup>2</sup> $F_{Rk}$ [kN]	-	3,0	3,5	-
Vertic. perforated clay brick Poroton T8 Brick <b>M</b> <sup>e)</sup>	$f_b \geq 6$ N/mm <sup>2</sup> $F_{Rk}$ [kN]	-	0,75	1,5	-
Vertic. perforated clay brick Hz 1,0-9DF Brick <b>L</b> <sup>e)</sup>	$f_b \geq 8$ N/mm <sup>2</sup> $F_{Rk}$ [kN]	-	1,2	1,5	-
	$f_b \geq 10$ N/mm <sup>2</sup> $F_{Rk}$ [kN]	-	1,5	1,5	-
	$f_b \geq 12$ N/mm <sup>2</sup> $F_{Rk}$ [kN]	-	1,5	2,0	-
	$f_b \geq 16$ N/mm <sup>2</sup> $F_{Rk}$ [kN]	-	2,0	3,0	-

b) Values for hot-dipped galvanized carbon steel.

c) Values for stainless steel.

d) Valid for edge distance  $c \geq 150$ mm, intermediate values can be interpolated.

e) Specification on hollow base material brick types see separate table below.

f) Data can be determined by job-site testing, data for  $h_{nom}=50$ mm can be applied.

### Characteristic resistance

Anchor size			HRD 8		HRD 10	
			50	50	70	90
		$h_{nom}$ [mm]				
Hollow sand-lime brick KSL 12/1,4 Brick <b>O<sup>e)</sup></b>	$f_b \geq 12 \text{ N/mm}^2$	$F_{Rk}$ [kN]	0,75	-	-	-
Vertic. perforated clay brick Hz 1,6-2DF Brick <b>P<sup>e)</sup></b>	$f_b \geq 8 \text{ N/mm}^2$	$F_{Rk}$ [kN]	-	1,5	-	-
	$f_b \geq 10 \text{ N/mm}^2$	$F_{Rk}$ [kN]	-	1,5	-	-
	$f_b \geq 12 \text{ N/mm}^2$	$F_{Rk}$ [kN]	-	2,0	-	-
Vertic. perforated clay brick Hz 1,6-2DF Brick <b>Q<sup>e)</sup></b>	$f_b \geq 8 \text{ N/mm}^2$	$F_{Rk}$ [kN]	-	-	2,0	-
	$f_b \geq 10 \text{ N/mm}^2$	$F_{Rk}$ [kN]	-	-	2,5	-
	$f_b \geq 12 \text{ N/mm}^2$	$F_{Rk}$ [kN]	-	-	3,0	-
Vertic. perforated clay brick KSL R 1,6-16DF Brick <b>R<sup>e)</sup></b>	$f_b \geq 8 \text{ N/mm}^2$	$F_{Rk}$ [kN]	-	0,9	1,2	-
	$f_b \geq 10 \text{ N/mm}^2$	$F_{Rk}$ [kN]	-	1,2	1,5	-
	$f_b \geq 12 \text{ N/mm}^2$	$F_{Rk}$ [kN]	-	1,5	2,0	-
	$f_b \geq 16 \text{ N/mm}^2$	$F_{Rk}$ [kN]	-	2,0	2,5	-
Lightweight hollow brick Hbl B 2/0,8 Brick <b>S<sup>e)</sup></b>	$f_b \geq 2 \text{ N/mm}^2$	$F_{Rk}$ [kN]	0,30	-	-	-
Lightweight concrete hollow block Hbl 1,2-12DF Brick <b>T<sup>e)</sup></b>	$f_b \geq 8 \text{ N/mm}^2$	$F_{Rk}$ [kN]	-	0,5	0,75	-
	$f_b \geq 10 \text{ N/mm}^2$	$F_{Rk}$ [kN]	-	1,2	2,0	-
Ital. hollow brick Poroton P700 Brick <b>N<sup>e)</sup></b>	$f_b \geq 20 \text{ N/mm}^2$	$F_{Rk}$ [kN]	1,5	-	-	-
Ital. hollow brick Doppio Uni Brick <b>C+I<sup>e)</sup></b>	$f_b \geq 28 \text{ N/mm}^2$	$F_{Rk}$ [kN]	-	-	0,6	-
	$f_b \geq 50 \text{ N/mm}^2$	$F_{Rk}$ [kN]	0,9 (C)	-	1,5 (I)	-
Span. hollow brick Rojo hidrofugano Brick <b>D<sup>e)</sup></b>	$f_b \geq 6 \text{ N/mm}^2$	$F_{Rk}$ [kN]	0,60	-	-	-
Span. hollow brick Ladrillo perforado Brick <b>J<sup>e)</sup></b>	$f_b \geq 16 \text{ N/mm}^2$	$F_{Rk}$ [kN]	-	1,5	2,0	-
Span. hollow brick Clinker mediterraneo Brick <b>K<sup>e)</sup></b>	$f_b \geq 75 \text{ N/mm}^2$	$F_{Rk}$ [kN]	-	-	1,5	-
French hollow brick Brique Creuse <b>B<sup>e)</sup></b>	$f_b \geq 6 \text{ N/mm}^2$	$F_{Rk}$ [kN]	0,50	-	-	-
Autoclaved aerated concrete AAC	AAC 2	$F_{Rk}$ [kN]	-	-	0,9	0,9
	AAC 4	$F_{Rk}$ [kN]	-	-	2,0	2,5
	AAC 6	$F_{Rk}$ [kN]	-	-	2,0	2,5
			-	-	3,5 <sup>d)</sup>	4,5 <sup>d)</sup>

b) Values for hot-dipped galvanized carbon steel.

c) Values for stainless steel.

d) Valid for edge distance  $c \geq 150\text{mm}$ , intermediate values can be interpolated.

e) Specification on hollow base material brick types see separate table below.

f) Data can be determined by job-site testing, data for  $h_{nom}=50\text{mm}$  can be applied.

## Design resistance

Anchor size			HRD 8	HRD 10		
$h_{nom}$ [mm]			50	50	70	90
Concrete C12/15	$N_{Rd}$ [kN]		1,1	1,7	3,3	-
	$V_{Rd}$ [kN]		5,5 / 5,2 <sup>b)</sup>	8,5 / 8,1 <sup>b)</sup> / 8,5 <sup>c)</sup>		-
Concrete C16/20 – C 50/60	$N_{Rd}$ [kN]		1,7	2,5	4,7	-
	$V_{Rd}$ [kN]		5,5 / 5,2 <sup>b)</sup>	8,5 / 8,1 <sup>b)</sup> / 8,5 <sup>c)</sup>		-
Solid clay brick Mz 2,0 DIN V 105-100/EN 771-1	$f_b \geq 20$ N/mm <sup>2</sup>	$F_{Rd}$ [kN]	0,6	1,2 1,8 <sup>d)</sup>	f)	-
	$f_b \geq 10$ N/mm <sup>2</sup>	$F_{Rd}$ [kN]	0,48	0,8 1,2 <sup>d)</sup>	f)	-
Solid sand-lime brick KS 2,0 DIN V 106 /EN 771-2	$f_b \geq 20$ N/mm <sup>2</sup>	$F_{Rd}$ [kN]	1,0	1,2 1,8 <sup>d)</sup>	f)	-
	$f_b \geq 10$ N/mm <sup>2</sup>	$F_{Rd}$ [kN]	0,8	0,8 1,2 <sup>d)</sup>	f)	-
Lightweight solid block Vbl 0,9 DIN V 18151-100/EN 771	$f_b \geq 20$ N/mm <sup>2</sup>	$F_{Rd}$ [kN]	-	1,4 2,4 <sup>d)</sup>	f)	-
	$f_b \geq 10$ N/mm <sup>2</sup>	$F_{Rd}$ [kN]	-	1,0 1,8 <sup>d)</sup>	f)	-
	$f_b \geq 6$ N/mm <sup>2</sup>	$F_{Rd}$ [kN]	0,2	-	-	-
Ital. solid brick Tufo	$f_b \geq n/a$	$F_{Rd}$ [kN]	0,56	-	-	-
Hollow clay brick Hz B 12/1,2 Brick <b>A</b> <sup>e)</sup>	$f_b \geq 12$ N/mm <sup>2</sup>	$F_{Rd}$ [kN]	0,2	-	-	-
Vertic. perforated clay brick Hz 1,2-2DF Brick <b>F</b> <sup>e)</sup>	$f_b \geq 8$ N/mm <sup>2</sup>	$F_{Rd}$ [kN]	-	0,6	-	-
	$f_b \geq 10$ N/mm <sup>2</sup>	$F_{Rd}$ [kN]	-	0,8	-	-
	$f_b \geq 12$ N/mm <sup>2</sup>	$F_{Rd}$ [kN]	-	0,8	-	-
Vertic. perforated clay brick Hz 1,0-2DF Brick <b>G</b> <sup>e)</sup>	$f_b \geq 8$ N/mm <sup>2</sup>	$F_{Rd}$ [kN]	-	0,16	0,3	-
	$f_b \geq 10$ N/mm <sup>2</sup>	$F_{Rd}$ [kN]	-	0,2	0,36	-
	$f_b \geq 12$ N/mm <sup>2</sup>	$F_{Rd}$ [kN]	-	0,24	0,36	-
	$f_b \geq 20$ N/mm <sup>2</sup>	$F_{Rd}$ [kN]	-	0,36	0,6	-
Vertic. perforated clay brick Hz 1,0-2DF Brick <b>H</b> <sup>e)</sup>	$f_b \geq 28$ N/mm <sup>2</sup>	$F_{Rd}$ [kN]	-	0,8	1,0	-
	$f_b \geq 50$ N/mm <sup>2</sup>	$F_{Rd}$ [kN]	-	1,2	1,4	-
Vertic. perforated clay brick Poroton T8 Brick <b>M</b> <sup>e)</sup>	$f_b \geq 6$ N/mm <sup>2</sup>	$F_{Rd}$ [kN]	-	0,3	0,6	-
Vertic. perforated clay brick Hz 1,0-9DF Brick <b>L</b> <sup>e)</sup>	$f_b \geq 8$ N/mm <sup>2</sup>	$F_{Rd}$ [kN]	-	0,48	0,6	-
	$f_b \geq 10$ N/mm <sup>2</sup>	$F_{Rd}$ [kN]	-	0,6	0,6	-
	$f_b \geq 12$ N/mm <sup>2</sup>	$F_{Rd}$ [kN]	-	0,6	0,8	-
	$f_b \geq 16$ N/mm <sup>2</sup>	$F_{Rd}$ [kN]	-	0,8	1,2	-

b) Values for hot-dipped galvanized carbon steel.

c) Values for stainless steel.

d) Valid for edge distance  $c \geq 150$ mm, intermediate values can be interpolated.

e) Specification on hollow base material brick types see separate table below.

f) Data can be determined by job-site testing, data for  $h_{nom}=50$ mm can be applied.

## Design resistance

Anchor size			HRD 8		HRD 10	
			50	50	70	90
			$h_{nom}$ [mm]			
Hollow sand-lime brick KSL 12/1,4 Brick <b>O<sup>e)</sup></b>	$f_b \geq 12 \text{ N/mm}^2$	$F_{Rd}$ [kN]	0,3	-	-	-
	$f_b \geq 8 \text{ N/mm}^2$	$F_{Rd}$ [kN]	-	0,6	-	-
	$f_b \geq 10 \text{ N/mm}^2$	$F_{Rd}$ [kN]	-	0,6	-	-
Vertic. perforated clay brick Hz 1,6-2DF Brick <b>P<sup>e)</sup></b>	$f_b \geq 12 \text{ N/mm}^2$	$F_{Rd}$ [kN]	-	0,8	-	-
	$f_b \geq 8 \text{ N/mm}^2$	$F_{Rd}$ [kN]	-	-	0,8	-
	$f_b \geq 10 \text{ N/mm}^2$	$F_{Rd}$ [kN]	-	-	1,0	-
Vertic. perforated clay brick Hz 1,6-2DF Brick <b>Q<sup>e)</sup></b>	$f_b \geq 12 \text{ N/mm}^2$	$F_{Rd}$ [kN]	-	-	1,2	-
	$f_b \geq 8 \text{ N/mm}^2$	$F_{Rd}$ [kN]	-	0,36	0,48	-
	$f_b \geq 10 \text{ N/mm}^2$	$F_{Rd}$ [kN]	-	0,48	0,6	-
Vertic. perforated clay brick KSL R 1,6-16DF Brick <b>R<sup>e)</sup></b>	$f_b \geq 12 \text{ N/mm}^2$	$F_{Rd}$ [kN]	-	0,6	0,8	-
	$f_b \geq 16 \text{ N/mm}^2$	$F_{Rd}$ [kN]	-	0,8	1,0	-
	$f_b \geq 2 \text{ N/mm}^2$	$F_{Rd}$ [kN]	0,12	-	-	-
Lightweight hollow brick Hbl B 2/0,8 Brick <b>S<sup>e)</sup></b>	$f_b \geq 8 \text{ N/mm}^2$	$F_{Rd}$ [kN]	-	0,2	0,3	-
	$f_b \geq 10 \text{ N/mm}^2$	$F_{Rd}$ [kN]	-	0,48	0,8	-
Ital. hollow brick Poroton P700 Brick <b>N<sup>e)</sup></b>	$f_b \geq 20 \text{ N/mm}^2$	$F_{Rd}$ [kN]	0,6	-	-	-
Ital. hollow brick Doppio Uni Brick <b>C+I<sup>e)</sup></b>	$f_b \geq 28 \text{ N/mm}^2$	$F_{Rd}$ [kN]	-	-	0,24	-
	$f_b \geq 50 \text{ N/mm}^2$	$F_{Rd}$ [kN]	0,36 (C)	-	0,6 (I)	-
Span. hollow brick Rojo hidrofugano Brick <b>D<sup>e)</sup></b>	$f_b \geq 6 \text{ N/mm}^2$	$F_{Rd}$ [kN]	0,24	-	-	-
Span. hollow brick Ladrillo perforado Brick <b>J<sup>e)</sup></b>	$f_b \geq 16 \text{ N/mm}^2$	$F_{Rd}$ [kN]	-	0,6	0,8	-
Span. hollow brick Clinker mediterraneo Brick <b>K<sup>e)</sup></b>	$f_b \geq 75 \text{ N/mm}^2$	$F_{Rd}$ [kN]	-	-	0,6	-
French hollow brick Brique Creuse <b>B<sup>e)</sup></b>	$f_b \geq 6 \text{ N/mm}^2$	$F_{Rd}$ [kN]	0,20	-	-	-
Autoclaved aerated concrete AAC	AAC 2	$F_{Rd}$ [kN]	-	-	0,45	0,45
	AAC 4	$F_{Rd}$ [kN]	0,21	-	1,0	1,25
	AAC 6	$F_{Rd}$ [kN]	0,21	-	1,0	1,25
			0,21	-	1,75 <sup>d)</sup>	2,25 <sup>d)</sup>

b) Values for hot-dipped galvanized carbon steel.

c) Values for stainless steel.

d) Valid for edge distance  $c \geq 150\text{mm}$ , intermediate values can be interpolated.

e) Specification on hollow base material brick types see separate table below.

f) Data can be determined by job-site testing, data for  $h_{nom}=50\text{mm}$  can be applied.

**Recommended loads a)**

Anchor size			HRD 8	HRD 10		
$h_{nom}$ [mm]			50	50	70	90
Concrete C12/15	$N_{Rec}$ [kN]		0,8	1,2	2,4	-
	$V_{Rec}$ [kN]		3,9 / 3,7 <sup>b)</sup>	6,1 / 5,8 <sup>b)</sup> / 6,1 <sup>c)</sup>		-
Concrete C16/20 – C 50/60	$N_{Rec}$ [kN]		1,2	1,8	3,4	-
	$V_{Rec}$ [kN]		3,9 / 3,7 <sup>b)</sup>	6,1 / 5,8 <sup>b)</sup> / 6,1 <sup>c)</sup>		-
Solid clay brick Mz 2,0 DIN V 105-100/EN 771-1	$f_b \geq 20$ N/mm <sup>2</sup>	$F_{Rec}$ [kN]	0,42	0,85 1,28 <sup>d)</sup>	f)	-
	$f_b \geq 10$ N/mm <sup>2</sup>	$F_{Rec}$ [kN]	0,34	0,57 0,85 <sup>d)</sup>	f)	-
Solid sand-lime brick KS 2,0 DIN V 106 /EN 771-2	$f_b \geq 20$ N/mm <sup>2</sup>	$F_{Rec}$ [kN]	0,7	0,85 1,28 <sup>d)</sup>	f)	-
	$f_b \geq 10$ N/mm <sup>2</sup>	$F_{Rec}$ [kN]	0,57	0,57 0,85 <sup>d)</sup>	f)	-
Lightweight solid block Vbl 0,9 DIN V 18151-100/EN 771	$f_b \geq 20$ N/mm <sup>2</sup>	$F_{Rec}$ [kN]	-	1,0 1,71 <sup>d)</sup>	f)	-
	$f_b \geq 10$ N/mm <sup>2</sup>	$F_{Rec}$ [kN]	-	0,71 1,28 <sup>d)</sup>	f)	-
	$f_b \geq 6$ N/mm <sup>2</sup>	$F_{Rec}$ [kN]	0,14	-	-	-
Ital. solid brick Tufo	$f_b \geq n/a$	$F_{Rd}$ [kN]	0,4	-	-	-
Hollow clay brick Hz B 12/1,2 Brick <b>A</b> <sup>e)</sup>	$f_b \geq 12$ N/mm <sup>2</sup>	$F_{Rd}$ [kN]	0,14	-	-	-
Vertic. perforated clay brick Hz 1,2-2DF Brick <b>F</b> <sup>e)</sup>	$f_b \geq 8$ N/mm <sup>2</sup>	$F_{Rd}$ [kN]	-	0,42	-	-
	$f_b \geq 10$ N/mm <sup>2</sup>	$F_{Rd}$ [kN]	-	0,57	-	-
	$f_b \geq 12$ N/mm <sup>2</sup>	$F_{Rd}$ [kN]	-	0,57	-	-
Vertic. perforated clay brick Hz 1,0-2DF Brick <b>G</b> <sup>e)</sup>	$f_b \geq 8$ N/mm <sup>2</sup>	$F_{Rd}$ [kN]	-	0,11	0,21	-
	$f_b \geq 10$ N/mm <sup>2</sup>	$F_{Rd}$ [kN]	-	0,14	0,25	-
	$f_b \geq 12$ N/mm <sup>2</sup>	$F_{Rd}$ [kN]	-	0,17	0,25	-
	$f_b \geq 20$ N/mm <sup>2</sup>	$F_{Rd}$ [kN]	-	0,25	0,42	-
Vertic. perforated clay brick Hz 1,0-2DF Brick <b>H</b> <sup>e)</sup>	$f_b \geq 28$ N/mm <sup>2</sup>	$F_{Rd}$ [kN]	-	0,57	0,71	-
	$f_b \geq 50$ N/mm <sup>2</sup>	$F_{Rd}$ [kN]	-	0,85	1,0	-
Vertic. perforated clay brick Poroton T8 Brick <b>M</b> <sup>e)</sup>	$f_b \geq 6$ N/mm <sup>2</sup>	$F_{Rd}$ [kN]	-	0,21	0,42	-
Vertic. perforated clay brick Hz 1,0-9DF Brick <b>L</b> <sup>e)</sup>	$f_b \geq 8$ N/mm <sup>2</sup>	$F_{Rd}$ [kN]	-	0,34	0,42	-
	$f_b \geq 10$ N/mm <sup>2</sup>	$F_{Rd}$ [kN]	-	0,42	0,42	-
	$f_b \geq 12$ N/mm <sup>2</sup>	$F_{Rd}$ [kN]	-	0,42	0,57	-
	$f_b \geq 16$ N/mm <sup>2</sup>	$F_{Rd}$ [kN]	-	0,57	0,85	-

- a) With overall partial safety factor for action  $\gamma = 1,4$ . The partial safety factors for action depend on the type of loading and shall b-e taken from national regulations.
- b) Values for hot-dipped galvanized carbon steel.
- c) Values for stainless steel.
- d) Valid for edge distance  $c \geq 150$ mm, intermediate values can be interpolated.
- e) Specification on hollow base material brick types see separate table below.
- f) Data can be determined by job-site testing, data for  $h_{nom}=50$ mm can be applied.

**Recommended loads <sup>a)</sup>**

Anchor size			HRD 8	HRD 10		
			50	50	70	90
		$h_{nom}$ [mm]				
Hollow sand-lime brick KSL 12/1,4 Brick <b>O<sup>e)</sup></b>	$f_b \geq 12 \text{ N/mm}^2$	$F_{Rec}$ [kN]	0,21	-	-	-
Vertic. perforated clay brick Hlz 1,6-2DF Brick <b>P<sup>e)</sup></b>	$f_b \geq 8 \text{ N/mm}^2$	$F_{Rec}$ [kN]	-	0,42	-	-
	$f_b \geq 10 \text{ N/mm}^2$	$F_{Rec}$ [kN]	-	0,42	-	-
	$f_b \geq 12 \text{ N/mm}^2$	$F_{Rec}$ [kN]	-	0,57	-	-
Vertic. perforated clay brick Hlz 1,6-2DF Brick <b>Q<sup>e)</sup></b>	$f_b \geq 8 \text{ N/mm}^2$	$F_{Rec}$ [kN]	-	-	0,57	-
	$f_b \geq 10 \text{ N/mm}^2$	$F_{Rec}$ [kN]	-	-	0,71	-
	$f_b \geq 12 \text{ N/mm}^2$	$F_{Rec}$ [kN]	-	-	0,85	-
Vertic. perforated clay brick KSL R 1,6-16DF Brick <b>R<sup>e)</sup></b>	$f_b \geq 8 \text{ N/mm}^2$	$F_{Rec}$ [kN]	-	0,25	0,34	-
	$f_b \geq 10 \text{ N/mm}^2$	$F_{Rec}$ [kN]	-	0,34	0,42	-
	$f_b \geq 12 \text{ N/mm}^2$	$F_{Rec}$ [kN]	-	0,42	0,57	-
	$f_b \geq 16 \text{ N/mm}^2$	$F_{Rec}$ [kN]	-	0,57	0,71	-
Lightweight hollow brick Hbl B 2/0,8 Brick <b>S<sup>e)</sup></b>	$f_b \geq 2 \text{ N/mm}^2$	$F_{Rec}$ [kN]	0,09	-	-	-
Lightweight concrete hollow block Hbl 1,2-12DF Brick <b>T<sup>e)</sup></b>	$f_b \geq 8 \text{ N/mm}^2$	$F_{Rec}$ [kN]	-	0,14	0,21	-
	$f_b \geq 10 \text{ N/mm}^2$	$F_{Rec}$ [kN]	-	0,34	0,57	-
Ital. hollow brick Poroton P700 Brick <b>N<sup>e)</sup></b>	$f_b \geq 20 \text{ N/mm}^2$	$F_{Rec}$ [kN]	0,43	-	-	-
Ital. hollow brick Doppio Uni Brick <b>C+I<sup>e)</sup></b>	$f_b \geq 28 \text{ N/mm}^2$	$F_{Rec}$ [kN]	-	-	0,17	-
	$f_b \geq 50 \text{ N/mm}^2$	$F_{Rec}$ [kN]	0,25 (C)	-	0,42 (I)	-
Span. hollow brick Rojo hidrofugano Brick <b>D<sup>e)</sup></b>	$f_b \geq 6 \text{ N/mm}^2$	$F_{Rec}$ [kN]	0,17	-	-	-
Span. hollow brick Ladrillo perforado Brick <b>J<sup>e)</sup></b>	$f_b \geq 16 \text{ N/mm}^2$	$F_{Rec}$ [kN]	-	0,42	0,57	-
Span. hollow brick Clinker mediterraneo Brick <b>K<sup>e)</sup></b>	$f_b \geq 75 \text{ N/mm}^2$	$F_{Rec}$ [kN]	-	-	0,42	-
French hollow brick Brique Creuse <b>B<sup>e)</sup></b>	$f_b \geq 6 \text{ N/mm}^2$	$F_{Rec}$ [kN]	0,14	-	-	-
Autoclaved aerated concrete AAC	AAC 2	$F_{Rec}$ [kN]	-	-	0,32	0,32
	AAC 4	$F_{Rec}$ [kN]	0,15	-	0,71	0,89
	AAC 6	$F_{Rec}$ [kN]	0,15	-	0,71	0,89
			0,15	-	1,25 <sup>d)</sup>	1,6 <sup>d)</sup>

a) With overall partial safety factor for action  $\gamma = 1,4$ . The partial safety factors for action depend on the type of loading and shall be taken from national regulations.

b) Values for stainless steel.

c) Valid for edge distance  $c \geq 150\text{mm}$ , intermediate values can be interpolated.

d) Specification on hollow base material brick types see separate table below.

e) Data can be determined by job-site testing, data for  $h_{nom}=50\text{mm}$  can be applied.

**Characteristic resistance for pull-out failure (plastic sleeve) for use in concrete**

Anchor size		HRD 8	HRD 10	
<b>In standard concrete slabs</b>				
Embedment depth	$h_{nom} \geq$ [mm]	50	50	70
Characteristic resistance	$\geq C16/20$ $N_{Rk,p}$ [kN]	3,0	4,5	8,5
	C12/15 $N_{Rk,p}$ [kN]	2,0	3,0	6,0
Partial safety factor	$\gamma_{Mc}^{a)}$	1,8		
<b>In thin skins (whether resistant skins of external wall panels)</b>				
Embedment depth	$h_{nom} \geq$ [mm]	-	50	-
Characteristic resistance	$h=100\text{mm}$ $\geq C16/20$ $N_{Rk,p}$ [kN]	-	3,5	-
	$\text{to } 400\text{mm}$ C12/15 $N_{Rk,p}$ [kN]	-	2,5	-
Partial safety factor	$\gamma_{Mc}^{a)}$	1,8		
<b>In precast prestressed hollow cored slabs</b>				
Embedment depth	$h_{nom} \geq$ [mm]	-	50	
Characteristic resistance	$d_b \geq 25\text{mm}$ $\geq C16/20$ $N_{Rk,p}$ [kN]	-	0,6	
	$d_b \geq 30\text{mm}$ $\geq C16/20$ $N_{Rk,p}$ [kN]	-	1,5	
	$d_b \geq 35\text{mm}$ $\geq C16/20$ $N_{Rk,p}$ [kN]	-	2,5	
	$d_b \geq 40\text{mm}$ $\geq C16/20$ $N_{Rk,p}$ [kN]		3,5	
Partial safety factor	$\gamma_{Mc}^{a)}$	1,8		

a) In absence of other regulations.



**Specification of hollow base material brick types**

Specification	Picture	Drilling method	Specification	Picture	Drilling method
Brick <b>A</b> Hlz B 12/1,2 LxWxH [mm]: 300x240x248 h <sub>min</sub> [mm]: 240		Rotary drilling	Brick <b>B</b> Brique Creuse LxWxH [mm] : 210x198x... h <sub>min</sub> [mm]: 210		Rotary drilling
Brick <b>C</b> Doppio Uni LxWxH [mm]: 230x120x100 h <sub>min</sub> [mm]: 120		Rotary drilling	Brick <b>D</b> Rojo hidrofugano LxWxH [mm]: 240x115x50 h <sub>min</sub> [mm]: 115		Rotary drilling
brick <b>E</b> Mattone LxWxH [mm]: 240x180x100 h <sub>min</sub> [mm]: 180		Rotary drilling	brick <b>F</b> Hlz 1,2-2DF LxWxH [mm]: 240x115x113 h <sub>min</sub> [mm]: 115		Hammer drilling
brick <b>G</b> Hlz 1,0-2DF LxWxH [mm]: 240x115x113 h <sub>min</sub> [mm]: 110		Hammer drilling	brick <b>H</b> VHlz 1,6-2DF LxWxH [mm]: 240x115x113 h <sub>min</sub> [mm]: 115		Hammer drilling
brick <b>I</b> Doppio Uni LxWxH [mm]: 250x120x190 h <sub>min</sub> [mm]: 120		Rotary drilling	brick <b>J</b> Ladrillo perforado LxWxH [mm]: 240x110x100 h <sub>min</sub> [mm]: 110		Rotary drilling
brick <b>K</b> Clinker mediterr. LxWxH [mm]: 240x113x50 h <sub>min</sub> [mm]: 113		Hammer drilling	brick <b>L</b> Hlz 1,0-9DF LxWxH [mm]: 372x175x238 h <sub>min</sub> [mm]: 175		Rotary drilling
brick <b>M</b> Poroton T8 LxWxH [mm]: 248x365x249 h <sub>min</sub> [mm]: 365		Rotary drilling	brick <b>N</b> Poroton P700 LxWxH [mm]: 225x300x190 h <sub>min</sub> [mm]: 300		Rotary drilling
<b>Hollow sand-lime bricks according EN 771-2</b>					
brick <b>O</b> KSL 12/1,4 LxWxH [mm]: 240x248x248 h <sub>min</sub> [mm]: 240		Hammer drilling	brick <b>P</b> KS L 1,6-2DF LxWxH [mm]: 240x115x113 h <sub>min</sub> [mm]: 115		Hammer drilling
brick <b>Q</b> KS L 1,4-3DF LxWxH [mm]: 240x175x113 h <sub>min</sub> [mm]: 175		Hammer drilling	brick <b>R</b> KS L R 1,6-16DF LxWxH [mm]: 480x240x248 h <sub>min</sub> [mm]: 240		Rotary drilling
brick <b>S</b> Hbl 2/0,8 LxWxH [mm]: 497x240x248 h <sub>min</sub> [mm]: 240		Hammer drilling	brick <b>T</b> Hbl 1,2-12DF LxWxH [mm]: 497x175x238 h <sub>min</sub> [mm]: 175		Rotary drilling

### Requirements for redundant fastening

The definition of redundant fastening according to Member States is given in ETAG 020. In Absence of a definition by a Member State the following default values may be taken

Maximum number of fixing points	Minimum number of anchors per fixing point	Maximum design load of action $N_{sd}$ per fixing point <sup>a)</sup>
3	1	3 [kN]
4	1	4,5 [kN]

### Materials

#### Mechanical properties

Anchor size		HRD 8		HRD 10		
		Galvanized steel	Stainless steel	Galvanized steel	Hot-deep galvanized	Stainless steel
Nominal tensile strength $f_{uk}$	[N/mm <sup>2</sup> ]	600	580	600	600	630
Yield strength $f_{yk}$	[N/mm <sup>2</sup> ]	480	450	480	480	480
Stressed cross-section $A_s$	[mm <sup>2</sup> ]	22,9	22,9	35,3	33,7	35,3
Moment of resistance $W$	[mm <sup>3</sup> ]	15,5	15,5	29,5	27,6	29,5
Char. bending resistance $M^0_{Rk,s}$	[Nm]	11,1	10,8	21,3	19,9	22,3

#### Material quality

Part	Material	
Sleeve	Polyamide, colour red	
Screw <sup>a)</sup>	HRD-C, -H, -K, -P HDS-C, -H, -K, -P	Carbon steel, galvanized to min.5 $\mu$ m
	HRD-HF; HDS-HF	Carbon steel, hot-dip galvanized to min. 65 $\mu$ m
	HRD-CR2, -HR2, -KR2, -PR2 HDS-CR2, -HR2, -KR2, -PR2	Stainless steel, corrosion class II: 1.4301 / 1.4567
	HRD-CR, -HR, -KR, -PR HDS-CR, -HR, -KR, -PR	Stainless steel, corrosion class III: 1.4362/1.4401/1.4404/1.4571

a) Marking of the screw (HDR and HDS) depending on the supply.

#### Anchor dimension

Anchor size		HRD 8	HRD 10
Minimum thickness of fixture	$t_{fix,min}$ [mm]	0	0
Maximum thickness of fixture	$t_{fix,max}$ [mm]	90	260
Diameter of the sleeve	$d_{nom}$ [mm]	8	10
Minimum length of the sleeve	$l_{1,min}$ [mm]	60	60
Maximum length of the sleeve	$l_{1,max}$ [mm]	140	310
Diameter of plastic washer	$d_{pw}$ [mm]	-	17,5
Thickness of plastic washer	$t_{pw}$ [mm]	-	2
Diameter of the screw	$d_s$ [mm]	6	7
Minimum length of the screw	$l_{2,min}$ [mm]	65	65
Maximum length of the screw	$l_{2,max}$ [mm]	145	315
Head diameter of countersunk screw	$d_{sc}$ [mm]	11	14
Head diameter of hexhead screw	$d_{sw}$ [mm]	-	17,5

### Anchor sleeve

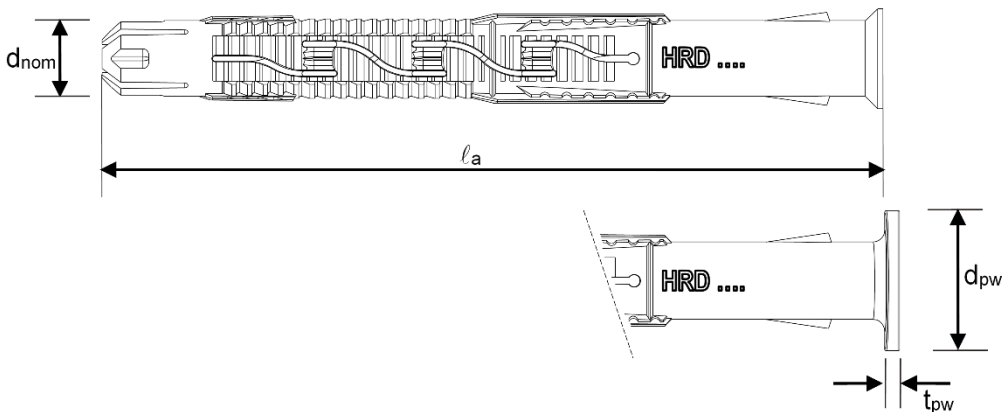

### Special screw

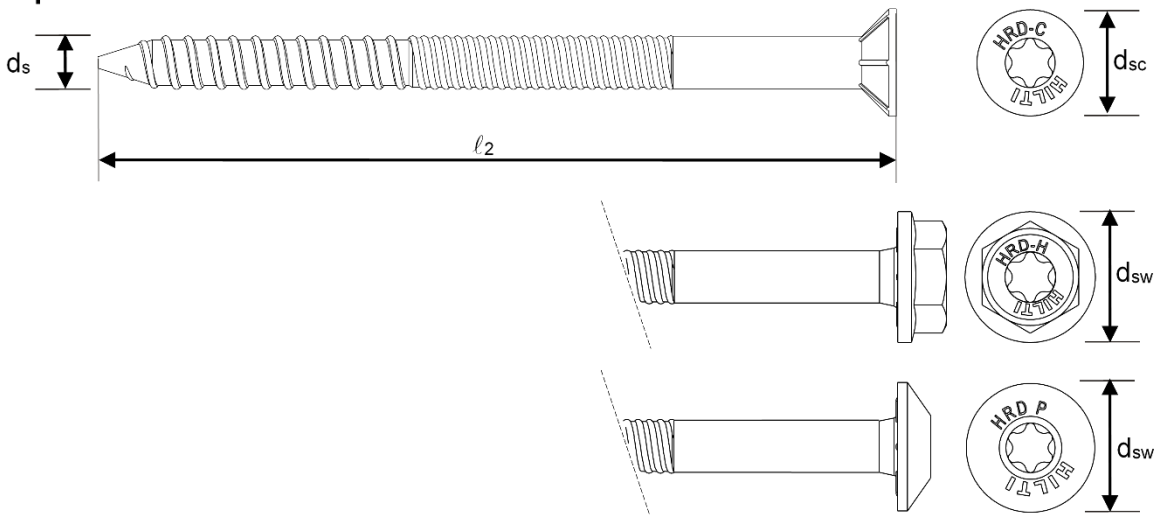

### Setting information

#### Installation temperature

-10°C to +40°C

#### Service temperature range

Hilti HRD frame anchors may be applied in the temperature range given below.

Temperature range	Base material temperature	Max. long term base material temperature	Max. short term base material temperature
Temperature range	-40 °C to +80 °C	+50 °C	+80 °C

#### Max short term base material temperature

Short-term elevated base material temperatures are those that occur over brief intervals, e.g. as a result of diurnal cycling.

#### Max long term base material temperature

Long-term elevated base material temperatures are roughly constant over significant periods of time.

### Setting details

Anchor size			HRD 8	HRD 10
Drill hole diameter	$d_o$	[mm]	8	10
Cutting diameter of drill bit	$d_{cut} \leq$	[mm]	8,45	10,45
Depth of drilled hole to deepest point	$h_{1,1} \geq$	[mm]	60	60
	$h_{1,2} \geq$	[mm]	-	80
	$h_{1,3} \geq$	[mm]	-	100 <sup>a)</sup>
Overall plastic anchor embedment depth in base material	$h_{nom,1} \geq$	[mm]	50	50
	$h_{nom,2} \geq$	[mm]	-	70
	$h_{nom,3} \geq$	[mm]	-	90 <sup>a)</sup>
Diameter of clearance hole in the fixture	Countersunk screw	$d_f \leq$	[mm]	8,5
	Hexhead screw	$d_f \leq$	[mm]	-
				11
				12

a) For use in AAC

### Setting parameters

Anchor size			HRD 8	HRD 10		
	$h_{nom}$	[mm]	50	50	70	
Minimum base material thickness	Concrete	$h_{min}$	[mm]	100	100	120
	Concrete thin skin	$h_{min}$	[mm]	-	40	-
	Masonry <sup>e)</sup>	$h_{min}$	[mm]	115-300		
Minimum spacing	Concrete $\geq$ C16/20	$s_{min}$	[mm]	100	50	
		for $c \geq$	[mm]	50	100 <sup>c)</sup>	
	Concrete C12/15	$s_{min}$	[mm]	140	70	
		for $c \geq$	[mm]	70	140 <sup>c)</sup>	
	Masonry and AAC	$a_{min}$	[mm]	250	250	
		$s_{min1}$	[mm]	200 (120 <sup>d)</sup> )	100	
$s_{min2}$		[mm]	400 (240 <sup>d)</sup> )	100		
Minimum edge distance	Concrete $\geq$ C16/20	$c_{min}$	[mm]	50	50	
		for $s \geq$	[mm]	100	150 <sup>c)</sup>	
	Concrete C12/15	$c_{min}$	[mm]	70	70	
		for $s \geq$	[mm]	140	210 <sup>c)</sup>	
Masonry and AAC	$c_{min}$	[mm]	100 (60 <sup>d)</sup> )	100		
Critical spacing in concrete <sup>a)</sup>	Concrete $\geq$ C16/20	$s_{cr,N}$	[mm]	62	80	125
	Concrete C12/15	$s_{cr,N}$	[mm]	68	90	135
Critical edge distance in concrete <sup>b)</sup>	Concrete $\geq$ C16/20	$c_{cr,N}$	[mm]	100	100	
	Concrete C12/15	$c_{cr,N}$	[mm]	140	140	

a) For spacing larger than the critical spacing each anchor in a group can be considered in design

b) For edge distance smaller than critical edge distance the design loads

c) Linear interpolation allowed

d) Only for brick "Doppio Uni" and "Mattone"

e) Minimum base material thickness of masonry depends on brick type; see specification of brick types in the table above

For spacing (edge distance) smaller than critical spacing (critical edge distance) the design loads have to be reduced.

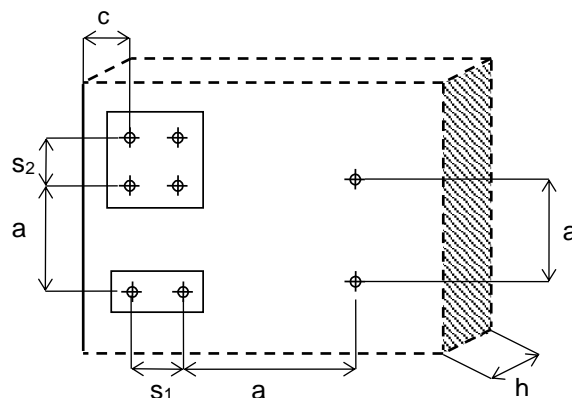

### Installation equipment

Anchor size	HRD 8	HRD 10
Rotary hammer	TE 2- TE16	
Other tools	Hammer, Screwdriver	

### Admissible anchor positions, min. spacing and edge distance of anchors and distance between anchor groups in precast pre-stressed hollow core slabs

Anchor size		HRD 8	HRD 10
Overall plastic anchor embedment depth in the base material	$h_{nom} \geq$ [mm]	-	50
Bottom flange thickness	$d_b \geq$ [mm]	-	25
Core distance	$l_c \geq$ [mm]	-	100
Prestressing steel distance	$l_p \geq$ [mm]	-	100
Distance between anchor position and prestressing steel	$a_p \geq$ [mm]	-	50
Minimum edge distance	$c_{min} \geq$ [mm]	-	100
Minimum anchor spacing	$s_{min} \geq$ [mm]	-	100
Minimum distance between anchor groups	$a_{min} \geq$ [mm]	-	100

### Schemes of distances and spacing

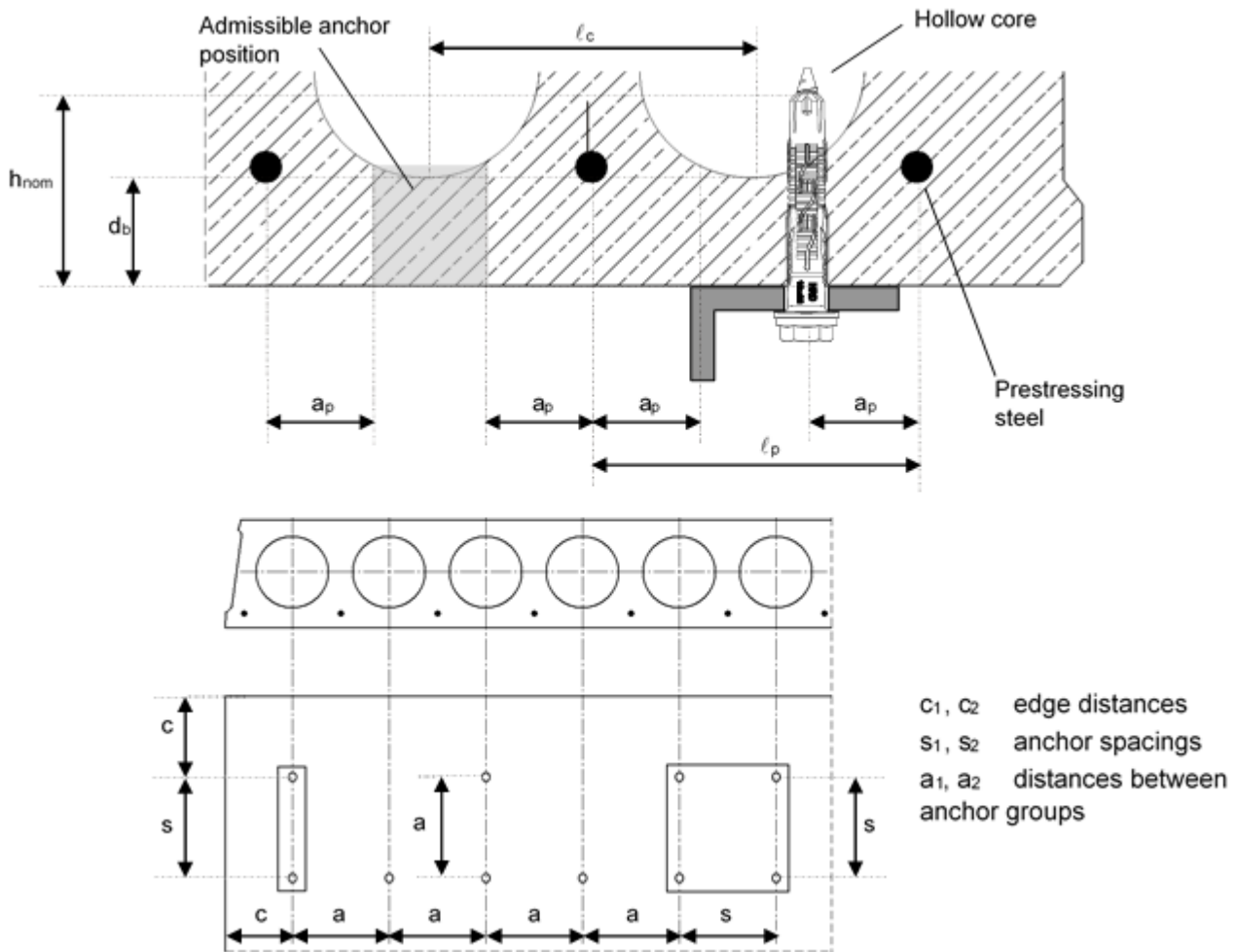

Setting instruction





\*For detailed information on installation see instruction for use given with the package of the product.

Setting instruction for HRD	
<p><b>1. Drilling</b></p>	<p><b>2. Inserting the anchor</b></p>
<p><b>3. Inserting the anchor</b></p>	<p><b>4. Setting tools</b></p>
<p><b>5. Checking</b></p>	<p><b>6. Attaching the belonging washer</b></p>
<p><b>7. Attaching the belonging washer</b></p>	
Additional preparation in case of application in precast prestressed hollow core slabs	
<p><b>1. Location of pre-stressed bars</b></p>	<p><b>2. Marking location of pre-stressed bars</b></p>
<p><b>3. Marking location of pre-stressed bars</b></p>	<p><b>4. Drilling</b></p>



# HRD Plastic frame anchors

Everyday standard plastic frame anchor for single use applications

Anchor version	Benefits
 HRD-C HRD-CR HRD-CR2 (M10)	<ul style="list-style-type: none"> <li>- Innovative screw design for better hold</li> <li>- Suitable on practically all base materials</li> <li>- Flexible embedment depth (approved at 50mm and 70mm)</li> <li>- Suitable for fastening thicknesses up to 260mm</li> <li>- Available in 4 different materials for optimum suitability in all corrosive environments</li> <li>- Pre-assembled for optimum handling and fastening quality</li> </ul>
 HRD-H HRD-HR HRD-HR2 HR-HF (M10)	
 HRD-K HRD-KR HRD-KR2 (M10)	
 HRD-P HRD-PR HRD-PR2 (M10)	

## Base material



Concrete

Approvals / certificates		
Description	Authority / Laboratory	No./ date of issue
Allgemeine bauaufsichtliche Zulassung <sup>a)</sup> (German approval)	DIBt, Berlin	Z-21.2-2034 / 2014-11-14

c) All data given in this section according Z-21.2-2034, issue 2014-11-14.

## Basic loading data

- All data in this section applies to:**
- Correct setting (See setting instruction)
  - No edge distance and spacing influence
  - Base material as specified in the table
  - Minimum base material thickness
  - Shear without lever arm
  - Use at max. temperature of +30°C(long term) or +50°C (short term)



### Characteristic resistance

Anchor type		HRD 10		
Anchor screw material		Galvanized steel	Hot-dip galvanized steel	Stainless steel
<b>Non-cracked concrete</b>				
Tension $N_{Rk}$	[kN]	15,2	15,2	15,2
Shear $V_{Rk}$	[kN]	10,6	10,1	11,1
<b>Cracked concrete</b>				
Tension $N_{Rk}$	[kN]	4,4	4,4	4,4
Shear $V_{Rk}$	[kN]	9,0	9,0	9,0

### Design resistance

Anchor type		HRD 10		
Anchor screw material		Galvanized steel	Hot-dip galvanized steel	Stainless steel
<b>Non-cracked concrete</b>				
Tension $N_{Rd}$	[kN]	6,0	6,0	6,0
Shear $V_{Rd}$	[kN]	8,5	8,1	8,5
<b>Cracked concrete</b>				
Tension $N_{Rd}$	[kN]	1,7	1,7	1,7
Shear $V_{Rd}$	[kN]	5,0	5,0	5,0

### Recommended loads <sup>a)</sup>

Anchor type		HRD 10		
Anchor screw material		Galvanized steel	Hot-dip galvanized steel	Stainless steel
<b>Non-cracked concrete</b>				
Tension $N_{Rec}$	[kN]	4,3	4,3	4,3
Shear $V_{Rec}$	[kN]	6,1	5,8	6,1
<b>Cracked concrete</b>				
Tension $N_{Rec}$	[kN]	1,2	1,2	1,2
Shear $V_{Rec}$	[kN]	3,6	3,6	3,6

a) With overall partial safety factor for action  $\gamma = 1,4$ . The partial safety factors for action depend on the type of loading and shall be taken from national regulations.

### Materials

#### Mechanical properties

Anchor type		HRD 10		
Anchor screw material		Galvanized steel	Hot-dip galvanized steel	Stainless steel
Nominal tensile strength $f_{uk}$	[N/mm <sup>2</sup> ]	600	600	630
Yield strength $f_{yk}$	[N/mm <sup>2</sup> ]	480	480	480
Stressed cross-section $A_s$	[mm <sup>2</sup> ]	35,3	33,7	35,3
Moment of resistance $W$	[mm <sup>3</sup> ]	29,5	27,6	29,5
Char. bending resistance $M^0_{Rk,s}$	[Nm]	21,3	19,9	22,3

#### Material quality

Part	Material
Sleeve	Polyamide, colour red
Screw	HRD-C, -H, -K, -P
	HRD-HF
	HRD-CR2, -HR2, -KR2, -PR2
	HRD-CR, -HR, -KR, -PR

### Anchor dimension

Anchor size			HRD 10
Minimum thickness of fixture	$t_{fix,min}$	[mm]	0
Maximum thickness of fixture	$t_{fix,max}$	[mm]	260
Diameter of the sleeve	$d_{nom}$	[mm]	10
Minimum length of the sleeve	$l_{1,min}$	[mm]	60
Maximum length of the sleeve	$l_{1,max}$	[mm]	310
Diameter of plastic washer	$d_{pw}$	[mm]	17,5
Thickness of plastic washer	$t_{pw}$	[mm]	2
Diameter of the screw	$d_s$	[mm]	7
Minimum length of the screw	$l_{2,min}$	[mm]	65
Maximum length of the screw	$l_{2,max}$	[mm]	315
Head diameter of countersunk screw	$d_{sc}$	[mm]	14
Head diameter of hexhead screw	$d_{sw}$	[mm]	17,5
Length of threaded section	$L_t$	[mm]	70

#### Anchor sleeve

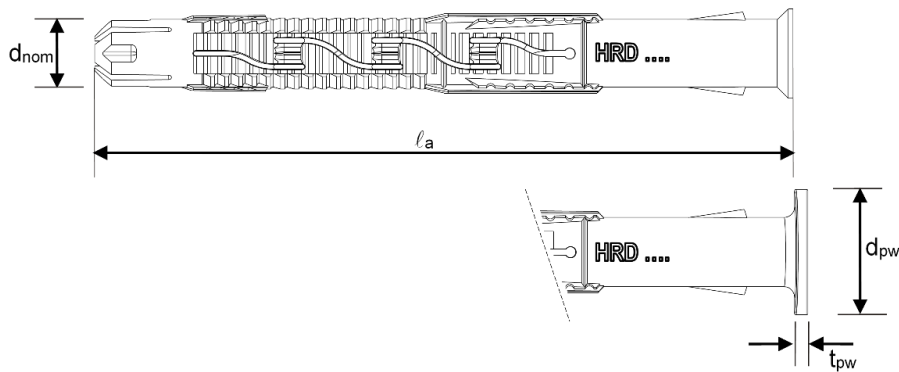

#### Special screw

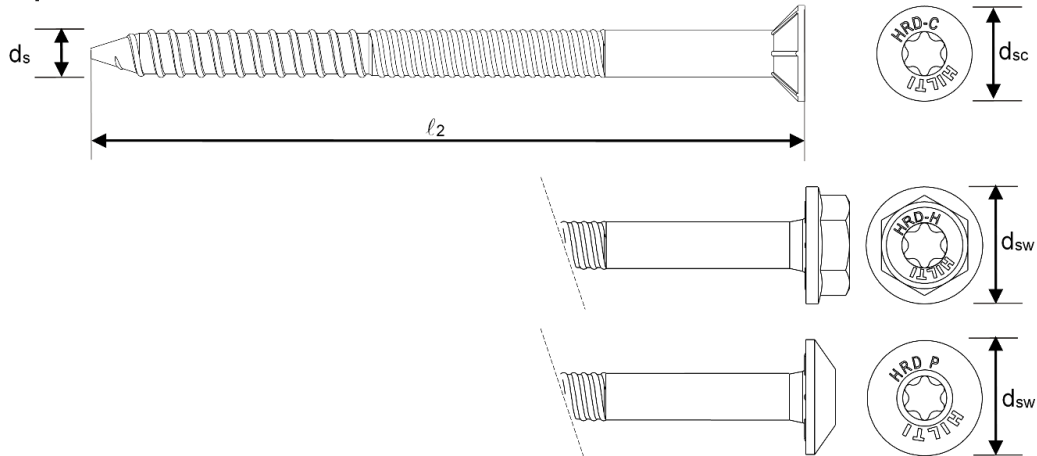

## Setting information

### Installation temperature

-10°C to +40°C

### Service temperature range

Hilti HRD frame anchors may be applied in the temperature range given below.

Temperature range	Base material temperature	Max. long term base material temperature	Max. short term base material temperature
Temperature range I	-40 °C to +50 °C	+30 °C	+50 °C
Temperature range II	-40 °C to +80 °C	+50 °C	+80 °C

### Max short term base material temperature

Short-term elevated base material temperatures are those that occur over brief intervals, e.g. as a result of diurnal cycling.

### Max long term base material temperature

Long-term elevated base material temperatures are roughly constant over significant periods of time.

## Setting details

Anchor size			HRD 10
Drill hole diameter	$d_o$	[mm]	10
Cutting diameter of drill bit	$d_{cut} \leq$	[mm]	10,45
Depth of drilled hole to deepest point	$h_1 \geq$	[mm]	80
Overall plastic anchor embedment depth in base material	$h_{nom} \geq$	[mm]	70
Diameter of clearance hole in the fixture	Countersunk screw	$d_f \leq$	11
	Hexhead screw	$d_f \leq$	12

## Setting parameters

Anchor size			HRD 10	
		$h_{nom}$	70	
Minimum base material thickness	Concrete	$h_{min}$	120	
Minimum spacing <sup>a)</sup>	Concrete $\geq$ C20/25	$s_{min}$	50	
		for $c \geq$	100	
Minimum edge distance <sup>a)</sup>	Concrete $\geq$ C20/25	$c_{min}$	50	
		for $s \geq$	150	
Critical spacing for splitting failure	Concrete $\geq$ C20/25	$s_{cr,sp}$	300	
Critical edge distance for splitting failure	Concrete $\geq$ C20/25	$c_{cr,sp}$	150	
<b>Concrete</b>			<b>Non-cracked</b>	<b>Cracked</b>
Critical spacing for concrete cone failure	Concrete $\geq$ C20/25	$s_{cr,N}$	135	75
Critical edge distance for concrete cone failure	Concrete $\geq$ C20/25	$c_{cr,N}$	38	68

a) Linear interpolation allowed

For spacing (edge distance) smaller than critical spacing (critical edge distance) the design loads have to be reduced.

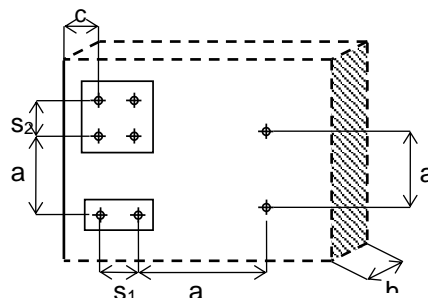

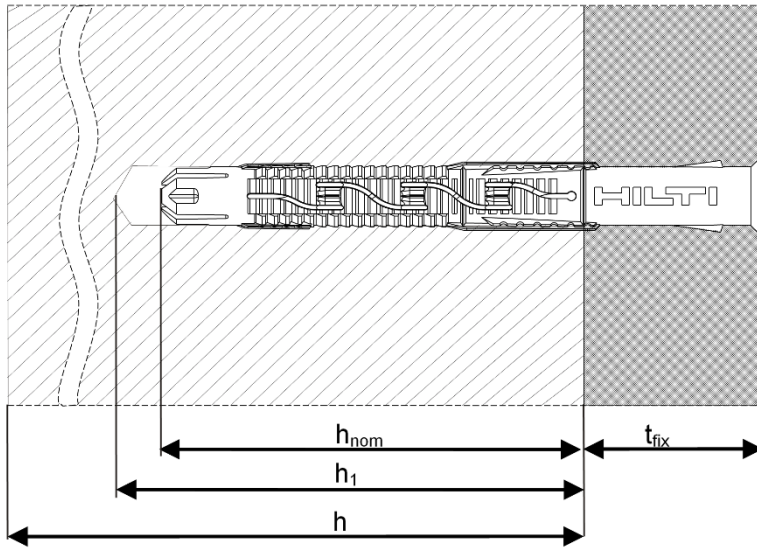

### Installation equipment

Anchor size	HRD 10
Rotary hammer	TE 2 (-A) - TE16 (-A)
Other tools	Hammer, Screwdriver

### Setting instruction

\*For detailed information on installation see instruction for use given with the package of the product.

Setting instruction for HRD	
<p><b>1. Drilling</b></p>	<p><b>2. Cleaning</b></p>
<p><b>3. Inserting the anchor</b></p>	<p><b>4. Inserting the anchor</b></p>
<p><b>5. Setting tools</b></p>	<p><b>6. Checking</b></p>



Chemical anchors

Mechanical anchors

**Plastic/Light duty metal anchors**

Insulation anchors

# HRV Plastic anchors

## Economical plastic frame anchor

### Anchor version



HRV-H  
HRV-HF  
(M10)

### Benefits

- Available in carbon steel and hot-deep galvanized
- Suitable for concrete and steel washers
- Integrated plastic and steel washer

### Base material



Concrete  
(non-cracked)

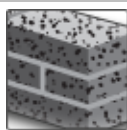

Solid brick

### Basic loading data

#### All data in this section applies to:

- Correct setting (See setting instruction)
- No edge distance and spacing influence
- Non-cracked concrete C16/20 – C50/60, other base material as specified
- Minimum base material thickness
- *Steel failure*
- Shear without lever arm
- Anchor for single point application

### Characteristic resistance

Anchor size		HRV 10		
		$h_{nom}$	[mm]	70
Concrete C16/20 – C50/60		$N_{Rk}$	[kN]	6,0
		$V_{Rk}$	[kN]	8,5
Solid clay brick	$f_b \geq 10 \text{ n/mm}^2$	$F_{Rk}$	[kN]	2,0
	$f_b \geq 20 \text{ n/mm}^2$	$F_{Rk}$	[kN]	3,0
Russian solid clay brick	$f_b \geq 10 \text{ n/mm}^2$	$F_{Rk}$	[kN]	2,0
	$f_b \geq 20 \text{ n/mm}^2$	$F_{Rk}$	[kN]	3,0

### Design resistance

Anchor size		HRV 10		
		$h_{nom}$	[mm]	70
Concrete C16/20 – C50/60		$N_{Rd}$	[kN]	3,3
		$V_{Rd}$	[kN]	6,8
Solid clay brick	$f_b \geq 10 \text{ n/mm}^2$	$F_{Rd}$	[kN]	0,8
	$f_b \geq 20 \text{ n/mm}^2$	$F_{Rd}$	[kN]	1,2
Russian solid clay brick	$f_b \geq 10 \text{ n/mm}^2$	$F_{Rd}$	[kN]	0,8
	$f_b \geq 20 \text{ n/mm}^2$	$F_{Rd}$	[kN]	1,2

### Recommended loads<sup>a)</sup>

Anchor size		HRV 10	
	$h_{nom}$ [mm]	70	
Concrete C16/20 – C50/60	$N_{Rd}$ [kN]	2,4	
	$V_{Rd}$ [kN]	4,8	
Solid clay brick	$f_b \geq 10 \text{ n/mm}^2$	$F_{Rd}$ [kN]	0,57
	$f_b \geq 20 \text{ n/mm}^2$	$F_{Rd}$ [kN]	0,86
Russian solid clay brick	$f_b \geq 10 \text{ n/mm}^2$	$F_{Rd}$ [kN]	0,57
	$f_b \geq 20 \text{ n/mm}^2$	$F_{Rd}$ [kN]	0,86

a) With overall partial safety factor for action  $\gamma = 1,4$ . The partial safety factors for action depend on the type of loading and shall be taken from national regulations.

### Materials



#### Mechanical properties

Anchor size		HRV 10	
		Galvanized steel	Hot-deep galvanized
Nominal tensile strength $f_{uk}$	[N/mm <sup>2</sup> ]	600	600
Yield strength $f_{yk}$	[N/mm <sup>2</sup> ]	480	480
Stressed cross-section $A_s$	tension	27,3	27,3
	shear	28,3	28,3
Moment of resistance $W$	[mm <sup>3</sup> ]	21,2	21,2
Char. Bending resistance $M^0_{Rk,s}$	[Nm]	15,3	15,3

#### Material quality

Part	Material
Sleeve	Polyamide, colour black
Screw	HRV-H
	HRV-HF

#### Masonry base materials

Solid clay brick	Russian solid clay brick
<p>Mz 1,8 DIN 105-100 / EN 771-1 LxWxH [mm]: 240x115x113 hmin [mm]: 115</p> 	<p>Density [kg/dm<sup>3</sup>]: 1,9 LxWxH [mm]: 250x120x65 hmin [mm]: 120</p> 



### Mechanical properties

Anchor size		HRV 10	
		Galvanized steel	Hot-deep galvanized
Nominal tensile strength $f_{uk}$	[N/mm <sup>2</sup> ]	600	600
Yield strength $f_{yk}$	[N/mm <sup>2</sup> ]	480	480
Stressed cross-section $A_s$	tension	27,3	27,3
	shear	28,3	28,3
Moment of resistance $W$	[mm <sup>3</sup> ]	21,2	21,2
Char. Bending resistance $M^{0}_{Rk,s}$	[Nm]	15,3	15,3

### Anchor dimension

Anchor size		HRV 10
Minimum thickness of fixture	$t_{fix,min}$ [mm]	0
Maximum thickness of fixture	$t_{fix,max}$ [mm]	30
Diameter of the sleeve	$d_{nom}$ [mm]	10
Minimum length of the sleeve	$l_{1,min}$ [mm]	80
Maximum length of the sleeve	$l_{1,max}$ [mm]	100
Diameter of plastic washer	$d_{pw}$ [mm]	17,8
Thickness of plastic washer	$t_{pw}$ [mm]	2,5
Diameter of the screw	$d_s$ [mm]	7
Minimum length of the screw	$l_{2,min}$ [mm]	75
Maximum length of the screw	$l_{2,max}$ [mm]	105
Head diameter of hexhead screw	$d_{sw}$ [mm]	17,5

### Anchor sleeve

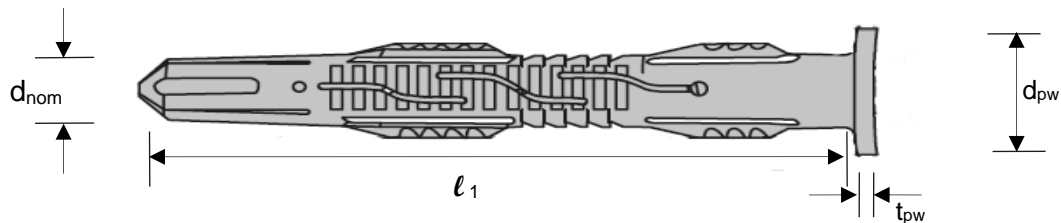

### Special screw

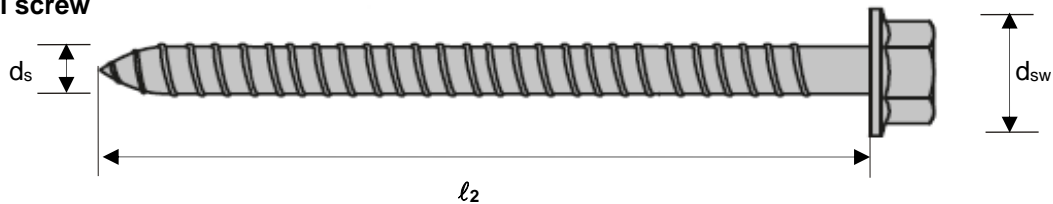

### Setting information

#### Installation temperature

-10°C to +40°C

#### Service temperature range

Hilti HRV frame anchors may be applied in the temperature range given below.

Temperature range	Base material temperature	Max. long term base material temperature	Max. short term base material temperature
Temperature range	-40 °C to +80 °C	+50 °C	+80 °C

### Max short term base material temperature

Short-term elevated base material temperatures are those that occur over brief intervals, e.g. as a result of diurnal cycling.

### Max long term base material temperature

Long-term elevated base material temperatures are roughly constant over significant periods of time.

#### Setting details

Anchor size		HRV 10
Drill hole diameter	$d_o$ [mm]	10
Cutting diameter of drill bit	$d_{cut} \leq$ [mm]	10,45
Depth of drilled hole to deepest point	$h_1 \geq$ [mm]	80
Overall plastic anchor embedment depth in base material	$h_{nom} \geq$ [mm]	70
Diameter of clearance hole in the fixture	$d_f \leq$ [mm]	12

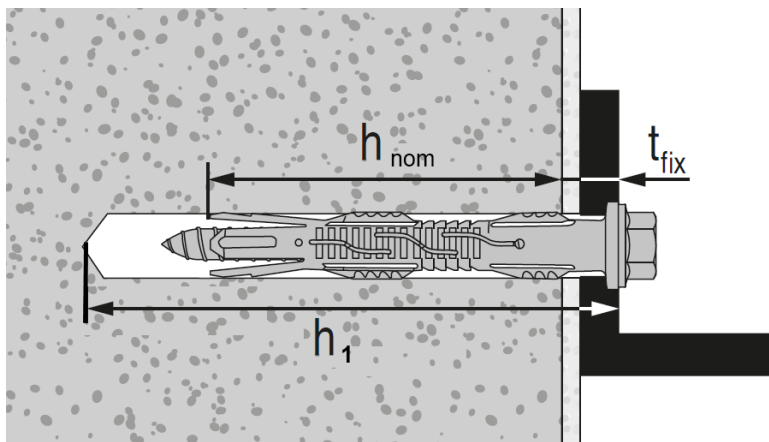

#### Installation equipment

Anchor size		HRV 10
Rotary hammer		TE 2- TE16
Other tools		Hammer, Screwdriver

#### Setting parameters

Anchor size		HRV 10
	$h_{nom}$ [mm]	70
Minimum base material thickness	$h_{min}$ [mm]	120
Minimum spacing	$s_{min}$ [mm]	50
	for $c \geq$ [mm]	100 <sup>a)</sup>
Minimum edge distance	$c_{min}$ [mm]	50
	for $c \geq$ [mm]	150 <sup>a)</sup>
Critical spacing for splitting failure	$s_{cr,sp}$ [mm]	200
Critical edge distance for splitting failure	$c_{cr,sp}$ [mm]	100
Critical spacing for concrete cone failure	$s_{cr,N}$ [mm]	210
Critical edge distance for concrete cone failure	$c_{cr,N}$ [mm]	105

a) Linear interpolation allowed

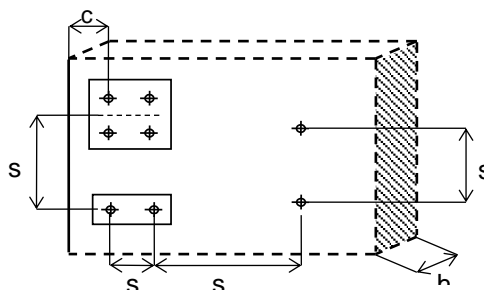

## Setting instruction

\*For detailed information on installation see instruction for use given with the package of the product.

### Setting instruction for HRV

#### 1. Drilling

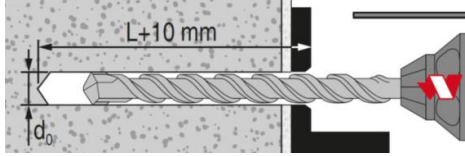

#### 2. Cleaning

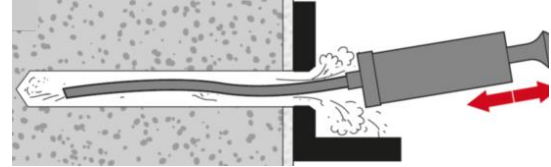

#### 3. Inserting the anchor with hand

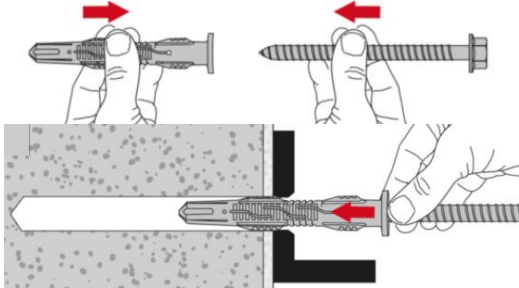

#### 4. Inserting the anchor with hammer

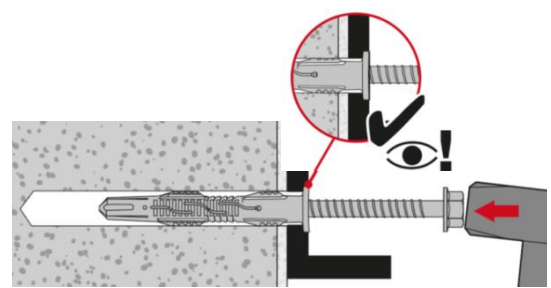

#### 5. Inserting the tools

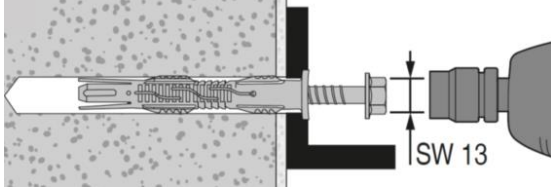

#### 6. Checking

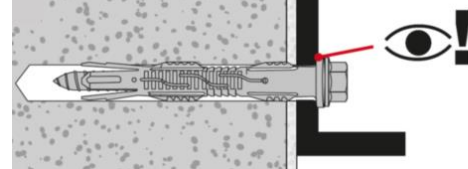



Chemical anchors

Mechanical anchors

**Plastic/Light duty metal anchors**

Insulation anchors

# HPS-1 Plastic anchors

## Economical plastic impact anchor

### Anchor version



HPS-1  
(M4-M8)

### Benefits

- Impact anchor for light frames, battens and profiles on solid base materials
- Impact and temperature resistant
- High quality plastic

### Base material



Concrete  
(non-cracked)

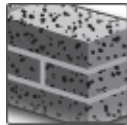

Solid brick

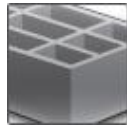

Hollow brick

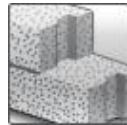

Autoclaved  
aerated  
concrete

### Basic loading data

#### All data in this section applies to:

- Correct setting (See setting instruction)
- No edge distance and spacing influence
- Base material as specified in the table
- Minimum base material thickness
- Loads shall be reduced if the temperature sustains above 40°C

#### Recommended loads<sup>a)</sup>

Anchor size		4/0	5/0	5/5- 5/15	6/0- 6/25	6/30- 6/40	8/0	8/10- 8/40	8/60- 8/100
Concrete $\geq$ C16/20	$N_{Rd}$ [kN]	0,05	0,10	0,15	0,25	0,25	0,30	0,40	0,40
	$V_{Rd}$ [kN]	0,15	0,30	0,35	0,55	0,35	0,50	0,90	0,50
Engineering brick, 12 hole, class B	$N_{Rd}$ [kN]	0,05	0,10	0,15	0,25	0,25	0,30	0,40	0,40
	$V_{Rd}$ [kN]	0,15	0,30	0,35	0,55	0,35	0,50	0,90	0,50
Perforated brick 3 hole common	$N_{Rd}$ [kN]	0,05	0,10	0,15	0,20	0,20	0,25	0,30	0,30
	$V_{Rd}$ [kN]	0,15	0,30	0,35	0,55	0,35	0,50	0,90	0,55
Thermalite block, 7 N lightweights	$N_{Rd}$ [kN]	-	-	0,08	0,15	0,15	0,20	0,25	0,25
	$V_{Rd}$ [kN]	-	-	0,15	0,25	0,15	0,40	0,40	0,25
Thermalite block, 1/2 N lightweights	$N_{Rd}$ [kN]	-	-	0,05	0,08	0,08	-	0,12	0,12
	$V_{Rd}$ [kN]	-	-	0,10	0,15	0,10	-	0,25	0,15
Autoclaved aerated concrete AAC 4, ACC 6	$N_{Rd}$ [kN]	-	-	0,08	0,10	0,10	-	0,15	0,15
	$V_{Rd}$ [kN]	-	-	0,10	0,12	0,10	-	0,30	0,20
Extruded brick, Boral 10	$N_{Rd}$ [kN]	0,05	0,10	0,15	0,20	0,20	0,25	0,35	0,35
	$V_{Rd}$ [kN]	0,15	0,25	0,30	0,40	0,25	0,50	0,90	0,55

a) With overall global safety factor  $\gamma = 5$  to the characteristic loads and a partial safety factor of  $\gamma = 1,4$  to the design values.

## Materials

### Material quality

Part	Material
Plastic sleeve	Polyamide 6.6
Screw	Carbon steel, galvanised to min. 5µm
	Stainless steel, grade A2
	Stainless steel, grade A2, copper-plated

## Setting information

### Installation temperature

-10 °C to +40°C

### Service temperature range

Hilti HPS-1 impact anchor may be applied in the temperature range below.

Temperature range	Base material temperature	Max. long term base material temperature	Max. short term base material temperature
Temperature range	-40 °C to +80 °C	+50 °C	+80 °C

### Max. short term base material temperature

Short-term elevated base material temperatures are those that occur over brief intervals, e.g. as a result of diurnal cycling.

### Max. long term base material temperature

Long-term elevated base material temperatures are roughly constant over significant periods of time.

## Setting details HPS-1

Anchor		HPS-1 4	HPS-1 5	HPS-1 6	HPS-1 8
Nominal diameter of drill bit	$d_o$ [mm]	4	5	6	8
Cutting diameter of drill bit	$d_{cut} \leq$ [mm]	4,35	5,35	6,4	8,45
Depth of drill hole	$h_1 \geq$ [mm]	25	30	40	50
Nominal embedment depth	$h_{nom}$ [mm]	20	20	25	30
Anchor length	$l$ [mm]	21,5	22 - 37	27 - 67	28,5 - 132,5
Max fixture thickness	$t_{fix}$ [mm]	2	15	40	100

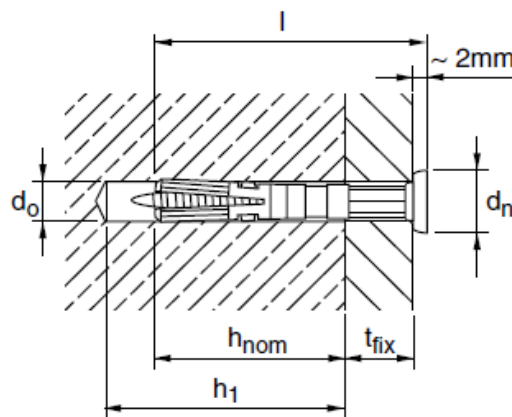

### Installation equipment

Anchor	HPS-1 4	HPS-1 5	HPS-1 6	HPS-1 8
Rotary hammer	TE2 - TE16			
Other tools	Screwdriver			

### Setting parameters HPS-1

Anchor	HPS-1 4	HPS-1 5	HPS-1 6	HPS-1 8
Spacing	s [mm]	20	25	30
Edge distance	c [mm]	20	25	30

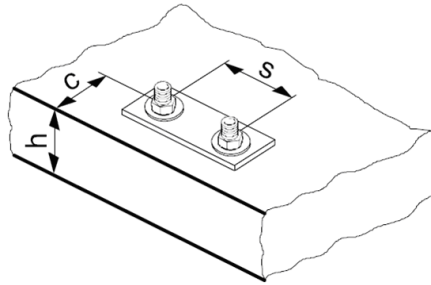

### Setting instruction

\*For detailed information on installation see instruction for use given with the package of the product.

#### Setting instructions

<p><b>1. Drill hole with drill bit</b></p>	<p><b>2. Install anchor</b></p>	<p><b>3. Hammer in anchor</b></p>
--	---------------------------------	-----------------------------------





Chemical anchors

Mechanical anchors

**Plastic/Light duty metal anchors**

Insulation anchors

# HUD-1 Plastic anchor

Economical universal plastic anchor

## Anchor version



HUD-1  
(M5-M14)

## Benefits

- Flat setting
- Flexibility of screw length
- An anchor for every base material

## Base material



Concrete  
(non-cracked)

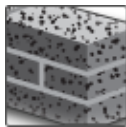

Solid brick

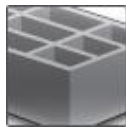

Hollow brick

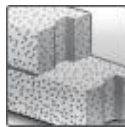

Autoclaved  
aerated  
concrete



Drywall

## Basic loading data

### All data in this section applies to:

- Correct setting (See setting instruction)
- Load data are only valid for the specified woodscrew type
- No edge distance and spacing influence
- Base material as specified in the table
- Minimum base material thickness

**Characteristic resistance**

Anchor size		5x25		6x30		8x40		10x50		12x60	14x70
Screw type <sup>d)</sup>		W	C	W	C	W	C	W	C	W	W
Size		4	4	5	5	6	6	8	8	10	12
DIN		96		96		96		96		571	571
Concrete ≥ C16/20	N <sub>Rk</sub> [kN]	1,5	0,5	2,75	1,75	4,25	2,5	7	-	10	15
	V <sub>Rk</sub> [kN]	2	-	4,5	-	6,25	-	11	-	15	28
Solid clay brick Mz 20	N <sub>Rk</sub> [kN]	0,85	0,3	1,75	0,75	3	1,75	4	-	5	5 <sup>a)</sup>
	V <sub>Rk</sub> [kN]	1,2	-	1,5	-	2,2	-	-	-	-	-
Solid sand-lime brick KS 12	N <sub>Rk</sub> [kN]	1,25	0,75	2,5	1,5	4,25	2	5	-	7,5	7,5 <sup>a)</sup>
	V <sub>Rk</sub> [kN]	1,25	-	2,8	-	3,7	-	6,6	-	-	-
Hollow clay brick HlzB 12	N <sub>Rk</sub> [kN]	0,4	0,25	0,5	0,4	1	0,6	1,25	-	1,4	1,6
	V <sub>Rk</sub> [kN]	1,15	-	1,75	-	-	-	-	-	-	-
Hollow clay brick HlzB 12 – 15mm plastered	N <sub>Rk</sub> [kN]	0,4	0,25	0,75	0,5	1,25	0,75	1,5	-	1,75	2
	V <sub>Rk</sub> [kN]	1,15	-	1,75	-	-	-	-	-	-	-
Autoclaved aerated concrete AAC 2	N <sub>Rk</sub> [kN]	0,3	0,2	0,5	0,3	0,75	0,5	1	-	1,25	1,5
	V <sub>Rk</sub> [kN]	0,2	-	0,25	-	0,4	-	-	-	-	-
Autoclaved aerated concrete AAC 4	N <sub>Rk</sub> [kN]	0,5	0,3	0,75	0,5	1,5	1	2	-	2,5	3
	V <sub>Rk</sub> [kN]	0,65	-	0,9	-	1,5	-	-	-	-	-
Gypsum board Thickness 12,5mm	N <sub>Rk</sub> [kN]	0,2	0,3	0,25	0,4	0,3	0,5	-	0,75 <sup>b)</sup>	-	-
	V <sub>Rk</sub> [kN]	0,45	-	0,7	-	-	-	-	-	-	-
Gypsum board Thickness 2x12,5mm	N <sub>Rk</sub> [kN]	0,3	0,3	0,4	0,4	0,5	0,5	0,75 <sup>b)</sup>	1 <sup>b)</sup>	1,5 <sup>c)</sup>	-
	V <sub>Rk</sub> [kN]	0,45	-	0,7	-	-	-	-	-	-	-
Fibre reinforced gypsum board Thickness 12,5mm	N <sub>Rk</sub> [kN]	0,45	-	0,6	-	0,9	-	-	-	-	-
	V <sub>Rk</sub> [kN]	0,72	-	0,96	-	1,44	-	-	-	-	-
Fibre reinforced gypsum board Thickness 2x12,5mm	N <sub>Rk</sub> [kN]	0,45	-	1,2	-	1,8	-	2,1	-	-	-
	V <sub>Rk</sub> [kN]	0,72	-	1,92	-	2,88	-	3,36	-	-	-

a) only with screw diameter 6mm

b) only with screw diameter 8mm

c) only with screw diameter 10mm

d) Screw type: W: Wood-screw C: Chipboard screw

Load data are valid for the mentioned woodscrew type, if other types or different screws are used the load capacity may decrease.

**Design resistance**

Anchor size		5x25		6x30		8x40		10x50		12x60	14x70
Screw type <sup>d)</sup>		W	C	W	C	W	C	W	C	W	W
Size		4	4	5	5	6	6	8	8	10	12
DIN		96		96		96		96		571	571
Concrete ≥ C16/20	N <sub>Rd</sub> [kN]	0,42	0,14	0,77	0,49	1,19	0,70	1,96	-	2,80	4,20
	V <sub>Rd</sub> [kN]	0,56	-	1,26	-	1,75	-	3,08	-	4,20	7,84
Solid clay brick Mz 20	N <sub>Rd</sub> [kN]	0,24	0,08	0,49	0,21	0,84	0,49	1,12	-	1,40	1,40 <sup>c)</sup>
	V <sub>Rd</sub> [kN]	0,34	-	0,42	-	0,62	-	-	-	-	-
Solid sand-lime brick KS 12	N <sub>Rd</sub> [kN]	0,35	0,21	0,70	0,42	1,19	0,56	1,40	-	2,10	2,10 <sup>c)</sup>
	V <sub>Rd</sub> [kN]	0,35	-	0,78	-	1,04	-	1,85	-	-	-
Hollow clay brick HlzB 12	N <sub>Rd</sub> [kN]	0,11	0,07	0,14	0,11	0,28	0,17	0,35	-	0,39	0,45
	V <sub>Rd</sub> [kN]	0,32	-	0,49	-	-	-	-	-	-	-
Hollow clay brick HlzB 12 – 15mm plastered	N <sub>Rd</sub> [kN]	0,11	0,07	0,21	0,14	0,35	0,21	0,42	-	0,49	0,56
	V <sub>Rd</sub> [kN]	0,32	-	0,49	-	-	-	-	-	-	-
Autoclaved aerated concrete AAC 2	N <sub>Rd</sub> [kN]	0,08	0,06	0,14	0,08	0,21	0,14	0,28	-	0,35	0,42
	V <sub>Rd</sub> [kN]	0,06	-	0,07	-	0,11	-	-	-	-	-
Autoclaved aerated concrete AAC 4	N <sub>Rd</sub> [kN]	0,14	0,08	0,21	0,14	0,42	0,28	0,56	-	0,70	0,84
	V <sub>Rd</sub> [kN]	0,18	-	0,25	-	0,42	-	-	-	-	-
Gypsum board Thickness 12,5mm	N <sub>Rd</sub> [kN]	0,06	0,08	0,07	0,11	0,08	0,14	-	0,21 <sup>a)</sup>	-	-
	V <sub>Rd</sub> [kN]	0,13	-	0,20	-	-	-	-	-	-	-
Gypsum board Thickness 2x12,5mm	N <sub>Rd</sub> [kN]	0,08	0,08	0,11	0,11	0,14	0,14	0,21 <sup>a)</sup>	0,28 <sup>a)</sup>	0,42 <sup>b)</sup>	
	V <sub>Rd</sub> [kN]	0,13	-	0,20	-	-	-	-	-	-	-
Fibre reinforced gypsum board Thickness 12,5mm	N <sub>Rd</sub> [kN]	0,13	-	0,17	-	0,25	-	-	-	-	-
	V <sub>Rd</sub> [kN]	0,20	-	0,27	-	0,40	-	-	-	-	-
Fibre reinforced gypsum board Thickness 2x12,5mm	N <sub>Rd</sub> [kN]	0,13	-	0,34	-	0,50	-	0,59	-	-	-
	V <sub>Rd</sub> [kN]	0,20	-	0,54	-	0,81	-	0,94	-	-	-

a) only with screw diameter 6mm

b) only with screw diameter 8mm

c) only with screw diameter 10mm

d) Screw type: W: Wood-screw C: Chipboard screw

Load data are valid for the mentioned woodscrew type, if other types or different screws are used the load capacity may decrease.

**Recommended loads<sup>e)</sup>**

Anchor size		5x25		6x30		8x40		10x50		12x60	14x70
Screw type <sup>d)</sup>		W	C	W	C	W	C	W	C	W	W
Concrete ≥ C16/20	N <sub>Rec</sub> [kN]	0,3	0,1	0,55	0,35	0,85	0,5	1,4	-	2	3
	V <sub>Rec</sub> [kN]	0,4	-	0,9	-	1,25	-	2,2	-	3	5,6
Solid clay brick Mz 20	N <sub>Rec</sub> [kN]	0,17	0,06	0,35	0,15	0,6	0,35	0,8	-	1	1
	V <sub>Rec</sub> [kN]	0,24	-	0,3	-	0,44	-	-	-	-	-
Solid sand-lime brick KS 12	N <sub>Rec</sub> [kN]	0,25	0,15	0,5	0,3	0,85	0,4	1	-	1,5	1,5
	V <sub>Rec</sub> [kN]	0,25	-	0,56	-	0,74	-	1,32	-		
Hollow clay brick HlzB 12	N <sub>Rec</sub> [kN]	0,08	0,05	0,1	0,08	0,2	0,12	0,25	-	0,28	0,32
	V <sub>Rec</sub> [kN]	0,23	-	0,35	-	-	-	-	-	-	-
Hollow clay brick HlzB 12 – 15mm plastered	N <sub>Rec</sub> [kN]	0,08	0,05	0,15	0,1	0,25	0,15	0,3	-	0,35	0,4
	V <sub>Rec</sub> [kN]	0,23	-	0,35	-	-	-	-	-	-	-
Autoclaved aerated concrete AAC 2	N <sub>Rec</sub> [kN]	0,06	0,04	0,1	0,06	0,15	0,1	0,2	-	0,25	0,3
	V <sub>Rec</sub> [kN]	0,04	-	0,05		0,08			-		
Autoclaved aerated concrete AAC 4	N <sub>Rec</sub> [kN]	0,1	0,06	0,15	0,1	0,3	0,2	0,4	-	0,5	0,6
	V <sub>Rec</sub> [kN]	0,13	-	0,18	-	0,3	-	-	-	-	-
Gypsum board Thickness 12,5mm	N <sub>Rec</sub> [kN]	0,04	0,06	0,05	0,08	0,06	0,1	-	0,15	-	-
	V <sub>Rec</sub> [kN]	0,09	-	0,14	-	-	-	-	-	-	-
Gypsum board Thickness 2x12,5mm	N <sub>Rec</sub> [kN]	0,06	0,06	0,08	0,08	0,1	0,1	0,15	0,2	0,3	-
	V <sub>Rec</sub> [kN]	0,09	-	0,14	-	-	-	-	-	-	-
Fibre reinforced gypsum board Thickness 12,5mm	N <sub>Rec</sub> [kN]	0,09	-	0,12	-	0,18	-	-	-	-	-
	V <sub>Rec</sub> [kN]	0,14	-	0,19	-	0,29	-	-	-	-	-
Fibre reinforced gypsum board Thickness 2x12,5mm	N <sub>Rec</sub> [kN]	0,09	-	0,24	-	0,36	-	0,42	-	-	-
	V <sub>Rec</sub> [kN]	0,14	-	0,38	-	0,58	-	0,67	-	-	-

a) only with screw diameter 6mm

b) only with screw diameter 8mm

c) only with screw diameter 10mm

d) Screw type: W: Wood-screw C: Chipboard screw

Load data are valid for the mentioned woodscrew type, if other types or different screws are used the load capacity may decrease.

e) With overall global safety factor  $\gamma = 5$  to the characteristic loads and a partial safety factor of  $\gamma = 1,4$  to the design values.

**Materials**
**Material quality**

Part	Material
Plastic sleeve	Polyamide 6

## Setting information

### Service temperature range

Hilti HUD-1 universal anchor may be applied in the temperature range given below.

Temperature range	Base material temperature	Max. long term base material temperature	Max. short term base material temperature
Temperature range	-40 °C to +80 °C	+50 °C	+80 °C

### Max short term base material temperature

Short-term elevated base material temperatures are those that occur over brief intervals, e.g. as a result of diurnal cycling.

### Max long term base material temperature

Long-term elevated base material temperatures are roughly constant over significant periods of time.

## Setting details

Anchor size		5x25	6x30	8x40	10x50	12x60	14x70
Nominal diameter of drill bit	$d_o$ [mm]	5	6	8	10	12	14
Cutting diameter of drill bit	$d_{cut} \leq$ [mm]	5,35	6,4	8,45	10,45	12,5	14,5
Depth of drill hole	$h_1 \geq$ [mm]	35	40	55	65	80	90
Effective anchorage depth	$h_{nom}$ [mm]	25	30	40	50	60	70
Anchor length	$l$ [mm]	25	30	40	50	60	70
Max fixture thickness	$t_{fix}$ [mm]	Depending on screw length					
Installation temperature	[°C]	-10 to +40					
Woodscrew diameter <sup>a)</sup>	$d$ [mm]	3,5 - 4	4,5 - 5	5 - 6	7 - 8	8 - 10	10 - 12

a) The basic loading data are depending on the woodscrew diameters, if other types or different screws are used the load capacity may decrease. Highlighted diameters refer to basic loading data table, except footnotes <sup>a), b), c)</sup> of basic loading data tables.

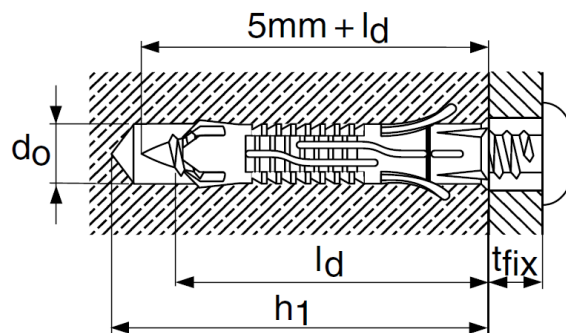

## Installation equipment

Anchor size	5x25	6x30	8x40	10x50	12x60	14x70	5x25
Rotary hammer	TE 2- TE16						
Other tools	Screwdriver						

Setting instruction<sup>a)</sup>

\*For detailed information on installation see instruction for use given with the package of the product.

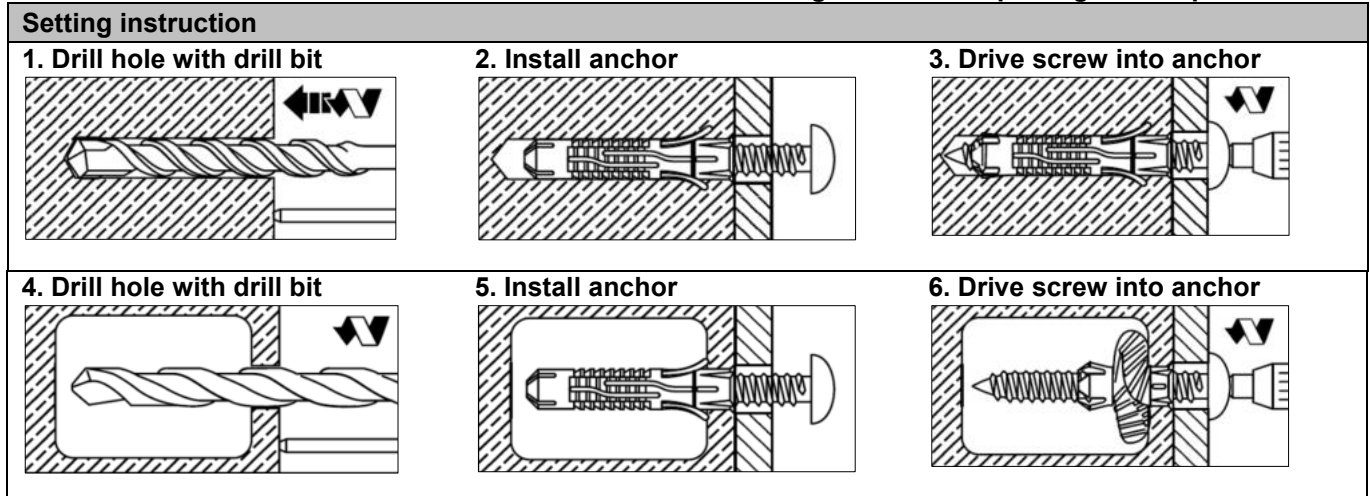

a) Use only for wall and floor applications. Not applicable for ceiling and façade applications.



# HUD-L Plastic anchors

## Economical universal long plastic anchor

### Anchor version



HUD-L  
(M6-M8)



HUD-L  
(M10)

### Benefits

- Universal plastic anchor for weak base materials and renovation
- For many base materials
- Daily application
- Excellent setting behaviour

### Base material



Concrete

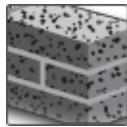

Solid brick

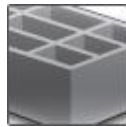

Hollow brick

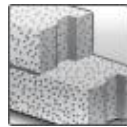

Autoclaved  
aerated  
concrete



Drywall

### Basic loading data

#### All data in this section applies to:

- Correct setting (See setting instruction)
- Load data are only valid for the specified woodscrew type
- Load data given in the tables is independent of load direction
- No edge distance and spacing influence
- Base material as specified in the table
- Minimum base material thickness

### Characteristic resistance

Anchor size		6x50	8x60	10x70
Screw type <sup>c) d)</sup>		W	W	W
Size		4,5x80	5x90	8
DIN		96	96	571
Concrete ≥ C16/20	F <sub>Rk</sub> [kN]	1,15	1,4	9,0
Solid clay brick Mz 12	F <sub>Rk</sub> [kN]	0,85	1,0	-
Solid clay brick Mz 20	F <sub>Rk</sub> [kN]	-	-	7,0
Solid sand-lime brick KS 12	F <sub>Rk</sub> [kN]	0,85	1,0	2
Hollow clay brick Hlz 12 <sup>a)</sup>	F <sub>Rk</sub> [kN]	0,5	0,75	1,5
Hollow sand-lime brick KSL 12	F <sub>Rk</sub> [kN]	0,7	0,8	-
Autoclaved aerated concrete AAC 2 <sup>a)</sup>	F <sub>Rk</sub> [kN]	0,25	0,55	2,0
Gypsum board Thickness 2x12,5mm <sup>a)</sup>	F <sub>Rk</sub> [kN]	0,3	0,7	0,6 <sup>b)</sup>

a) Drilling without hammering

b) Suitable for fitting hexagonal screws by hand

c) Load data are valid for the mentioned woodscrew type, if other types or different screws are used the load capacity may decrease.

d) Screw type: W: Wood-screw

## Design resistance

Anchor size		6x50	8x60	10x70
Screw type <sup>c) d)</sup>		W	W	W
Size		4,5x80	5x90	8
DIN		96	96	571
Concrete $\geq$ C16/20	$F_{Rd}$ [kN]	0,32	0,39	2,52
Solid clay brick Mz 12	$F_{Rd}$ [kN]	0,24	0,28	-
Solid clay brick Mz 20	$F_{Rd}$ [kN]	-	-	1,96
Solid sand-lime brick KS 12	$F_{Rd}$ [kN]	0,24	0,28	0,56
Hollow clay brick Hlz 12 <sup>a)</sup>	$F_{Rd}$ [kN]	0,14	0,21	0,42
Hollow sand-lime brick KSL 12	$F_{Rd}$ [kN]	0,20	0,22	-
Autoclaved aerated concrete AAC 2 <sup>a)</sup>	$F_{Rd}$ [kN]	0,07	0,15	0,56
Gypsum board Thickness 2x12,5mm <sup>a)</sup>	$F_{Rd}$ [kN]	0,08	0,20	0,17 <sup>b)</sup>

a) Drilling without hammering

b) Suitable for fitting hexagonal screws by hand

c) Load data are valid for the mentioned woodscrew type, if other types or different screws are used the load capacity may decrease.

d) Screw type: W: Wood-screw

## Recommended loads <sup>e)</sup>

Anchor size		6x50	8x60	10x70
Screw type <sup>c) d)</sup>		W	W	W
Size		4,5x80	5x90	8
DIN		96	96	571
Concrete $\geq$ C16/20	$F_{Rec}$ [kN]	0,23	0,28	1,8
Solid clay brick Mz 12	$F_{Rec}$ [kN]	0,17	0,2	-
Solid clay brick Mz 20	$F_{Rec}$ [kN]	-	-	1,4
Solid sand-lime brick KS 12	$F_{Rec}$ [kN]	0,17	0,2	0,4
Hollow clay brick Hlz 12 <sup>a)</sup>	$F_{Rec}$ [kN]	0,1	0,15	0,3
Hollow sand-lime brick KSL 12	$F_{Rec}$ [kN]	0,14	0,16	-
Autoclaved aerated concrete AAC 2 <sup>a)</sup>	$F_{Rec}$ [kN]	0,05	0,11	0,4
Gypsum board Thickness 2x12,5mm <sup>a)</sup>	$F_{Rec}$ [kN]	0,06	0,14	0,12 <sup>b)</sup>

a) Drilling without hammering

b) Suitable for fitting hexagonal screws by hand

c) Load data are valid for the mentioned woodscrew type, if other types or different screws are used the load capacity may decrease.

d) Screw type: W: Wood-screw

e) With overall global safety factor  $\gamma = 5$  to the characteristic loads and a partial safety factor of  $\gamma = 1,4$  to the design values.

## Materials

### Material quality

Part	Material
Plastic sleeve	Polyamide 6

## Setting information

### Installation temperature

-10°C to + 40°C

### Service temperature range

Hilti HUD-L universal anchor may be applied in the temperature range given below.

Temperature range	Base material temperature	Max. long term base material temperature	Max. short term base material temperature
Temperature range	-40 °C to +80 °C	+50 °C	+80 °C

### Max short term base material temperature

Short-term elevated base material temperatures are those that occur over brief intervals, e.g. as a result of diurnal cycling.

### Max long term base material temperature

Long-term elevated base material temperatures are roughly constant over significant periods of time.

Anchor size		6x50	8x60	10x70
Nominal diameter of drill bit	$d_o$ [mm]	6	8	10
Cutting diameter of drill bit	$d_{cut} \leq$ [mm]	6,4	8,45	10,45
Depth of drill hole	$h_1 \geq$ [mm]	70	80	90
Effective anchorage depth	$h_{nom}$ [mm]	47	57	70
Anchor length	$l$ [mm]	47	57	70
Max fixture thickness	$t_{fix}$ [mm]	Depending on screw length		
Recommended length of screw in base material	$l_d$ [mm]	55	65	75
Woodscrew diameter <sup>a)</sup>	$d$ [mm]	<b>4,5 - 5</b>	<b>5 - 6</b>	<b>7 - 8</b>

a) The basic loading data are depending on the woodscrew diameters, if other types or different screws are used the load capacity may decrease. Highlighted diameters refer to basic loading data table, except footnotes <sup>a), b), c)</sup> of basic loading data tables.

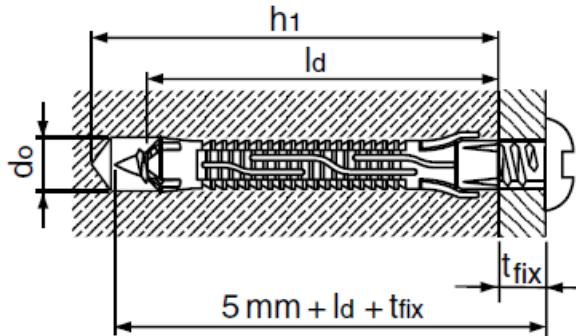

### Installation equipment

Anchor size	6x50	8x60	10x70
Rotary hammer		TE 2- TE16	
Other tools		Screwdriver	

### Setting instruction <sup>a)</sup>

\*For detailed information on installation see instruction for use given with the package of the product.

Setting instruction		
<b>1. Drill hole with drill bit</b> 	<b>2. Install anchor</b> 	<b>3. Put part being fastened in place and drive screw into anchor.</b> 
<b>4. Drill hole with drill bit</b> 	<b>5. Put part being fastened in place and install anchor</b> 	<b>6. Drive screw into anchor</b> 

a) Use only for wall and floor applications. Not applicable for ceiling and façade applications.



Chemical anchors

Mechanical anchors

**Plastic/Light duty metal anchors**

Insulation anchors

# HLD Plastic anchors

Economical plastic anchor for drywall

## Anchor version



HLD  
(M10)

## Benefits

- Plastic undercut anchor
- Simple setting
- Drywall application

## Base material



Drywall

## Basic loading data

### All data in this section applies to:

- Correct setting (See setting instruction)
- No edge distance and spacing influence
- Base material as specified in the table
- Load data given in the tables is independent of load direction

### Characteristic resistance

Anchor size				HLD 2	HLD 3	HLD 4
Anchoring principle <sup>a)</sup>						
Gypsum board Thickness 12,5mm	B	$F_{Rk}$	[kN]	0,4	0,4	0,4
Fibre reinforced gypsum board	A	$F_{Rk}$	[kN]	0,3	-	-
Fibre reinforced gypsum board Thickness 2x12,5mm	A	$F_{Rk}$	[kN]	-	0,6	-
Hollow clay brick	A / B	$F_{Rk}$	[kN]	0,75	0,75	
Concrete $\geq$ C16/20	C	$F_{Rk}$	[kN]	1,25	2	2,5

<sup>a)</sup> See setting details

### Design resistance

Anchor size				HLD 2	HLD 3	HLD 4
Anchoring principle <sup>a)</sup>						
Gypsum board Thickness 12,5mm	B	$F_{Rd}$	[kN]	0,11	0,11	0,11
Fibre reinforced gypsum board	A	$F_{Rd}$	[kN]	0,08	-	-
Fibre reinforced gypsum board Thickness 2x12,5mm	A	$F_{Rd}$	[kN]	-	0,17	-
Hollow clay brick	A / B	$F_{Rd}$	[kN]	0,21	0,21	-
Concrete $\geq$ C16/20	C	$F_{Rd}$	[kN]	0,35	0,56	0,70

<sup>a)</sup> See setting detail

### Recommended loads <sup>b)</sup>

Anchor size			HLD 2	HLD 3	HLD 4
Anchoring principle <sup>a)</sup>					
Gypsum board Thickness 12,5mm	B	F <sub>Rec</sub> [kN]	0,08	0,08	0,08
Fibre reinforced gypsum board	A	F <sub>Rec</sub> [kN]	0,06	-	-
Fibre reinforced gypsum board Thickness 2x12,5mm	A	F <sub>Rec</sub> [kN]	-	0,12	-
Hollow clay brick	A / B	F <sub>Rec</sub> [kN]	0,15	0,15	
Concrete ≥ C16/20	C	F <sub>Rec</sub> [kN]	0,25	0,4	0,5

a) See setting details

b) With overall global safety factor  $\gamma = 5$  to the characteristic loads and a partial safety factor of  $\gamma = 1,4$  to the design value.

### Materials

#### Material quality

Part	Material
Sleeve	Polyamide PA 6

### Setting information

#### Installation temperature

-10°C to + 40°C

#### Service temperature range

Hilti HLD universal anchor may be applied in the temperature range given below.

Temperature range	Base material temperature	Max. long term base material temperature	Max. short term base material temperature
Temperature range	-40 °C to +80 °C	+50 °C	+80 °C

#### Max short term base material temperature

Short-term elevated base material temperatures are those that occur over brief intervals, e.g. as a result of diurnal cycling.

#### Max long term base material temperature

Long-term elevated base material temperatures are roughly constant over significant periods of time.

### Setting details

Anchor size			HLD 2	HLD 3	HLD 4
Nominal diameter of drill bit	d <sub>o</sub>	[mm]	10		
Depth of drill hole	(only anchoring principle C)	h <sub>1</sub> ≥ [mm]	50	56	66
Screw length	(anchoring principle A/B)	l <sub>s</sub> [mm]	33 + t <sub>fix</sub>	40 + t <sub>fix</sub>	49 + t <sub>fix</sub>
	(anchoring principle C)	l <sub>s</sub> [mm]	40 + t <sub>fix</sub>	46 + t <sub>fix</sub>	56 + t <sub>fix</sub>
Screw diameter	(anchoring principle A/B)	d <sub>s</sub> [mm]	4 - 5		
	(anchoring principle C)	d <sub>s</sub> [mm]	5 - 6		
Wall / panel thickness	(anchoring principle A)	h [mm]	4 - 12	15 - 19	24 - 28
	(anchoring principle B)	h [mm]	12 - 16	19 - 25	28 - 32
	(anchoring principle C)	h	35	42	50

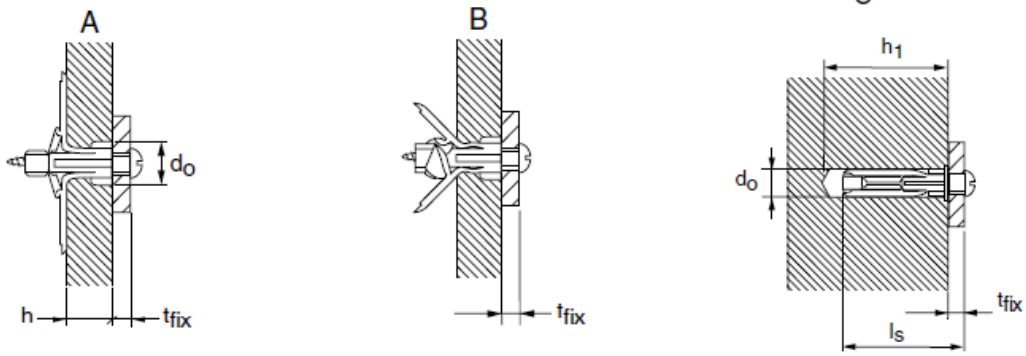

### Installation equipment

Anchor size	HLD 2	HLD 3	HLD 4
Rotary hammer	TE 2- TE16		
Other tools	Screwdriver		

### Setting instruction

\*For detailed information on installation see instruction for use given with the package of the product.

Setting instruction	
<b>1. Drill hole with drill bit</b> 	<b>2. Install anchor</b> 
<b>3. Install anchor</b> 	<b>4. Drive in the screw</b> 





Chemical anchors

Mechanical anchors

**Plastic/Light duty metal anchors**





Insulation anchors

# HMF plastic anchor

## Economical universal plastic anchor

### Anchor version

### Benefits

	HMF	<ul style="list-style-type: none"> <li>- Flat setting</li> <li>- An anchor for every base material</li> <li>- Suitable for fastening through in-place parts</li> <li>- Resists rotation in hole and premature expansion</li> <li>- High reliability and precise screw guidance, 360° expansion</li> </ul>
	CS: Countersunk screw	
	PH: Pan head screw	
	HH: Hexagonal head screw	

### Base material



Concrete (non-cracked)

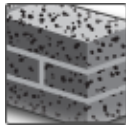

Solid brick

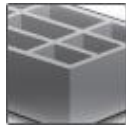

Hollow brick

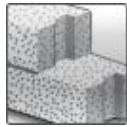

Autoclaved aerated concrete







Drywall

### Basic loading data

**All data in this section applies to:**

- Correct setting (See setting instruction)
- Load data are only valid for the specified screw types
- No edge distance and spacing influence
- Base material as specified in the table
- Minimum base material thickness

**Recommended loads <sup>a)</sup> for all load directions**

Anchor size		HMF 5x25	HMF 6x30	HMF 8x40	HMF 10x50	HMF 12x60	HMF 14x70
Screw type <sup>b)</sup>		CS F PH 4	CS 4,5 PH 4,5	CS 5 PH 5 HH 5	CS 7 PH 7 HH 7	HH 8	HH 10
<b>Non-cracked concrete</b> $\geq$ C16/20	$F_{Rec}$ [kN]	0,25	0,30	0,40	1,00	1,40	1,40
<b>Solid clay brick</b> size: 230x110x60 strength: $f_{c,test} \geq 20$ [N/mm <sup>2</sup> ] density: 2000 [kg/m <sup>3</sup> ]	$F_{Rec}$ [kN]	0,15	0,15	0,20	0,80	0,80	0,80
<b>Autoclaved aerated concrete AAC2</b> size: 600x175x200 strength: 2 [N/mm <sup>2</sup> ] density: 390[kg/m <sup>3</sup> ]	$F_{Rec}$ [kN]	0,02	0,04	0,05	0,10	0,15	0,15
<b>Autoclaved aerated concrete AAC4</b> size: 625x250x250 strength: 4,0 [N/mm <sup>2</sup> ] density: 600 [kg/m <sup>3</sup> ]	$F_{Rec}$ [kN]	0,04	0,06	0,10	0,18	0,18	0,22
<b>Hollow clay brick</b> type: Tramezza "Tavella" manufacturer: Fornace Tempora size: 200x250x30 strength: 25 [N/mm <sup>2</sup> ] density: 2000 [kg/m <sup>3</sup> ]	 $F_{Rec}$ [kN]	0,10	0,10	0,20	0,20	N/A <sup>c)</sup>	0,35
<b>Hollow clay brick</b> type: "Doppio Uni" manufacturer: Fornace S. Antonio size: 120x120x240 strength: 20 [N/mm <sup>2</sup> ] density: 2000 [kg/m <sup>3</sup> ]	 $F_{Rec}$ [kN]	0,10	0,10	0,15	0,25	0,45	0,45
<b>Hollow clay brick</b> type: Poroton "Blocchi portanti" manufacturer: Fornace S. Antonio size: 300x200x200 strength: 10 [N/mm <sup>2</sup> ] density: 2000 [kg/m <sup>3</sup> ]	 $F_{Rec}$ [kN]	0,10	0,10	0,10	0,20	0,20	0,20
<b>Hollow clay brick</b> type: Pignata "Blocchi intermedi" manufacturer: Fornace S. Antonio size: 120x120x240 strength: 25 [N/mm <sup>2</sup> ] density: 2000 [kg/m <sup>3</sup> ]	 $F_{Rec}$ [kN]	0,10	0,10	0,10	0,25	N/A <sup>c)</sup>	N/A <sup>c)</sup>
<b>Drywall</b> manufacturer: Knauf size: thickness 12,5 [mm] density: 680 [kg/m <sup>3</sup> ]	$F_{Rec}$ [kN]	0,02 <sup>d)</sup>	0,04	0,04	0,04	N/A <sup>c)</sup>	N/A <sup>c)</sup>
<b>Drywall with fibers</b> manufacturer: Knauf size: thickness 12,5 [mm] density: 1200 [kg/m <sup>3</sup> ]	$F_{Rec}$ [kN]	0,03	0,20	0,20	0,20	0,35	0,35

- a) Performance assessment based on statistical evaluation of the ultimate loads, including the effect of drill bit wear, conditioning and different installation and in-service temperatures, load-displacement behaviour and scatter of the results. Based on that assessment a partial safety concept is used with  $\gamma_{M,concrete} = 1,8$ ;  $\gamma_{M,AAC} = 2,1$ ;  $\gamma_{M,masonry} = 2,5$  additional load safety factor of  $\gamma_{G,Q} = 1,4$ .
- b) CS: Countersunk, PH: Pan head, HH hexagonal head; screws are specified by Hilti and can be ordered with the plastic body.
- c) Not applicable
- d) Shear load only

## Materials

### Material quality

Part	Material
Plastic sleeve	Polyamide 6
Screw	Carbon steel, galvanized $\geq 5 \mu\text{m}$

## Setting information

### Installation temperature

-10°C to +40°C

### In service temperature range

Hilti HMF universal plastic anchor may be applied in the temperature range given below.

### Temperature in base material

Temperature range	Base material temperature	Max. long term base material temperature	Max. short term base material temperature
Temperature range I	-40 °C to +80 °C	+50 °C	+80 °C

### Max short term base material temperature

Short-term elevated base material temperatures are those that occur over brief intervals, e.g. as a result of diurnal cycling.

### Max long term base material temperature

Long-term elevated base material temperatures are roughly constant over significant periods of time.

## Setting details

Anchor size		HMF 5x25	HMF 6x30	HMF 8x40	HMF 10x50	HMF 12x60	HMF 14x70
Screw type <sup>b)</sup>		CS 4 PH 4	CS 4,5 PH 4,5	CS 5 PH 5 HH 5	CS 7 PH 7 HH 7	HH 8	HH 10
Nominal diameter of drill bit	$d_o$ [mm]	5	6	8	10	12	14
Cutting diameter of drill bit	$d_{cut}$ [mm]	5,35	6,4	8,45	10,45	12,5	14,5
Depth of drill hole	$h_1 \geq$ [mm]	35	40	50	70	80	90
Nominal anchorage depth	$h_{nom}$ [mm]	25	30	40	50	60	70
Anchor length	$l_d$ [mm]	25	30	40	50	60	70
Diameter of clearance hole in the fixture	$d_f \leq$ [mm]	5,5	6,5	8,5	11	13	15
Length of the screw	[mm]	35	40	50	60	70	80
Drive configuration		Pz2	Pz2	Pz2/T30	T30	T30	T30
Hexhead diameter	[mm]	-	-	8	10	10	13
Max fixture thickness	$t_{fix}$ [mm]	5	5	5	5	5	5
Min. edge distance in concrete	$c_{min}$ [mm]	50	50	50	50	50	50

b) CS: Countersunk, PH: Pan head, HH hexagonal head; screws are specified by Hilti and can be ordered with the plastic body.

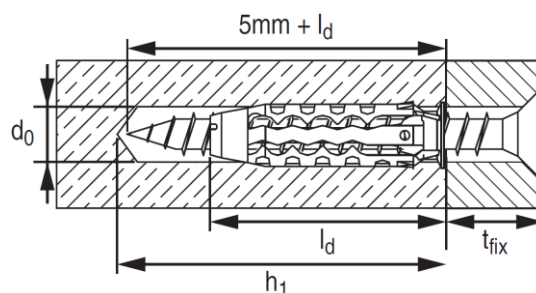

### Installation equipment

Anchor size	HMF	5x25	6x30	8x40	10x50	12x60	14x70
Rotary hammer					TE 2- TE16		
Other tools					Screwdriver		

### Setting instruction

\*For detailed information on installation see instruction for use given with the package of the product.

Setting instruction	
<b>1. Drill hole with drill bit</b> 	<b>2. Insert the anchor</b> 
<b>3. Drive screw into anchor</b> 	<b>4a. Drive screw into anchor in concrete</b> 
<b>4b. Drive screw into anchor in drywall</b> 	<b>4c. Drive screw into anchor in solid brick</b> 
<b>4d. Drive screw into anchor in hollow brick</b> 	

# GD 14 + GRS 12 Plastic anchors

## Economical plastic scaffolding anchor

### Anchor version



GD 14 (anchor body)  
GRS 12 (screw)  
(M14)

### Benefits

- Available in carbon steel and hot-dipped galvanized
- Integrated plastic and steel washer

### Base material



Concrete  
(non-cracked)

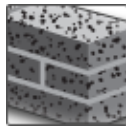

Solid brick

### Basic loading data

#### All data in this section applies to:

- Correct setting (See setting instruction)
- Load data are only valid for the specified screw
- No edge distance and spacing influence
- Minimum base material thickness

#### Design resistance <sup>a) b)</sup>

Anchor size		GD 14					
		GDS 12x90	GDS 12x120	GDS 12x160	GDS 12x190	GDS 12x230	GDS 12x350
Concrete C16/20 – C50/60	$N_{Rd}$ [kN]	4,2					
	$V_{Rd}$ [kN]	2,8	2,5	1,0	0,6	0,35	0,13
Solid clay brick Mz 12-2.0	$N_{Rd}$ [kN]	1,9					
	$V_{Rd}$ [kN]	1,0	1,0	1,0	0,6	0,35	0,13
Solid sand-lime brick KS 12-2.0	$N_{Rd}$ [kN]	1,3					
	$V_{Rd}$ [kN]	0,7	0,7	0,7	0,6	0,35	0,35

a) With partial safety factor  $\gamma = 1,8$  for concrete and  $\gamma = 2,5$  for masonry (acc. ETAG 020).

b) Shear load data are determined from the lower value of anchor load capacity in the base material and the serviceability load that ensures a maximum bending of the screw of 1/50 of its lever arm.

#### Recommended load <sup>a) b)</sup>

Anchor size		GD 14					
		GDS 12x90	GDS 12x120	GDS 12x160	GDS 12x190	GDS 12x230	GDS 12x350
Concrete C16/20 – C50/60	$N_{Rd}$ [kN]	2,8					
	$V_{Rd}$ [kN]	1,8	1,7	0,65	0,4	0,23	0,09
Solid clay brick Mz 12-2.0	$N_{Rd}$ [kN]	1,3					
	$V_{Rd}$ [kN]	0,65	0,65	0,65	0,4	0,23	0,09
Solid sand-lime brick KS 12-2.0	$N_{Rd}$ [kN]	0,85					
	$V_{Rd}$ [kN]	0,5	0,5	0,5	0,4	0,23	0,09

a) With partial safety factor  $\gamma = 1,8$  for concrete and  $\gamma = 2,5$  for masonry (acc. ETAG 020).

b) Shear load data are determined from the lower value of anchor load capacity in the base material and the serviceability load that ensures a maximum bending of the screw of 1/50 of its lever arm.

## Materials

### Material quality

Part	Material
Plastic sleeve	Polyamide

## Setting information

### Installation temperature

-10°C to +40°C

### Service temperature range

Hilti GD frame anchors may be applied in the temperature range given below.

Temperature range	Base material temperature	Max. long term base material temperature	Max. short term base material temperature
Temperature range	-40 °C to +80 °C	+50 °C	+80 °C

### Max short term base material temperature

Short-term elevated base material temperatures are those that occur over brief intervals, e.g. as a result of diurnal cycling.

### Max long term base material temperature

Long-term elevated base material temperatures are roughly constant over significant periods of time.

## Setting details

Anchor size	GD 14		
Drill hole diameter	$d_o$	[mm]	14
Cutting diameter of drill bit	$d_{cut} \leq$	[mm]	14,5
Depth of drilled hole to deepest point	$h_1 \geq$	[mm]	90
Overall plastic anchor embedment depth in base material	$h_{nom} \geq$	[mm]	70
Recommended length of screw in base material	$l_d$	[mm]	75

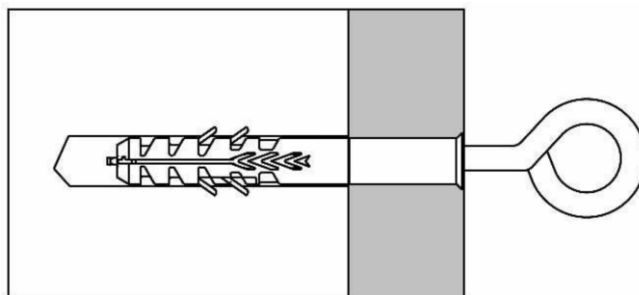

## Installation equipment

Anchor size	GD 14
Rotary hammer	TE 2- TE16
Other tools	-



## Setting instruction

\*For detailed information on installation see instruction for use given with the package of the product.

### Setting instruction for GD 14 + GRS 12

#### 1. Drilling

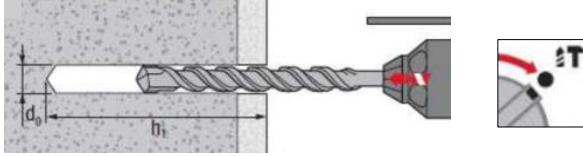

#### 2. Cleaning



#### 3. Inserting the anchor with hammer

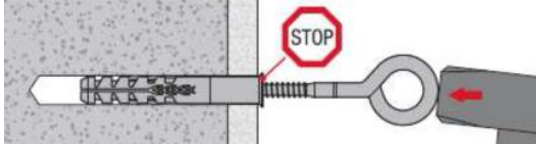

#### 4. Inserting the anchor with hand

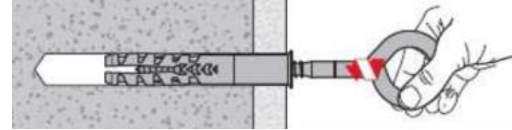

#### 5. Checking

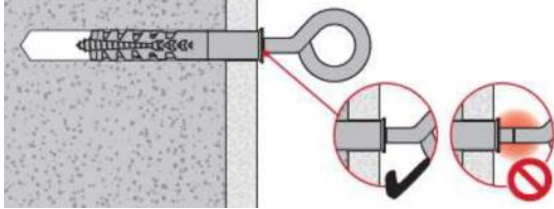

#### 6. Loading the anchor

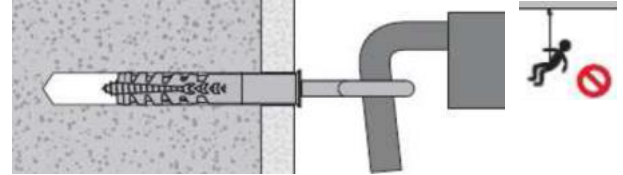

Use only for fixing scaffolds wall and floor applications. Not applicable for ceiling and façade applications.



Chemical anchors

Mechanical anchors

**Plastic/Light duty metal anchors**

Insulation anchors

# HFB Nail anchor

## Premium Fastener for Fire Protection Panels

Chemical anchors

Mechanical anchors

Plastic/Light duty metal anchors

Insulation anchors

### Anchor version

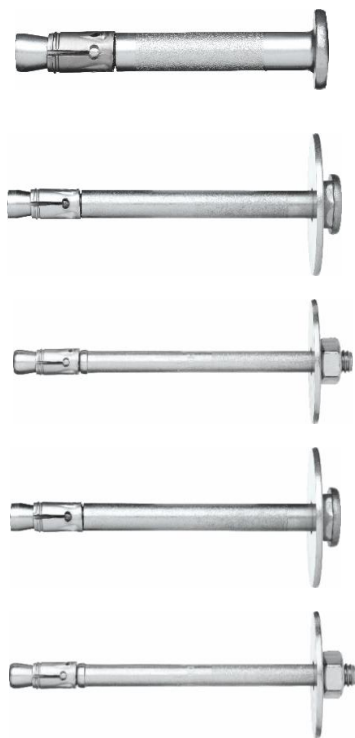

HFB (M6)

HFB-R (M6)

HFB-A-R (M6)

HFB-HCR (M6)

HFB-A-HCR (M6)

### Benefits

- Verified for ISO 834 (celluloid) curve, HCM curve, ZTV-ING part 5 curve and RWS fire curve.
- System tests with several market leading Boards
- Keeps its place under static, dynamic and seismic (C1) conditions thereby minimizing economical impact.
- Comes with a cordless electric power tool for drilling, setting and removal allowing the fastest (re-) installation time, ensuring that the service interruption is minimized.
- The anchor can easily be removed, even the "nail head" geometry"
- Pre-assembled washer
- Mesh clip for a quick and easy installation support when used with sprayed fire protection mortar

### Base material



Concrete (cracked)

### Load conditions



Static/  
quasi-static



Seismic  
C1



Fire  
resistance

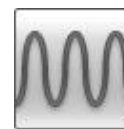

Fatigue/Dynamic

### Installation conditions

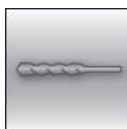

Hammer  
drilled holes

### Other information



European  
Technical  
Assessment



CE  
conformity

### Approvals / certificates

Description	Authority / Laboratory	No. / date of issue
European technical assessment <sup>a)</sup>	ZAG. Ljubljana	ETA-17/0168, 2019-04-10
Fire test report <sup>a)</sup>	ZAG. Ljubljana	ETA-17/0168, 2019-04-10
Fire test report (RWS/HCinc)	EFFECTIS France	EFR-18-J-002325
Seismic report	Fastening-technology	TA-1703, 2018-05-25
Fatigue	Hilti technical data	TA

<sup>a)</sup> All data given in this section according to ETA-17/0168, issue 2019-04-10.

## Static and quasi-static loading (for a single anchor)

### All data in this section applies to:

- Correct setting (See setting instruction)
- No edge distance and spacing influence
- **Steel** failure
- Minimum base material thickness
- Concrete C 20/25,  $f_{ck,cube} = 25 \text{ N/mm}^2$

### Effective anchorage depth for static

Anchor size			M6		
Eff. Anchorage depth	$h_{ef}$	[mm]	25	30	35 <sup>a)</sup>

### Characteristic resistance

Anchor size			M6		
Cracked concrete					
Load in all directions $F_{0Rk}$	HFB-R, HFB-HCR, HFB-A-HCR	[kN]	3,0	5,0	6,0
	HFB, HFB-A-R		3,0	4,5	6,0 <sup>a)</sup>

### Design resistance

Anchor size			M6		
Cracked concrete					
Load in all directions $F_{0Rd}$	HFB-R, HFB-HCR, HFB-A-HCR	[kN]	2,0	3,3	4,0
	HFB, HFB-A-R		2,0	3,0	4,0 <sup>a)</sup>

### Recommended resistance

Anchor size			M6		
Cracked concrete					
Load in all directions $F_{0Rec}$	HFB-R, HFB-HCR, HFB-A-HCR	[kN]	1,4	2,4	2,8
	HFB, HFB-A-R		1,4	2,1	2,8 <sup>a)</sup>

a) Not applicable to HFB (CS), since it is not tested for  $h_{ef}=35$ .

b) With overall partial safety factor for action  $\gamma = 1,4$ , The partial safety factors for action depend on the type of loading and shall be taken from national regulations.

## Seismic loading (for a single anchor)

### All data in this section applies to:

- Correct setting (See setting instruction)
- No edge distance and spacing influence
- Steel failure
- Minimum base material thickness
- Concrete C 20/25,  $f_{ck,cube} = 25 \text{ N/mm}^2$
- All data given in this section is according to TA-1703, issue 2018-05-25

### Effective anchorage depth for seismic C1

Anchor size	M6		
Effective Anchorage depth $h_{ef}$ [mm]	25	30	35

### Characteristic resistance in case of seismic performance C1

Anchor size	M6				
Cracked concrete					
Tension $N_{Rk}$	HFB-R	[kN]	3,0	4,0	4,0
	HFB-A-R		3,0	4,0	4,0
Shear $V_{Rk}$	HFB-R	[kN]	-	3,5	3,5
	HFB-A-R		-	-	-

### Design resistance in case of seismic performance C1

Anchor size	M6				
Cracked concrete					
Tension $N_{Rd}$	HFB-R	[kN]	2,0	2,6	2,6
	HFB-A-R		2,0	2,6	2,6
Shear $V_{Rd}$	HFB-R	[kN]	-	2,3	2,3
	HFB-A-R		-	-	-

### Recommended resistance in case of seismic performance C1

Anchor size	M6				
Cracked concrete					
Tension $N_{Rec}$	HFB-R	[kN]	1,4	1,9	1,9
	HFB-A-R		1,4	1,9	1,9
Shear $V_{Rec}$	HFB-R	[kN]	-	1,6	1,6
	HFB-A-R		-	-	-

- a) With overall partial safety factor for action  $\gamma = 1,4$ , The partial safety factors for action depend on the type of loading and shall be taken from national regulations,

## Fire resistance

### All data in this section applies to:

- Correct setting (See setting instruction)
- No edge distance and spacing influence
- Steel failure
- Minimum base material thickness
- Concrete C 20/25 to C50/60
- Partial safety factor for resistance under fire exposure  $\gamma_{M,fi} = 1,0$  (in absence of other national regulations)

### Effective anchorage depth

Anchor size	M6		
Eff, Anchorage depth $h_{ef}$ [mm]	25	30	35 <sup>a)</sup>

a) Not applicable to HFB (CS), since it is not tested for  $h_{ef}=35$ .

### Characteristic resistance

Anchor size	M6				
<b>Fire exposure R30</b>					
Load in all directions $F_{0Rk}$	HFB	[kN]	0,5	0,9	- a)
	HFB-R, HFB-HCR	[kN]	0,5	0,9	1,2
	HFB-A-R, HFB-A-HCR	[kN]	0,5	0,9	1,0
<b>Fire exposure R60</b>					
Load in all directions $F_{0Rk}$	HFB	[kN]	0,5	0,6	- a)
	HFB-R, HFB-HCR	[kN]	0,5	0,9	1,2
	HFB-A-R, HFB-A-HCR	[kN]	0,5	0,6	0,6
<b>Fire exposure R90</b>					
Load in all directions $F_{0Rk}$	HFB	[kN]	0,4	0,4	- a)
	HFB-R, HFB-HCR	[kN]	0,5	0,9	1,2
	HFB-A-R, HFB-A-HCR	[kN]	0,3	0,3	0,3
<b>Fire exposure R120</b>					
Load in all directions $F_{0Rk}$	HFB	[kN]	0,3	0,3	- a)
	HFB-R, HFB-HCR	[kN]	0,2	0,7	1,0
	HFB-A-R, HFB-A-HCR	[kN]	0,1	0,1	0,1

### Design resistance

Anchor size	M6				
<b>Fire exposure R30</b>					
Load in all directions $F_{0Rd}$	HFB	[kN]	0,5	0,9	- a)
	HFB-R, HFB-HCR	[kN]	0,5	0,9	1,2
	HFB-A-R, HFB-A-HCR	[kN]	0,5	0,9	1,0
<b>Fire exposure R60</b>					
Load in all directions $F_{0Rd}$	HFB	[kN]	0,5	0,6	- a)
	HFB-R, HFB-HCR	[kN]	0,5	0,9	1,2
	HFB-A-R, HFB-A-HCR	[kN]	0,5	0,6	0,6
<b>Fire exposure R90</b>					
Load in all directions $F_{0Rd}$	HFB	[kN]	0,4	0,4	- a)
	HFB-R, HFB-HCR	[kN]	0,5	0,9	1,2
	HFB-A-R, HFB-A-HCR	[kN]	0,3	0,3	0,3
<b>Fire exposure R120</b>					
Load in all directions $F_{0Rd}$	HFB	[kN]	0,3	0,3	- a)
	HFB-R, HFB-HCR	[kN]	0,2	0,7	1,0
	HFB-A-R, HFB-A-HCR	[kN]	0,1	0,1	0,1

## Materials

### Material quality

Part		Material
<b>Metal parts made of carbon steel</b>		
Anchor Bolt	HFB	Carbon steel, galvanized, coated, rupture elongation ( $l_0 = 5d$ ) > 8%
Expansion Sleeve	HFB	Stainless steel A4
<b>Metal parts made of stainless steel</b>		
Anchor Bolt	HFB-R, HFB-A-R	Stainless steel A4, coated, rupture elongation ( $l_0 = 5d$ ) > 8%
Expansion Sleeve	HFB-R, HFB-A-R	Stainless steel A4
Washer	HFB-R, HFB-A-R	Stainless steel A4
Hexagon/Special nut	HFB-R, HFB-A-R	Stainless steel A4
<b>Metal parts made of high corrosion resistant steel</b>		
Anchor Bolt	HFB-HCR HFB-A-HCR	High corrosion resistance steel, coated, rupture elongation ( $l_0 = 5d$ ) > 8%
Expansion Sleeve	HFB-HCR HFB-A-HCR	High corrosion resistance steel
Washer	HFB-HCR HFB-A-HCR	High corrosion resistance steel
Hexagon/Special nut	HFB-HCR HFB-A-HCR	High corrosion resistance steel

### Anchor dimensions

Anchor		HFB	HFB-R and HFB-HCR	HFB-A-R and HFB-A-HCR
Maximum length of anchor	$l_{max} \leq$ [mm]	150		
Anchor diameter	$d_1$ [mm]	5,9	5,2	
Shaft diameter at the cone	$d_R$ [mm]	4,2		
Diameter of head	$d_H \leq$ [mm]	12,2	-	
Length of expansion sleeve	$l_s$ [mm]	10,1		
Diameter of washer	$d_w \leq$ [mm]	-	30	
Thickness of washer	$h_w \leq$ [mm]	-	1,5	

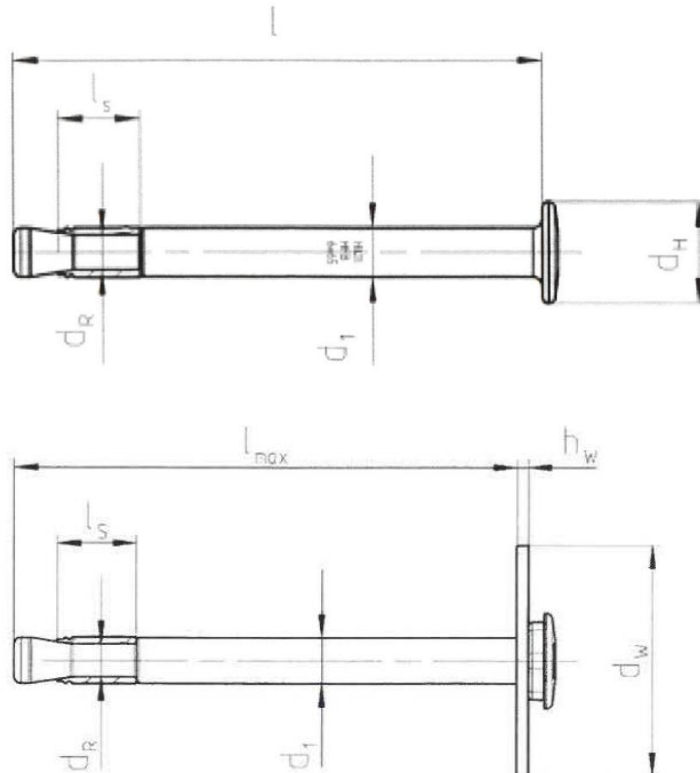



## Setting information

### Setting details

Anchor			HFB, HFB-R, HFB-A-R, HFB-HCR and HFB-A-HCR		
Nominal diameter of drill bit	$d_o$	[mm]	6		
Cutting diameter of drill bit	$d_{cut} \leq$	[mm]	6,40		
Maximum diameter of clearance hole in the fixture	$d_f$	[mm]	7		
Nominal embedment depth	$h_{nom}$	[mm]	30	35	40 <sup>a)</sup>
Effective embedment depth	$h_{ef}$	[mm]	25	30	35 <sup>a)</sup>
Drill hole depth	$h_1 \geq$	[mm]	34	39	44 <sup>a)</sup>

a) Not applicable to HFB (CS), since it is not tested for  $h_{ef}=35$ .

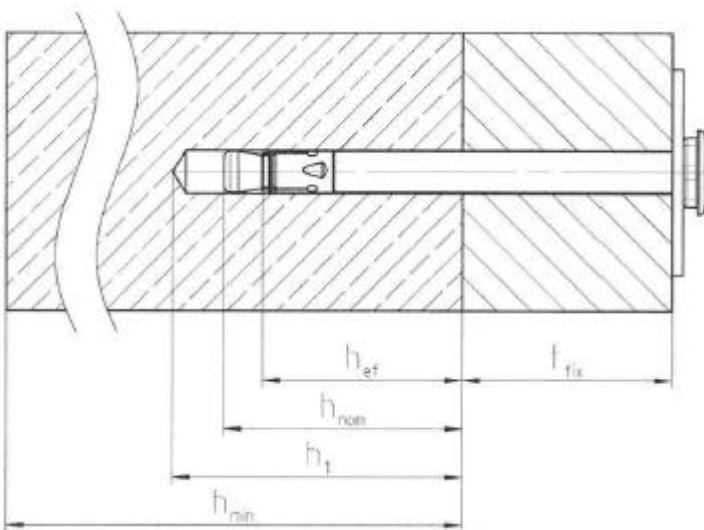

### Setting parameters

Anchor Size			HFB, HFB-R, HFB-A-R, HFB-HCR and HFB-A-HCR		
Effective anchorage depth	$h_{ef}$	[mm]	25	30	35 <sup>a)</sup>
Minimum base material thickness	$h_{min}$	[mm]	80	80	80 <sup>a)</sup>
Minimum spacing	$s_{min}$	[mm]	50	50	50 <sup>a)</sup>
	for $c \geq$	[mm]	50	50	50 <sup>a)</sup>
Minimum edge distance	$c_{min}$	[mm]	40	40	40 <sup>a)</sup>
	for $s \geq$	[mm]	75	80	80 <sup>a)</sup>

a) Not applicable to HFB (CS), since it is not tested for  $h_{ef}=35$ .

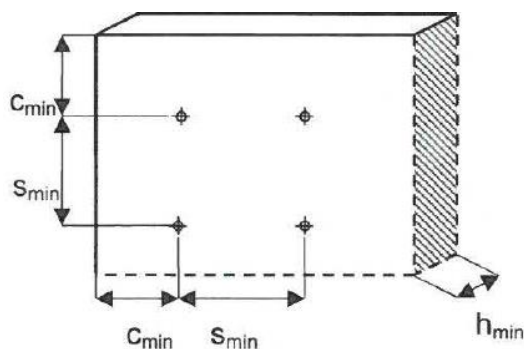

## Installation equipment

Anchor size	HFB	HFB-R	HFB-A-R	HFB-HCR	HFB-A-HCR
Rotary hammer	TE-4 (-A) – TE-6 (-A)				
Setting tool	TE-C-HFB-ST				
Setting tool pneumatic	P-HFB-ST				
Setting tube	D-HFB-ST				
Socket wrench	-	-	SI-HFB-RS	-	SI-HFB-RS
Mesh clip	-	HFB-CM 20	HFB-CM 20	-	-

## Applications



***Fastening of pre-fabricated fire protection boards***



***Fastening of light wire mesh reinforcement for fire protection mortar***

## Setting instructions

\*For detailed information on installation see instruction for use given with the package of the product

### Setting instruction for HFB-R, HFB-A-R, HFB-HCR and HFB-A-HCR

#### Hammer drilling

##### 1. Drill the hole

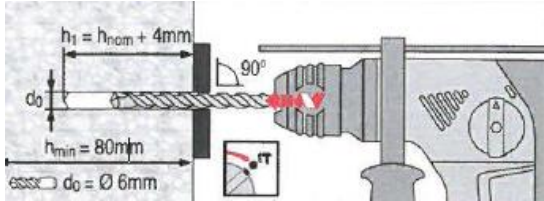

##### 2. Clean the hole

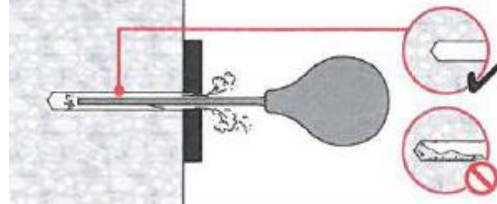

##### 3a. Insert the anchor with hammer

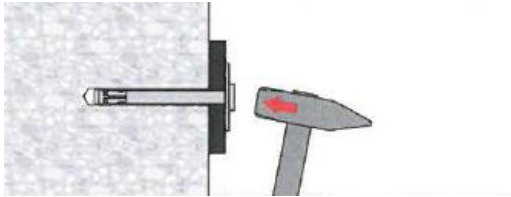

##### 3b. Insert the anchor with setting tool TE-C-HFB-ST

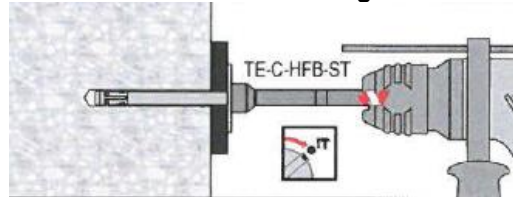

##### 3c. Insert the anchor with setting tool D-HFB-ST

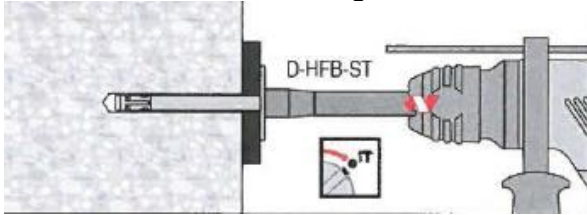

##### 3d. Insert the anchor with setting tool P-HFB-ST

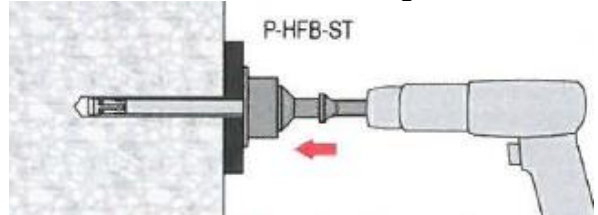

##### 4. Check the anchor

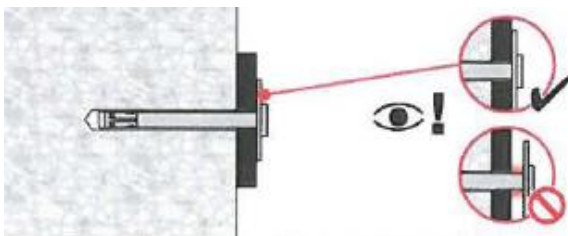

# DBZ Light duty metal anchors

## Economical wedge anchor

### Anchor version



DBZ  
(M6)

### Benefits

- Well proven
- Simple installation
- Small drill bit diameter
- Suitable for cracked and non-cracked concrete C20/25 to C50/60
- Redundant fastening only, e.g. suspended ceilings

### Base material

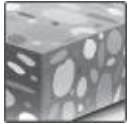

Concrete  
(non-cracked)

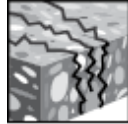

Concrete  
(cracked)

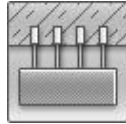

Redundant  
fastening

### Load conditions

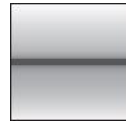

Static /  
quasi-static



Fire  
resistance

### Other information



European  
Technical  
Assessment



CE conformity

### Approvals / certificates

Description	Authority / Laboratory	No. / date of issue
European Technical Assessment <sup>a)</sup>	DIBt, Berlin	ETA-06/0179 / 2016-09-15
Fire test report	DIBt, Berlin	ETA-06/0179 / 2016-09-15
Assessment fire report	warringtonfire	WF364181 / 2016-05-03

a) All data given in this section according ETA-06/0179, issue 2016-09-15. The anchor is to be used only for redundant fastening for non-structural applications.

### Basic loading data

#### All data in this section applies to:

- Correct setting (See setting instruction)
- No edge distance and spacing influence
- Concrete C20/25 to C50/60
- Anchors in redundant fastening

#### Characteristic resistance

Anchor size	DBZ 6 / 4,5	DBZ 6 / 35
Resistance, all load directions $F_{Rk}$ [kN]	5,0	

### Design resistance

Anchor size			DBZ 6 / 4,5	DBZ 6 / 35
Resistance, all load directions	$F_{Rd}$	[kN]	3,3	

### Recommended loads <sup>a)</sup>

Anchor size			DBZ 6 / 4,5	DBZ 6 / 35
Resistance, all load directions	$F_{Rec}$	[kN]	2,4	

a) With overall partial safety factor for action  $\gamma = 1,4$ . The partial safety factors for action depend on the type of loading and shall be taken from national regulations.

The definition of redundant fastening according to Member States is given in the ETAG 001 Part six, Annex 1. In Absence of a definition by a Member States the following default values may be taken.

Minimum number of fixing points	Minimum number of anchors per fixing point	Maximum design load of action $N_{sd}$ per fixing point <sup>a)</sup>
3	1	2
4	1	3

a) The value for maximum design load of actions per fastening point  $N_{sd}$  is valid in general that means all fastening points are considered in the design of the redundant structural system. The value  $N_{sd}$  may be increased if the failure of one (=most unfavourable) fixing point is taken into account in the design (serviceability and ultimate limit state) of the structural system e.g. suspended ceiling.

### Materials

#### Mechanical properties

Anchor size			DBZ 6 / 4,5	DBZ 6 / 35
Nominal tensile strength	$f_{uk}$	[N/mm <sup>2</sup> ]	390	390
Yield strength	$f_{yk}$	[N/mm <sup>2</sup> ]	310	310
Stressed cross-section	$A_s$	[mm <sup>2</sup> ]	26	26
Char. bending resistance	$M^0_{Rk,s}$	[Nm]	5,0	5,0

#### Material quality

Part	Material
Anchor shank (1)	Cold-formed steel, galvanized $\geq 5\mu\text{m}$
Expansion pin (2)	Cold-formed steel, galvanized $\geq 5\mu\text{m}$

#### Anchor dimension

Anchor size			DBZ 6 / 4,5	DBZ 6 / 35
Height anchor head	$l_1$	[mm]	2,5	2,5
Max. distance	$d_1$	[mm]	6,4	6,4
Length of anchor shaft	$l_2$	[mm]	37,5	68

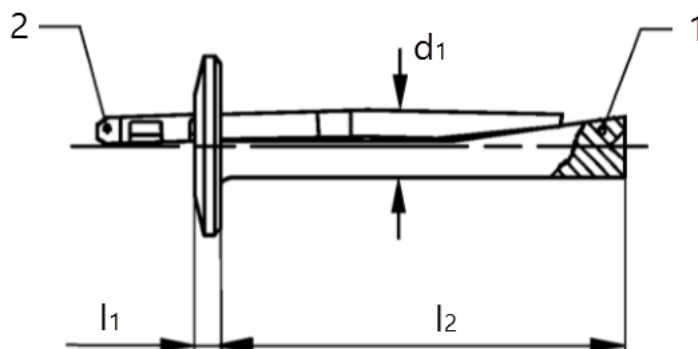



## Setting information

### Setting details

Anchor size		DBZ 6 / 4,5	DBZ 6 / 35	
Thickness of fixture	$t_{fix}$ [mm]	$\leq 4,5$	$20 \leq t_{fix} \leq 35$	$5 \leq t_{fix} \leq 20$
Depth of drill hole	$h_1 \geq$ [mm]	40	55	70
Cutting diameter of drill bit	$d_{cut} \leq$ [mm]	6,4		
Nominal diameter of drill bit	$d_0$ [mm]	6		
Clearance hole diameter	$d_r \leq$ [mm]	7		

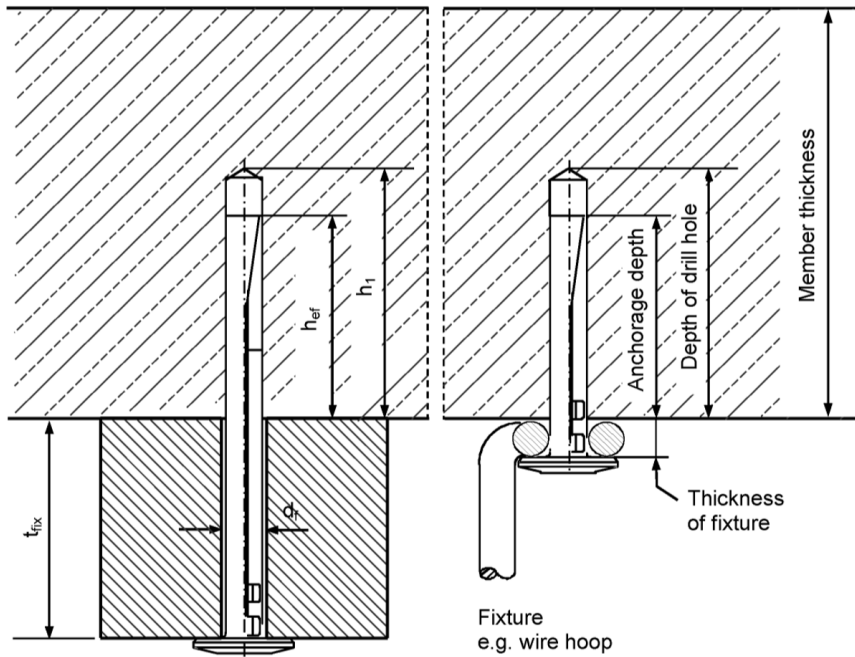

### Installation equipment

Anchor size	DBZ 6 / 4,5	DBZ 6 / 35
Rotary hammer	TE 2 -TE 7	
Other tools	Hammer, blow out pump	

### Setting parameters

Anchor size		DBZ 6 / 4,5	DBZ 6 / 35	
Thickness of fixture	$t_{fix}$ [mm]	$\leq 4,5$	$20 \leq t_{fix} \leq 35$	$5 \leq t_{fix} \leq 20$
Minimum member thickness	$h_{min} \geq$ [mm]	80	100	
Effective anchorage length	$h_{ef} \geq$ [mm]	32		
Spacing	$s_{min} = s_{cr}$ [mm]	200		
Edge distance	$c_{min} = c_{cr}$ [mm]	150		

- a) The critical spacing (critical edge distance) shall be kept. Smaller spacing (edge distance) than critical spacing (critical edge distance) are not covered by the design method.

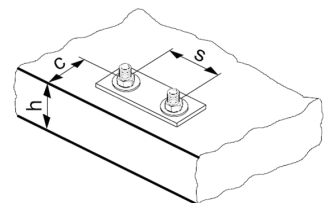

### Setting instruction

\*For detailed information on installation see instruction for use given with the package of the product.

Setting instructions		
<p><b>1</b> Drill hole with drill bit</p>	<p><b>2</b> Blow out dust completely</p>	<p><b>3</b> Insert anchor with fixture</p>
<p><b>4</b> Hammer down the expansion pin</p>	<p><b>5a</b> Check if the pin is completely flattened</p>	<p><b>5b</b> Max. exceedance of 2mm can be accepted</p>
<p><b>6</b> In case the pin exceedance is larger than 2mm replace the used drill bit with a new drill bit</p>		



# HK Light duty metal anchors

## Everyday standard ceiling anchor

### Anchor version



HK  
(M6-M8)



HK I  
(M6-M8)



HK L  
(M6-M8)

### Benefits

- Well proven
- Small drill bit diameter
- For fixing in cracked concrete, redundant fastening only, e.g. suspended ceilings

### Base material



Concrete  
(non-cracked)



Tensile zone  
(redundant  
fastening)

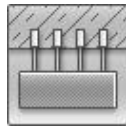

Redundant  
fastening

### Load conditions



Fire  
resistance

### Other information



European  
Technical  
Approval



CE  
conformity

### Approvals / certificates

Description	Authority / Laboratory	No. / date of issue
European technical assesment <sup>a)</sup>	DIBt, Berlin	ETA-04/0043, 2018-04-25
Fire test report	DIBt, Berlin	ETA-04/0043, 2018-04-25
Assessment fire report	warringtonfire	WF 327804/A / 2013-07-10

a) All data given in this section for HK Ceiling anchor according ETA-04/0043, issue 2018-04-25. The anchor is to be used only for multiple use for non-structural applications.

### Basic loading data (for a single anchor)

#### All data in this section applies to:

- Correct setting (See setting instruction)
- No edge distance and spacing influence
- Concrete C20/25 to C50/60
- Non-cracked concrete:  $f_{cc} \geq 20 \text{ N/mm}^2$
- Anchors in multiple use

### Characteristic resistance

Anchor size (Carbon steel)	HK6	HK6 L	HK8 I
Resistance $F_{Rk}^{a)}$ [kN]	2,0	5,0	5,0
Anchor size (Stainless steel, HCR)	HK6 -R / -HCR	HK6 L -R / -HCR	HK8 I -R / -HCR
Resistance $F_{Rk}^{a)}$ [kN]	1,5	3,0	5,0

a) For all load directions (tension, shear and combined tension and shear loads)

### Design resistance

Anchor size (Carbon steel)	HK6	HK6 L	HK8 I
Resistance $F_{Rd}^{a)}$ [kN]	1,3	2,4	2,4
Anchor size (Stainless steel, HCR)	HK6 -R / -HCR	HK6 L -R / -HCR	HK8 I -R / -HCR
Resistance $F_{Rd}^{a)}$ [kN]	0,7	1,4	2,8

a) For all load directions (tension, shear and combined tension and shear loads)

### Recommended loads<sup>b)</sup>

Anchor size (Carbon steel)	HK6	HK6 L	HK8 I
Resistance $F_{Rec}^{a)}$ [kN]	0,9	1,7	1,7
Anchor size (Stainless steel, HCR)	HK6 -R / -HCR	HK6 L -R / -HCR	HK8 I -R / -HCR
Resistance $F_{Rec}^{a)}$ [kN]	0,5	1,0	2,0

a) For all load directions (tension, shear and combined tension and shear loads)

b) With overall partial safety factor for action  $\gamma = 1,4$ . The partial safety factors for action depend on the type of loading and shall be taken from national regulations.

### Special case: Groups of $n=2$ and /or $n=4$ anchors with small spacing:

The basic loading data for a single anchor is valid for one fixing point.

Fixing point can be:

- Single anchors
- Groups of 2 anchors  
With  $s_1 \geq 60\text{mm}$
- Groups of 4 anchors  
With  $s_1 \geq 100\text{mm}$  and  $s_2 \geq 100$

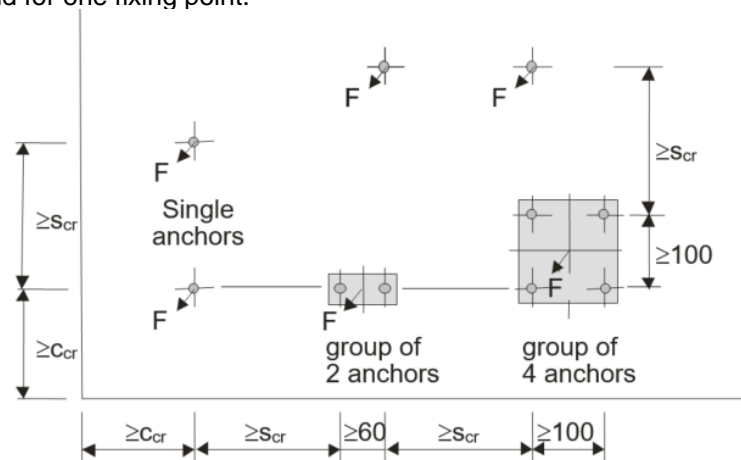

### Requirements for multiple use

The definition of multiple use according to Member State is given in the ETAG 001 Part six, Annex 1. In absence of a definition by a Member State the following default values may be taken.

Minimum number of fixing points	Minimum number of anchors per fixing point	Maximum design load of action $N_{Sd}$ per fixing point <sup>a)</sup>
3	1	2kN
4	1	3kN

a) The value for maximum design load of actions per fastening point  $N_{Sd}$  is valid in general that means all fastening points are considered in the design of the redundant structural system. The value  $N_{Sd}$  may be increased if the failure of one (=most unfavourable) fixing point is taken into account in the design (serviceability and ultimate limit state) of the structural system e.g. suspended ceiling.

## Materials

### Mechanical properties

Anchor size (carbon steel).o		HK6	HK6-L	HK8-I
Characteristic bending resistance	$M^0_{Rk,s}$ [Nm]	3,6	7,7	18
Anchor size (Stainless steel, HCR)		HK6 -R / -HCR	HK6 L -R / -HCR	HK8 I -R / -HCR
Characteristic bending resistance	$M^0_{Rk,s}$ [Nm]	4,0	8,4	20,6

### Material quality

Part	Marking	Material
HK6 HK6 L HK8 I	K6 K6L K8	Galvanized steel $\geq 5\mu\text{m}$
HK6-R HK6 L-R HK8 I-R	K6E K6LE K8E	Stainless steel 1.4401 or 1.4404
	K6X K6LX K8X	Stainless steel 1.4571
HK6-HCR HK6 L-HCR HK8 I-HCR	K6C K6LC K8C	High corrosion resistant steel 1.4529 or 1.4565

### Anchor dimension

Anchor size		HK6				
		HK6 M6/t <sub>fix</sub>		HK6 M8/t <sub>fix</sub>		
Thread size		External thread M6		External thread M8		
Setting tool		HSM 6/t <sub>fix</sub>		HSM 8/t <sub>fix</sub>		
Length of thread	l <sub>th</sub> [mm]	5 ≤ l <sub>th</sub> ≤ 50				
Max. thickness of fixture	t <sub>fix</sub> [mm]	t <sub>fix</sub> = l <sub>p</sub> - 7				
Anchor size		HK6 L				
		HK M6/4 L	HK6 M6/t <sub>fix</sub> L	HK6 M8/t <sub>fix</sub> L	HK6-I M6 L	HK6-I M8 L
Thread size		External thread M6	External thread M6	External thread M8	Internal thread M6	Internal thread M6
Setting tool		HSM 6/4	HSM 6/t <sub>fix</sub>	HSM 8/t <sub>fix</sub>	HSM I M6	HSM I M8
Length of thread	l <sub>th</sub> [mm]	≥5	≥5	≥5	-	-
Max. thickness of fixture	t <sub>fix</sub> [mm]	4	t <sub>fix</sub> ≤ 300	t <sub>fix</sub> ≤ 300	-	-
Available thread length	[mm]	-	-	-	6 to 12	8 to 12
Anchor size		HK8 I				
		HK8 I M8	HK8 I M10	HK8 I M12	HK8 I M8/M10	
Thread size		Internal thread M8	Internal thread M10	Internal thread M12	Internal thread M8 / M10	
Setting tool		HSM 8 I M8	HSM 8 I M10	HSM 8 I M12	HSM 8 I M8	
Available thread length	[mm]	8 to 10	10 to 15	12 to 15	<b>M8:</b> 8 to 10 <b>M10:</b> 10	

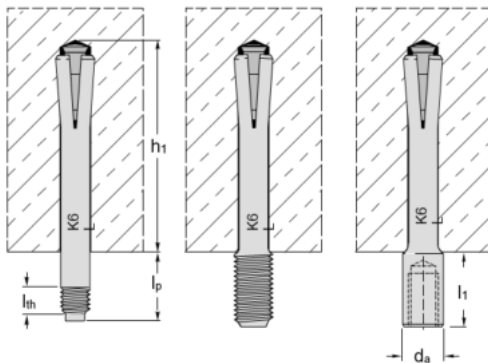

## Setting

### Setting details

Anchor size		HK6				
		HK6 M6/t <sub>fix</sub>		HK6 M8/t <sub>fix</sub>		
Depth of drill hole <sup>a)</sup>	$h_1$	32				
Nominal diameter of drill bit	$d_0$	6				
Clearance hole	$d_f \leq$	7		9		
Max. torque moment	$T_{max}$	5				
Anchor size		HK6 L				
		HK M6/4 L	HK6 M6/t <sub>fix</sub> L	HK6 M8/t <sub>fix</sub> L	HK6-I M6	HK6-I M8 L
Depth of drill hole <sup>a)</sup>	$h_1$	42				
Nominal diameter of drill bit	$d_0$	6				
Clearance hole	$d_f \leq$	7	7	9	9	12
Max. torque moment	$T_{max}$	5				
Anchor size		HK8 I				
		HK8 I M8	HK8 I M10	HK8 I M12	HK8 I M8/M10	
Depth of drill hole <sup>a)</sup>		43				
Setting tool		12	14	16	14	
Available thread length	[mm]	10				

a) Use stop drill bit to ensure correct depth of bore hole.

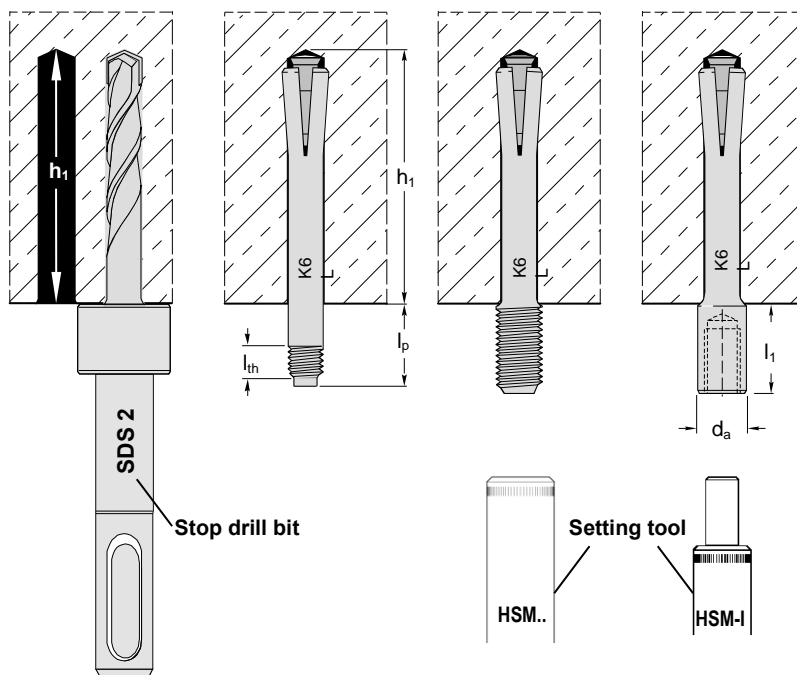

## Installation equipment

Anchor size	HK6	HK6-L	HK8-I
Rotary hammer	TE 2 – TE 16		
Stop drill bit <sup>a)</sup>	TE-C/SDS 1	TE-C / SDS 2	TE – C/SDS 3
Setting tool	HSM ... / HSM I ...		HSM 8 .. /HSM 8 I..
Other tools	Blow out pump		

a) In case of through setting choose stop drill bit with appropriate length.

## Setting parameters <sup>a)</sup>

Anchor size	HK6	HK6-L	HK8-I
Minimum member thickness $h_{min} \geq$ [mm]	80		
Effective anchorage depth $h_{ef}$ [mm]	26	36	36
Critical spacing $s_{cr}$ [mm]	200		
Critical edge distance $c_{cr}$ [mm]	150		

a) The critical spacing (critical edge distance) shall be kept. Smaller spacing (edge distance) than critical spacing (critical edge distance) are not covered by the design method.

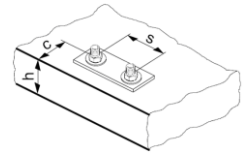

## Setting instruction

\*For detailed information on installation see instruction for use given with the package of the product.

Setting instruction	
External thread	
<b>Setting of HK with hand setting tool</b> 	<b>Setting of HK with machine setting tool</b> 
Internal thread	
<b>Setting of HK...-I with hand setting tool</b> 	<b>Setting of HK...-I with machine setting tool</b> 



Chemical anchors

Mechanical anchors

**Plastic/Light duty metal anchors**

Insulation anchors

# HLC Light duty metal anchors







## Economical sleeve anchor



Chemical anchors

Mechanical anchors

Plastic/Light duty metal anchors

Insulation anchors

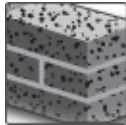
Anchor version			Benefits
	HLC (M5-M16)	Hex head nut with pressed-on washer	- Various head shapes and fastenings thickness
	HLC-H (M5-M16)	Bolt version with washer	
	HLC-L (M5-M16)	Torx round head	
	HLC-SK (M5-M16)	Torx counter sunk head	
	HLC-EC (M5-M16)	Loop-hanger head, eyebold closed	
	HLC-EO (M5-M16)	Loop-hanger head, eyebold open	
	HLC-T (M5-M16)	Ceiling hanger	

Base material	Load condition
  <p>Concrete (non-cracked)      Solid brick</p>	 <p>Fire resistance</p>

Approvals/certificates		
Description	Authority/Laboratory	No./date of issue
Fire test report	IBMB, Braunschweig	PB 3093/517/07-CM / 2007-09-10
Assessment report (fire)	Warringtonfire	WF 327804/A / 2013-07-10



### Basic loading data (for a single anchor)

All data in this section is Hilti technical data and applies to:

- Correct setting (See setting instruction)
- No edge distance and spacing influence
- Concrete as specified in the table
- *Steel* failure
- Minimum base material thickness
- Concrete C 20/25,  $f_{ck,cube} = 25 \text{ N/mm}^2$

#### Effective anchorage depth

Anchor size	M5	M6	M8	M10	M12	M16
Effective anchorage depth $h_{ef}$ [mm]	16	26	31	33	41	41

#### Characteristic resistance

Anchor size	M5	M6	M8	M10	M12	M16
Tension $N_{Rk}$ [kN]	2,1	3,5	4,5	7,2	10,0	13,2
Shear $V_{Rk}$ [kN]	3,2	7,0	8,8	14,4	20,0	20,0

#### Design resistance

Anchor size	M5	M6	M8	M10	M12	M16
Tension $N_{Rd}$ [kN]	1,2	2,0	2,5	4,0	5,6	7,4
Shear $V_{Rd}$ [kN]	1,8	3,9	4,9	8,0	11,1	11,1

#### Recommended loads<sup>a)</sup>

Anchor size	M5	M6	M8	M10	M12	M16
Tension $N_{Rec}$ [kN]	0,8	1,4	1,8	2,9	4,0	5,3
Shear $V_{Rec}$ [kN]	1,3	2,8	3,5	5,7	7,9	7,9

a) With overall partial safety factor for action  $\gamma = 1,4$ . The partial safety factors for action depend on the type of loading and shall be taken from national regulations.

### Materials

#### Material quality

Part	Material
Anchor	HLC HLC-EC HLC-EO HLC-H HLC-L HLC-SK HLC-T
	Carbon steel tensile strength 500 MPa galvanized to min. 5 $\mu\text{m}$
	Steel Bolt Strength 8.8, galvanized to min 5 $\mu\text{m}$

### Anchor dimensions

Anchor version	Thread size	$h_{ef}$ [mm]	$d$ [mm]	$l$ [mm]	$l_c$ [mm]	$t_{fix}$ [mm]		
HLC, HLC-H, HLC-EC/EO carbon steel anchors	6,5 x 25/5	16	M5	30	25	5		
	6,5 x 40/20			45	40	20		
	6,5 x 60/40			65	60	40		
	8 x 40/10	26	M6	46	40	10		
	8 x 55/25			61	55	20		
	8 x 70/40			76	70	40		
	8 x 85/55			91	85	55		
	10 x 40/5	31	M8	48	40	5		
	10 x 50/15			58	50	15		
	10 x 60/25			68	60	25		
	10 x 80/45			88	80	45		
	10 x 100/65	33	M10	108	100	65		
	12 x 55/15			65	55	15		
	12 x 75/35			85	75	35		
	12 x 100/60	41	M12	110	100	60		
	16 x 60/10			72	60	10		
	16 x 100/50			112	100	60		
	16 x 140/90	41	M16	152	140	95		
	20 x 80/25			95	80	25		
	20 x 115/60			130	115	60		
20 x 150/95	41	M16	165	150	95			
HLC-SK carbon steel anchors			6,5 x 45/20	16	M5	45	-	20
			6,5 x 65/40			65		40
	6,5 x 85/60	85	60					
	8 x 60/25	26	M6	60	25			
8 x 75/40	75			40				
8 x 90/55	90			55				
10 x 45/5	31	M8	45	-	5			
10 x 85/45			85		45			
10 x 105/65			105		65			
10 x 130/95			130		95			
12 x 55/15	33	M10	80	-	35			

HLC, HLC-H, HLC-EC/EO, HLC-L

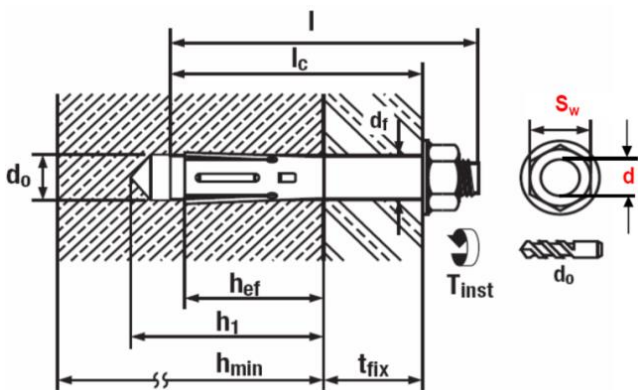

HLC-SK

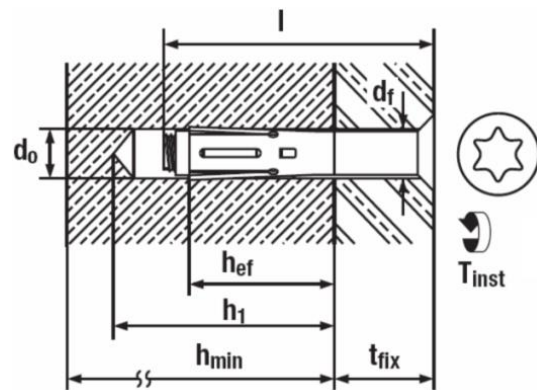

## Setting information

### Setting details HLC

		M5	M6	M8	M10	M12	M16
Nominal diameter of drill bit	$d_0$ [mm]	6,5	8	10	12	16	20
Cutting diameter of drill bit	$d_{cut} \leq$ [mm]	6,4	8,45	10,45	12,5	16,5	20,55
Depth of drill hole	$h_1 \geq$ [mm]	30	40	50	65	75	85
Width across nut flats	HLC SW [mm]	8	10	13	15	19	24
	HLC-H SW [mm]				17		
	HLS-SK Driver	PZ 3	T 30	T 40	T 40	-	-
Diameter of clearance hole in the fixture	$d_f \leq$ [mm]	7	10	12	14	18	21
Effective anchorage depth	$h_{ef}$ [mm]	16	26	31	33	41	41
Max. torque moment concrete	$T_{inst}$ [Nm]	5	8	25	40	50	80
Max. torque moment masonry	$T_{inst}$ [Nm]	2,5	4	13	20	25	-

### Installation equipment

Anchor size	M5	M6	M8	M10	M12
Rotary hammer for setting	TE 2 – TE 16				
Other tools	hammer, torque wrench, blow up pump				

### Setting parameters

Anchor size	M6	M8	M10	M10	M12	M16	
Minimum base material thickness	$h_{min}$ [mm]	60	70	80	100	100	120
Critical spacing for splitting failure and concrete cone failure	$s_{cr}$ [mm]	60	100	120	130	160	160
Critical edge distance for splitting failure and concrete cone failure	$c_{cr}$ [mm]	30	50	60	65	80	80

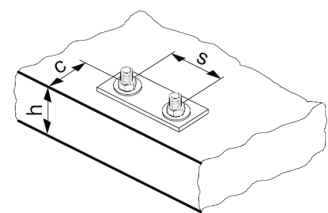

## Setting instruction

\*For detailed information on installation see instruction for use given with the package of the product.

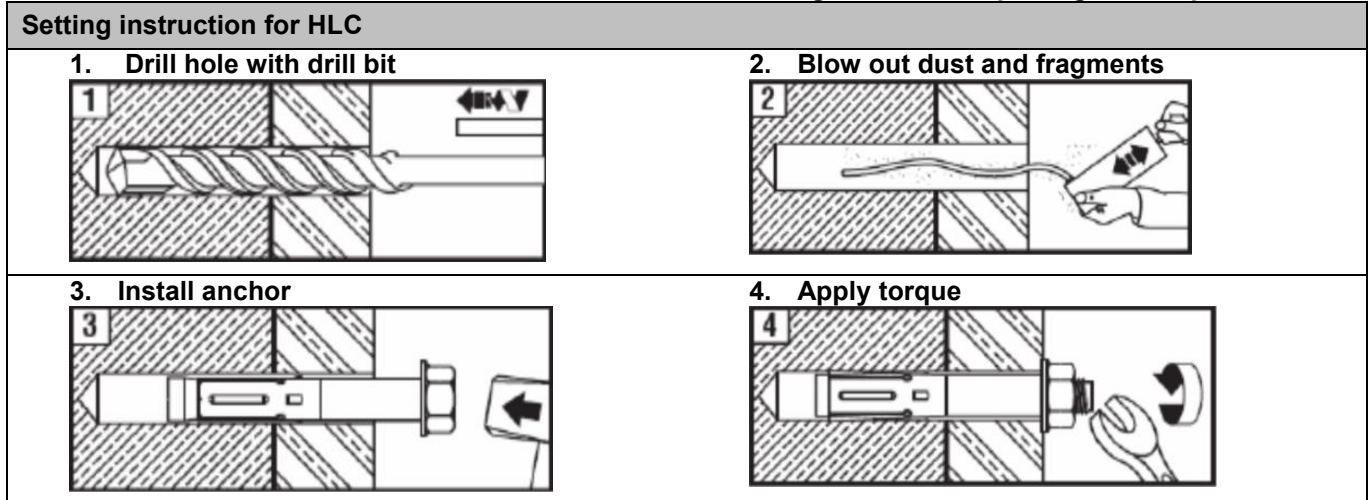

### Basic loading data (for a single anchor) in solid masonry units



#### All data in this section applies to

- Load values valid for holes drilled with TE rotary hammers in hammering mode
- Correct anchor setting (see instruction for use, setting details)
- The core / material ratio may not exceed 15% of a bed joint area.
- The brim area around holes must be at least 70mm
- Edge distances, spacing and other influences, see below

#### Anchorage depth

Anchor size		M5	M6	M8	M10	M12
Nominal anchorage depth	$h_{nom}$ [mm]	16	26	31	33	41

#### Recommended loads<sup>a)</sup>

Anchor size		M5	M6	M8	M10	M12	
<b>Solid clay brick Mz12/2,0 (Germany, Austria, Switzerland)</b>							
	DIN 105/ EN 771-1 $f_b \geq 12 \text{ N/mm}^2$	Tension $N_{Rec}^{c)}$ [kN]	0,3	0,5	0,6	0,7	0,8
		Shear $V_{Rec}^{c)}$ [kN]	0,45	1,0	1,2	1,4	1,6
<b>Solid clay brick Mz12/2,0 (Germany, Austria, Switzerland)</b>							
	DIN 106/ EN 771-2 $f_b \geq 12 \text{ N/mm}^2$	Tension $N_{Rec}^{d)}$ [kN]	0,4	0,5	0,6	0,8	0,8
		Shear $V_{Rec}^{d)}$ [kN]	0,65	1,0	1,2	1,6	1,6

a) Recommended load values for German base materials are based on national regulations.

b)  $f_b$ =brick strength

c) Values only valid for Mz(DIN 105) with brick strength  $\geq 19 \text{ N/mm}^2$ , density  $2,0 \text{ kg/dm}^3$ , min. brick size NF (24,0 cm x 11,5 cm x 11,5 cm)

d) Values only valid for KS(DIN 106) with brick strength  $\geq 29 \text{ N/mm}^2$ , density  $2,0 \text{ kg/dm}^3$ , min. brick size NF (24,0 cm x 11,5 cm x 11,5 cm)

**Permissible anchor location in brick and block walls**

**Anchor position in Brick**

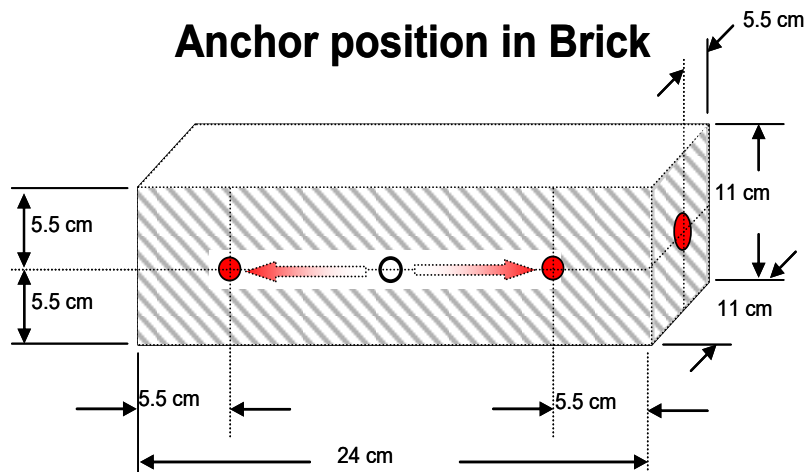

**Edge distance and spacing influences**

- The technical data for the HLC sleeve anchors are reference loads for MZ 12 and KS 12. Due to the large variation of natural stone solid bricks, on site anchor testing is recommended to validate technical data.
- The HLC anchor was installed and tested in center of solid bricks as shown. The HLC anchor was not tested in the mortar joint between solid bricks or in hollow bricks, however a load reduction is expected.
- For brick walls where anchor position in brick cannot be determined, 100% anchor testing is recommended.
- Distance to free edge free edge to solid masonry (Mz and KS) units  $\geq 300$  mm
- The minimum distance to horizontal and vertical mortar joint ( $c_{min}$ ) is stated in the drawing above.
- Minimum anchor spacing ( $s_{min}$ ) in one brick/block is  $\geq 2 \cdot c_{min}$

**Limits**

- Applied load to individual bricks may not exceed 1,0 kN without compression or 1,4 kN with compression
- All data is for multiple use for non-structural applications

Plaster, graveling, lining or levelling courses are regarded as non-bearing and may not be taken into account for the calculation of embedment depth.

# HT Light duty metal anchors

## Economical metal frame anchor

### Anchor version



HT  
(M8-M10)

### Benefits

- Fastening door and window frames
- No risk of distortion or forces of constraint
- Expansion cone cannot be lost

### Base material



Concrete  
(non-cracked)

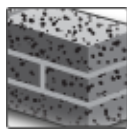

Solid brick

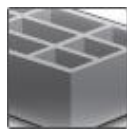

Hollow brick



Autoclaved  
aerated  
concrete

### Load conditions



Fire  
resistance

### Approvals / certificates

Description	Authority / Laboratory	No. / date of issue
Fire test report	IBMB, Braunschweig	UB 3016/1114-CM / 2006-03-13
Assessment report (fire)	warringtonfire	WF 327804/A / 2013-07-10

### Basic loading data ( for a single anchor)

#### All data in this section applies to:

- Correct setting (See setting instruction)
- No edge distance and spacing influence
- Base material as specified in the table
- Non-cracked concrete:  $f_{cc} \geq 20 \text{ N/mm}^2$
- Minimum base material thickness

#### Characteristic resistance

Anchor size		HT 8	HT 10
Concrete, $f_{cc}=30 \text{ N/mm}^2$	$N_{Rk}$ [kN]	4,2	5,0
	$V_{Rk}$ [kN]	6,6	7,0
Aerated concrete PP2 <sup>a)</sup>	$N_{Rk}$ [kN]	-	0,3
	$V_{Rk}$ [kN]	-	0,5
Solid brick Mz 12	$N_{Rk}$ [kN]	1,8	2,6
	$V_{Rk}$ [kN]	-	5,0
Sand-lime solid brick, KS 12	$N_{Rk}$ [kN]	1,8	2,6
	$V_{Rk}$ [kN]	-	5,0
Sand-lime hollow brick, KSL	$N_{Rk}$ [kN]	-	1,5
	$V_{Rk}$ [kN]	-	0,5

a) Rotary drilling only.

### Recommended loads

Anchor size		HT 8	HT 10
Concrete, $f_{cc}=30 \text{ N/mm}^2$	$N_{Rec}$ [kN]	1,4	1,7
	$V_{Rec}$ [kN]	0,5	0,5
Aerated concrete PP2 <sup>a)</sup>	$N_{Rec}$ [kN]	-	0,1
	$V_{Rec}$ [kN]	-	0,15
Solid brick Mz 12	$N_{Rec}$ [kN]	0,6	0,8
	$V_{Rec}$ [kN]	-	0,5
Sand-lime solid brick, KS 12	$N_{Rec}$ [kN]	0,6	0,8
	$V_{Rec}$ [kN]	-	0,5
Sand-lime hollow brick, KSL	$N_{Rec}$ [kN]	-	0,5
	$V_{Rec}$ [kN]	-	0,15

a) Rotary drilling only.

### Materials

#### Material quality

Part	Material
Bolt	Steel strength 4.8, zinc plated to 5 $\mu\text{m}$
Sleeve	Steel 02 DIN 17162, sendzimir zinc plated to 20 $\mu\text{m}$

### Setting information

#### Setting details

Anchor size		HT 8	8x72	8x92	8x112	8x132	8x152	8x182
Nominal diameter of drill bit	$d_0$ [mm]	8	8	8	8	8	8	8
Depth of drill hole	$h_1$ [mm]	50	50	50	50	50	50	50
Anchorage depth	$h_{nom}$ [mm]	30	30	30	30	30	30	30
Anchor length	L [mm]	72	92	112	132	152	182	
Torque moment	$T_{inst}^{a)}$ [Nm]	100	100	100	100	100	100	100
Minimum base material thickness	$h_{min}$ [mm]	4	4	4	4	4	4	4
Drill bit		TE-CX-8/17		TE-CX-8/22		TE-CX-8/27		

#### Setting details

Anchor size		HT 10	10x72	10x92	10x112	10x132	10x152	10x182	10x202
Nominal diameter of drill bit	$d_0$ [mm]	10	10	10	10	10	10	10	10
Depth of drill hole	$h_1$ [mm]	50	50	50	50	50	50	50	50
Anchorage depth	$h_{nom}$ [mm]	30	30	30	30	30	30	30	30
Anchor length	L [mm]	72	92	112	132	152	182	202	
Torque moment	$T_{inst}^{a)}$ [Nm]	100	100	100	10	10	10	10	10
Minimum base material thickness	$h_{min}$ [mm]	8/4	8/4	8/4	8/4	8/4	8/4	8/4	8/4
Drill bit		TE-C-10/17		TE-C-10/22		TE-C-10/27		TE-C-10/37	

a) First value: solid base material, second value: hollow base material.

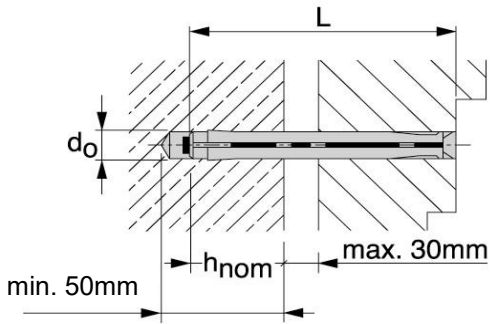

**Installation equipment**

Anchor size	HT 8	HT 10
Rotary hammer	TE1-TE16	
Other tools	hammer, screwdriver	

**Setting instruction**

\*For detailed information on installation see instruction for use given with the package of the product.

Setting instruction		
<b>1. Drill hole with the drill bit</b> 	<b>2. Install anchor</b> 	<b>3. Drive screw into anchor</b> 



# HLV Light duty anchors

## Economical sleeve anchor

### Anchor version



HLV  
Pre-setting  
(M5-M12)



HLV  
Through fastening  
(M6-M12)

### Benefits

- Available in a variety of sizes in both pre-setting and through fastening configurations
- Carbon steel grade 4.8, zinc galvanized to min 5µm

### Base material



Concrete  
(non-cracked)

### Static resistance

All data in this section is Hilti technical data and applies to:

- Correct setting (See setting instruction)
- No edge distance and spacing influence
- Minimum base material thickness
- Concrete C 20/25,  $f_{ck,cube} = 25 \text{ N/mm}^2 - 60 \text{ n/mm}^2$

### Characteristic resistance

Anchor size		Pre-setting						Through fastening			
		6,5x22/7	8x35/4	10x45/10	12x48/10	12x60/17	16x68/20	8x35/10	10x75/45	12x95/60	16x130/90
Tension $N_{Rk}$	[kN]	5,2	7,1	13,0	15,9	21,9	28,3	5,6	8,3	10,5	12,8
Shear $V_{Rk}$	[kN]	3,3	5,6	11,4	13,0	13,0	19,7	5,6	8,3	10,5	12,8

### Design resistance

Anchor size		Pre-setting						Through fastening			
		6,5x22/7	8x35/4	10x45/10	12x48/10	12x60/17	16x68/20	8x35/10	10x75/45	12x95/60	16x130/90
Tension $N_{Rd}$	[kN]	2,5	3,4	6,1	7,5	10,4	13,5	2,7	4,0	5,0	6,1
Shear $V_{Rd}$	[kN]	1,5	2,6	5,4	6,1	6,1	9,4	2,7	4,0	5,0	6,1

### Recommended loads<sup>a)</sup>

Anchor size		Pre-setting						Through fastening			
		6,5x22/7	8x35/4	10x45/10	12x48/10	12x60/17	16x68/20	8x35/10	10x75/45	12x95/60	16x130/90
Tension $N_{Rec}$	[kN]	1,7	2,4	4,3	5,3	7,4	9,6	1,9	2,8	3,6	4,3
Shear $V_{Rec}$	[kN]	1,0	1,8	3,8	4,3	4,3	6,7	1,9	2,8	3,6	4,3

a) With overall partial safety factor for action  $\gamma = 1,4$ . The partial safety factors for action depend on the type of loading and shall be taken from national regulations.

### Materials

#### Material quality

Part	Material
Anchor body	Carbon steel, $f_{uk} \geq 400$ N/mm <sup>2</sup> galvanised to min. 5 $\mu$ m

### Anchor dimensions

Anchor size		Pre-setting						Through fastening			
		6,5x22/7	8x35/4	10x45/10	12x48/10	12x60/17	16x68/20	8x35/10	10x75/45	12x95/60	16x130/90
Thread size	d [-]	M5	M6	M8	M10		M12	M6	M8	M10	M12
Anchor diameter	$d_1$ [mm]	6,5	8	10	12		16	8	10	12	16
Length of anchor bolt	l [mm]	39	51	68	76	95	109	47	88	114	152
Length of sleeve	$l_s$ [mm]	22	35	45	48	60	68	35	75	95	130

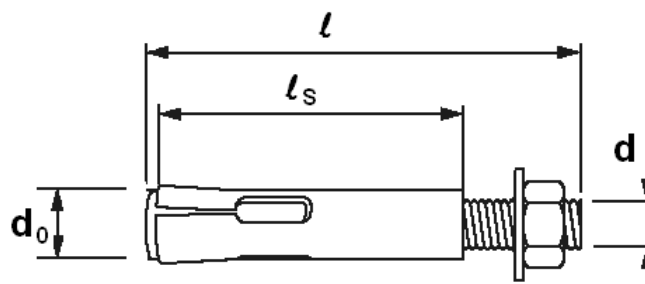

## Setting information

### Setting details HLV

Anchor size	Pre-setting						Through fastening			
	6,5x22/7	8x35/4	10x45/10	12x48/10	12x60/17	16x68/20	8x35/10	10x75/45	12x95/60	16x130/90
Thread size	M5	M6	M8	M10		M12	M6	M8	M10	M12
Thickness of fixture $t_{fix} \leq$ [mm]	7	4	10	10	17	20	10	45	60	90
Nominal diameter of drill bit $d_o$ [mm]	6,5 (1/4")	8	10	12		16	8	10	12	16
Cutting diameter of drill bit $d_{cut} \leq$ [mm]	6,4	8,45	10,45	12,5		16,5	8,45	10,45	12,5	16,5
Depth of drill hole $h_1 \geq$ [mm]	40	50	65	70	80	100	40	50	55	70
Width across nut flats SW [mm]	8	10	13	17		19	10	13	17	19
Diameter of clearance hole in the fixture $d_f \leq$ [mm]	6	7	9	11	11	14	10	12	14	18
Effective anchorage depth $h_{ef}$ [mm]	22	35	45	48	60	68	25	30	35	40
Max. torque moment $T_{inst}$ [Nm]	2	4	25	40		50	4	25	40	50

### Installation equipment

Anchor size	6,5	8	10	M12	M16
Rotary hammer for setting	TE 2 – TE 16				
Other tools	hammer, torque wrench, blow up pump				

### Setting parameters

Anchor size	Pre-setting						Through fastening			
	6,5x22/7	8x35/4	10x45/10	12x48/10	12x60/17	16x68/20	8x35/10	10x75/45	12x95/60	16x130/90
Minimum base material $h_{min} \geq$ [kN]	80	80	90	100	120	140	80 <sup>a)</sup>	80 <sup>a)</sup>	80 <sup>a)</sup>	80 <sup>a)</sup>
Minimum spacing $s_{min} \geq$ [mm]	200	200	200	200	240	280	200	200	200	200
Minimum edge distance $c_{min} \geq$ [mm]	100	105	135	150	180	210	100	100	105	120

a) In case of deeper embedment than  $h_{ef}$ ,  $h_{min} \geq 2x$  embedment depth.

Setting instruction

\*For detailed information on installation see instruction for use given with the package of the product.

Setting instruction	
Pre-setting	
<p><b>1.</b></p>	<p><b>2. Drilling</b></p>
<p><b>3. Cleaning</b></p>	<p><b>4. Inserting the anchor</b></p>
<p><b>5. Inserting the anchor by hammer</b></p>	<p><b>6. Attaching the belonging washer</b></p>
Through fastening	
<p><b>1.</b></p>	<p><b>2. Drilling</b></p>
<p><b>3. Cleaning</b></p>	<p><b>4. Inserting the anchor by hammer</b></p>
<p><b>5. Attaching the belonging washer</b></p>	

# HAM Light duty metal anchors

## Economical sleeve anchor

### Anchor version



HAM  
8.8 screw  
(M6-M12)



HAM  
(M6-M12)

### Benefits

- Secure fastenings in various base materials
- Cone attached to sleeve to ensure pre-setting
- Wings to prevent spinning in the borehole
- Plastic cap in cone to prevent dust entrance
- Blue-chromate zinc coating
- 8.8 steel strength of screw

### Base material



Concrete  
(non-cracked)

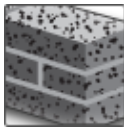

Solid brick

### Basic loading data (for a single anchor)

#### All data in this section applies to:

- Correct setting (See setting instruction)
- No edge distance and spacing influence
- Concrete as specified in the table
- *Steel* failure
- Minimum base material thickness
- Concrete C 20/25,  $f_{ck,cube} = 25 \text{ N/mm}^2$

#### Recommended loads in non-cracked concrete C20/25

Thread diameter		M6x50	M8x60	M10x80	M12x90
Tension $N_{Rec}$	[kN]	4,0	4,8	5,8	8,7
Shear $V_{Rec}$	[kN]	4,6	8,4	13,3	19,3

#### Recommended loads in solid bricks

Thread diameter		M6x50	M8x60	M10x80	M12x90
Tension $N_{Rec}$	[kN]	For solid brick, load values need to be determined on the building site			
Shear $V_{Rec}$	[kN]				



## Materials

### Material quality

Part	Material
Sleeve	Carbon steel
HAM Anchor Hex head Bolt	Carbon steel DIN 933, Strength 8.8
Washer	Carbon steel, DIN 9021

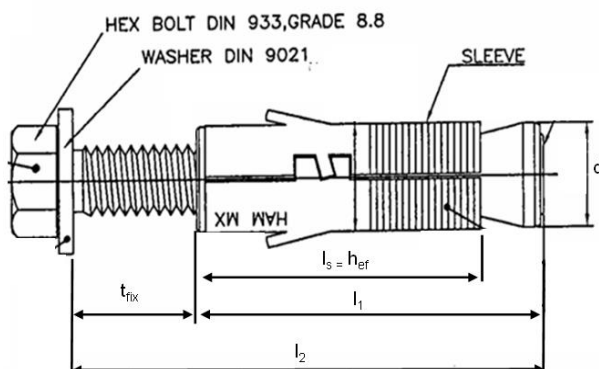

### Anchor dimension of HAM

Anchor size		M6x50	M8x60	M10x80	M12x90
Effective anchorage depth	$h_{ef}$ [mm]	30	35	43	55
Anchor diameter	$d$ [mm]	12	14	16	19
Effective anchorage length	$l_s = h_{ef}$ [mm]	30	35	43	55
Length of expansion sleeve	$l_1$ [mm]	40	50	60	70
Length of anchor	$l_2$ [mm]	50	60	80	90
Thickness of the fixture	$t_{fix}$ [mm]	10	10	20	20

## Setting

### Setting details of HAM

Anchor size		M6x50	M8x60	M10x80	M12x90
Nominal diameter of drill bit	$d_0$ [mm]	12	14	16	20
Cutting diameter of drill bit	$d_{cut} \leq$ [mm]	12,5	14,5	16,5	20,55
Depth of drill hole	$h_1 \geq$ [mm]	65	80	90	110
Width across nut flats	SW [mm]	10	13	17	19
Diameter of clearance hole in the fixture	$d_f \leq$ [mm]	7	9	12	14
Max. torque moment concrete	$T_{inst}$ [Nm]	10	25	45	75
Max. torque moment masonry	$T_{inst}$ [Nm]	5	10	20	30

### Installation equipment

Anchor size		M6x50	M8x60	M10x80	M12x90
Rotary hammer for setting		TE 2 – TE 16			
Drill bit	TE-C3X	12	14	16	20
Other tools		hammer, torque wrench, blow up pump			

# HPD Light duty metal anchors

## Aerated concrete anchor

### Anchor version



HPD

### Benefits

- Anchor for autoclaved aerated concrete
- Maximum use of base material capacity
- Setting without drilling

### Base material



Autoclaved aerated concrete

### Load conditions



Fire resistance

### Other information



Sprinkler approved

### Approvals / certificates

Description	Authority / Laboratory	No. / date of issue
Allgemeine bauaufsichtliche Zulassung (national approval in Germany) <sup>a)</sup>	DIBt, Berlin	Z-21.1-1729 / 2011-05-31
Fire test report	IBMB, Braunschweig	UB 3077/3602-Nau- / 2002-02-05
Assessment report (fire)	warringtonfire	WF 327804/A / 2013-07-10
Sprinkler	VdS, Cologne	G 4981083 / 2008-01-01

### Basic loading data

#### All data in this section applies to:

- Correct setting (See setting instruction)
- No edge distance and spacing influence
- Autoclaved aerated concrete (AAC)
- Load data given in the tables is independent of load direction
- Minimum base material thickness

#### Recommended loads for a single anchor

Anchor size		M6	M8	M10
<b>Non-cracked AAC<sup>a)</sup></b>				
AAC blocks	AAC 2 [kN]	0,4	0,4	0,6
	AAC 4, AAC 6 [kN]	0,8	0,8	1,2
AAC wall members	P 3,3 [kN]	0,6	0,6	0,8
	P 4,4 [kN]	0,8	0,8	1,2
<b>Cracked AAC</b>				
AAC ceiling members	P 3,3 [kN]	0,6	0,6	0,8
	P 4,4 [kN]	0,8	0,8	1,2

a) In case of small sized AAC blocks (<= 250mm x 500mm x thickness) the recommended load has to be reduced with a factor 0,6.

**Recommended loads for a group of two anchor with a spacing  $100\text{mm} \leq s \leq 200\text{mm}$** 

Anchor size		M6	M8	M10	
<b>Non-cracked AAC<sup>a)</sup></b>					
AAC blocks	AAC 2	[kN]	0,4	0,4	0,6
	AAC 4, AAC 6	[kN]	0,8	0,8	1,2
AAC wall members	P 3,3	[kN]	0,6	0,6	0,8
	P 4,4	[kN]	0,8	0,8	1,2
<b>Cracked AAC</b>					
AAC ceiling members	P 3,3	[kN]	0,6	0,6	0,8
	P 4,4	[kN]	0,8	0,8	1,2

a) In case of small sized AAC blocks ( $\leq 250\text{mm} \times 500\text{mm} \times \text{thickness}$ ) the recommended load has to be reduced with a factor 0,6.

**Recommended loads for a group of two anchor with a spacing  $s \geq 200\text{mm}$** 

Anchor size		M6	M8	M10	
<b>Non-cracked AAC<sup>a)</sup></b>					
AAC blocks	AAC 2	[kN]	0,6	0,6	0,8
	AAC 4, AAC 6	[kN]	1,1	1,1	1,7
AAC wall members	P 3,3	[kN]	0,8	0,8	1,1
	P 4,4	[kN]	1,1	1,1	1,7
<b>Cracked AAC</b>					
AAC ceiling members	P 3,3	[kN]	0,8	0,8	1,1
	P 4,4	[kN]	1,1	1,1	1,7

a) In case of small sized AAC blocks ( $\leq 250\text{mm} \times 500\text{mm} \times \text{thickness}$ ) the recommended load has to be reduced with a factor 0,6.

**Materials**
**Mechanical properties**

Anchor size		M6	M8	M10	
Nominal tensile strength	$f_{uk}$	Carbon steel	800	500	500
		Stainless steel	750	565	565
Yield strength	$f_{yk}$	Carbon steel	-	-	-
		Stainless steel	-	-	-
Stressed cross-section	$A_s$	[mm <sup>2</sup> ]	20,1	36,6	58
Moment of resistance	$W$	[mm <sup>3</sup> ]	12,7	31,2	62,3
Char. bending resistance for rod or bolt	$M^0_{Rk,s}$	Carbon steel	12	19	37
		Stainless steel	11	21	42

The recommended bending moment shall be calculated by dividing the characteristic bending moment by 1,4 and 1,25.

**Material quality**

Part	Material	
All parts	HPD	Carbon steel, galvanised to min. 5 $\mu\text{m}$
	HPD (stainless steel)	Stainless steel

**Anchor dimension**

Anchor size		M6	M8	M10	
Minimum thickness of fixture	$t_{fix,min}$	[mm]	0	0	0
Maximum thickness of fixture*	$t_{fix,max}$	[mm]	30	20	30
Anchor diameter	$d_1$	[mm]	9,8	11,8	13,8
Length of the expansion sleeve	$l_c$	[mm]	70		
Length of the cone	$l_d$	[mm]	12		

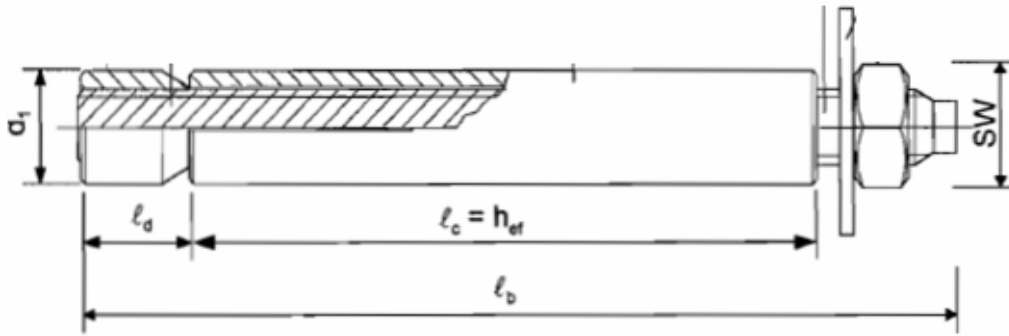

### Setting information

#### Setting details

Anchor size			M6	M8	M10
Diameter of clearance hole in the fixture	$d_f \leq$	[mm]	7	9	12
Effective anchorage depth	$h_{ef}$	[mm]	62	62	62
Torque moment	$T_{inst}$	[Nm]	3	5	8
Width across	SW	[mm]	10	13	17

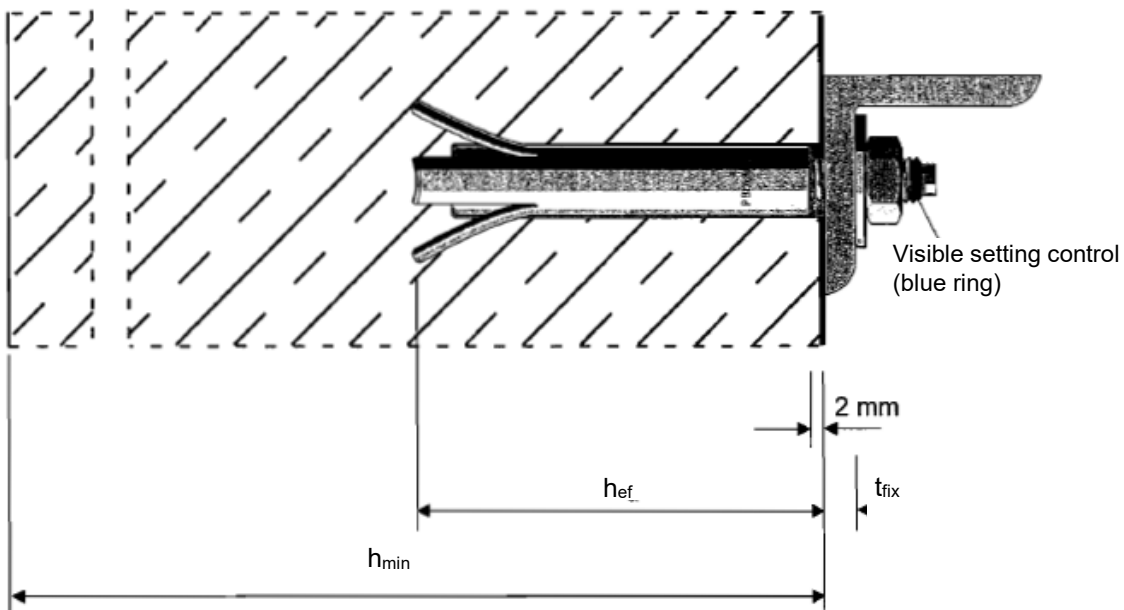

#### Installation equipment

Anchor size		M6/10	M6/30	M8/10	M8/20	M10/10	M10/30
Setting tool	Manual setting tool (to be used with a hammer)	HPE-G 6/10	HPE-G 6/30	HPE-G 8/10	HPE-G 8/20	-	-
	Machine setting (to be used with a rotary hammer in pure hammering mode)	-	-	-	-	HPE-M 10/10	HPE-M 10/30

#### Setting parameters

Anchor size			M6	M8	M10
Minimum base material thickness	$h_{min}$	[mm]	175		
Min. spacing	Of anchors in a group	$s_{min,anchor}$	100 / 200		
	Of anchor groups	$s_{min,group}$	600		
Min. edge distance	to member edge and to vertical joints	$c_{min,1}$	150	150	150
	to horizontal joints	$c_{min,2}$	50	50	50

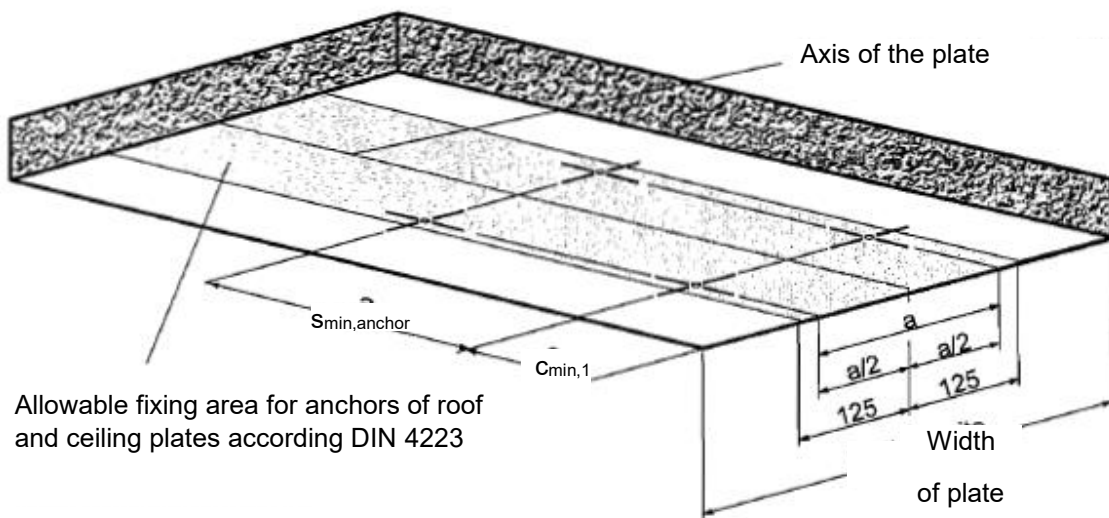
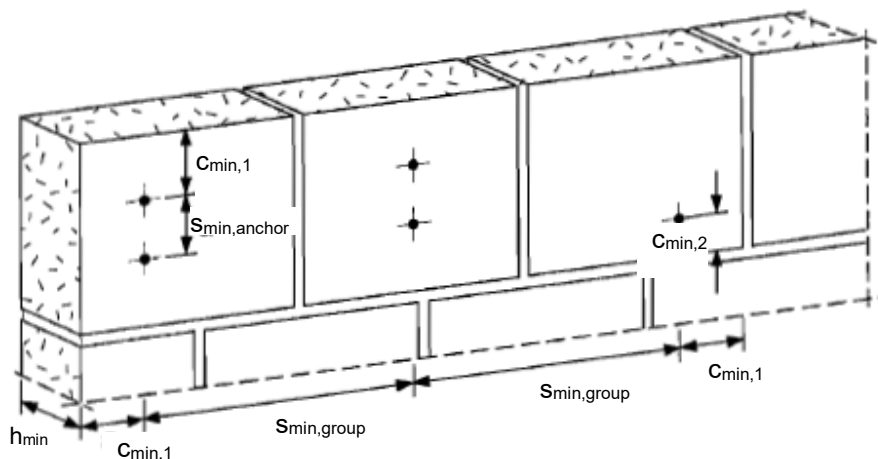

Allowable fixing area for anchors of roof and ceiling plates according DIN 4223

### Setting instruction

\*For detailed information on installation see instruction for use given with the package of the product.

#### Setting instruction

1. Insert the cone bolt by hammering it in, until setting tool touches surface.



2. Insert the expansion sleeve over the threaded rod.

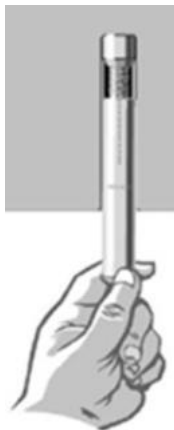

3. Drive in the sleeve by hammering or with the machine setting tool.

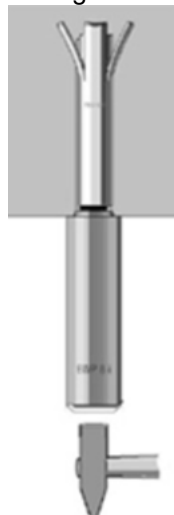

4. Tighten the nut until the blue ring becomes visible.

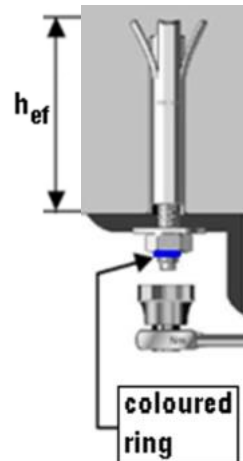

# HKH Light duty metal anchors

## Hollow deck anchor

### Anchor version



HKH  
(M6-M10)

### Benefits

- Anchor for suspended ceilings and overhead support applications
- Channel installation
- Optical setting control

### Base material



Prestressed hollow core slabs

### Load condition



Fire resistance



Corrosion resistance

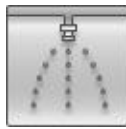

Sprinkler approved

### Approvals / certificates

Description	Authority / Laboratory	No. / date of issue
Allgemeine bauaufsichtliche Zulassung (national approval in Germany for a single point fastening) <sup>a)</sup>	DIBt, Berlin	Z-21.1-1722 / 2011-10-31
Fire test report	IBMB, Braunschweig	UB 3606 / 8892 / 2002-07-22
Assessment report (fire)	warringtonfire	WF 327804/A / 2013-07-10
Sprinkler	VdS, Cologne	G 4961028 / 2006-09-05

<sup>a)</sup> All data given in this section according DIBt Z-21.1-1722, issue 2011-10-31.

## Basic loading data

### All data in this section applies to:

- Correct setting (See setting instruction)
- No edge distance and spacing influence
- Hollow decks where  $b_H \leq 4,2 \cdot b_{st}$
- Hollow decks, classification  $\geq C 45/55$
- Concrete  $f_{cc} \geq 50 \text{ N/mm}^2$

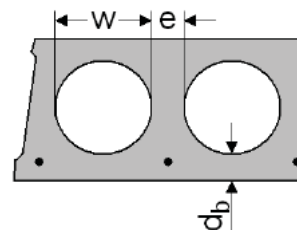

### Recommended loads

Anchor size	M6	M8	M10	M6	M8	M10	M6	M8	M10	
Cavity to surface thickness $d_b$ [mm]	$\geq 25$			$\geq 30$			$\geq 40$			
<b>For a single anchor</b>										
Tension $F_{rec}$ [kN]	0,7	0,7	0,9	0,9	0,9	1,2	2,0	2,0	3,0	
<b>For a group of two anchors with a spacing <math>s \geq 100 \text{ mm}</math> and <math>\leq 200 \text{ mm}</math></b>										
Tension $F_{rec}$ [kN]	spacing $s \geq 100 \text{ mm}$	0,9	0,9	1,2	1,2	1,2	1,6	2,5	2,5	4,0
	spacing $s \geq 200 \text{ mm}$	1,1	1,1	1,5	1,5	1,5	2,0	3,3	3,3	5,0
<b>For a group of four anchors with a spacing <math>s \geq 100 \text{ mm}</math> and <math>\leq 200 \text{ mm}</math></b>										
Tension $F_{rec}$ [kN]	spacing $s \geq 100/100 \text{ mm}$	1,2	1,2	1,6	1,6	1,6	2,1	3,5	3,5	5,3
	spacing $s \geq 100/200 \text{ mm}$	1,5	1,5	2,0	2,0	2,0	2,6	4,4	4,4	6,6
	spacing $s \geq 200/200 \text{ mm}$	1,9	1,9	2,5	2,5	2,5	3,3	5,5	5,5	8,3

The given loads are valid for tension load, shear load and all load directions.

## Materials

### Mechanical properties

Anchor size	M6	M8	M10	
Nominal tensile strength $f_{uk}$ [N/mm <sup>2</sup> ]	Carbon steel	800	500	500
	Stainless steel	700	700	700
Admissible bending resistance [Nm]	Carbon steel	7,0	10,7	21,4
	Stainless steel	4,9	12,1	24,1

### Material quality

Part	Material	
All parts	HKH (Carbon steel)	Galvanised to min. 5 $\mu\text{m}$
	HKH (Stainless steel)	Stainless steel A4

### Anchor dimension

Anchor size	M6	M8	M10
Thickness of fixture $t_{fix}$ [mm]	$\leq 10$	$\leq 10$	$\leq 10$
Length of the spacer sleeve $l_1$ [mm]	0	0	0
Length of the part of the sleeve $l_{st}$ [mm]	10	10	10
Anchor diameter $d$ [mm]	9,8	11,8	13,8
Length of the bolt $l$ [mm]	86	88	93
Length of the part of the sleeve $l_h$ [mm]	55		



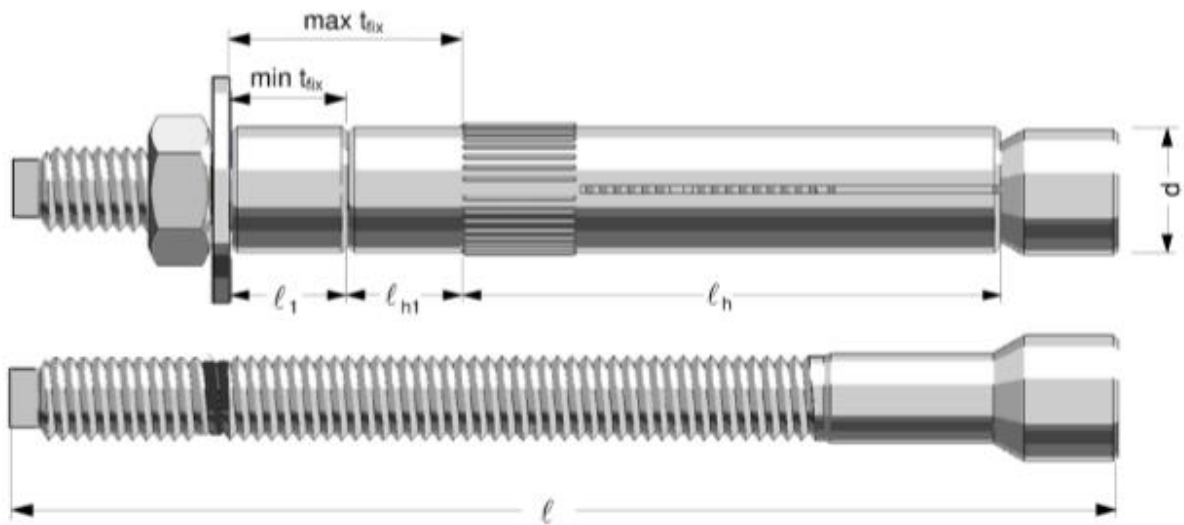

## Setting information

### Setting details

Anchor size		M6	M8	M10
Diameter of clearance hole in the fixture	$d_f \leq$ [mm]	12	14	16
Embedment depth for HKH	$h_s$ [mm]	55 to 65		
Torque moment	$T_{inst}$ [Nm]	5	10	20
Width across	SW [mm]	10	13	17

### Installation equipment

Anchor size	M6	M8	M10
Drill bit	TE-CX-10	TE-CX-12	TE-CX-14
Rotary hammer	TE 6A, TE 6C, TE 6S, TE 15, TE 15-C, TE 18-M		
Setting tools	Torque wrench		
Machine setting tool	available		

### Setting parameters

Anchor size		M6	M8	M10
Edge distance <sup>a)</sup>	$c \geq$ [mm]	150		
	$c_{min} \geq$ [mm]	100		
Spacing between outer anchors of neighbouring fixation	$a \geq$ [mm]	300		

a) For edge distance < 150 mm the recommended load has to be reduced with  $F=0,75 \cdot F_{rec}$ .

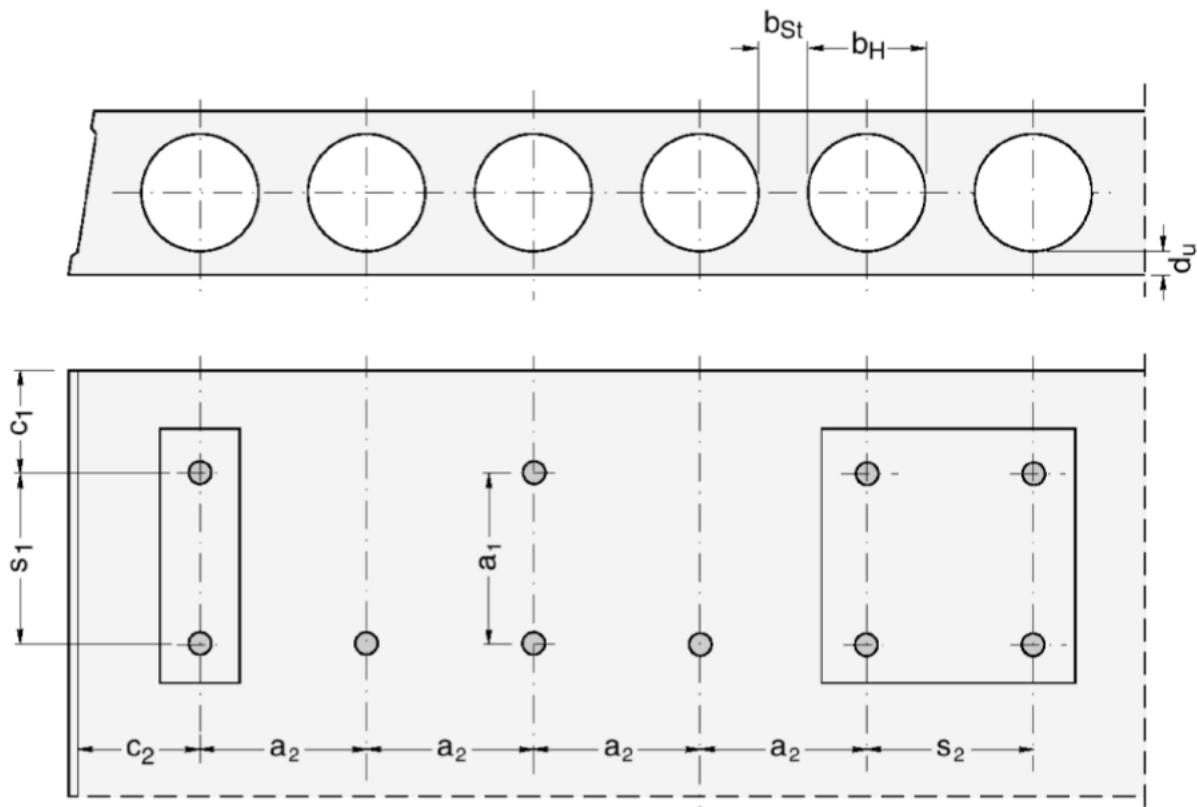

### Setting instruction

\*For detailed information on installation see instruction for use given with the package of the product.

Setting instruction		
<b>1. Drill the hole</b> 	<b>2. Insert the anchor</b> 	<b>3. Setting mark must be visible</b> 

# HCA Light duty metal anchors

## Economical coil anchor

### Anchor version



HCA 5/8"

### Benefits

- Re-usable up to 140 times
- High load capacity
- Big washer  $\varnothing$  34 mm
- For temporary external applications

### Base material

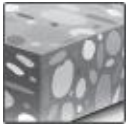

Concrete  
(non-cracked)



Tensile zone

### Other information



DIBt  
Approval  
Reusability

### Approvals / certificates

Description	Authority / Laboratory	No. / date of issue
DIBt approval (reusability)	DIBt, Berlin	Z-21.8-2027 / 2014-05-14

### Basic loading data

#### For temporary application:

##### All data in this section applies to:

- Correct setting (See setting instruction)
- No edge distance and spacing influence
- Base material as specified in the table

#### For temporary application in standard and fresh concrete < 28 days old:

##### All data in this section applies to:

- Strength class,  $f_{ck,cube} \geq 10 \text{ N/mm}^2$
- Only temporary use
- Screw is reusable, before each usage it must be checked according Hilti instruction for use with the suited tube Hilti HRG
- Design resistance are valid for single anchor only
- Design resistance are valid for all load direction and valid for both cracked and non-cracked concrete
- Minimum base material thickness
- No edge distance and spacing influence

#### Design resistance for all directions in cracked and non-cracked concrete

Anchor		HCA 5/8" x 90	HCA 5/8" x 130
<b>Length in concrete</b>	$h_{nom} \geq$ [mm]	<b>80</b>	<b>115</b>
For concrete strength $\geq 10 \text{ N/mm}^2$	$F_{Rd}^{(1)}$ [kN]	4	12
For concrete strength $\geq 15 \text{ N/mm}^2$	$F_{Rd}^{(1)}$ [kN]	5	15
For concrete strength $\geq 20 \text{ N/mm}^2$	$F_{Rd}^{(1)}$ [kN]	6	18

## Materials

### Material quality

Part	Material
Anchor HCA 5/8"	Steel galvanized; $f_{uk} \geq 850 \text{ N/mm}^2$
Coil HCT	Steel galvanized; $350 \text{ N/mm}^2 \leq f_{uk} \leq 800 \text{ N/mm}^2$

### Anchor dimensions

Anchor		HCA 5/8" x 90	HCA 5/8" x 130
Length in concrete	$h_{nom} \geq$ [mm]	80	115
Anchor length	$l$ [mm]	90	125
Length of thread	$l_s$ [mm]	51	
Outer diameter	$d_t$ [mm]	15,8	
Core diameter	$d_k$ [mm]	13,1	
Marking for correct installation	$h_s$ [mm]	20	
Cross section	$A_s$ [mm <sup>2</sup> ]	196,1	

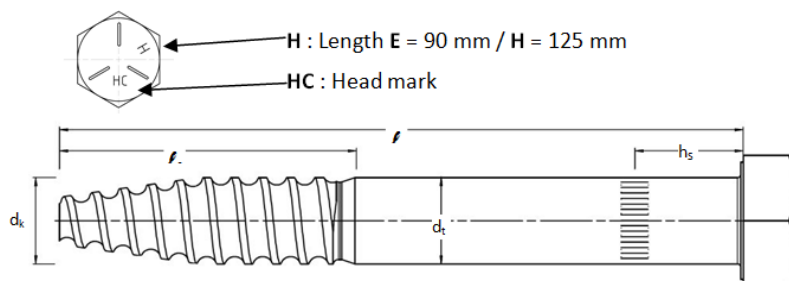

### Coil dimensions

Anchor		HCT
Anchor length	$l$ [mm]	29,3
Length of thread	$h$ [mm]	15,6

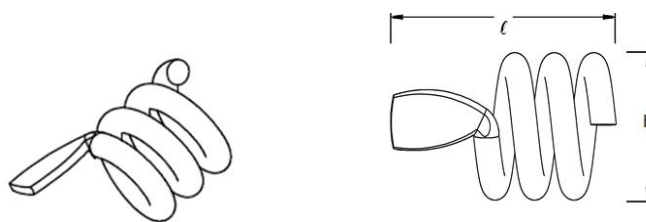

### Tube specification

Tube		HRG 16
Inner tube diameter	$\varnothing_i$ [mm]	15,1
Outer tube diameter	$\varnothing_e$ [mm]	20,0
Tube length	$L_t$ [mm]	30,0

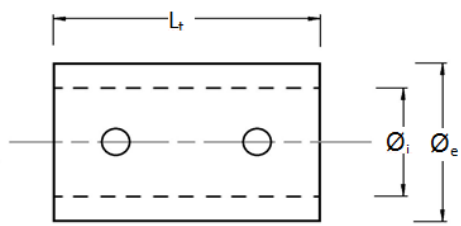

## Setting information

### Setting details HCA

Anchor			HCA 5/8" x 90	HCA 5/8" x 130
<b>Length in concrete</b>	$h_{nom} \geq$	[mm]	<b>80</b>	<b>115</b>
Nominal diameter of drill bit	$d_0$	[mm]	16	
Cutting diameter of drill bit	$d_{cut} \leq$	[mm]	16,5	
Diameter of clearance hole in the	$d_f$	[mm]	18	
Wrench size (H-type)	SW	[mm]	24	
Thickness of fixture	$t_{fix}$	[mm]	0 ... 10	
Depth of drill hole	$h_1 \geq$	[mm]	95 - $t_{fix}$	95 - $t_{fix}$
Torque moment	$T_{min}$	[Nm]	180	

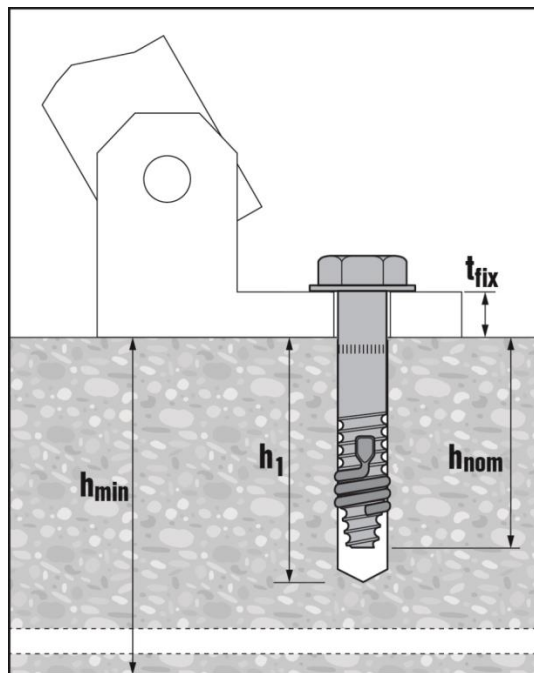

### Installation equipment

Anchor	HCA
Rotary hammer	TE 2 – TE 80
Other tools	Hammer, torque wrench, blow out pump

### Setting parameters HCA

Anchor			HCA 5/8" x 90	HCA 5/8" x 130
<b>Length in concrete</b>	$h_{nom} \geq$	[mm]	<b>80</b>	<b>115</b>
Min. thickness of concrete member	$h_{min}$	[mm]	200	200
Min. spacing	$s_{min}$	[mm]	125	550
Min. edge distance (load direction 1)	$c_{1,min}$	[mm]	150	350
Min. edge distance (load direction 2)	$c_{2,min}$	[mm]	200	500

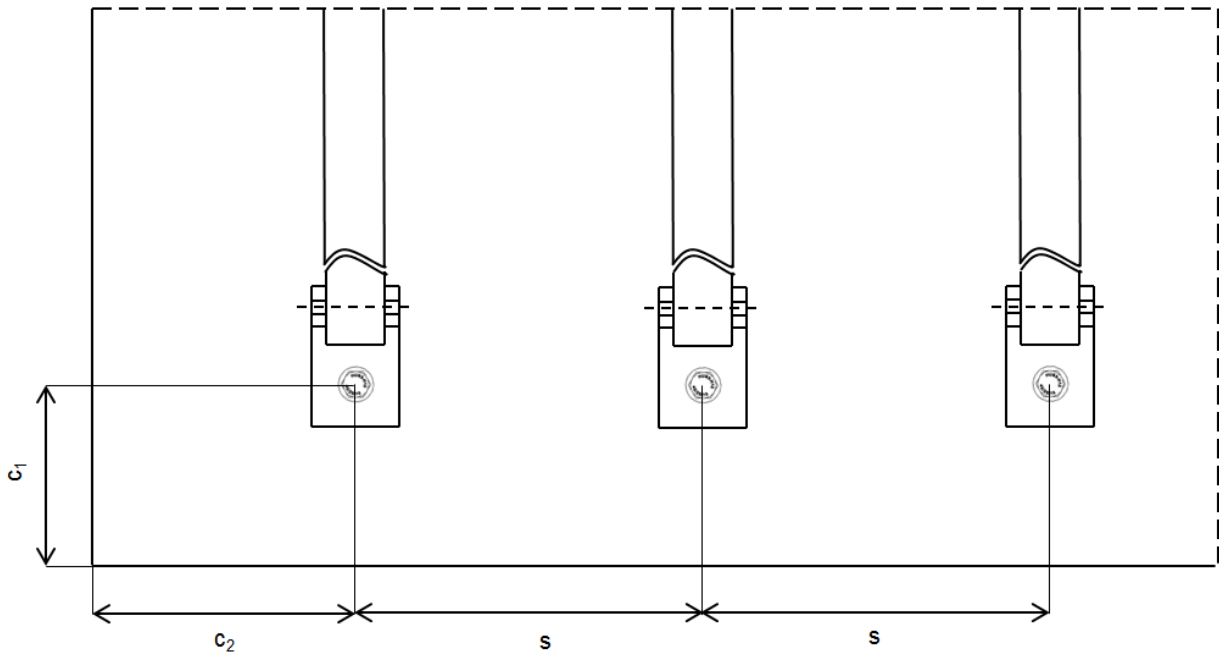

**Setting instruction**

\*For detailed information on installation see instruction for use given with the package of the product.

Setting instructions	
<p><b>1. Drill the hole</b></p>	<p><b>2. Cleaning</b></p>
<p><b>3. Position coil</b></p>	<p><b>4. Inserting the anchor</b></p>
<p><b>5. Attaching the belonging washer</b></p>	

# HHD-S Light duty metal anchors

## Economical cavity anchor

### Anchor version



HHD-S  
(M4-M8)

### Benefits

- Metal undercut anchor with metric screw, especially for drywall
- Metal to metal fastening
- Reliable undercut

### Base material



Drywall

### Basic loading data (for a single anchor)

#### All data in this section applies to:

- Correct setting (See setting instruction)
- No edge distance and spacing influence
- Base material as specified in the table
- Borehole drilling without hammering

#### Recommended loads<sup>a)</sup>

Anchor size		M4	M5	M6	M8
Hollow brick web thickness 20mm	N <sub>Rd</sub> [kN]	0,1	-	-	-
	V <sub>Rd</sub> [kN]	0,3	-	-	-
Gypsum board Thickness 10mm	N <sub>Rd</sub> [kN]	0,2	0,2	0,2	0,2
	V <sub>Rd</sub> [kN]	0,5	0,5	0,5	0,5
Gypsum board Thickness 12,5mm	N <sub>Rd</sub> [kN]	0,2	0,2	0,2	0,2
	V <sub>Rd</sub> [kN]	0,5	0,5	0,5	0,5
Gypsum board Thickness 2x12,5mm	N <sub>Rd</sub> [kN]	-	0,4	0,3	0,4
	V <sub>Rd</sub> [kN]	-	1	0,9	1
Fibre reinforced gypsum board Thickness 10mm	N <sub>Rd</sub> [kN]	0,2	0,3	0,25	0,4
	V <sub>Rd</sub> [kN]	0,5	0,6	0,8	0,9
Fibre reinforced gypsum board Thickness 12,5mm	N <sub>Rd</sub> [kN]	0,3	0,5	0,3	0,6
	V <sub>Rd</sub> [kN]	0,6	1	1	1,2
Fibre reinforced gypsum board Thickness 2x12,5mm	N <sub>Rd</sub> [kN]	-	0,9	0,8	0,9
	V <sub>Rd</sub> [kN]	-	1,1	1,8	1,7

a) With overall global safety factor  $\gamma = 3$  to the characteristic loads and a partial safety factor of  $\gamma = 1,4$  to the design values.

### Materials

#### Material quality

Part	Material
Sleeve	Carbon steel, galvanised
Screw	Carbon steel, galvanised



## Setting information

### Setting details HHD-S

Anchor		M4x4	M4x6	M4x12	M4x19	M5x8	M5x12	M5x25
Nominal diameter of drill	$d_o$ [mm]	8	8	8	8	10	10	10
Anchor length	$l$ [mm]	20	32	38	45	38	52	65
Anchor neck length	$h$ [mm]	4	6	12,5	19	8	12,5	25
Screw length	$l_s \geq$ [mm]	25	39	45	52	45	58	71
Screw diameter	$d$ [mm]	M4	M4	M4	M4	M5	M5	M5
Panel thickness	$h_{min,max}$ [mm]	3 - 4	6 - 7	10 - 13	18 - 20	6 - 8	11 - 13	23 - 25
Max. fixable thickness for pre-setting	$t_{fix}$ [mm]	15	25	25	25	25	30	30

### Setting details HHD-S

Anchor		M6x9	M6x12	M6x24	M6x40	M8x12	M8x24	M8x40
Nominal diameter of drill	$d_o$ [mm]	12	12	12	12	12	12	12
Anchor length	$l$ [mm]	38	52	65	80	54	66	83
Anchor neck length	$h$ [mm]	9	12,5	25	40	12,5	25	40
Screw length	$l_s \geq$ [mm]	45	58	71	88	60	72	90
Screw diameter	$d$ [mm]	M6	M6	M6	M6	M8	M8	M8
Panel thickness	$h_{min,max}$ [mm]	7 - 9	11 - 13	23 - 25	38 - 40	11 - 13	23 - 25	38 - 40
Max. fixable thickness for pre-setting	$t_{fix}$ [mm]	20	30	30	30	30	30	35

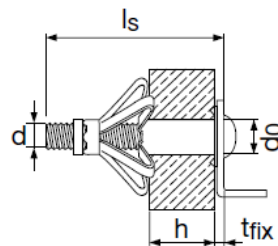

### Installation equipment

Anchor	M4	M5	M6	M8
Rotary hammer	TE2 - TE16			
Other tools	Screwdriver, HHD-SZ2 expansion tool			

### Setting instruction

\*For detailed information on installation see instruction for use given with the package of the product.

#### Setting instructions

##### 1. Drill hole with drill bit

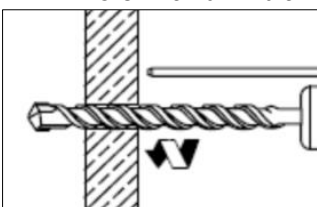

##### 2. Put anchor into setting tool

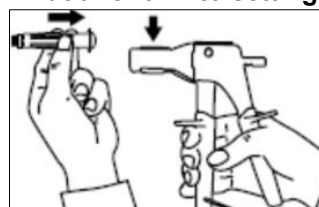

##### 3. Install anchor with setting tool

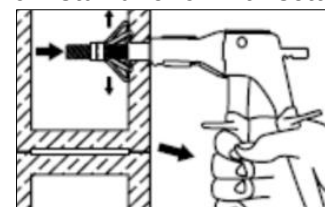

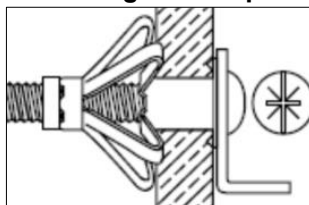
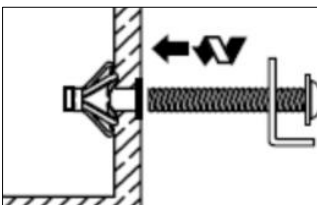

##### 4. Remove screw from anchor and screw in gain with part being fastened attached



# HSP / HFP Light duty metal anchors

## Metal drywall anchor

Anchor version		Benefits
	HSP (-S)	<ul style="list-style-type: none"> <li>- For light fastenings on drywall panel</li> <li>- Self-cutting</li> <li>- Quick setting</li> </ul>
	HFP (-S)	

Base material

Drywall

**Basic loading data**

**All data in this section applies to:**

- Correct setting (See setting instruction)
- No edge distance and spacing influence
- Base material as specified in the table

**Recommended loads <sup>a)</sup>**

Gypsum board thickness		12,5 mm	2 x 12,5 mm
Tensile N <sub>Rec</sub>	HSP (-S) [kN]	0,06	0,12
	HFP (-S) [kN]	0,06	0,12
Shear V <sub>Rec</sub>	HSP (-S) [kN]	0,18	0,27
	HFP (-S) [kN]	0,18	0,27

a) With overall global safety factor  $\gamma = 3$  to the characteristic load.

**Materials**

Material quality	Material
Part	
HSP (-S)	Polyamide, fibre reinforced
HFP (-S)	Zinc die-casting
Screw	Carbon steel, galvanised to min. 5µm

## Setting information

### Installation equipment

Anchor	HSP (-S) / HFP (-S)
Rotary hammer	-
Other tools	Screwdriver with D-B PH2 HSP/HFP duo-bit

### Setting details HSP (-S) / HFP (-S)

Anchor		HSP (-S)	HFP (-S)
Max fixture thickness	$t_{fix}$	13	13
Anchor length	$l$	37	37
Screw length	$l_s$	19 + $t_{fix}$	
Screw diameter $\phi$	$d$	4,5	4,5

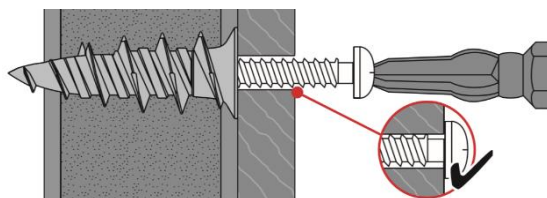
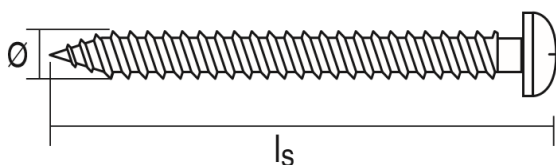

### Setting instruction

\*For detailed information on installation see instruction for use given with the package of the product.

### Setting instructions

#### Drive in plug

##### 1. Drive in the plug

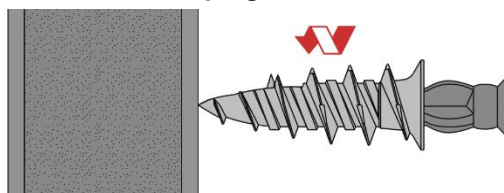

##### 2. Drive in the plug

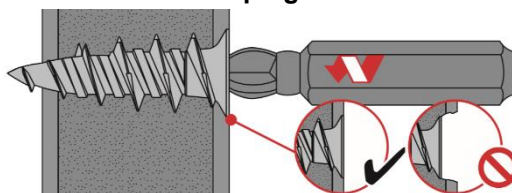

#### Fasten part and drive in screw

##### 3. Fasten part and drive in screw

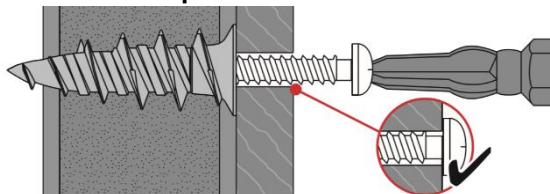

# HA 8 NG Light duty metal anchors

## Hook and ring anchor

### Anchor version



HA 8 NG R1



HA 8 NG H1

### Benefits

- Well proven
- Easy-setting
- Follow-up expansion
- Hook and ring head available

### Base material



Concrete  
(non-cracked)

### Load conditions

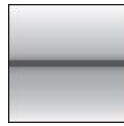

Static/  
quasi-static

### Installation conditions



Hammer  
drilled holes

### Basic loading data (for a single anchor)

**All data in this section applies to:**

- Correct setting (See setting instruction)
- No edge distance and spacing influence
- Values are only valid for tensile loading
- Concrete C20/25 to C50/60

Concrete		Non-cracked
Tensile $N_{rec}$	[kN]	0,8

### Materials

Anchor size		HA 8 NG bolt
Nominal tensile strength	$f_{uk}$ [N/mm <sup>2</sup> ]	520
Yield strength	$f_{yk}$ [N/mm <sup>2</sup> ]	450

### Material quality

Part	Material
Expansion sleeve	Carbon steel, galvanized to min. 5 $\mu$ m
Bolt	Carbon steel, galvanized to min. 5 $\mu$ m

### Anchor dimensions

Anchor size		HA 8 NG
Bolt diameter	$d_R$ [mm]	5.4
Length of the anchor	$l_1$ [mm]	76

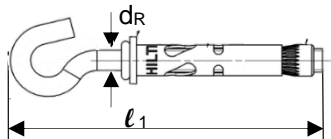

## Setting information

### Setting details

Anchor size		HA 8 NG
Nominal diameter of drill bit	$d_o$ [mm]	8
Cutting diameter of drill bit	$d_{cut} \leq$ [mm]	8,45
Depth of drill hole	$h_1 \geq$ [mm]	55
Effective anchorage depth	$h_{ef}$ [mm]	35

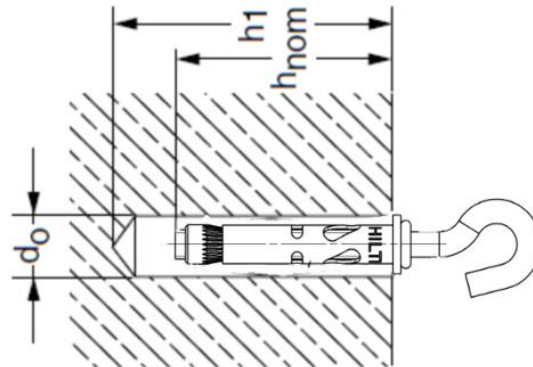

### Installation equipment

Anchor size		HA 8 NG
Rotary hammer		TE2 – TE16
Other tools		Hammer, blow out pump

### Setting parameters

Anchor size		HA 8 NG
Minimum base material thickness	$h_{min}$ [mm]	100
Minimum spacing	$s$ [mm]	200
Minimum edge distance	$c$ [mm]	100
Minimum edge distance at the corner	$c_e$ [mm]	150

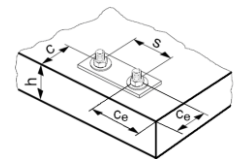

### Setting instruction

\*For detailed information on installation see instruction for use given with the package of the product.

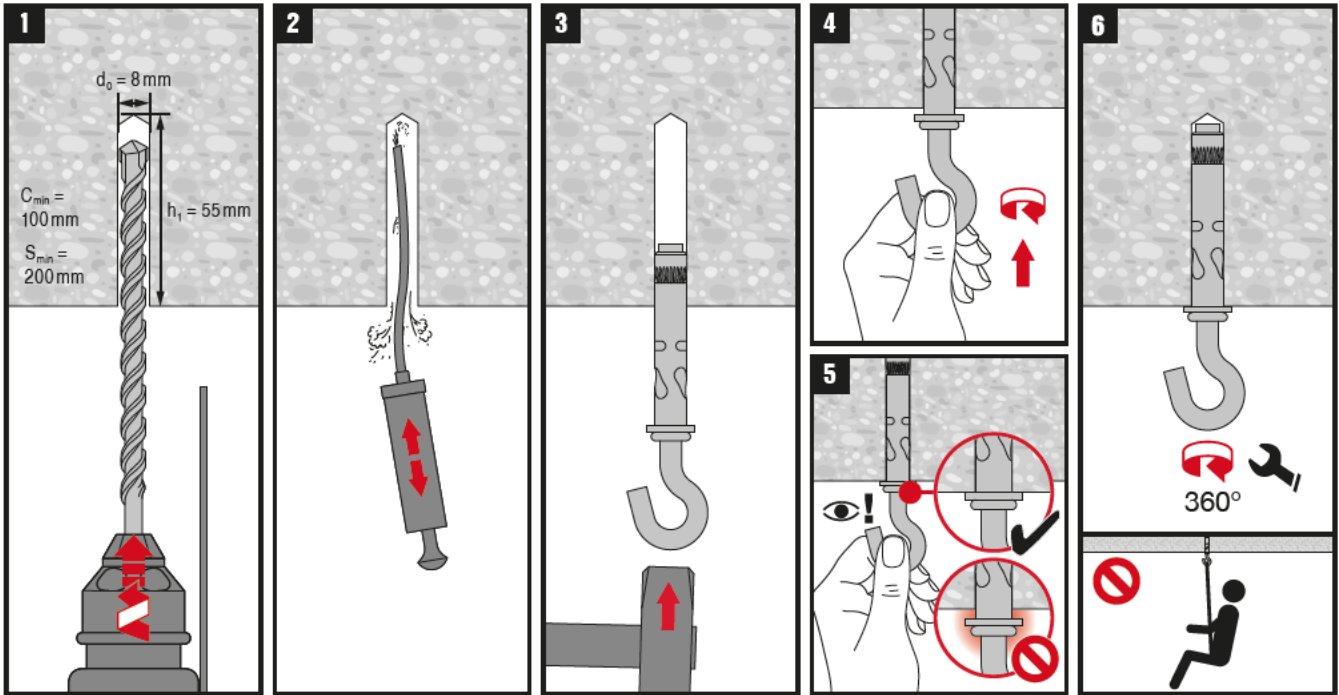



# HTB Light duty metal anchors

Economical metal anchor for drywall and hollow wall

## Anchor version



HTB  
(M5-M6)

## Benefits

- Ingenious and strong for hollow base materials
- Convincing simplicity when setting
- Technical superiority with up to 92 mm fixing thickness
- Load carried by strong metal channel and screw

## Base material



Drywall

## Basic loading data

All data in this section applies to:

- Correct setting (See setting instruction)
- No edge distance and spacing influence
- Base material as specified in the table
- Minimum base material thickness

### Characteristic resistance

Anchor size		M5	M6
Gypsum board Thickness 10 mm	N <sub>Rk</sub> [kN]	0,75	
	V <sub>Rk</sub> [kN]	0,45	
Gypsum board Thickness 12,5 mm	N <sub>Rk</sub> [kN]	1,20	
	V <sub>Rk</sub> [kN]	0,90	
Gypsum board Thickness 2x12,5 mm	N <sub>Rk</sub> [kN]	2,10	
	V <sub>Rk</sub> [kN]	0,90	
Fibre reinforced gypsum board Thickness 10 mm	N <sub>Rk</sub> [kN]	1,20	
	V <sub>Rk</sub> [kN]	1,80	
Fibre reinforced gypsum board Thickness 12,5 mm	N <sub>Rk</sub> [kN]	1,80	
	V <sub>Rk</sub> [kN]	3,00	
Hollow decks Cavity to surface thickness ≥ 30,0 mm	N <sub>Rk</sub> [kN]	1,50	
	V <sub>Rk</sub> [kN]	-	
Hollow brick "Parpaing Creux B40"	N <sub>Rk</sub> [kN]	1,35	
	V <sub>Rk</sub> [kN]	2,70	

### Design resistance

Anchor size			M5	M6
Gypsum board Thickness 10 mm	$N_{Rd}$	[kN]	0,35	
	$V_{Rd}$	[kN]	0,21	
Gypsum board Thickness 12,5 mm	$N_{Rd}$	[kN]	0,56	
	$V_{Rd}$	[kN]	0,42	
Gypsum board Thickness 2x12,5 mm	$N_{Rd}$	[kN]	0,98	
	$V_{Rd}$	[kN]	0,42	
Fibre reinforced gypsum board Thickness 10 mm	$N_{Rd}$	[kN]	0,56	
	$V_{Rd}$	[kN]	0,84	
Fibre reinforced gypsum board Thickness 12,5 mm	$N_{Rd}$	[kN]	0,84	
	$V_{Rd}$	[kN]	1,40	
Hollow decks Cavity to surface thickness $\geq 30,0$ mm	$N_{Rd}$	[kN]	0,70	
	$V_{Rd}$	[kN]	-	
Hollow brick "Parpaing Creux B40"	$N_{Rd}$	[kN]	0,63	
	$V_{Rd}$	[kN]	1,26	

### Recommended loads<sup>a)</sup>

Anchor size			M5	M6
Gypsum board Thickness 10 mm	$N_{Rec}$	[kN]	0,25	
	$V_{Rec}$	[kN]	0,15	
Gypsum board Thickness 12,5 mm	$N_{Rec}$	[kN]	0,40	
	$V_{Rec}$	[kN]	0,30	
Gypsum board Thickness 2x12,5 mm	$N_{Rec}$	[kN]	0,70	
	$V_{Rec}$	[kN]	0,30	
Fibre reinforced gypsum board Thickness 10 mm	$N_{Rec}$	[kN]	0,40	
	$V_{Rec}$	[kN]	0,60	
Fibre reinforced gypsum board Thickness 12,5 mm	$N_{Rec}$	[kN]	0,60	
	$V_{Rec}$	[kN]	1,00	
Hollow decks Cavity to surface thickness $\geq 30,0$ mm	$N_{Rec}$	[kN]	0,50	
	$V_{Rec}$	[kN]	-	
Hollow brick "Parpaing Creux B40"	$N_{Rec}$	[kN]	0,45	
	$V_{Rec}$	[kN]	0,90	

a) With overall global safety factor  $\gamma = 3$  to the characteristic loads and a partial safety factor of  $\gamma = 1,4$ , to the design values.

### Materials

#### Material quality

Part	Material
Metal channel	Carbon steel galvanized to 5 microns
Cap washer	Polypropylene copolymer
Legs	High impact polystyrene
Screw	Carbon steel galvanized to 3 microns

## Setting information

### Setting details

Anchor size			M5	M6
Nominal diameter of drill bit	$d_o$	[mm]	13 - 14	
Thickness of wall and fixture	min	$h + t_{fix}$	10	
	max	$h + t_{fix}$	92	
Minimum space of cavity	$l$	[mm]	48	
Screw length	$l$		$12 + h + t_{fix}$	
Screw size	$d$	[Nm]	M5	M6
Torque moment	$T_{inst}$	[mm]	3	5

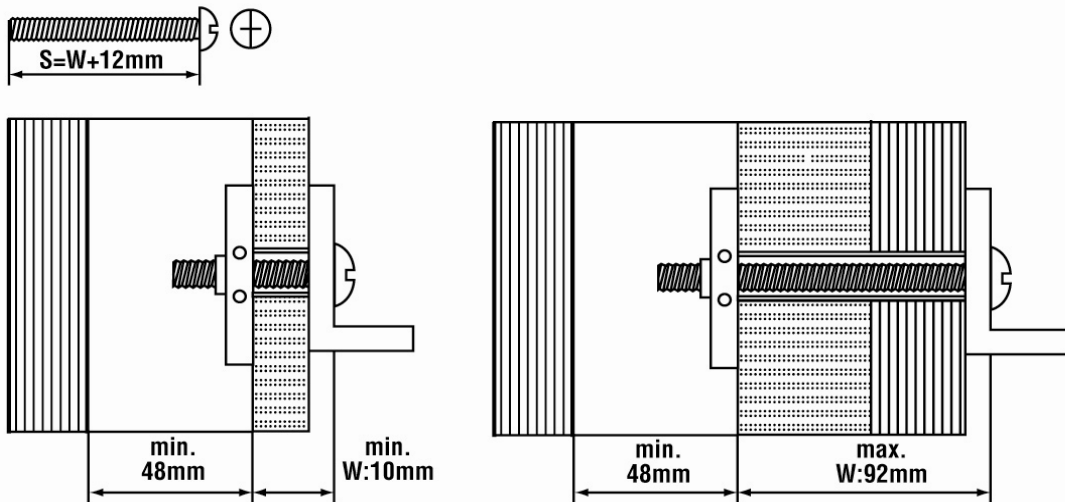

### Installation equipment

Anchor size	M5	M6
Rotary hammer	TE 6A, TE 6C, TE 6S, TE 15, TE 15-C, TE 18-M	
Setting tools	Torque wrench	
Machine setting tool	available	

### Setting instruction

\*For detailed information on installation see instruction for use given with the package of the product.

Setting instruction		
<b>1. Drilling</b> 	<b>2. Inserting anchor in the hole</b> 	<b>3. Adjusting anchor</b> 
<b>4. Adjusting anchor</b> 	<b>5. Throw away removable part</b> 	<b>6. Inserting screw with tool</b> 



# HIF Insulation fastener

## Anchor version



HIF

## Benefits

- Especially for soft insulation material
- Plate diameter 90mm is ideal not to sink in the surface
- No slip-on plate must be used
- Drilling, hammering, done
- Speed due to less drilling effort
- With anchors up to 240mm insulation thickness the whole application is covered

## Base material



Concrete (non-cracked)

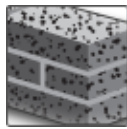

Solid brick

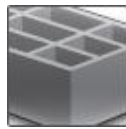

Hollow brick

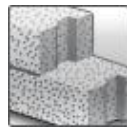

Autoclaved aerated concrete

## Other information

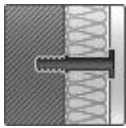

Fastening of insulation at the wall only

## Basic loading data (for a single anchor)

### All data in this section applies to:

- Correct setting (see setting instruction)
- No edge distance and spacing influence
- Base material as specified in table
- Minimum base material thickness
- Tensile loads only

## Recommended loads

Base material		HIF
Concrete $\geq$ C16/20	$N_{Rd}$ [kN]	0,03
Solid clay brick Mz 20 – 1,8 – NF	$N_{Rd}$ [kN]	0,03
Solid sand-lime brick KS 12 – 1,6 – 2DF	$N_{Rd}$ [kN]	0,03
Hollow clay brick <sup>c)</sup> Hz 12 – 0,8 – 6DF	$N_{Rd}$ [kN]	0,025 <sup>b)</sup>
Hollow sand-lime brick <sup>c)</sup> KSL 12 – 1,4 – 3DF	$N_{Rd}$ [kN]	0,03
Autoclaved aerated concrete AAC 4	$N_{Rd}$ [kN]	0,015 <sup>b)</sup>

a) Recommended loads  $N_{rec}$  are based on an global safety factor  $\gamma = 3$  to the characteristic resistance. Design resistance  $N_{Rd}$  can be derived by multiplying  $N_{rec}$  with a partial safety factor of  $\gamma_F = 1,5$ .

b) Drilling without hammer action

c) Thickness of web for Hz  $\geq$  18mm, for KSL  $\geq$  25mm

### Point thermal transmittance

Base material	Point thermal transmittance $\chi$ [W/K]
Insulation	0,000 <sup>a)</sup>

a) According EOTA Technical Report TR 025

### Fire classification

According to	Classification
DIN 4102	B2
EN 13501-1	E-d2

### Service temperature range

	Base material temperature	Maximum long term base material temperature	Maximum short term base material temperature
Temperature range	-40 °C to +40 °C	+24 °C	+40 °C

### Maximum short term base material temperature

Short-term elevated base material temperatures are those that occur over brief intervals, e.g. because of diurnal cycling.

### Maximum long term base material temperature

Long-term elevated base material temperatures are roughly constant over significant periods of time.

## Materials

### Material quality

Part	Material
Anchor shaft and anchor plate	Polypropylene

## Setting information

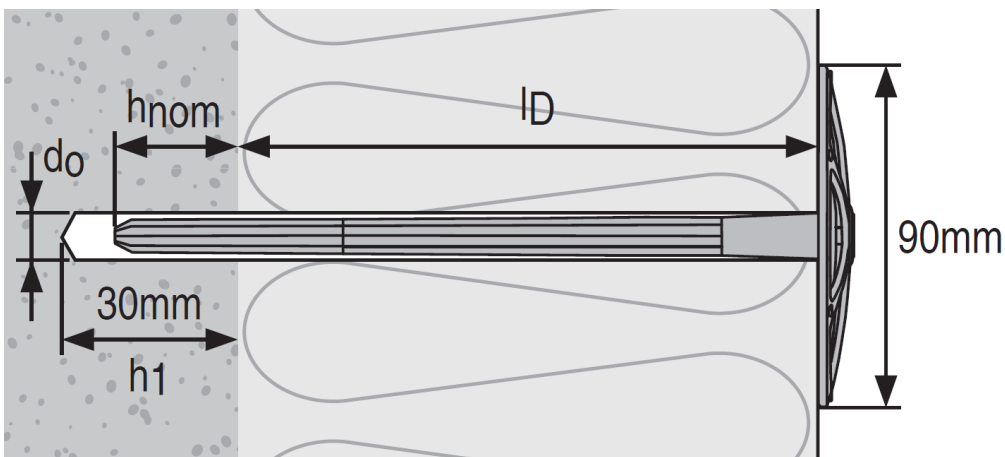

## Setting details

HIF	60	80	100	120	140	160	180	200	220	240
Nominal diameter of drill bit $d_0$ [mm]	8									
Cutting diameter of drill bit $d_{cut} \leq$ [mm]	8,45									
Depth of drill hole $h_1 \geq$ [mm]	$L_a - l_D + 5$ $\geq 30\text{mm}$									
Overall plastic anchor embedment depth in the base material $h_{nom} \geq$ [mm]	25									
Anchor length $L_a$ [mm]	85	105	125	145	165	185	205	225	245	265
Fixture thickness $l_D$ [mm]	40-60	60-80	80-100	100-120	120-140	140-160	160-180	180-200	200-220	220-240
Installation temperature [°C]	0 to +40									
Exposure to UV	$\leq 6$ weeks									

## Installation equipment

Anchor size	HIF
Rotary hammer	Corded: HILTI TE 2 – TE 7 Battery: HILTI TE2-A22, TE4-A22, TE6-A36
Other tools	Hammer

## Setting parameters

HIF	60	80	100	120	140	160	180	200	220	240
Minimum base material thickness $h_{min}$ [mm]	100									
Minimum spacing $s_{min}$ [mm]	100									
Minimum edge distance $c_{min}$ [mm]	100									

## Setting instruction\*

\*For detailed information on installation see instruction for use given with the package of the product.

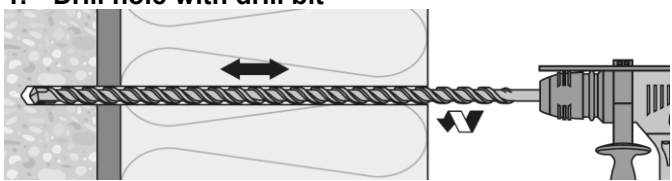
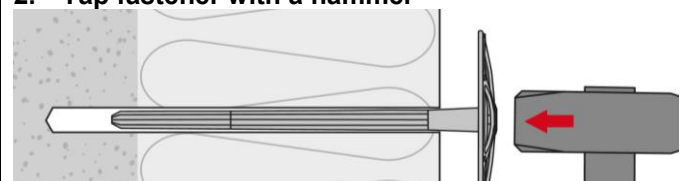
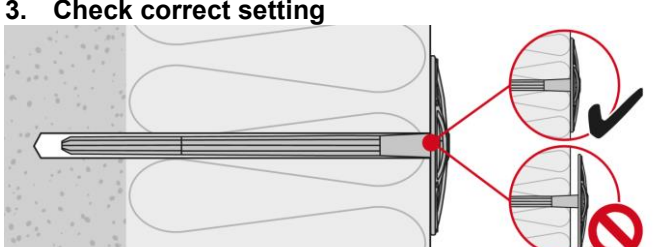
Setting instructions	
<p><b>1. Drill hole with drill bit</b></p> 	<p><b>2. Tap fastener with a hammer</b></p> 
<p><b>3. Check correct setting</b></p> 	





Chemical anchors

Mechanical anchors

Plastic/Light duty metal anchors

Insulation anchors

# HTH Insulation fastener

## Anchor version



HTH

## Benefits

- Fastening in all base materials of category A, B, C, D and E
- Setting tool for fast and safe application
- Lowest heat transmission (chi-value up to 0.000 W/K)
- One anchor size fits all insulation thickness

## Base material



Concrete (non-cracked)

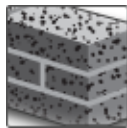

Solid brick

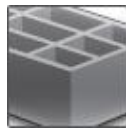

Hollow brick

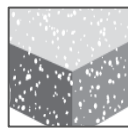

Lightweight Aggregate concrete

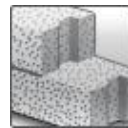

Autoclavated Aerated concrete

## Other information

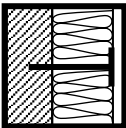

Fastening of insulation at the wall only



European Technical Assessment



CE conformity

## Approvals/Certificates

Description	Authority / Laboratory	No. / date of issue
European Technical Assessment <sup>a)</sup>	DIBt, Berlin	ETA-15/0464 / 2018-01-11
Application in External Thermal Insulation Composite Systems with Rendering <sup>a)</sup>	DIBt, Berlin	Z-21.2-2047 / 2018-04-13

a) Unless otherwise stated, all data given in this section are according to named documents

## Basic loading data (for a single anchor)

### All data in this section applies to:

- Correct setting (see setting instruction)
- No edge distance and spacing influence
- Base material as specified in table
- Minimum base material thickness
- Transmission of wind suction loads only

### Characteristic resistance

Base material	Use cat. <sup>d)</sup>		HTH
Concrete ≥ C12/15	A	N <sub>Rk</sub> [kN]	1,2
Thin concrete members (e.g. weather resistant skins of external wall panels) C16/20 – C 50/60	A	N <sub>Rk</sub> [kN]	1,2
Solid clay brick Mz 20/2,0	B	N <sub>Rk</sub> [kN]	1,2
Solid sand-lime brick KS 20/2,0	B	N <sub>Rk</sub> [kN]	1,2
Vertically perforated clay brick Hz 12/1,2	C	N <sub>Rk</sub> [kN]	1,2 <sup>a)</sup>
Vertically perforated clay brick Hz 12/0,8	C	N <sub>Rk</sub> [kN]	0,6 <sup>b)</sup>
Vertically perforated sand-lime brick KSL 12/1,4	C	N <sub>Rk</sub> [kN]	1,2 <sup>c)</sup>
Lightweight Aggregate Concrete ≥ LAC2 (raw density ≥ 0,9 kg/dm <sup>3</sup> )	D	N <sub>Rk</sub> [kN]	0,6
Lightweight Aggregate Concrete ≥ LAC4 (raw density ≥ 0,9 kg/dm <sup>3</sup> )	D	N <sub>Rk</sub> [kN]	1,2
Autoclaved aerated concrete ≥ PP4 (raw density ≥ 0,5 kg/dm <sup>3</sup> )	E	N <sub>Rk</sub> [kN]	0,9

a) The value applies only for outer web thickness ≥ 12 mm, rotary drilling only

b) The value applies only for outer web thickness ≥ 9 mm, rotary drilling only

c) The value applies only for outer web thickness ≥ 23 mm, rotary drilling only

d) Different installation parameters for use categories A, B, C and use categories D, E and thin concrete members to be considered

### Design resistance

Design resistance was calculated according to equation:

$$N_{Rd} = \frac{N_{Rk}}{\gamma_M} \text{ with } \gamma_M = 2,0 \text{ (safety factor for base material)}$$

Base material	Use cat. <sup>d)</sup>		HTH
Concrete ≥ C12/15	A	N <sub>Rd</sub> [kN]	0,6
Thin concrete members (e.g. weather resistant skins of external wall panels) C16/20 – C 50/60	A	N <sub>Rd</sub> [kN]	0,6
Solid clay brick Mz 20/2,0	B	N <sub>Rd</sub> [kN]	0,6
Solid sand-lime brick KS 20/2,0	B	N <sub>Rd</sub> [kN]	0,6
Vertically perforated clay brick Hz 12/1,2	C	N <sub>Rd</sub> [kN]	0,6 <sup>a)</sup>
Vertically perforated clay brick Hz 12/0,8	C	N <sub>Rk</sub> [kN]	0,3 <sup>b)</sup>
Vertically perforated sand-lime brick KSL 12/1,4	C	N <sub>Rd</sub> [kN]	0,6 <sup>c)</sup>
Lightweight Aggregate Concrete ≥ LAC2 (raw density ≥ 0,9 kg/dm <sup>3</sup> )	D	N <sub>Rd</sub> [kN]	0,3
Lightweight Aggregate Concrete ≥ LAC4 (raw density ≥ 0,9 kg/dm <sup>3</sup> )	D	N <sub>Rd</sub> [kN]	0,6
Autoclaved aerated concrete ≥ PP4 (raw density ≥ 0,5 kg/dm <sup>3</sup> )	E	N <sub>Rd</sub> [kN]	0,45

a) The value applies only for outer web thickness ≥ 12 mm, rotary drilling only

b) The value applies only for outer web thickness ≥ 9 mm, rotary drilling only

c) The value applies only for outer web thickness ≥ 23 mm, rotary drilling only

d) Different installation parameters for use categories A, B, C and use categories D, E and thin concrete members to be considered

## Recommended loads

Recommended load was calculated according to equation:

$$N_{Rd} = \frac{N_{Rd}}{\gamma_F} \text{ with } \gamma_F = 1,5 \text{ (safety factor for wind)}$$

Base material	Use cat. <sup>d)</sup>		HTH
Concrete ≥ C12/15	A	N <sub>Rd</sub> [kN]	0,4
Thin concrete members (e.g. weather resistant skins of external wall panels) C16/20 – C 50/60	A	N <sub>Rd</sub> [kN]	0,4
Solid clay brick Mz 20/2,0	B	N <sub>Rd</sub> [kN]	0,4
Solid sand-lime brick KS 20/2,0	B	N <sub>Rd</sub> [kN]	0,4
Vertically perforated clay brick Hlz 12/1,2	C	N <sub>Rd</sub> [kN]	0,4 <sup>a)</sup>
Vertically perforated clay brick Hlz 12/0,8	C	N <sub>Rk</sub> [kN]	0,2 <sup>b)</sup>
Vertically perforated sand-lime brick KSL 12/1,4	C	N <sub>Rd</sub> [kN]	0,4 <sup>c)</sup>
Lighweight Aggregate Concrete ≥ LAC2 (raw density ≥ 0,9 kg/dm <sup>3</sup> )	D	N <sub>Rd</sub> [kN]	0,2
Lighweight Aggregate Concrete ≥ LAC4 (raw density ≥ 0,9 kg/dm <sup>3</sup> )	D	N <sub>Rd</sub> [kN]	0,4
Autoclaved aerated concrete ≥ PP4 (raw density ≥ 0,5 kg/dm <sup>3</sup> )	E	N <sub>Rd</sub> [kN]	0,3

a) The value applies only for outer web thickness ≥ 12 mm, rotary drilling only

b) The value applies only for outer web thickness ≥ 9 mm, rotary drilling only

c) The value applies only for outer web thickness ≥ 23 mm, rotary drilling only

d) Different installation parameters for use categories A, B, C and use categories D, E and thin concrete members to be considered

## Insulation Materials

Insulation material and provider	Specifying document	Referenced document for anchor design	Design provisions <sup>a)</sup>	Anchor design
EPS with designation key T2 L2 W2 S2 P4 BS50 DS(70)5-DS(N)2 a) TR80 raw density 15-20 kg/m <sup>3</sup> ; b) TR100 raw density 15-30 kg/m <sup>3</sup>	DIN EN 13163	Z-21.2-2047 April 13 <sup>th</sup> 2018, DIBt	ETICS fixed with anchor and supplementary adhesive Panels 100mm to 360mm thick	see next pages <sup>b)</sup>
Coverrock, Coverrock II and Coverrock 036 by Deutsche Rockwool Mineralwoll GmbH	Z-33.4-1571, October 14 <sup>th</sup> 2016, DIBt			
Sillatherm WVP 1-035 by SAINT-GOBAIN ISOVER G+H AG	Z-33.4-1081, Oct. 14 <sup>th</sup> 2016, DIBt			
Mineral wool FKD-MAX C1/C2 by Knauf Insulation GmbH	Anwendungs-dokument <sup>b)</sup>	Anwendungs-dokument <sup>c)</sup>	ETICS fixed with anchor and supplementary adhesive Panels 100mm to 200mm thick	see next pages
Mineral wool FKD-S C2 by Knauf Insulation GmbH	ÖNorm B6000:2017	B6400-1, September 2017		Systemklasse 3
Mineral wool PAROC FAS 3cc by PAROC GmbH				
Mineral wool ROCKWOOL PT A 036 by ROCKWOOL Handelsgesellschaft m.b.H.				

- a) Design provisions of this table refer to the referenced documents for anchor design. National provisions of other countries might be different and must be considered.
- b) In Germany: Design provisions of German ETICS-approval Z-33.43-xxxx must be considered, too. The less unfavourable design of Z-21.2-2047 and Z-33.43-xxxx is applicable.
- c) Anwendungsdokument Mineralwolle-Dämmstoff nach EN 16262 für die Verwendung in Wärmedämmverbundsystemen (WDVS), Knauf Insulation Putzträgerplatte FKD-MAX C1, Knauf Insulation Putzträgerplatte FKD-MAX C2, Knauf Insulation GmbH, November 2017

In absence of national provisions, HTH can be used for ETICS with mineral wool if the following provision are kept:

- minimum 4 anchors/m<sup>2</sup>
- only ETICS fixed with anchors and supplementary adhesive
- only ETICS that hold an ETA or National approval
- Mineral wool of TR5 or greater
- Mineral wool of 100mm to 300mm thickness
- Rendering weight ≤ 48 kg/m<sup>2</sup>
- Characteristic pull-through resistance of the mineral wool in combination with HTH has to be determined by tests
- Design of anchor number/m<sup>2</sup> must be done based on characteristic pull-through resistance and pull-out resistance by an engineer experienced in anchor design

Number of anchors based on design wind resistance  $w_{ed}=w_e \cdot \gamma_F$  for different insulation panels and base material categories A, B, C, D, E <sup>a) b) c)</sup>

Design load of wind $w_{ed}$ [kN/m <sup>2</sup> ] <sup>e)</sup>				Number of anchors per m <sup>2</sup>	Anchor pattern <sup>f)</sup>
EPS TR80	EPS TR100	Coverrock, Coverrock II and Coverrock 036	Sillatherm WVP 1-035		
Panel size: 1000mm x 500mm		Panel size: 800mm x 625mm			
≤ 1,2	≤ 1,3	≤ 0,6	≤ 0,3	4	
≤ 1,7	≤ 1,9	≤ 0,8	≤ 0,4	6	
≤ 2,2	≤ 2,4	≤ 1,1	≤ 0,6	8	
≤ 2,6	≤ 2,9	≤ 1,2	≤ 0,7	10	
≤ 3,0	≤ 3,3	≤ 1,4	-	12	
-	-	≤ 1,5	-	14	

- a) The design of anchorages must be carried out in accordance to ETAG 014 and ETAG 004 under the responsibility of an engineer experienced in anchorages.
- b) The table considers a safety factor for the base material of  $\gamma_{M,BM}=2,0$ , for EPS  $\gamma_{M,EPS}=1,5$ , and for mineral wool  $\gamma_{M,MW}=2,0$ .
- c) All base materials given in tables before are covered. In case that the characteristic resistance is determined by job site tests, the number of anchors is determined by the greater number in the table and  $n = w_{ed}/(N_{rk,job\ site}/\gamma_{M,BM})$ , where  $N_{rk,job\ site}$ =characteristic resistance determined by job site tests and  $\gamma_{M,BM}=2,0$  (in absence of national safety factors). The number n shall be rounded upwards to an integer number.
- d) DIBt letter November 13<sup>th</sup>, 2017 lays out that ETICS anchor approvals do cover wind resistances only. Effects caused by ETICS' weight and hygrothermal influences are not considered. In every case the ETICS approval must be considered.
- e)  $w_{ed}=w_e \times \gamma_F$  where  $w_e$ =characteristic external wind suction according EN 1991-1-4:2005-04 and national appendixes. Safety factor for wind  $\gamma_F=1,5$ .
- f) The application of the indicated anchor pattern pre-assumes that the anchors are set with a distance  $\geq 150$ mm to the edge of the panels

Chemical anchors

Mechanical anchors

Plastic/Light duty metal anchors

Insulation anchors

**Number of anchors based on design wind loads  $w_e$  for different insulation panels and base material categories A, B, C, D, E a) b) c) d)**

wind load $w_{ed}$ [kN/m <sup>2</sup> ] <sup>e)</sup>				Number of anchors per m <sup>2</sup>	Anchor pattern <sup>f)</sup>
EPS TR80	EPS TR100	Coverrock, Coverrock II and Coverrock 036	Sillatherm WVP 1-035		
Panel size: 1000mm x 500mm		Panel size: 800mm x 625mm			
≤ 0,80	≤ 0,87	≤ 0,40	≤ 0,20	4	
≤ 1,13	≤ 1,27	≤ 0,53	≤ 0,27	6	
≤ 1,47	≤ 1,60	≤ 0,73	≤ 0,40	8	
≤ 1,73	≤ 1,93	≤ 0,80	≤ 0,47	10	
≤ 2,00	≤ 2,20	≤ 0,93	-	12	
-	-	≤ 1,00	-	14	

- a) The design of anchorages must be carried out in accordance to ETAG 014 and ETAG 004 under the responsibility of an engineer experienced in anchorages.
- b) The table considers a safety factor for the base material of  $\gamma_{M,BM}=2,0$ , for EPS  $\gamma_{M,EPS}=1,5$ , for mineral wool  $\gamma_{M,MW}=2,0$  and for wind action  $\gamma_F=1,5$
- c) All base materials given in tables before are covered. In case that the characteristic resistance is determined by job site tests, the number of anchors is determined by the greater number in the table and  $n = w_e / (N_{rk,job\ site} / (\gamma_{M,BM} \times \gamma_F))$ , where  $N_{rk,job\ site}$ =characteristic resistance determined by job site tests,  $\gamma_{M,BM}=2,0$  and  $\gamma_F=1,50$  (in absence of national safety factors). The number n shall be rounded upwards to an integer number.
- d) DIBt letter November 13<sup>th</sup>, 2017 lays out that ETICS anchor approvals do cover wind resistances only. Effects caused by ETICS' weight and hygrothermal influences are not considered. In every case the ETICS approval must be considered.
- e)  $w_e$ =characteristic external wind suction according EN 1991-1-4:2005-04 and national annexes
- f) The application of the indicated anchor pattern pre-assumes that the anchors are set with a distance  $\geq 150$ mm to the edge of the panels



**Number of anchors based on wind loads  $w_e$  for FKD-MAX panels, size 1200mm x 400mm and base material categories A, B, C, D, E <sup>a) b) c) d)</sup>**

wind load $w_e$ [kN/m <sup>2</sup> ] <sup>e)</sup>	Number of anchors per m <sup>2</sup>	Anchor pattern <sup>f)</sup>
FKD-MAX		
Panel size: 1200mm x 400mm		
$\leq 0,50$	6	
$\leq 0,60$	7	
$\leq 0,70$	8	
$\leq 0,80$	9	
$\leq 0,90$	10	
$\leq 1,0$	11	
$\leq 1,12$	12	

- a) The design of anchorages must be carried out in accordance to ETAG 014 and ETAG 004 under the responsibility of an engineer experienced in anchorages.
- b) The table considers a safety factor for the base material of  $\gamma_{M,BM}=2,0$ , for EPS  $\gamma_{M,EPS}=1,5$ , for mineral wool  $\gamma_{M,MW}=2,0$  and for wind action  $\gamma_F=1,5$
- c) All base materials given in tables before are covered. In case that the characteristic resistance is determined by job site tests, the number of anchors is determined by the greater number in the table and  $n = w_e / (N_{rk,job\ site} / (\gamma_{M,BM} \times \gamma_F))$ , where  $N_{rk,job\ site}$ =characteristic resistance determined by job site tests,  $\gamma_{M,BM}=2,0$  and  $\gamma_F=1,50$  (in absence of national safety factors). The number n shall be rounded upwards to an integer number.
- d) DIBt letter November 13<sup>th</sup>, 2017 lays out that ETICS anchor approvals do cover wind resistances only. Effects caused by ETICS' weight and hygrothermal influences are not considered. In every case the ETICS approval must be considered.
- e)  $w_e$ =characteristic external wind suction according EN 1991-1-4:2005-04 and national annexes
- f) The application of the indicated anchor pattern pre-assumes that the anchors are set with a distance  $\geq 150$ mm to the edge of the panels

**Point Thermal Transmittance**

Anchor size		HTH 8x125	HTH 8x155
Point thermal transmittance $\chi$	[W/K]	0,001 ( $t_{fix}= 80$ mm, $100$ mm $\leq h_D \leq 150$ mm)	0,000 ( $t_{fix}= 80$ mm, $150$ mm $< h_D \leq 360$ mm)

**Plate stiffness and plate capacity <sup>a) b)</sup>**

Anchor size		HTH 8x125	HTH 8x155
Capacity of plate	[kN]	1,80	
Plate stiffness	[kN/mm]	0,70	

- a) Test report DET 15-008, HILTI corporation, Schaan (LI), 13.04.2015, testing in accordance with EOTA-TR026, 06.2007
- b) The data are related to the performance of the helix-shaped insulation holder of HTH. The naming plate stiffness and plate capacity were kept because that is the common nomenclature.

Chemical anchors  
Mechanical anchors  
Plastic/Light duty metal anchors  
Insulation anchors

Hilti HTH ETICS anchors may be applied in the temperature range given below.

### Service temperature range

	Base material temperature	Maximum long term base material temperature	Maximum short term base material temperature
Temperature range	0 °C to +40 °C	+24 °C	+40 °C

### Maximum short term base material temperature

Short-term elevated base material temperatures are those that occur over brief intervals, e.g. as a result of diurnal cycling.

### Maximum long term base material temperature

Long-term elevated base material temperatures are roughly constant over significant periods of time.

## Materials

### Material quality

Part	Material
Anchor sleeve	Polypropylene, black
Expansion screw	Steel, galvanized
Plug	EPS
PU-Foam	Polyurethane, thermal conductivity $\leq 0,045$ W/(mK)

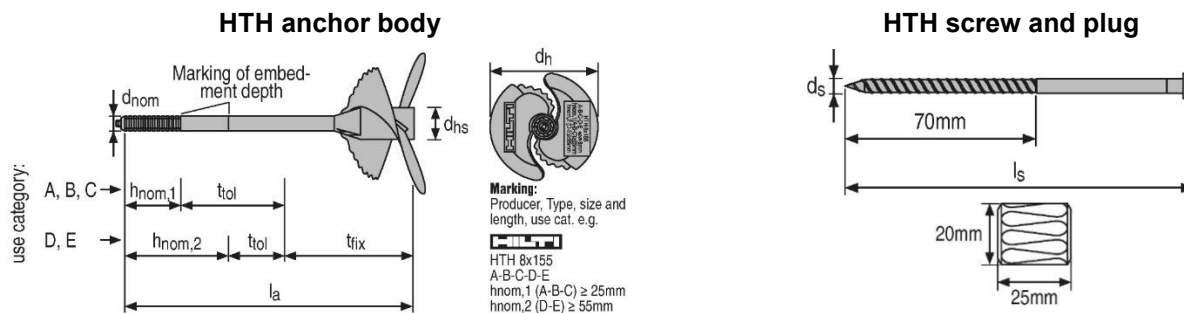

### Anchor size

		HTH 8x125	HTH 8x155
Diameter of sleeve	$d_{nom}$ [mm]	8	
Length of sleeve	$l_a$ [mm]	125	125
Diameter of helix center	$d_{hs}$ [mm]	17	
Diameter of helix	$d_h$ [mm]	75	
Screw diameter	$d_s$ [mm]	5,35	
Length of screw	$l_s$ [mm]	94	94

### Anchor designations

		HTH
Anchor sleeve	Top of helix	Producer: HILTI Anchor type: HTH Size and length [mm]: e.g. 8x155 Use categories (base materials): A-B-C-D-E Overall embedment depth in use categories A, B and C: $h_{nom,1} (A-B-C) \geq 25\text{mm}$ Overall embedment depth in use categories D and E: $h_{nom,2} (D-E) \geq 55\text{mm}$
	Sleeve	Embedment depth $h_{nom,1}$ =end of corrugated part of sleeve (25mm) Embedment depth $h_{nom,2}$ =circumferential line at sleeve (55mm)

### Setting information

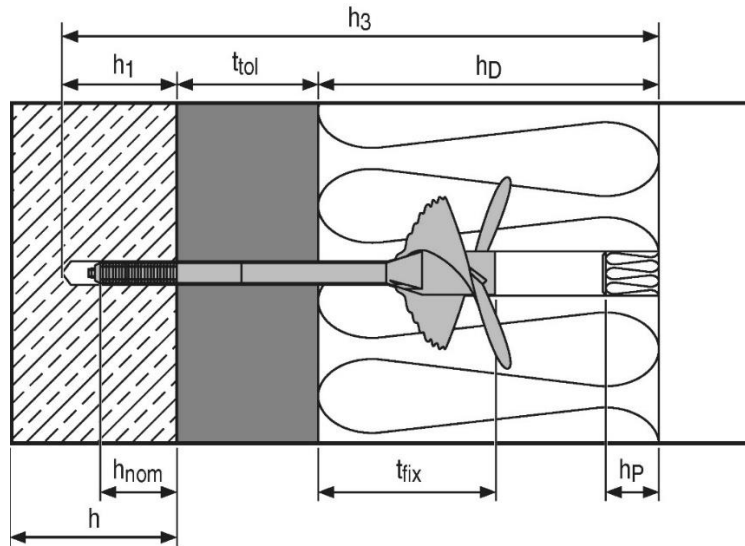

The anchor shall not be exposed to UV-radiation for more than 6 weeks.

### Concrete and solid masonry (use category A, B)

		HTH 8x125	HTH 8x155
Nominal diameter of drill bit	$d_o$ [mm]	8	
Cutting diameter of drill bit	$d_{cut}$ [mm]	8,45	
Minimum depth of drilled hole to the deepest point	$h_1$ [mm]	45	
Overall plastic anchor embedment depth in the base material	$h_{nom,1}$ [mm]	25	
Thickness of fixture	$t_{fix}$ [mm]	80	80
Thickness of equalizing layer for compensation of tolerances or non-loadbearing layer	$t_{tol,min}$ [mm]	0	0
	$t_{tol,max}$ [mm]	20	20
Total length of borehole	$h_3$ [mm]	$h_D+65$	$h_D+95$

**Thin concrete members (e.g. weather resistant skins or external wall panels) and hollow masonry (use category C)**

		HTH 8x125	HTH 8x155
Nominal diameter of drill bit	$d_o$ [mm]	8	
Cutting diameter of drill bit	$d_{cut}$ [mm]	8,45	
Minimum depth of drilled hole to the deepest point	$h_1$ [mm]	45	
Overall plastic anchor embedment depth in the base material	$h_{nom,1}$ [mm]	25	
Thickness of fixture	$t_{fix}$ [mm]	80	80
Thickness of equalizing layer for compensation of tolerances or non-loadbearing layer	$t_{tol,min}$ [mm]	0	0
	$t_{tol,max}$ [mm]	20	20
Total length of borehole	$h_3$ [mm]	$h_D+65$	$h_D+95$

a)  $t_{tol,min}$  may be lower if the anchor performance is tested on site.

**Thin concrete members (e.g. weather resistant skins or external wall panels) and hollow masonry (use category C)**

		HTH 8x125	HTH 8x155
Nominal diameter of drill bit	$d_o$ [mm]	-	8
Cutting diameter of drill bit	$d_{cut}$ [mm]	-	8,45
Minimum depth of drilled hole to the deepest point	$h_1$ [mm]	-	75
Overall plastic anchor embedment depth in the base material	$h_{nom,1}$ [mm]	-	55
Thickness of fixture	$t_{fix}$ [mm]	-	80
Thickness of equalizing layer for compensation of tolerances or non-loadbearing layer	$t_{tol,min}$ [mm]	-	0
	$t_{tol,max}$ [mm]	-	20
Total length of borehole	$h_3$ [mm]	-	$h_D+95$

**Installation equipment**

Anchor	HTH
Rotary hammer	TE 2 – TE 7
Installation	Screw driver SFH 22-A or SF 10W or similar (n=370-600 rpm) Setting tool HTH-SW 1 ( $h_D=100-200mm$ ), HTH-SW 2 ( $h_D=200-360mm$ ) Setting tool D8-SW 1 ( $h_D=100-200mm$ ), D8-SW 2 ( $h_D=200-360mm$ )

**HTH Setting tools**

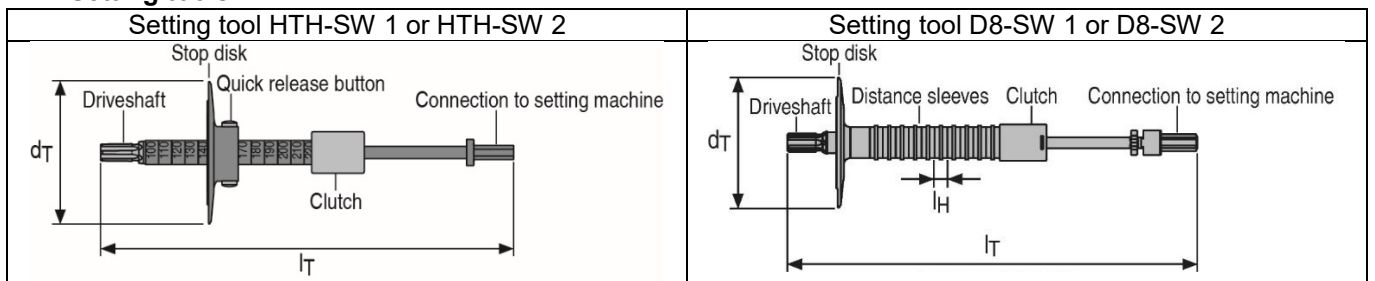

### Setting tool HTH-SW 1 and HTH-SW 2

Setting tool			HTH-SW 1	HTH-SW 2
Diameter of disk	$d_T$	[mm]	100	
Length of the tool	$l_T$	[mm]	310	477
Applicable insulation thickness	$h_{D,min}$	[mm]	100	200
	increment	[mm]	10	
	$h_{D,max}$	[mm]	200	360

### Setting tool D8-SW 1 and D8-SW 2

Setting tool			D8-SW 1	D8-SW 2
Diameter of disk	$d_T$	[mm]	100	
Length of the tool	$l_T$	[mm]	310	477
Length of distance sleeves (insulation thickness increment)	$l_H$	[mm]	10	
Applicable insulation thickness	$h_{D,min}$	[mm]	100	200
	$h_{D,max}$	[mm]	200	360

### Minimum edge distance, minimum spacing and minimum base material thickness

			HTH
Minimum base material thickness	Concrete, masonry, lightweight aggregate concrete and autoclaved aerated concrete	$h_{min}$ [mm]	100
	Thin concrete members (e.g. weather resistant skins of external wall panels)		40
Minimum spacing		$s_{min}$ [mm]	100
Minimum edge distance		$c_{min}$ [mm]	100

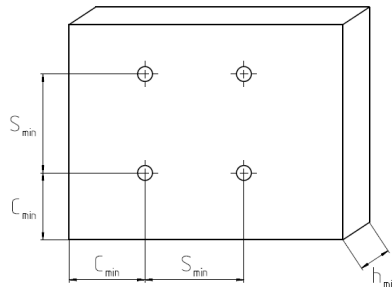

### Setting instruction\*

\*For detailed information on installation see instruction for use given with the package of the product.

Setting instructions	
<b>1. Drill hole with drill bit</b> 	<b>2. Set insulation thickness</b> 
<b>3. Prepare the setting tool</b> click! 	<b>4. Insert fastener by hand</b> 
<b>5. Insert the helix with setting tool</b> 	
<b>6. Cover the whole with the plug or mortar</b> 	

# HTR-P / HTR-M Insulation fastener

## Anchor version



HTR-P  
HTR-M

## Benefits

- Best in class setting comfort and surface finish
- Productivity increase
- Heat transmission class 0 W/K due to screw made of high performance plastic
- Fastening in all base materials of category A, B, C, D and E

## Base material



Concrete

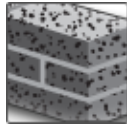

Solid brick

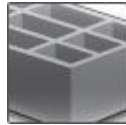

Hollow brick

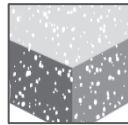

Lightweight  
Aggregate  
concrete

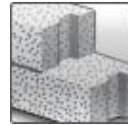

Autoclaved  
Aerated  
concrete

## Other information

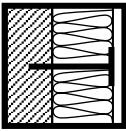

Fastening of  
insulation at the  
wall only



European  
Technical  
Assessment



CE  
conformity

## Approvals/Certificates

Description	Authority / Laboratory	No. / date of issue
European technical assessment <sup>a)</sup>	ZAG, Ljubljana	ETA-16/0116 / 2018-03-28

a) All data given in this section are - if not otherwise indicated - in accordance ETA-16/0116, issue 2018-03-28

## Basic loading data for short term acting loads e.g. wind (for a single anchor)

### All data in this section applies to:

- Correct setting (see setting instruction)
- No edge distance and spacing influence
- Base material as specified in table
- Minimum base material thickness
- Transmission of wind suction loads only
- Redundant fastening in non-cracked concrete
- Anchor and its plate is not exposed to UV-radiation for more than 6 weeks



### Characteristic resistance (short term acting loads)

Base material			HTR-P / HTR-M
Concrete C12/15	$N_{Rk}$	[kN]	1,00
Concrete 16/20 – C50/60	$N_{Rk}$	[kN]	1,50
Thin concrete members (e.g. weather resistant skins of external wall panels) C16/20 – C50/60	$N_{Rk}$	[kN]	1,20
Solid clay brick, Mz 12/2,0	$N_{Rk}$	[kN]	1,20
Solid sand-lime brick, KS 12/1,8	$N_{Rk}$	[kN]	1,50
Vertically perforated clay brick, Hlz 20/1,6	$N_{Rk}$	[kN]	1,20 <sup>a)</sup>
Vertically perforated clay brick, Hlz 12/0,8	$N_{Rk}$	[kN]	0,70 <sup>b)</sup>
Vertically perforated sand-lime brick, KSL 12/1,4	$N_{Rk}$	[kN]	1,20 <sup>a)</sup>
Lightweight Aggregate Concrete $\geq$ LAC4, (raw density $\geq$ 1,4 kg/dm <sup>3</sup> )	$N_{Rk}$	[kN]	0,90
Autoclaved aerated concrete $\geq$ PP4 (raw density $\geq$ 0,5 kg/dm <sup>3</sup> )	$N_{Rk}$	[kN]	0,50 / 0,75 <sup>c)</sup>

a) The value applies only for outer web thickness  $\geq$  20 mm, rotary drilling only

b) The value applies only for outer web thickness  $\geq$  11 mm, rotary drilling only

c) The greater resistance is applicable only with alternative (greater) embedment depth  $h_{nom}=50$ mm

### Design resistance (short term acting loads)

Base material			HTR-P / HTR-M
Concrete C12/15	$N_{Rd}$	[kN]	0,50
Concrete 16/20 – C50/60	$N_{Rd}$	[kN]	0,75
Thin concrete members (e.g. weather resistant skins of external wall panels) C16/20 – C50/60	$N_{Rd}$	[kN]	0,60
Solid clay brick, Mz 12/2,0	$N_{Rd}$	[kN]	0,60
Solid sand-lime brick, KS 12/1,8	$N_{Rd}$	[kN]	0,75
Vertically perforated clay brick, Hlz 20/1,6	$N_{Rd}$	[kN]	0,60 <sup>a)</sup>
Vertically perforated clay brick, Hlz 12/0,8	$N_{Rd}$	[kN]	0,35 <sup>b)</sup>
Vertically perforated sand-lime brick, KSL 12/1,4	$N_{Rd}$	[kN]	0,60 <sup>a)</sup>
Lightweight Aggregate Concrete $\geq$ LAC4, (raw density $\geq$ 1,4 kg/dm <sup>3</sup> )	$N_{Rd}$	[kN]	0,45
Autoclaved aerated concrete $\geq$ PP4 (raw density $\geq$ 0,5 kg/dm <sup>3</sup> )	$N_{Rd}$	[kN]	0,25 / 0,375 <sup>c)</sup>

a) The value applies only for outer web thickness  $\geq$  20 mm, rotary drilling only

b) The value applies only for outer web thickness  $\geq$  11 mm, rotary drilling only

c) The greater resistance is applicable only with alternative (greater) embedment depth  $h_{nom}=50$ mm

### Recommended loads (short term acting loads)

Base material			HTR-P / HTR-M
Concrete C12/15	$N_{Rd}$	[kN]	0,33
Concrete 16/20 – C50/60	$N_{Rd}$	[kN]	0,50
Thin concrete members (e.g. weather resistant skins of external wall panels) C16/20 – C50/60	$N_{Rd}$	[kN]	0,40
Solid clay brick, Mz 12/2,0	$N_{Rd}$	[kN]	0,40
Solid sand-lime brick, KS 12/1,8	$N_{Rd}$	[kN]	0,50
Vertically perforated clay brick, Hlz 20/1,6	$N_{Rd}$	[kN]	0,40 <sup>a)</sup>
Vertically perforated clay brick, Hlz 12/0,8	$N_{Rd}$	[kN]	0,23 <sup>b)</sup>
Vertically perforated sand-lime brick, KSL 12/1,4	$N_{Rd}$	[kN]	0,40 <sup>a)</sup>
Lightweight Aggregate Concrete $\geq$ LAC4, (raw density $\geq$ 1,4 kg/dm <sup>3</sup> )	$N_{Rd}$	[kN]	0,30
Autoclaved aerated concrete $\geq$ PP4 (raw density $\geq$ 0,5 kg/dm <sup>3</sup> )	$N_{Rd}$	[kN]	0,167 / 0,25 <sup>c)</sup>

a) The value applies only for outer web thickness  $\geq$  20 mm, rotary drilling only

b) The value applies only for outer web thickness  $\geq$  11 mm, rotary drilling only

c) The greater resistance is applicable only with alternative (greater) embedment depth  $h_{nom}=50$ mm

**Recommended pull-through (short term acting) loads in different insulation materials <sup>a)</sup>**

Insulation	Thickness [mm]	Plate-Ø [mm]	Pull-through load [kN]
Expanded polystyrene EPS	60 - 119	≥ 60	0,15
Expanded polystyrene EPS	120 - 260	≥ 60	0,20
Mineral wool, type HD	60 - 260	≥ 60	0,15
Mineral wool, type WV	60 - 260	≥ 90	0,15 <sup>b)</sup>
Mineralwolle, type lamella	60 - 260	≥ 140	0,167 <sup>c)</sup>

a) This technical data are not covered by ETA-16/0116. They are based on an HILTI-internal assessment of test data. Recommended values can be used in case that the insulation material to be fastened is not covered by a European Technical Assessment (ETA) or any national approval document. If the ETICS to be fastened is covered by an ETA or any national approval document, the given pull-through resistance in the ETA or national approval document is applicable. The design of anchorages has to be carried out in accordance to EAD 330196-01-0604 and ETAG 004 or EAD 040083-00-0404 or applicable national regulation under the responsibility of an engineer experienced in anchorages.

b) HILTI slip-on plate HDT 90 must be used

c) HILTI slip-on plate HDT 140 must be used

**Basic provisions for dead loads on the bottom side of ceilings (for a single anchor)**
**All data in this section applies to**

- Correct setting (see setting instruction)
- No edge distance and spacing influence
- Base material as specified in the table
- Minimum base material thickness
- Quasi-static permanent loads only
- Redundant fastening in non-cracked and cracked concrete
- Anchor and its plate is not exposed to UV-radiation for more than 6 weeks

Note: Pull-through resistance of panel and its bending resistance shall be proven by panel manufacturer or any other person experienced in the design of such panels. Drawings of fixing positions shall be provided to the operator. Each panel shall be fixed with 4 anchors at least.

**Recommended number of anchors for fixing panels to ceilings w/o consideration of wind loads<sup>a)</sup>:**

Specific panels weight	Number of anchors per m <sup>2</sup>
≤ 29 kg/m <sup>2</sup>	4
≤ 43 kg/m <sup>2</sup>	6
≤ 57 kg/m <sup>2</sup>	8
≤ 71 kg/m <sup>2</sup>	10

a) This technical data are not covered by ETA-16/0116. They are based on an HILTI-internal assessment of test data. A safety factor for dead load  $\gamma_F=1,35$  and a safety factor  $\gamma_M=1,80$  for material is considered.

**Point thermal transmittance**

	Insulation thickness [mm]	Point thermal transmittance $\chi$ [W/K]
HTR-P / HTR-M	60 - 260	0,000

**Plate Stiffness and plate capacity**

	Plate diameter [mm]	Capacity of plate [kN]	Plate stiffness [kN/mm]
HTR-P / HTR-M	Ø 60	1,4	0,6

### Service temperature range

	Base material temperature	Maximum long term base material temperature	Maximum short term base material temperature
Temperature range I	0 °C to +40 °C	+24 °C	+40 °C

### Maximum short-term base material temperature

Short-term elevated base material temperatures are those that occur over brief intervals, e.g. because of diurnal cycling.

### Maximum long-term base material temperature

Long-term elevated base material temperatures are roughly constant over significant periods of time.

### Materials, dimensions, designations

Part		Material
Anchor sleeve		Polyethylene, black
Anchor plate		Polypropylene, red
Expansion plastic screw	HTR-P	Polyamide, glass fiber reinforced 50%, black
Composite screw	HTR-M	Expansion element: steel, galvanized Shank: polyamide, glass fiber reinforced, black
Slip-on plate	HDT 90	Polypropylene, glass fiber reinforced, white
Slip-on plate	HDT 140	Polyamide, glass fiber reinforced, white

### HTR-P

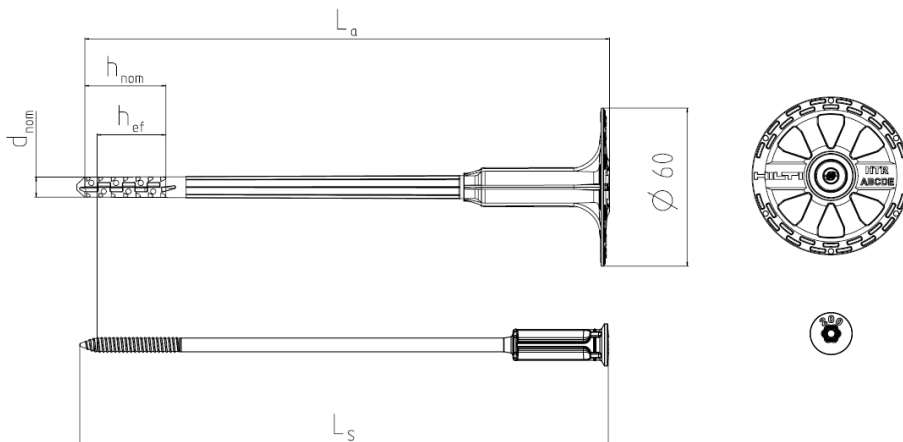

### HTR-M

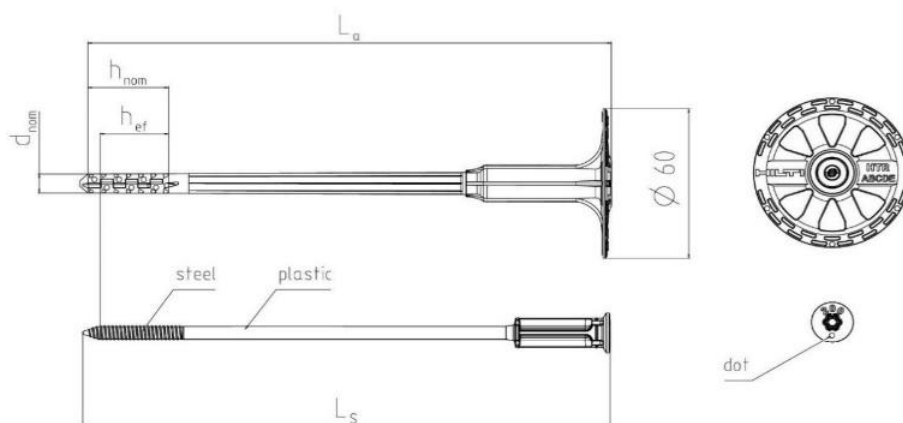

### Anchor dimensions

		HTR-P / HTR-M
Diameter of sleeve	$d_{nom}$ [mm]	8
Minimum length of anchor body	$L_{a,min}$ [mm]	100
Maximum length of anchor body	$L_{a,max}$ [mm]	300
Minimum length of screw	$L_{S,min}$ [mm]	101
Maximum length of screw	$L_{S,max}$ [mm]	301

### Anchor designations

		HTR-P / HTR-M
Expansion screw	Top of head	HTR-P: Anchor length $L_a$ (e.g. "300") HTR-M: Anchor length $L_a$ (e.g. "300" and a dot ●)
Plate	Top of plate	Producer: HILTI
		Anchor type: HTR
	Bottom side of plate	Base material categories: A, B, C, D, E Nominal embedment depth: $h_{nom}=30$ mm for base material categories A, B, C, D, E Nominal drill bit diameter: 8 mm

### Setting information

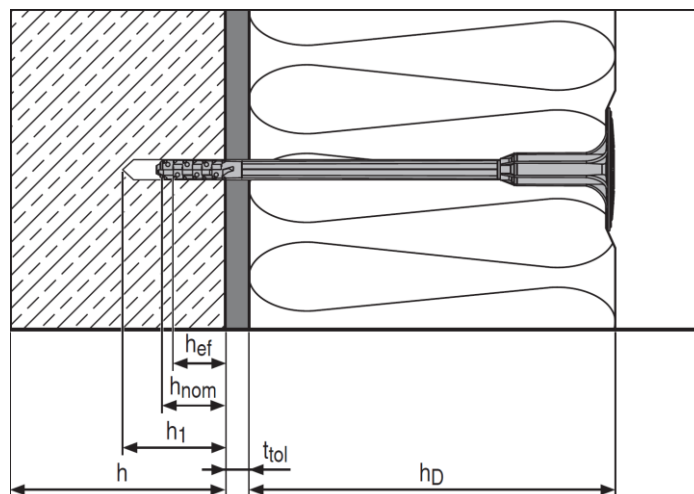

### Setting details:

		HTR-P / HTR-M	
		Base material category A, B, C, D and E	Base material category E <sup>a)</sup>
Nominal diameter of drill bit	$d_o$ [mm]	8	
Cutting diameter of drill bit	$d_{cut} \leq$ [mm]	8,45	
Depth of drill hole	$h_1 \geq$ [mm]	40	40
Effective anchorage depth	$h_{ef}$ [mm]	25	25
Overall embedment depth	$h_{nom}$ [mm]	30	30
Thickness of insulation	$h_D$ [mm]	60 to 260	60 to 260
Maximum thickness of tolerance layer	$t_{tol,max}$ [mm]	$L_a - h_{nom} - h_D^{b)}$	
Installation temperature	[°C]	0 to +40	
Exposure to UV-radiation		$\leq 6$ weeks	

a) In base material category E (autoclaved aerated concrete PP4) an alternative embedment depth  $h_{nom}=50$ mm with greater resistance is available

b)  $L_a$  ... Anchor length,  $h_{nom}$  ... Overall embedment depth,  $h_D$  ... Thickness of insulation

Example:

HTR-P 8x300 or HTR-M 8x300:  $L_a = 300$ mm;  $h_{nom} = 30$ mm;  $h_D = 260$ mm

$t_{tol,max} = 300$ mm - 30mm - 260mm = 10mm

### Installation equipment

	HTR-P / HTR-M
Rotary hammer	Corded: HILTI TE 2 – TE 7 Battery: HILTI TE2-A22, TE4-A22, TE6-A36
Installation	Electrical screw driver e.g. HILTI SF 2-A + TX30 The use of setting tool SW-HTR is recommended

### Minimum edge distance, minimum spacing and minimum base material thickness

	HTR-P / HTR-M	
Minimum base material thickness	$h_{min}$ [mm]	100 <sup>a)</sup>
Minimum spacing	$s_{min}$ [mm]	100
Minimum edge distance	$c_{min}$ [mm]	100

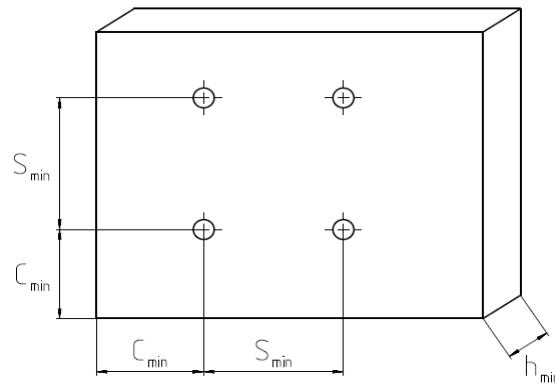

a) Except for thin concrete members (e.g. weather resistant skins of external walls) with  $h_{min}=40mm$ ). The belonging characteristic resistance must be considered.

### Setting instruction\*

\*For detailed information on installation see instruction for use given with the package of the product.

Setting instructions	
<p>1. Drill hole with drill bit</p>	<p>2. Insert the fastener by hand</p>
<p>3. Make sure that anchor's plate is in touch with insulation panel's surface</p>	<p>4. Use screw driver with setting tool to insert the fastener</p>
<p>5. Check correct setting</p>	

# T-Save HTS-P / HTS-M Insulation fastener

## Anchor version



T-Save HTS-P  
T-Save HTS-M

## Benefits

- Fastening in all base materials of category A, B, C, D and E
- Easy and fast to install
- Best insulation surface finish
- Heat transmission class 0,000 W/K

## Base material



Concrete (non-cracked)

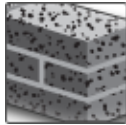

Solid brick

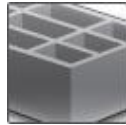

Hollow brick

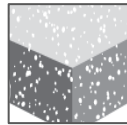

Lightweight Aggregate concrete

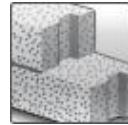

Autoclaved aerated concrete

## Other information

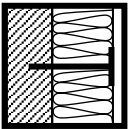

Fastening of insulation



European Technical Assessment



CE conformity

## Approvals/Certificates

Description	Authority / Laboratory	No. / date of issue
European technical assessment <sup>a)</sup>	ZAG, Ljubljana	ETA-14/0400 / 2017-06-23

## Basic loading data for short term acting loads e.g. wind (for a single anchor)

### All data in this section applies to:

- Correct setting (see setting instruction)
- No edge distance and spacing influence
- Redundant fastenings in the base materials as specified in the tables
- Minimum base material thickness or greater
- Transmission of wind suction loads only
- Anchor and its plate is not exposed to UV-radiation for more than 6 weeks

### Characteristic resistance (short term acting load)

Base material		T-Save HTS-P / T-Save HTS-M
Concrete $\geq$ C12/15	$N_{Rk}$ [kN]	0,9
Solid clay brick Mz 12/2,0	$N_{Rk}$ [kN]	0,9
Solid sand-lime brick KS 12/1,8	$N_{Rk}$ [kN]	0,9
Vertically perforated clay brick Hz 20/1,6	$N_{Rk}$ [kN]	0,75 <sup>a)</sup>
Vertically perforated sand-lime brick KSL 12/1,4	$N_{Rk}$ [kN]	0,75 <sup>a)</sup>
Lightweight Aggregate Concrete $\geq$ LAC4 (raw density $\geq$ 1,4 kg/dm <sup>3</sup> )	$N_{Rk}$ [kN]	0,60
Autoclaved aerated concrete $\geq$ PP4 (raw density $\geq$ 0,5 kg/dm <sup>3</sup> )	$N_{Rk}$ [kN]	0,40

a) The value applies only for outer web thickness  $\geq$  20 mm, rotary drilling only

### Design resistance (short term acting load)

Base material		T-Save HTS-P / T-Save HTS-M
Concrete $\geq$ C12/15	$N_{Rd}$ [kN]	0,45
Solid clay brick Mz 12/2,0	$N_{Rd}$ [kN]	0,45
Solid sand-lime brick KS 12/1,8	$N_{Rd}$ [kN]	0,45
Vertically perforated clay brick Hz 20/1,6	$N_{Rd}$ [kN]	0,375 <sup>a)</sup>
Vertically perforated sand-lime brick KSL 12/1,4	$N_{Rd}$ [kN]	0,375 <sup>a)</sup>
Lightweight Aggregate Concrete $\geq$ LAC4 (raw density $\geq$ 1,4 kg/dm <sup>3</sup> )	$N_{Rd}$ [kN]	0,30
Autoclaved aerated concrete $\geq$ PP4 (raw density $\geq$ 0,5 kg/dm <sup>3</sup> )	$N_{Rd}$ [kN]	0,20

a) The value applies only for outer web thickness  $\geq$  20 mm, rotary drilling only

### Recommended loads (short term acting load)

Base material		T-Save HTS-P / T-Save HTS-M
Concrete $\geq$ C12/15	$N_{Rec}$ [kN]	0,3
Solid clay brick Mz 12/2,0	$N_{Rec}$ [kN]	0,3
Solid sand-lime brick KS 12/1,8	$N_{Rec}$ [kN]	0,3
Vertically perforated clay brick Hz 20/1,6	$N_{Rec}$ [kN]	0,25 <sup>a)</sup>
Vertically perforated sand-lime brick KSL 12/1,4	$N_{Rec}$ [kN]	0,25 <sup>a)</sup>
Lightweight Aggregate Concrete $\geq$ LAC4 (raw density $\geq$ 1,4 kg/dm <sup>3</sup> )	$N_{Rec}$ [kN]	0,20
Autoclaved aerated concrete $\geq$ PP4 (raw density $\geq$ 0,5 kg/dm <sup>3</sup> )	$N_{Rec}$ [kN]	0,13

a) The value applies only for outer web thickness  $\geq$  20 mm, rotary drilling only



### Recommended (short term) pull-through loads in different insulation materials <sup>a)</sup>

Base material	Thickness [mm]	Plate-Ø [mm]	Pull-through load [kN]
Expanded polystyrene EPS	60-100	≥ 60	0,15
Expanded polystyrene EPS	120-260	≥ 60	0,20
Mineral wool, type HD	60-260	≥ 60	0,15
Mineral wool, type WV	60-260	≥ 90	0,15 <sup>b)</sup>
Mineral wool, type lamella	60-260	≥ 140	0,167 <sup>c)</sup>

a) Recommended values in case that the insulation material to be fixed is not covered by a European Technical Assessment (ETA) or any national approval document. If the ETICS to be fixed is covered by an ETA or any national approval document, the given pull-through resistance in the ETA or national approval document is applicable. The design of anchorages must be carried out in accordance to EAD330196-01-0604 and ETAG 004 or applicable national regulation under the responsibility of an engineer experienced in anchorages.

b) HILTI slip-on plate HDT 90 must be used

c) HILTI slip-on plate HDT 140 must be used

### Basic provisions for fixing insulation on the bottom side of ceilings

#### All data in this section applies to

- Correct setting (see setting instruction)
- No edge distance and spacing influence
- Redundant fastening in non-cracked concrete
- Minimum base material thickness or greater
- Transmission of quasi-static permanent loads only
- Anchor and its plate is not exposed to UV-radiation for more than 6 weeks

Note: Each panel shall be supported by 4 anchors at least e.g. by T-joint fixing.

#### Recommended number of anchors for fixing panels to ceilings w/o consideration of wind load<sup>a)</sup>:

Specific panels weight	Number of anchors per m <sup>2</sup>
EPS (≤30 kg/m <sup>3</sup> , TR≥100 kPa, 60mm≤thickness≤260)	4
Mineral wool (≤120 kg/m <sup>3</sup> , TR≥3.5 kPa, 60mm≤thickness≤120mm)	
Mineral wool (≤150 kg/m <sup>3</sup> , TR≥3.5 kPa, 60mm≤thickness≤100mm)	
Mineral wool (≤200 kg/m <sup>3</sup> , TR≥3.5 kPa, 60mm≤thickness≤70mm)	5

a) These technical data are not covered by ETA-14/0400. They are based on a HILTI-internal assessment. A safety factor for dead load  $\gamma_F=1,35$ , a safety factor  $\gamma_{M, EPS}=1,50$ , a safety factor  $\gamma_{M, Mineralwool}=2,00$  for material is considered.

#### Point thermal transmittance

Base material	Thickness [mm]	Point thermal transmittance $\chi$ [W/K]
Insulation	60-260	0,000

#### Plate Stiffness and plate capacity

Base material	Thickness [mm]	Capacity of plate [kN]	Plate stiffness [kN/mm]
Insulation	60-260	1,4	0,6

### Service temperature range

	Base material temperature	Maximum long term base material temperature	Maximum short term base material temperature
Temperature range	0 °C to +40 °C	+24 °C	+40 °C

### Maximum short term base material temperature

Short-term elevated base material temperatures are those that occur over brief intervals, e.g. because of diurnal cycling.

### Maximum long term base material temperature

Long-term elevated base material temperatures are roughly constant over significant periods of time.

## Materials

### Material quality

Part		Material
Anchor sleeve	HTS-P and HTS-M	Polyethylene, black
Anchor plate	HTS-P und HTS-M	Polypropylene, white
Expansion pin	HTS-P	Polyamide, fiber reinforced 50%, black
Expansion pin	HTS-M	Expansion element: steel Shaft: polyamide, fiber reinforced 50%, black
Slip-on plate	HDT 90	Polypropylene, fiber reinforced, white
Slip-on plate	HDT 140	Polyamide, fiber reinforced, white

### T-Save HTS-P

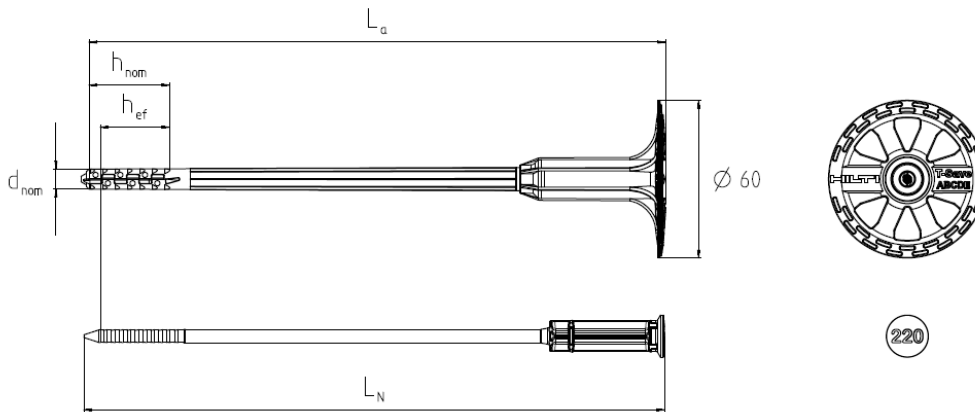

### T-Save HTS-M

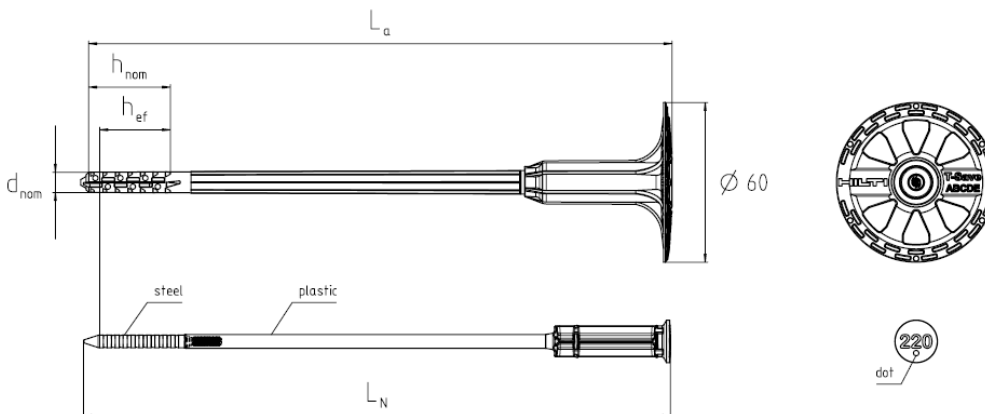

### Anchor dimensions

		T-Save HTS-P / T-Save HTS-M
Diameter of sleeve	$d_{nom}$ [mm]	8
Minimum length of anchor body	$L_{a,min}$ [mm]	100
Maximum length of anchor body	$L_{a,max}$ [mm]	300
Minimum length of pin	$L_{N,min}$ [mm]	101
Maximum length of pin	$L_{N,max}$ [mm]	301

### Anchor designations

		T-Save HTS-P / T-Save HTS-M
Expansion screw	Top of head	T-Save HTS-P: Anchor length $L_a$ (e.g. "220") T-Save HTS-M: Anchor length $L_a$ (e.g. "220" and a dot •)
Plate	Top of plate	Producer: HILTI
		Anchor type: T-Save
	Bottom side of plate	Base material categories: A, B, C, D, E Nominal embedment depth: $h_{nom}=30$ mm for base material categories A, B, C, D, E Nominal drill bit diameter: 8 mm

### Setting information

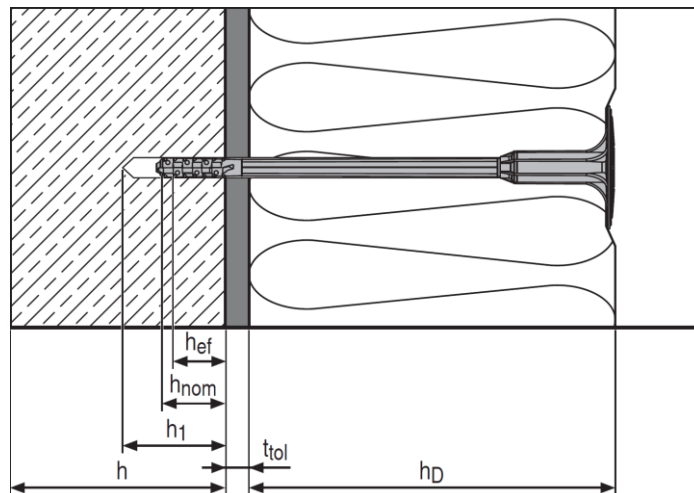

### Setting details:

		T-Save HTS-P / T-Save HTS-M
Nominal diameter of drill bit	$d_o$ [mm]	8
Cutting diameter of drill bit	$d_{cut} \leq$ [mm]	8,45
Depth of drill hole	$h_1 \geq$ [mm]	40
Effective anchorage depth	$h_{ef}$ [mm]	25
Overall embedment depth	$h_{nom}$ [mm]	30
Thickness of insulation	$h_D$ [mm]	60 to 260
Maximum thickness of tolerance layer	$t_{tol,max}$ [mm]	$L_a - h_{nom} - h_D^{a)}$
Installation temperature	[°C]	0 to +40
UV exposure		$\leq 6$ weeks

- a)  $L_a$  ... Anchor length,  $h_{nom}$  ... Overall embedment depth,  $h_D$  ... Thickness of insulation  
 Example:  
 T-Save HTS 8x220-P:  $L_a = 220$ mm;  $h_{nom} = 30$ mm;  $h_D = 180$ mm  
 $t_{tol,max} = 220 - 30 - 180 = 10$ mm

### Installation equipment

Anchor size	T-Save HTS-P / T-Save HTS-M
Rotary hammer	Corded: HILTI TE 2 – TE 7 Battery: HILTI TE2-A22, TE4-A22, TE6-A36
Installation	Hammer 500g to 1500g

### Minimum edge distance, minimum spacing and minimum base material thickness

		T-Save HTS-P / T-Save HTS-M
Minimum base material thickness	$h_{min}$ [mm]	100
Minimum spacing	$S_{min}$ [mm]	100
Minimum edge distance	$C_{min}$ [mm]	100

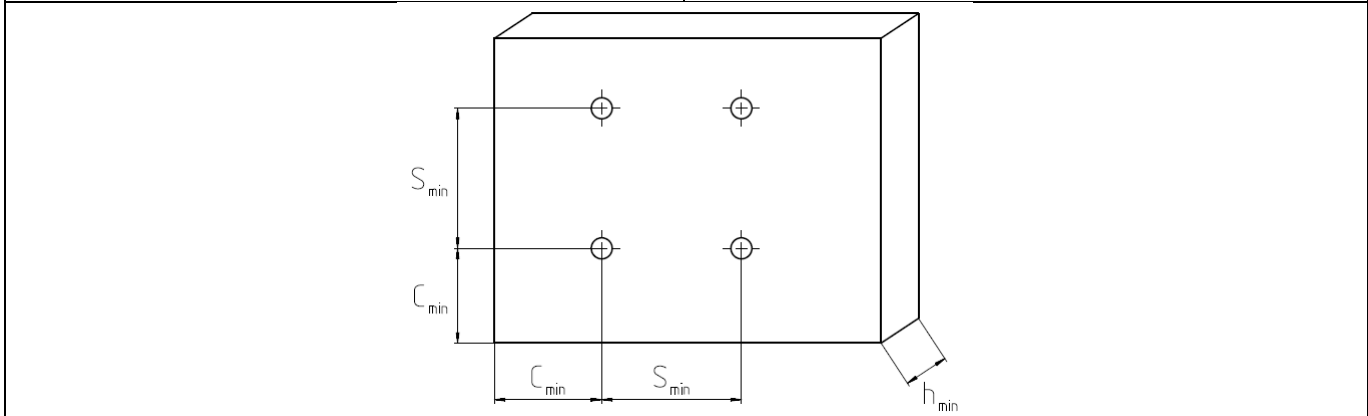

### Setting instruction\*

\*For detailed information on installation see instruction for use given with the package of the product.

Setting instructions	
<b>1. Drill hole with drill bit</b> 	<b>2. Insert the fastener by hand</b> 
<b>3. Tap fastener with a hammer</b> 	<b>4. Check correct setting</b> 

# IDP Insulation fastener

## Anchor version



IDP

## Benefits

- For insulation up to 15 cm
- Simple setting

## Base material



Concrete  
(non-cracked)

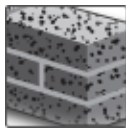

Solid brick

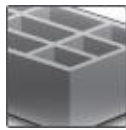

Hollow brick

## Other information

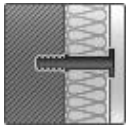

Fastening of  
insulation at the  
wall only

## Basic loading data (for a single anchor)

### All data in this section applies to:

- Correct setting (see setting instruction)
- No edge distance and spacing influence
- Base material as specified in table
- Minimum base material thickness
- Loads shall be reduced and number of fasteners shall be increased if temperature sustains above 40°C

### Recommended loads <sup>a)</sup>

Base material			IDP
Concrete $\geq$ C16/20	$N_{rec}$	[kN]	0,14
Solid clay brick Mz 20 – 1,8 – NF	$N_{rec}$	[kN]	0,14
Solid sand-lime brick KS 12 – 1,6 – 2DF	$N_{rec}$	[kN]	0,14
Hollow clay brick Hz 12 – 0,8 – 6DF	$N_{rec}$	[kN]	0,04 <sup>b)</sup>
Hollow sand-lime brick KSL 12 – 1,4 – 3DF	$N_{rec}$	[kN]	0,04

a) With overall global safety factor  $\gamma = 5$  to the characteristic loads and a partial safety factor of  $\gamma = 1,4$  to the design values.

b) Drilling without hammering

## Materials

### Material quality

Part	Material
Anchor with plate	Polypropylene

## Setting information

### Setting details

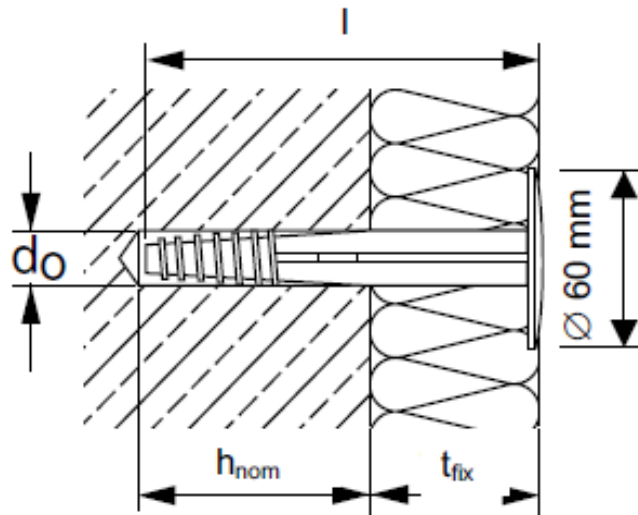

Anchor size		0/2	2/4	4/6	6/8	8/10	10/12	13/15
Nominal diameter	$d_0$ [mm]	8						
Cutting diameter of drill bit	$d_{cut} \leq$ [mm]	8,45						
Depth of drill hole	$h_1 \geq$ [mm]	$l - t_{fix} + 10\text{mm} \geq 40\text{mm}$						
Nominal anchorage depth	$h_{nom}$ [mm]	25						
Anchor length	$l$ [mm]	50	70	90	110	130	150	180
Maximum thickness of fixture	$t_{fix}$ [mm]	20	40	60	80	100	120	150
Installation temperature	[°C]	0 up to 40						

### Installation equipment

Anchor size	IDP
Rotary hammer	Corded: HILTI TE 2 – TE 7 Battery: HILTI TE2-A22, TE4-A22, TE6-A36
Other tools	Hammer

### Setting instruction\*

\*For detailed information on installation see instruction for use given with the package of the product.

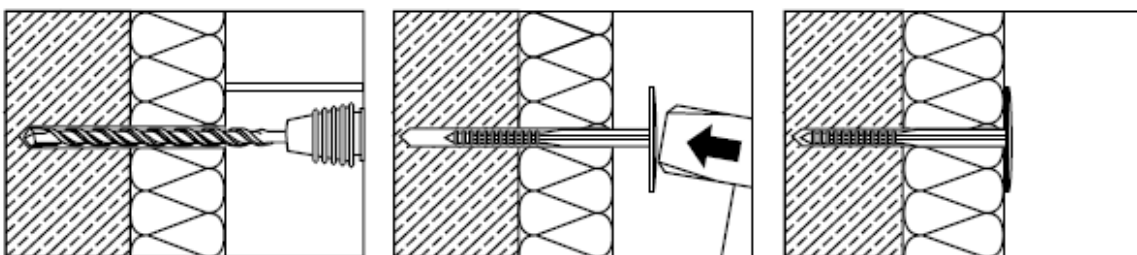

Drill hole with drill bit.

Tap in fastener with a hammer.





## **Acknowledgements**

To Luis Pombo, Martina Rajniakova, Michael Roessle, Miriam Campillo, Zhiar Azad and Guillermo Ortiz: without them, the release of this FTM would not have been possible.



Hilti Corporation  
9494 Schaan, Liechtenstein

**Edition February 2020 / 403736**

[www.facebook.com/hiltigroup](https://www.facebook.com/hiltigroup)  
[www.hilti.group](https://www.hilti.group)